

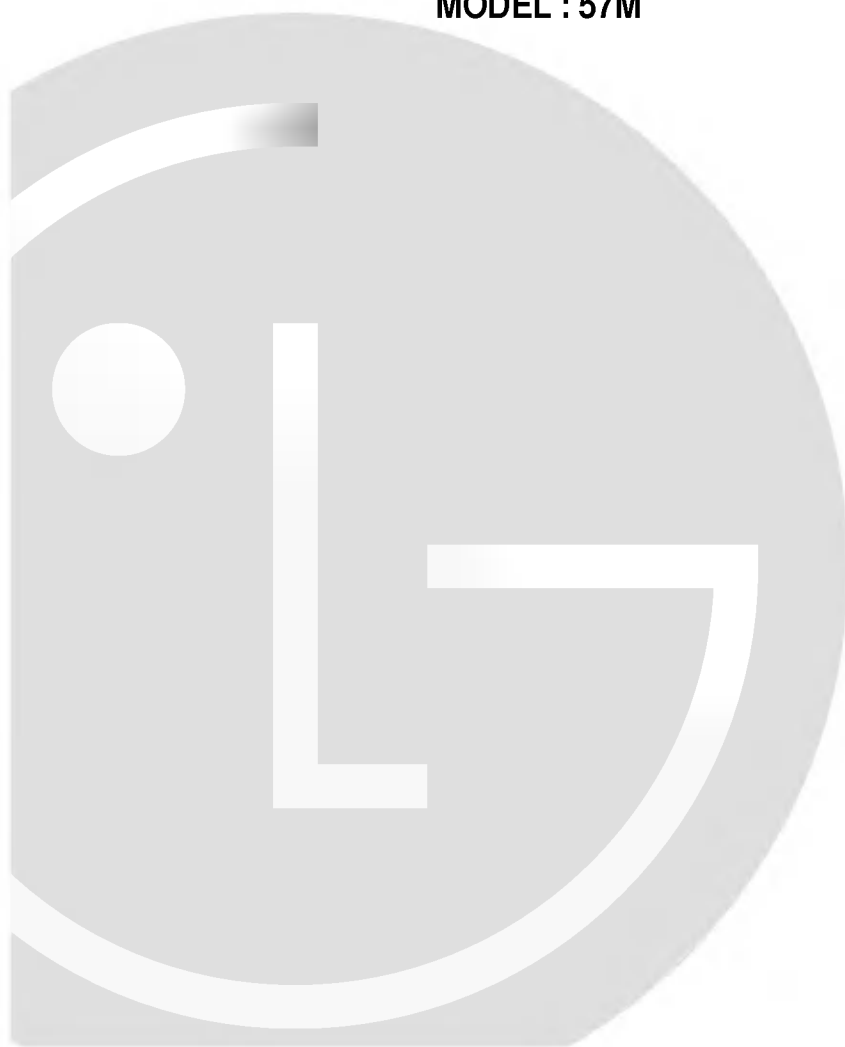

# Color Monitor

USER GUIDE  
MANUEL D'UTILISATION

MODEL : 57M



## **FCC Compliance Statement**

This equipment has been tested and found to comply with the limits for a Class B digital device pursuant to Part 15 of the FCC Rules. These limits are designed to provide reasonable protection against harmful interference in a residential installation.

This equipment generates, uses, and can radiate radio frequency energy and if not installed and used in accordance with the instructions, may cause harmful interference to radio communications. However, there is no guarantee that interference will not occur in a particular installation.

If this equipment does cause harmful interference to radio or television reception (which can be determined by turning the equipment off and on), the user is encouraged to try to correct the interference by using one or more of the following measures:

- Reorient or relocate the receiving antenna.
- Increase the separation between the equipment and the receiver.
- Connect the equipment into an outlet on a circuit different from that to which the receiver is connected.
- Consult the dealer or an experienced radio/TV technician for help.

**Caution:** Changes or modifications not expressly approved by LG Electronics Inc. for compliance could void the user's (or your) authority to operate the equipment. Only peripherals (digital input/output devices, terminals, printers, etc.) certified to comply with the Class B limits may be attached to this monitor. Operation with non-certified peripherals is likely to result in interference to radio and TV reception.

Only shielded Signal Cables may be used with this System.

### **Canadian D. O. C. Notice**

This Class B digital apparatus meets all requirements of the Canadian Interference-Causing Equipment Regulations.

Cet appareil numérique de la classe B respecte toutes les exigences du Règlement sur le matériel brouilleur du Canada.

## Table of Contents

Introduction.....	A1
Monitor Registration .....	A2
Important Precautions .....	A3
Installing the Tilt/Swivel Base.....	A5
Installation .....	A6
Location and Function of Controls.....	A7
Control Panel Function.....	A8
On Screen Display (OSD) Control Adjustment.....	A9
On Screen Display (OSD) Selection and Adjustment .....	A10
Sound Selection and Adjustment .....	A14
Power Management System .....	A15
Video Memory Modes .....	A16
Microphone Operation.....	A18
Audio Features .....	A18
Audio Connections .....	A18
Low Radiation Compliance (MPR II) .....	A19
Self Diagnostics.....	A19
DDC (Display Data Channel) .....	A19
Troubleshooting.....	A20
Service .....	A21
Specifications .....	A22
Monitor Limited Warranty .....	A24

## **Introduction**

Thank you for purchasing an **LG** color monitor. This monitor supports OSD, DDC2B and Sound. It will give you high resolution performance and operation in a variety of video operating modes. It is compatible with standard PC type personal computers. The 15-inch (13.8 inches viewable) flat Square Tube design is excellent for use in a Windows or desktop publishing environment, where smaller screen sizes result in images difficult to see easily. The anti-glare treatment is easy on the eyes.

The microprocessor-based On Screen Display (OSD) controls allow you to adjust a variety of image controls, automatically storing up to 37 different video modes, including 6 pre-set modes.

For greater user health and safety, this monitor complies with the Swedish Nutek MPR II requirements for low radiation emissions.

For low cost of monitor operation, this monitor is certified as meeting the EPA Energy Star Requirements, and utilizes the VESA Display Power Management Signalling (DPMS) protocol.

Please review this manual completely before operating the monitor.

## Monitor Registration

The model and serial numbers are found on the rear of this unit. These numbers are unique to this unit and not available to others. You should record requested information here and retain this guide as a permanent record of your purchase. Staple your receipt here.

Date of Purchase : \_\_\_\_\_  
Dealer Purchased From : \_\_\_\_\_  
Dealer Address : \_\_\_\_\_  
Dealer Phone No. : \_\_\_\_\_  
Model No. : \_\_\_\_\_  
Serial No. : \_\_\_\_\_

## Notice

All rights reserved. Reproduction in any manner, in whole or in part, is strictly prohibited without the written permission of LG Electronics Inc.

## Trademark Acknowledgments

**LG** is a trademark of **LG Electronics Inc.**

**IBM** is a registered trademark and **VGA** is a trademark of International Business Machines Corporation.

---

**WARNING** : To reduce the risk of fire or electric shock, do not expose this appliance to rain or moisture.

**AVERTISSEMENT** : Ne pas placer cet appareil dans un endroit humide. Cela peut entraîner un incendie ou une décharge électrique.

## Important Precautions

This unit has been engineered and manufactured to assure your personal safety, but improper use can result in potential electrical shock or fire hazard. In order not to defeat the safeguards incorporated in this monitor, observe the following basic rules for its installation, use, and servicing. Also follow all warnings and instructions marked directly on your monitor.

### On safety

1. Use only the power cord supplied with the unit. In case you use another power cord, make sure that it is certified by the applicable standards (UL/CSA or VDE) if not being provided by the supplier.
2. Operate the monitor only from a power source indicated in the specifications of this manual or listed on the monitor. If you are not sure what type of power supply you have in your home, consult with your dealer.
3. Overloaded AC outlets and extension cords are dangerous. So are frayed power cords and broken plugs. They may result in a shock or fire hazard. Call your service technician for replacement.
4. **DO NOT OPEN THE MONITOR.** There are no user serviceable components inside. There are Dangerous High Voltages inside, even when the power is OFF. Contact your dealer if the monitor is not operating properly.
5. To avoid personal injury :
  - Do not place the monitor on a sloping shelf unless properly secured.
  - Use only a stand recommended by the manufacturer.
  - Do not try to roll a stand with small casters across thresholds or deep pile carpets.
6. To prevent Fire or Hazards:
  - Always turn the monitor OFF if you leave the room for more than a short period of time. Never leave the monitor ON when leaving the house.

- Keep children from dropping or pushing objects into the monitor's cabinet openings. Some internal parts carry hazardous voltages.
- Do not add accessories that have not been designed for this monitor.
- During a lightning storm or when the monitor is to be left unattended for an extended period of time, unplug it from the wall outlet.
- Do not bring magnetic devices such as magnets or motors near the picture tube.

#### **On installation**

1. Do not allow anything to rest upon or roll over the power cord, and do not place the monitor where the power cord is subject to damage.
2. Do not use this monitor near water such as near a bathtub, washbowl, kitchen sink, laundry tub, in a wet basement, or near a swimming pool.
3. Monitors are provided with ventilation openings in the cabinet to allow the release of heat generated during operation. If these openings are blocked, built-up heat can cause failures which may result in a fire hazard. Therefore, NEVER:
  - Block the bottom ventilation slots by placing the monitor on a bed, sofa, rug, etc.
  - Place the monitor in a built-in enclosure unless proper ventilation is provided.
  - Cover the openings with cloth or other material.
  - Place the monitor near or over a radiator or heat source.

#### **On cleaning**

- Unplug the monitor before cleaning the face of the picture tube.
- Use a slightly damp (not wet) cloth. Do not use an aerosol directly on the picture tube because overspray may cause electrical shock.

#### **On repacking.**

- Do not throw away the carton and packing materials. They make an ideal container in which to transport the unit. When shipping the unit to another location, repack it in its original material.

## **Installing the Tilt/Swivel Base**

- Turn off the equipment and all attached options.
- Carefully set the monitor face-down with the underside facing you.

### **Installation**

1. Align the hooks on the tilt/swivel stand with the matching slot on the base (underside of the monitor). The open hooks of the stand should face the front of the monitor. The matching slots are on the first row of slots showing 2 pairs of slots.
2. Insert the hooks into the front and rear slots. The stand should now fit flush with the bottom of the monitor.
3. Slide the stand toward the front of the monitor, until the latch clicks into the locked position. Now only the bottom of the stand should be movable.
4. Carefully upright the monitor, taking care to place the monitor down flatly on an even surface.

**NOTE:** To remove the stand, gently push in the latch on the bottom of the monitor and then slide the stand toward the back of the monitor. After sliding the stand back, lift off the stand from the monitor.



## **Installation**

The supply voltage is marked on the ID label located on the rear panel of the monitor. If your local voltage is different, do not use the monitor and contact your supplier before using the display.

## **Connections**

To connect your monitor after the video adapter is properly installed:

1. Turn OFF the power to your computer and all its attached options.
2. Position the monitor and the computer so that you can easily get to the back panel of each.
3. Connect the signal cable with D-sub connector to the graphics board on your PC as described in your PC Owner's Manual.
4. Tighten the screws on the video cable connectors to keep them from coming loose and to prevent radio and TV interference.
5. Connect the power cord to the AC receptacle on the back of the monitor. Plug the other end of the power cord into a properly grounded electrical outlet.
6. The socket-outlet should be installed near the equipment and should be easily accessible.

## Location and Function of Controls

### Front View

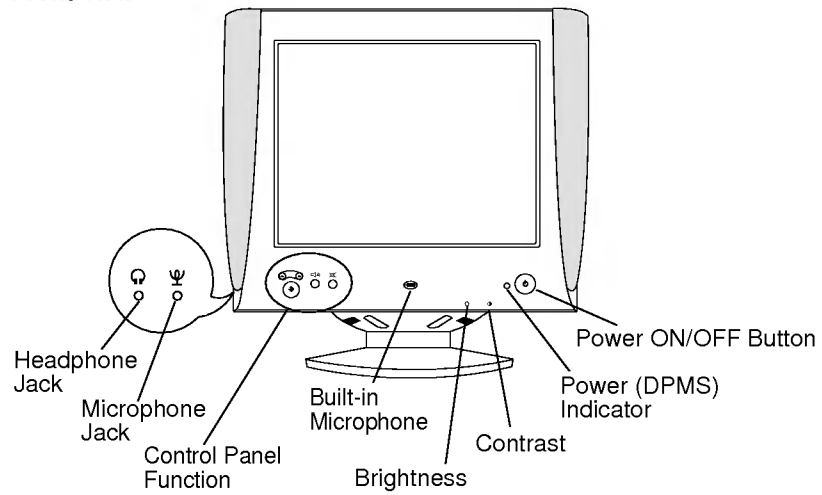

### Rear View

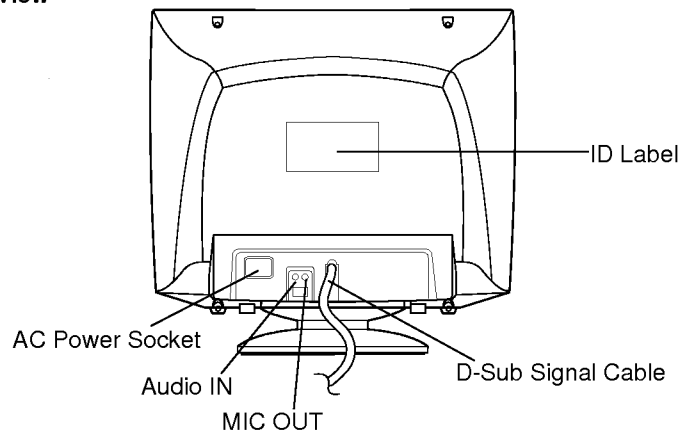

## Control Panel Function

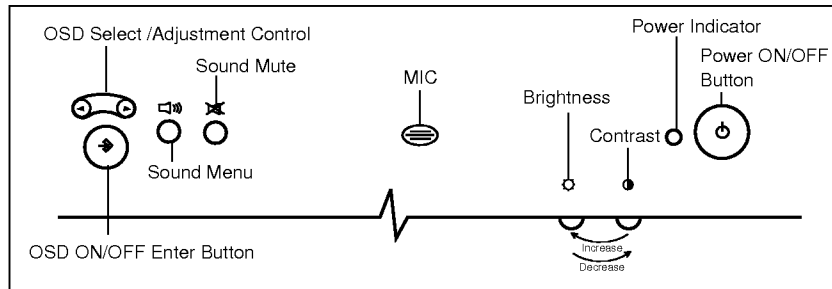



Buttons on the front of the monitor allow you to adjust the image easily through an OSD menu. As you choose controls, the selected icon shows you what the chosen control will do. These pictures give you immediate understanding of the controls. The following is a description of use for each button.

### Power ON/OFF Button

This button is used to turn the monitor ON and OFF. In case the monitor is in a stand-by mode, indicated by an amber color Power Indicator, push the Power Button again to return the monitor to its normal display operation.

### Power Indicator

This Indicator lights up green when the monitor operates normally. If the monitor is in DPM (Energy Saving) mode (stand-by/suspend/power off), this indicator color changes to amber.

-  **Contrast control**  
Adjust the display to the contrast desired. Move the thumbwheel located beneath this indicator to increase or decrease the display contrast.
-  **Brightness control**  
Used to adjust the brightness of the screen. Move the thumbwheel located beneath this indicator to increase or decrease the display brightness.
-  **OSD ON/OFF Enter button**  
Use this button to start/enter and exit from the On Screen Display (OSD). If there is no OSD on the screen, One press of this button will show the Main Menu.

◀▶ **OSD Select/Adjustment Control**

Use these buttons for selecting (highlighting) an OSD icon to be adjusted. It is also used for selecting the level of the selected item to be adjusted.

🔊 **Sound Menu:** To adjust sound menu.

🔇 **Sound Mute**

Used to select mute on (means sound off) and mute off (means sound on).



☰ **MIC :** Built-in microphone (Electret Condenser Microphone).

### On Screen Display (OSD) Control Adjustment

Making adjustments to the image size, position, and operating parameters of the monitor is quick and easy with the On Screen Display Control system, using only the ENTER button and Adjustment Control buttons. A quick example is given below to familiarize you with the use of the controls. Following this section is an outline of the available adjustments and selections you can make using the OSD.

Example;











Note : (Monitor and PC should be ON, with an image or prompt on the screen). A single press of the ENTER button will present you with the Main Menu as below, with the first item H-position(🖥️) highlighted.











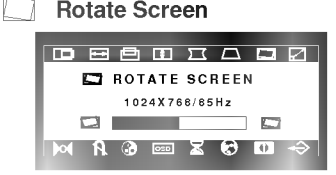
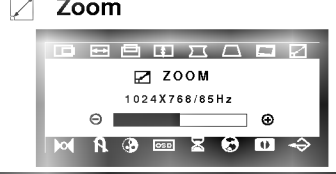

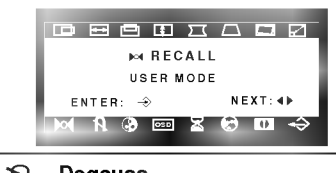
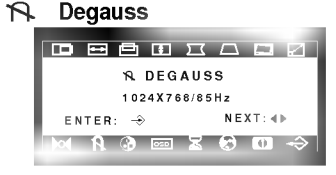
## On Screen Display(OSD) Selection and Adjustment

You were introduced to the procedure of selection and adjusting an item using the OSD system.

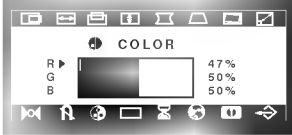
Listed below are the icons, icon names, and icon descriptions of the items that are shown on the Menu.

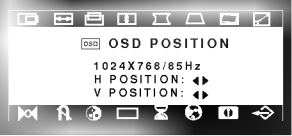
OSD Adjust	Description
 <b>Horizontal Position</b> 	To move picture image left and right. ◀ Moves the screen image left. ▶ Moves the screen image right.
 <b>Horizontal Size</b> 	To adjust image width. ◀ Decreases the size of the screen image. ▶ Increases the size of the screen image.
 <b>Vertical Position</b> 	To move image up and down. ◀ Moves the screen image down. ▶ Moves the screen image up.
 <b>Vertical Size</b> 	To adjust image height. ◀ Decreases the size of the screen image. ▶ Increases the size of the screen image.
 <b>Side Pincushion</b> 	To correct the bowing in and out of the image. ◀ Curves the image's edges inwards. ▶ Curves the image's edges outwards.

OSD Adjust	Description
 <p><b>Trapezoid</b></p> <p>TRAPEZOID 1024X768/85Hz</p>	<p>To correct geometric distortion.</p> <ul style="list-style-type: none"> <li>◀ Makes the screen image narrower at the top.</li> <li>▶ Moves the screen image wider at the top.</li> </ul>
 <p><b>Rotate Screen</b></p> <p>ROTATE SCREEN 1024X768/85Hz</p>	<p>To correct image rotation.</p> <ul style="list-style-type: none"> <li>◀ Tilts the screen image left.</li> <li>▶ Tilts the screen image right.</li> </ul>
 <p><b>Zoom</b></p> <p>ZOOM 1024X768/85Hz</p>	<p>To adjust Horizontal and Vertical image size simultaneously.</p> <ul style="list-style-type: none"> <li>◀ Smaller the image size.</li> <li>▶ Bigger the image size.</li> </ul>
 <p><b>Recall</b></p> <p>RECALL OK</p> <p>ENTER: → NEXT: ◀▶</p>  <p>RECALL USER MODE</p> <p>ENTER: → NEXT: ◀▶</p>	<p>If the monitor is operating in a factory preset mode, this control will reset the image to the factory preset mode.</p> <p>If the monitor is operating in a user mode, this control has no effect.</p>
 <p><b>Degauss</b></p> <p>DEGAUSS 1024X768/85Hz</p> <p>ENTER: → NEXT: ◀▶</p>	<p>Used to demagnetize the picture to give a more accurate image and color.</p>

OSD Adjust	Description
<p> <b>Color</b></p>  	<p>To select color temperature, 9300K/7200K/ user.</p> <ul style="list-style-type: none"> <li>◀ Decreases the amount of color in the image.</li> <li>▶ Increases the amount of color in the image.</li> </ul>
<p> <b>OSD Position</b></p> 	<p>To correct OSD image's Horizontal position and Vertical position.</p>
<p> <b>OSD Time</b></p> 	<p>To select OSD display time. (5~120 seconds)</p>
<p> <b>Language</b></p> 	<p>To choose the language in which the control names are displayed.</p>



OSD Adjust	Description
<p><b>Information</b></p> <p><b>INFORMATION</b> 1024X768/85Hz USER MODE: 5 PRESET MODE: 6</p> <p><b>PRESET MODE</b></p> <ol style="list-style-type: none"> <li>1 31.4kHz / 70Hz</li> <li>2 37.5kHz / 75Hz</li> <li>3 46.8kHz / 75Hz</li> <li>4 53.6kHz / 85Hz</li> <li>5 63.9kHz / 60Hz</li> <li>6 68.6kHz / 85Hz</li> </ol> <p>THE END</p> <p><b>USER MODE</b></p> <ol style="list-style-type: none"> <li>1 68.7kHz / 85Hz</li> <li>2 67.5kHz / 75Hz</li> <li>3 60.0kHz / 60Hz</li> <li>4 46.5kHz / 87Hz</li> <li>5 64.0kHz / 60Hz</li> </ol> <p>THE END</p>	<p>To inform users of preset and user mode data.</p>
<p><b>Exit</b></p> <p><b>EXIT</b> 1024X768/85Hz ENTER: &lt;=&gt;    NEXT: &lt;&gt;</p>	<p>To disappear of the OSD on the screen.</p>



## Sound Selection and Adjustment (🔊))

You were introduced to the procedure of selection and adjusting an item using the OSD system.

Listed below are the icons, icon names, and icon descriptions of the items that are shown on the main Menu.

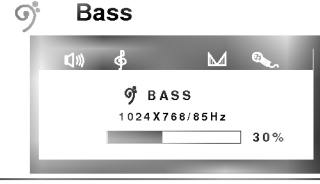
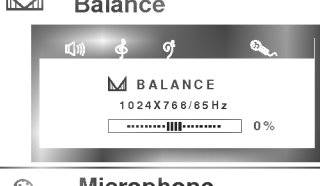
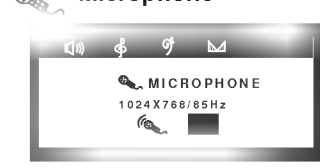
OSD Adjust	Description
 <p>🔊) <b>Volume</b></p> <p>🔊 VOLUME 1024 X 768 / 65 Hz 30%</p>	<p>Raises or lowers audio level.</p>
 <p>🎵 <b>Treble</b></p> <p>🎵 TREBLE 1024 X 768 / 65 Hz 30%</p>	<p>Raises or lowers treble level.</p>
 <p>🎵 <b>Bass</b></p> <p>🎵 BASS 1024 X 768 / 65 Hz 30%</p>	<p>Raises or lowers Bass level.</p>
 <p>📏 <b>Balance</b></p> <p>📏 BALANCE 1024 X 768 / 65 Hz 0%</p>	<p>Changes balance of left/right speaker level. (-50~50%)</p>
 <p>🎤 <b>Microphone</b></p> <p>🎤 MICROPHONE 1024 X 768 / 65 Hz</p>	<p>Enables or disables microphone usage.</p>

## Power Management System

This monitor incorporates new circuitry for lowering energy usage during idle time, following the Display Power Management Signalling (DPMS) guide lines of the Video Electronics Standards Association (VESA), and is certified as exceeding the EPA's Energy Star program for reduced power usage.

For the power savings feature to operate, the monitor must be used with either a PC having power saving circuitry. The monitor has three power-saving states, and the power saving operation is indicated by the power indicator on the front panel.

When the power indicator is green, operation is normal. When the power indicator is Amber, the monitor is in a power saving mode.

If the power indicator is Amber, press the power button to turn on the monitor. If the power indicator is Amber and you wish to use the PC again, move your mouse pointer or touch a keyboard button. When the monitor is not in use, save energy by turning it off.

### Power Consumption

MODE	H.sync	V.sync	Video	Power Consumption	LED Color
Normal	On	On	On	≤ 100W	Green
Stand-by	Off	On	Off	≤ 15W	Amber
Suspend	On	Off	Off	≤ 15W	Amber
Off	Off	Off	Off	≤ 8W	Amber

## Video Memory Modes

This multi-synchronous auto-scanning monitor can automatically detect and display several video modes falling within the monitor's scanning range of 30-70kHz Horizontal and 50-120Hz Vertical. In the PC area, this relates to a maximum flicker free usable resolution of 1280 x 1024 at a non-interlaced refresh rate of 60Hz Vertical.

For convenience, the monitor has a 37 mode memory, of which 6 modes come from the factory preset to popular video modes as described below.

Mode	Display Mode	Horizontal Frequency	Vertical Frequency	Polarity		Comments
				Horiz sync	Verti sync	
1	VGA2 720 x 400	31.47 kHz	70 Hz	-	+	Factory fixed, but may be updated by user's setting.
2	VGA VESA75 640 x 480	37.50 kHz	75 Hz	-	-	
3	SVGA VESA75 800 x 600	46.88 kHz	75 Hz	+	+	
4	SVGA VESA85 800 x 600	53.67 kHz	85 Hz	+	+	
5	VESA 1280 x 1024	63.98 kHz	60 Hz	+	+	
6	VESA85 1024 x 768	68.68 kHz	85 Hz	+	+	

Modes 13-37 are empty and can accept new video data.

If the monitor detects one of the above signals from your computer's video card, it will recall that mode and any stored image adjustments you may have made before. If the monitor detects a new video mode that had not been present before or is not one of the above listed factory presets, it will store a new mode automatically in one of the blank (empty) memory modes (in this example, mode 13). When you now adjust the OSD controls to your preference, these image settings will also be stored in mode 13. Whenever your video card or PC switches to the mode that the monitor recognizes as mode 13, your personal image settings will also be recalled.

**A note about the video memory modes:**

There is a total of 37 video memory modes, generally more modes than you will use at any one time. Of these 37 modes, 6 are permanent, factory fixed modes that cannot be changed, and another 6 are set at the factory, but may be overwritten to make more room. The remaining 25 modes are left blank (empty). If you use up the 25 blank modes and still have more new video modes, the monitor will store information in the other 6 soft preset modes for the new mode storage. If additional new modes are encountered, the monitor will delete the lowest memory mode and add the new mode.

If you use a video card that has a number of resolutions and frequencies that do not correspond to any of the monitor video modes set at the factory, here's what will happen:

- 1) As the monitor encounters new video data, if you adjust the image control icons, the monitor will save the new information in the next available empty mode (mode 13 if this is the first new data encountered).
- 2) If you have used up modes 13-37 with 25 new video modes, and the monitor encounters another mode (38th mode), it will store the new data in mode 13 and the old data of mode 13 is deleted.

In addition, If the monitor encounters 39th new video data, the old data of mode 14 is deleted and 39th data will replace the mode 14, with above method, when this monitor encounters new mode, it can update from mode 13 to mode 37 sequentially and continuously.

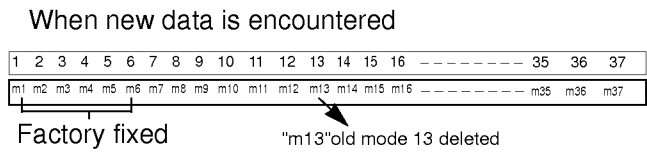
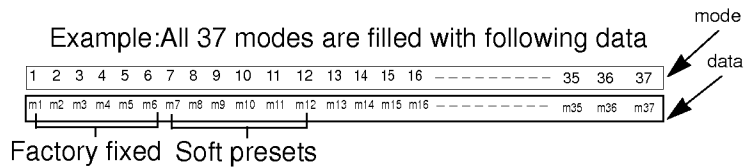

Because the monitor is designed this way, you will always have the most recent 31 video modes generated by your graphics card available with your own image settings recalled automatically.

## **Microphone Operation**

On the left side there is a MIC (Microphone) jack. By plugging a microphone in here, it may reduce the long length of cable needed to reach the PC's sound card. In order to use this MIC jack, you need to use the cable (supplied) to plug into the rear of the monitor (MIC OUT) and into the MIC input jack of your sound card (if available).

If you lost the supplied cable, consult with your dealer or buy a stereo cable.

## **Audio Features**

A major feature of this monitor is its built-in audio system. This conveniently integrates a stereo audio amplifier and speakers without taking up any more space. Because the monitor is designed like this, you can easily upgrade to audio capable multimedia applications by attaching your PC with sound card to the back of this monitor. It will result in significantly less cabling and space requirements.

## **Audio Connections**

Use the supplied cable to attach to the rear of the monitor (AUDIO IN) and to the sound card in your PC (line out). The cable will carry both left and right channel signals in one wire. Make sure when you use the PC to turn up the volume of the sound card all the way.

## Low Radiation Compliance (MPR II)

This monitor meets one of the strictest guidelines available today for low radiation emissions, offering the user extra shielding and an anti-static screen coating. These guidelines, set forth by a government agency in Sweden, limit the amount of emission allowed in the Extremely Low Frequency (ELF) and Very Low Frequency (VLF) electromagnetic range.

## Self Diagnostics

This monitor can sense when there is a possible problem present, and informs you of this condition by presenting you with a **SELF DIAGNOSTICS** OSD. This OSD may pop up when it is **On** but no signal is detected. In this case the message **NO SIGNAL DETECTED** will be high lighted, alerting you to check the signal cable connections.



## DDC (Display Data Channel)

DDC is a communication channel over which the monitor automatically informs the host system (PC) about its capabilities. This monitor has DDC function; DDC2B carry out uni-directional communication between the PC and the monitor. Under these situations, the PC sends display data to the monitor but not commands to control the monitor settings.

- NOTE :**
- PC must support DDC functions to do this.
  - Some older computer systems are not compatible with the DDC standard. If your monitor is displaying a monochrome image or the wrong resolution, need to change with a DDC compatible VGA card.

## Troubleshooting

**Symptom:** SELF DIAGNOSTICS message.

**Possible causes:**

- The signal cable is not connected.

**Symptom:** OUT OF FREQUENCY message appears.

**Possible causes:**

- The frequency of the sync input is outside the operating range of the monitor.

HORZ: 30kHz-70kHz  
VERT: 50Hz-120Hz



Use the graphics board's utility software to change the frequency setting(Refer to the manual for graphics board)

**Symptom:** The power LED is illuminated amber

**Possible causes:**

- Display power management mode.
- There is no sync signal.
- The signal cable is not fastened securely.
- Check the computer power and graphics adapter configuration. The signal cable is incorrectly configured or connected. Refer to Signal connector pin assignment on page 22 for reference.

**Symptom:** The image on the SCREEN is not centered, or too small, or not a rectangle shape.

**Possible Causes:** Image adjustment not been done yet in the current operating mode. Use the SELECT and ◀ or ▶ buttons to set the image to your liking.

**Symptom:** The monitor doesn't enter the power saving off mode (Amber LED).

**Possible Causes:** Computer video signal is not VESA DPMS standard. Either the PC or the video controller card is not using the VESA DPMS power management function.

## **Service**

1. Unplug the monitor from the wall outlet and refer servicing to qualified service personnel when :
  - The power cord or plug is damaged or frayed.
  - Liquid has been spilled into the monitor.
  - The monitor has been exposed to rain or water.
  - The monitor does not operate normally following the operating instructions. Adjust only those controls that are covered in the operating instructions. An improper adjustment of other controls may result in damage and often requires extensive work by a qualified technician to restore the monitor to normal operation.
  - The monitor has been dropped or the cabinet has been damaged.
  - The monitor exhibits a distinct change in performance.
  - Snapping or popping from the monitor is continuous or frequent while the monitor is operating. It is normal for some monitors to make occasional sounds when being turned on or off, or when changing video modes.
2. Do not attempt to service the monitor yourself, as opening or removing covers may expose you to dangerous voltage or other hazards. Refer all servicing to qualified service personnel.
3. When replacement parts are required, have the service technician verify in writing that the replacements used have the same safety characteristics as the original parts. Use of manufacturer specified replacements can prevent fire, shock, and other hazards.
4. Upon completion of any service or repairs to the monitor, ask the service technician to perform the safety check described in the manufacturer's service manual.
5. When a video monitor reaches the end of its useful life, improper disposal could result in a picture tube implosion. Ask a qualified service technician to dispose of the monitor.



## Specifications

### Sync Signal type

Type	H. sync	V. sync
Separate sync	H. sync	V. sync

### Signal Connector Pin Assignment

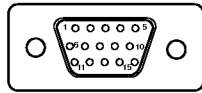

Pin	Separate Sync
1	Red
2	Green
3	Blue
4	Ground
5	Self-Test
6	Red Ground
7	Green Ground
8	Blue Ground
9	NC
10	Ground
11	Ground
12	SDA
13	Horiz.Sync
14	Vert.Sync
15	SCL

## Specifications

### Picture tube

15 inch (13.8 inches viewable) FST, Non-glare, 90 degree deflection, Darkface, 0.28 mm dot pitch

### Sync Input

Horizontal Freq. : 30kHz - 70kHz (Automatic)  
Vertical Freq. : 50Hz - 120Hz (Automatic)  
Input Form : Separate, TTL, positive/negative  
Signal input : 15 pin D-Sub connector

### Video Input

Display Area : 10.2 x 7.5 inch / 260 x 190mm (H x V)  
Input Form : Separate, RGB Analog, 0.7 Vp-p/75 ohm, positive  
Resolution : 1280 x 1024, 60Hz

### Audio

RMS Audio Output : 4 W (R+L)  
Input Sensitivity : 0.7 Vrms  
Built-in MIC : E.C.M type (Electret Condenser Microphone)  
Mic Jack :  $\varnothing$  3.5 Stereo

**Power Consumption:** 100 Watts max  
15 Watts suspend mode, stand-by mode  
8 Watts DPMS-Off mode

### Power input

100-240VAC 50/60Hz 1.5A

### Dimensions ( W x H x D )

16.4x12.9x15.4inch (417x 328 x 391 mm)

### Weight ( net )

14.9kg (32.8lbs)

Information in this document is subject to change without notice and does not represent a commitment on the part of LG Electronics Inc.

## Monitor Limited Warranty for the United States and Canada

LG Electronics U.S.A., Inc. will repair or at its option replace, without charge, your product which proves to be defective in material or workmanship under normal use, during the warranty period listed below from the date of original purchase. **This warranty is good only to the original purchaser of the product during the warranty period as long as it is in the U.S. including Alaska, Hawaii, U.S. Territories and all Canadian Provinces.**

### WARRANTY PERIOD

<u>MODEL #</u>	<u>LABOR</u>	<u>PARTS</u>	<u>HOW SERVICE IS HANDLED</u>
	3 YEARS	3 YEARS	Call 1-800-243-0000, 24 hrs a day, 7 days per week, please have your product type (Monitor, TV, VCR) and ZIP code ready.
		<u>CRT</u> 3 YEARS	

No other express warranty is applicable to this product. **THE DURATION OF ANY IMPLIED WARRANTIES, INCLUDING THE IMPLIED WARRANTY OF MERCHANTABILITY, IS LIMITED TO THE DURATION OF THE EXPRESS WARRANTY HEREIN. LG ELECTRONICS U.S.A., INC. SHALL NOT BE LIABLE FOR THE LOSS OF THE USE OF THE PRODUCT, INCONVENIENCE, LOSS OR ANY OTHER DAMAGES, DIRECT OR CONSEQUENTIAL, ARISING OUT OF THE USE OF, OR INABILITY TO USE, THIS PRODUCT OR FOR ANY BREACH OF ANY EXPRESS OR IMPLIED WARRANTY, INCLUDING THE IMPLIED WARRANTY OF MERCHANTABILITY APPLICABLE TO THIS PRODUCT.**

Some states do not allow the exclusion or limitation of incidental or consequential damages or limitations on how long an implied warranty lasts, so these limitations or exclusions may not apply to you. This warranty gives you specific legal rights and you may also have other rights which vary from state to state.

### THE ABOVE WARRANTY DOES NOT APPLY:

- To damages or problems which result from delivery or improper installation.
- To damages or problems which result from misuse, abuse, accident, alteration, or incorrect electrical current or voltage.
- To service calls, which do not involve defective workmanship or material, such as head cleaning and explaining the operation of the unit.

**Therefore these costs are paid by the consumer.**

### CUSTOMER ASSISTANCE NUMBERS:

<b>To Prove Warranty Coverage:</b>	→	<b>Retain your Sales Receipt to prove date of purchase.</b>
	→	Copy of your Sales Receipt must be submitted at the time warranty service is provided.
<b>To Obtain Product or Customer Assistance:</b>	→	Call 1-800-243-0000 (Mon-Fri 8am-5pm CST) Push Appropriate Menu Code.
<b>For Your Nearest Authorized Service Center:</b>	→	Call 1-800-243-0000, 24 hrs a day, 7 days per week, please have your product type (Monitor, TV, VCR) and ZIP code ready.
	→	Or see website at <a href="http://www.LGService.com">http://www.LGService.com</a> or send e-mail to <a href="mailto:techsupport@LGService.com">techsupport@LGService.com</a>
<b>All Customers In Canada Please Call</b>	→	(905)-670-0650