



**Hi-Fi
Video Cassette Recorder
Owner's Manual**

MODEL: W90Y



Before connecting, operating or adjusting
this product, please read this instruction booklet
carefully and completely.



Feature & Contents

Features

- HQ (High Quality) picture enhancement system that improves picture sharpness and detail
- Centre tape mechanism for high quality pictures
- Full function infra-red remote control handset
- Programmable 80 channel memory with Frequency synthesised tuner
- ACMS (Automatic Channel Memory System) - the channels will be preset and memorized automatically.
- 6 event/1 month programmable timer
- Recording and playback for 16:9 Wide-screen format
- Energy Saving function
- LP - Long Play - recording and playback
- Shuttle Controls
- Logic & Jet Search
- VISS - VHS Index Search System
- Child Lock
- Auto Head Cleaner
- Auto Power on and Play
- Self diagnosis function
- Fine still, Frame advance & Variable Slow functions
- Real Time Counter
- Quick Start function
- Digital Auto Tracking System
- Hi-Fi system for reception of Stereo, Bilingual & Mono sound
- Hi-Fi Audio System & Level Meter
- Simulcast Recording

Contents

Reference Pages

INTRODUCTION	2~5
Operating the video recorder	3-5
• The remote control handset	3-4
• The front & back of the video recorder	5
PREPARATION	6~14
Installing your video recorder	6
Setting the VCR output channel	7
On screen displays	8
• The main menu	8
• The Set-up menu	8
Storing TV stations	9-13
• Automatic tuning	9
• Manual tuning	10-11
• Moving the programme order of the "TV station table" menu	12
• Clearing stations from the "TV station table" menu	13
• Fine tuning	13
Time and date setting	14
Using the VCR to play back a tape	15~18
Using the VCR to play back a tape	15-16
• Loading & Unloading a video cassette	15
• Types of video cassette	15
• How to using the Energy saving mode	15
• Normal playback	16
• Picture sharpness adjustment	16
• Still picture playback	16
Other playback features	17-18
• Fast forward, Rewind	17
• Logic, picture, Jet search	17
• How to using the Shuttle Ring	18
• Slow motion playback, Shuttle	18
RECORDING	19~23
Using the video recorder to record	19-20
• To record	19-20
• Immediate timer (QSR)	20
• Selection of the colour system	20
Programming the video recorder timer	21-23
• Recorder timer programming using the on screen displays	21-22
• Checking & clearing stored timer programmes	23
• Overlapping timer programmes	23
ADDITIONAL INFORMATION	24~33
Other features	24-28
• The child lock, 16:9 Compatibility, Self-Diagnosis	27
• The VHS index search system (VISS)	28
Connection to other equipment	29
The Hi-Fi stereo sound system	30
Recording from another equipment	31
Specifications	32
Before calling for service . . .	33

Operating the video recorder

The Remote Control Handset

This video recorder is designed so that almost all of its functions can be controlled from the REMOTE CONTROL HANDSET. This must have a "line of sight" to the sensor on the front of the video recorder. It must be within an angle of 30 degrees either side of the centre. The maximum operating distance is about 7.5m (25 feet).

Some functions can also be controlled with the controls on the FRONT PANEL of the video recorder.

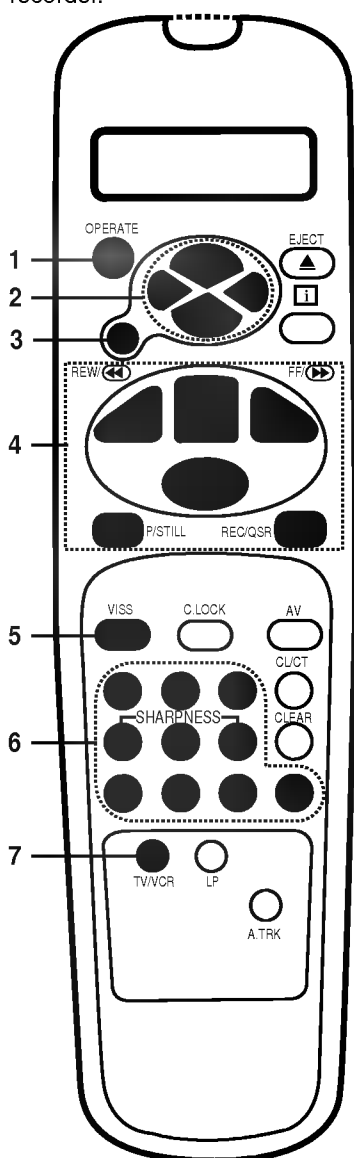

1 OPERATE

To switch the video recorder on and off.

2 CURSORS (^ v < >)

- ^v:
 - During OSD menu, for moving the cursor, selection bar up or down.
 - Switches one channel programme up or down.
 - During still playback, adjusting vertical tremble.
- <>:
 - During OSD menu, for moving the cursor to the left or right.
 - Adjust the playback speed (see p 18).

The cursor "<" button can be used to clear a data.

3 OK

- Confirms menu selection (see p 8).
- Calls the on screen display (see p 25).

4 Basic operation buttons;

- PLAY (see p 16).
- STOP (see p 16).
- REWIND/REVIEW (see p 17).
- FAST FORWARD/CUE (see p 17).
- P/STILL (see p 16, 19).
- REC/QSR (see p 19 to 20).

5 VISS

To activate the VISS (VHS INDEX SEARCH SYSTEM) (see p 28).

6 NUMBER BUTTONS:

To select programme channels. To programme numeric information into On screen displays.

NOTE: The "4", "5" and "6" buttons can be used to control the picture sharpness during playing back (see p 16).

7 TV/VCR

Set this button to;

- **VCR:** To monitor, view playback or view the video recorder's tuner.
- **TV:** To watch TV or view another programme while recording one programme.

Operating the video recorder

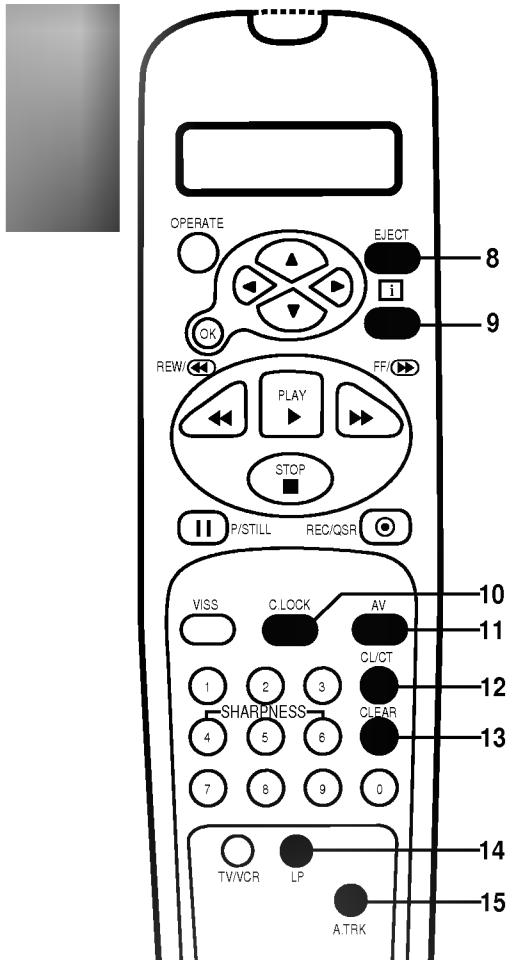

- 8** **EJECT**
To eject a tape (see p 15).
- 9** **i**
To display the on screen display (OSD) menu (see p 8).
- 10** **CHILD LOCK**
To turn the CHILD LOCK function on/off (see p 27).
- 11** **AUDIO/VIDEO MODE**
To select the input source of a recording (see p 19).
- 12** **CLOCK/TAPE COUNTER**
To switch the display on the front panel of the video recorder between the current time and the tape counter (in hours and minutes) (see p 25). This function will only operate when a tape is loaded.
- 13** **CLEAR**
To reset the tape counter to zero (see p 25).
- 14** **TAPE SPEED SELECT (LP)**
To select the recording speed of the tape (see p 19).
- 15** **AUTOMATIC TRACKING**
To select automatic adjustment of the tracking (see p 26).

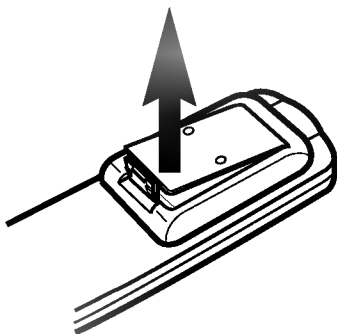

How to install batteries

The wireless remote control is powered by two "AAA" size batteries.

- 1** Remove the battery compartment lid.
(Lift it up while pressing the tap forward.)
- 2** Load the new batteries with their polarities (⊕ and ⊖) aligned properly and replace the lid.

If you do not intend to use the remote control unit for a long period of time, remove the batteries and store them in a cool, dry place.

Operating the video recorder

The front of the Video Recorder

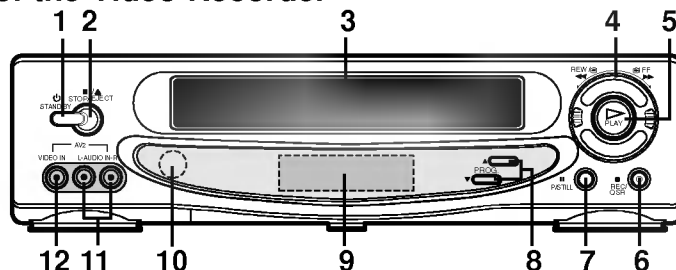

- | | |
|--|--|
| <p>1 STAND BY
To switch the video recorder on and off. (see p.15).</p> <p>2 STOP/EJECT
To stop the tape, or eject it from the video recorder (see p 15).</p> <p>3 VIDEO CASSETTE COMPARTMENT
When a cassette is inserted loading is completed automatically.</p> <p>4 SHUTTLE RING
Turn to start rewind or fast forward in the stop mode (see p 18).</p> <p>5 PLAY
To play the tape (see p 16).</p> <p>6 REC/QSR
Used to record and set the QSR (Quick Set Recording) time (see p 19 to 20).</p> | <p>7 P/STILL
Switches to still picture (see p 16), during recording to pause (see p 19).</p> <p>8 PROG. (▼/▲)
Allows you to scan through memorized channels.</p> <p>9 MULTI FUNCTION DISPLAY
Display of time, tape counter, Audio level meter or other information about the status of the video recorder.</p> <p>10 REMOTE CONTROL SENSOR
To receive the signals from the remote control handset.</p> <p>11 AUDIO INPUT TERMINALS
To record audio from an external audio source (see p 29).</p> <p>12 VIDEO INPUT TERMINALS
To receive a signal from another video equipment (e.g. Camcorder) (see p 29).</p> |
|--|--|

The back of the Video Recorder

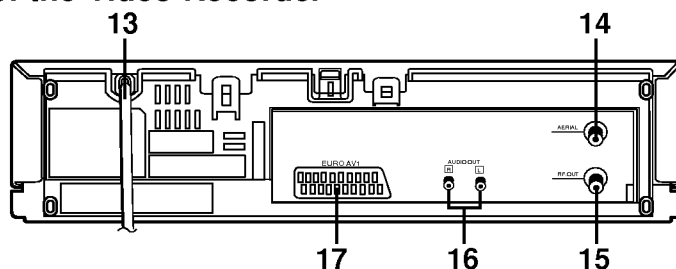

- | | |
|---|--|
| <p>13 MAINS LEAD</p> <p>14 AERIAL INPUT
Connect the external aerial to this terminal.</p> <p>15 RF. OUT
Connect this terminal to the AERIAL terminal on the back of the TV, using the coaxial RF cable (supplied).</p> | <p>16 AUDIO OUT TERMINALS (R/L)
Connect your Hi-Fi system to play the video recorder sound (see p 29).</p> <p>17 EURO AV1
To connect the video recorder to your TV set or to another video recorder (see p 31).
For recording from EURO AV1 select "A1 (AV1)" with the "AV" button (see p 19).</p> |
|---|--|

Installing your video recorder

IMPORTANT!

Before you use your video recorder you must:

- 1 Connect the video recorder to your TV aerial and TV set. (described later on this page).
- 2 Set the tuner channels so that the video recorder can receive TV signals (see p 9 to 11).
When this has been done, the setting up of the video recorder is complete.

PREPARATION

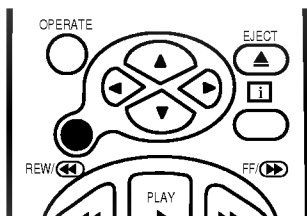
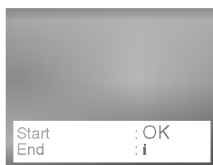
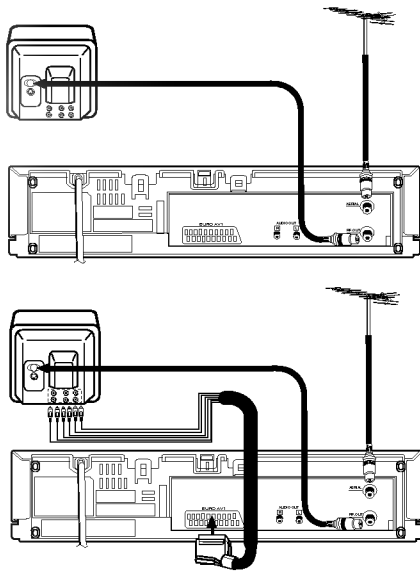

6

Connecting the video recorder to your TV

AERIAL/RF CONNECTION

For TV sets without AV input terminals:

- 1 Disconnect the aerial from your TV set and plug it into the socket marked "AERIAL" at the back of the video recorder.
- 2 Use the coaxial cable supplied to connect the aerial terminal on your TV set to the socket marked "RF.OUT" at the back of the video recorder.
- 3 Plug the video recorder into a mains wall socket.

A/V CONNECTION

This video recorder and your TV set can also be connected with a EURO SCART cable (Scart to RCA). This connection ensures the highest picture/sound quality.

Initial preset

For the following steps we do assume that you have just connected your video recorder for the very first time. In this case the video recorder is on after mains connection. You should not touch any buttons yet. On the connected TV you will now see.

NOTE: If this menu does not appear, your video recorder was programmed already.

- 1 Press the "OK" button.
- 2 Wait some minutes, until all stations are searched, sorted and the first one is shown on the screen.
You might want to make manual changes to the automatically set stations, e.g. change the order or delete double received stations. This is described in full detail from pages 12 to 13.

Setting the VCR output channel

Your TV set receives the video recorder signal like another TV station. So you have to select a programme number for the video recorder.

Take care to select this programme number, whenever you control the video recorder, or watch a recording. Only if you have selected this programme number, which we call video programme number, you will see the picture from the video recorder on the screen.

If you connect a monitor or a TV set equipped with EURO SCART socket or audio and video terminals, this adjustment will not be necessary. Consult the operating instructions of your TV set. Connect the video recorder as described in the section on Connections (see on previous page).

Setting the output channel of the VCR

A SETTING THE VIDEO CHANNEL WITH PLAYBACK

The output channel of the video recorder is set at UHF channel 36.

- 1 Turn on the TV set and the video recorder.
- 2 Play any video cassette tape on your video recorder.
- 3 Select the correct channel (36) on your TV set. And then you will see the picture being played in video recorder.
(Note - You will need to look at the instruction manual for your TV set if you do not know how to do this.)

B SETTING THE VIDEO CHANNEL WITH OSD (ON SCREEN DISPLAY)

- 1 Turn on the TV set and the video recorder.
- 2 Repeat above No. 3. And then you will see a blue background picture on the TV screen.
- 3 Store this channel in an unused programme number on your TV set.

Changing the transmitter channel

If the channel 36 is already occupied at your TV set, or if the picture is distorted, you can change the transmitter channel of the video recorder.

- 1 Select an unoccupied channel between 22 and 68 on your TV set.
- 2 During power off mode (only clock display) hold down the PROG. "▼" and "▲" buttons on the VCR for more than 4 seconds. Then, "RF-CH 36" will be displayed on the VCR's display.
- 3 Press the PROG. "▼" or "▲" buttons on the VCR to select another video channel e.g. between channels 22 and 68.
- 4 Press the "STAND BY" button when you have finished.

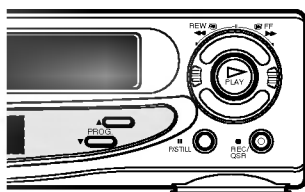

On Screen Displays

PREPARATION

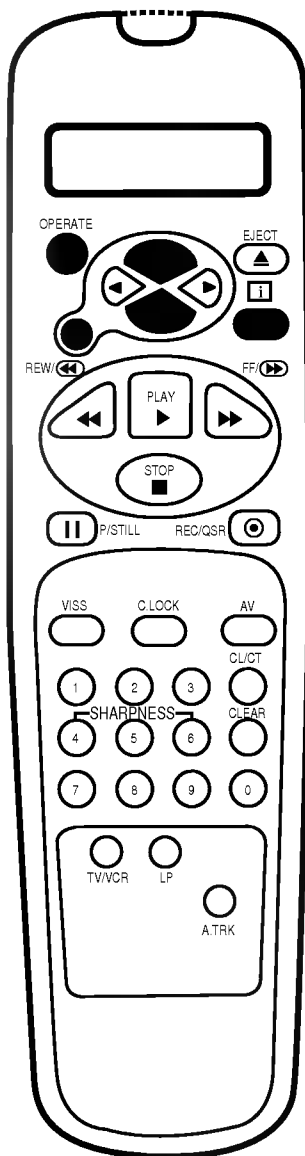

A number of the features of this video recorder can be set and altered using the handset with On Screen Displays (menus) on the TV screen.

The Main menu

- 1** Switch on your TV set and video recorder by pressing the "OPERATE" button.
- 2** Press the "i" button to display the Main menu.
- 3** Press the cursor "∧" and "∨" buttons to select the desired menu and press the "OK" button.

NOTE - After using the menus press the "i" button to remove menus from the TV screen.

TIMER PROGRAM

Used to record a programme with the timer (see p 21 to 22).

TV STATION TABLE

Used to view stored TV stations or to set TV station information manually (see p 10 to 11).

ACMS

Used for automatic setting of the TV stations (see p 9).

CLOCK SET

To set the clock manually (see p 14).

The Set-up menu

SYSTEM (AUTO, PAL and MESECAM)

Select the colour system used for playback and recording (see p 20).

RF AUDIO (D/K and B/G)

Select the channel of audio output according to your TV type.

"D/K": for PAL D/K TV.

"B/G": for PAL B/G TV.

16:9

To select the aspect ratio of your TV.

AUTO: for playing back wide-screen programmes as wide, normal programmes as normal (see p 27).

ON: for recording and playback with a 16:9 Wide-screen format recording.

OFF for recording and playback with a normal format.

NOTE:

This function works only when this VCR is connected to a TV with EURO SCART cable (SCART to SCART).

OSD (On Screen Display)

Switches the on screen display OFF or ON (see p 25).

AUDIO (STEREO, L-CH, R-CH or MONO)

Used to select the channel for audio output (see p 30).

AUDIO MIX ON or OFF

Used to select audio outputs during playback (Hi-Fi and/or NORMAL) (see p 30).

LANGUAGE

Allows you to select the language of the On Screen Display. You can select among English, Russian and Deutsch.

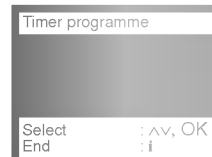

Storing TV stations

Up to 80 TV stations (80 channels) can be stored in the memory of this video recorder. These can be set automatically or manually.

Automatic tuning

To carry out Automatic tuning:

- 1** Turn on the TV and the video recorder (with the "OPERATE" button).
- 2** Press the "i" button and select "ACMS" by using the cursor "▲" and "▼" buttons.
- 3** Press the "OK" button.
- 4** Press the "OK" button to start the automatic storing of the channels of the TV stations in your area.
- 5** Automatic channel tuning has been completed when the "TV station table" menu appears on the TV screen.
- 6** Press the "i" button to remove the menus from the TV screen.

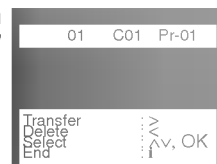
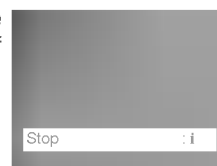
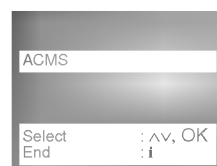
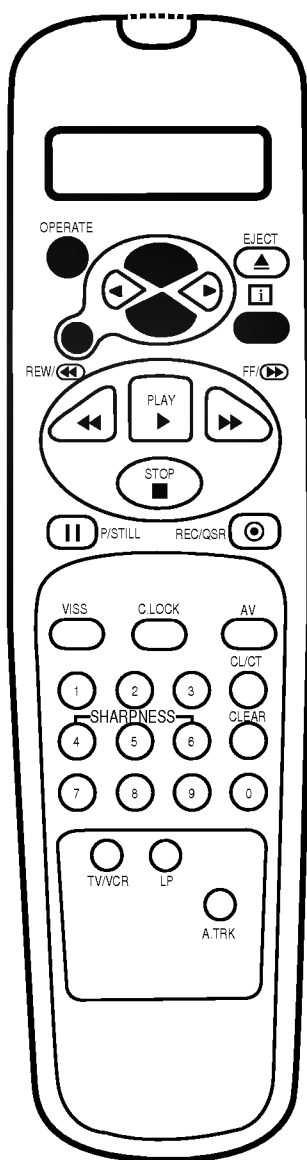

PREPARATION

Storing TV stations

PREPARATION

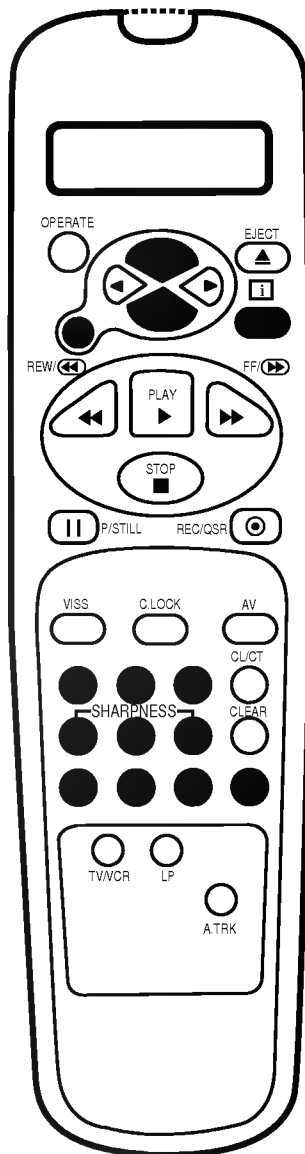

Manual tuning

TV station Channel numbers and Station names can be stored manually.

- 1** Press the "i" button on the video recorder handset. The menu will appear on the TV screen.
- 2** Use the cursor "∧" or "∨" buttons to select "TV station table" and press the "OK" button.
- 3** Use the cursor "∧" and "∨" buttons to select the Programme number (Pr) where you wish to store a channel or add or correct a name. If you have reached the fifth line, another depressing of "∨" button switches to the next five stations.
- 4** Press the "OK" button. The programme, channel and station information stored in the video recorder will be displayed over the picture being transmitted by that channel, or a blue background if the channel is not set.
- 5** Select the reception your first station with number button "1" or "2".
"1" for standard channels C01-78 or "2" for special channels (cable) S01-S41 and enter the channel number of your first station with number buttons. The TV picture appears in the background.
- 6** Press the cursor "OK" button to set the station name manually.
- 7** Enter the first letter of the station name by repeatedly pressing the cursor "∧" and "∨" buttons.

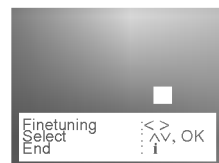
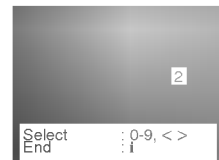
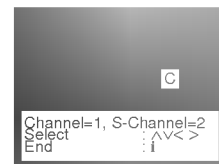
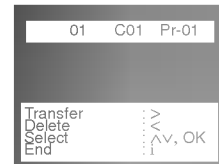

Storing TV stations

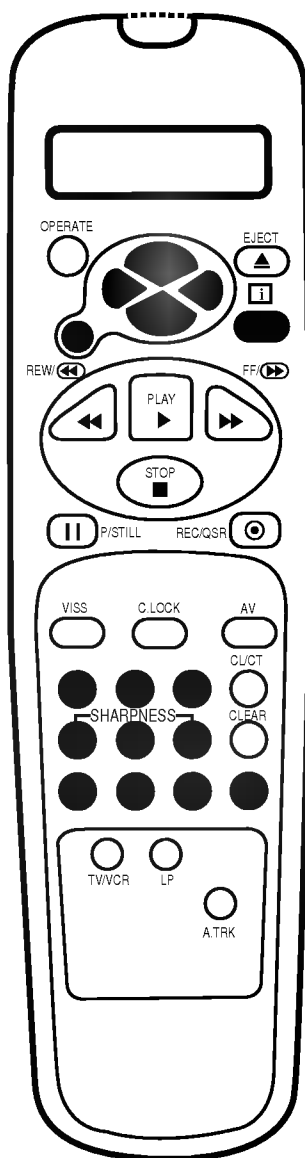

8 Move the square to the next position with the ">" button and write in the next letter of the stationname. For corrections move back with the "<" button.



9 When you have the station name as required press the "OK" button. The "TV station table" menu will be displayed.

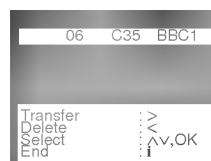

10 Store other stations, missing or incorrect station names using steps 3 to 9.

11 End the station storing by pressing the "i" button.

Selecting stored TV stations

Stored TV stations can be selected in either of two ways.

1 Use the "∧" and "∨" buttons to move from one station to another.

2 Enter the programme number with the number buttons, to select a station directly. You can enter the stations 1 to 9 with the one digit only. The channel will be selected at once.

When the channel is changed, a screen display (of a seconds duration) gives the programme number, and if the broadcast is STEREO or BIL (Bilingual).

If you are not satisfied with the quality of any of the TV pictures being received it may be because the video recorder output channel and one or more of the receiving channels are interfering with each other. Set the video recorder to a different output channel (see the section "Setting the VCR output channel" p 7).

Storing TV stations

PREPARATION

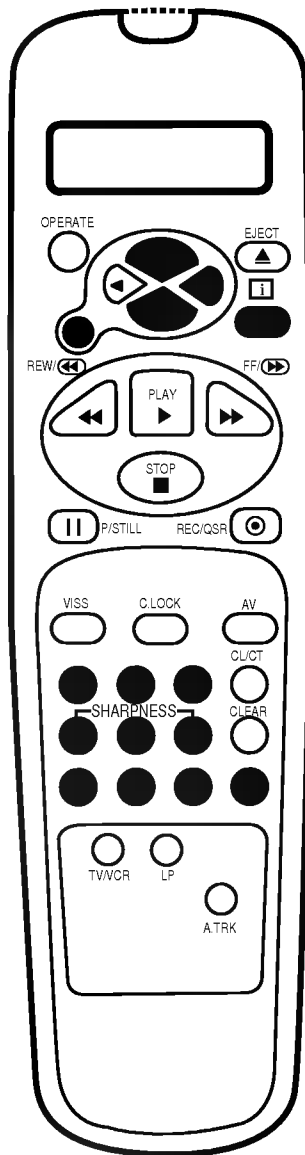

Moving the programme order of the "TV station table" menu

If you want to move the order of the TV stations you can easily do so as follows:

- 1** Press the "i" button on the remote control handset. The menu will appear on the TV screen.
- 2** Select "TV station table" with the cursor "▲" and "▼" buttons and press the "OK" button.
- 3** Move the cursor down or up with the cursor "▲" and "▼" buttons to select the programme that you want to transfer to another position in the menu (for example "Pr No. 03").
- 4** Press the cursor "➤" button to select transfer.
- 5** Use the number buttons to enter the programme number to which you wish to transfer the selected programme (for example Pr No. 04").
- 6** Press the "OK" button. The selected station will be moved to the new programme number.
- 7** Move other stations, if you wish, by repeating steps 3 to 6.
- 8** Press the "i" button to remove the menus from the TV screen.

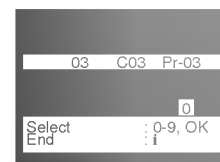
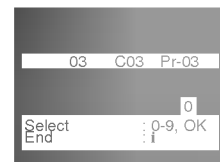
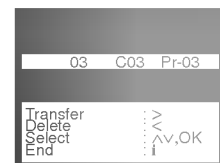
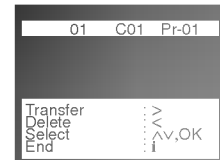

Storing TV stations

Clearing stations from the "TV station table" menu

If you want to clear a TV station from the video recorder's store you can easily do so as follows:

- 1** Press the "i" button on the remote control handset. The Main menu will appear on the TV screen.
- 2** Select "TV station table" and press the "OK" button to select.
- 3** Move the cursor up or down with the cursor "▲" or "▼" button to select the programme that you want to clear. (for example station "Pr - 03")
- 4** Press the "<" button to delete. After a short while, the selected station will be cleared.
- 5** Clear other stations, if you wish, by repeating steps 3 and 4.
- 6** Press the "i" button to remove the menus from the TV screen.

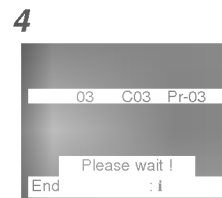
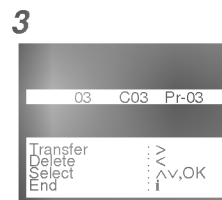

PREPARATION

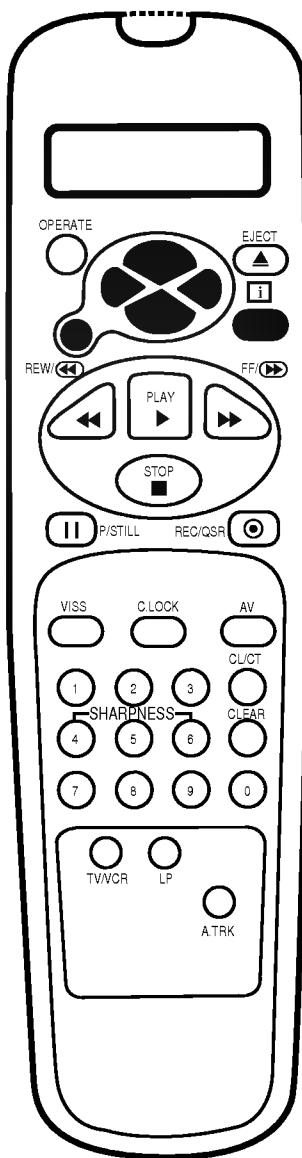

Fine tuning

If the picture quality is poor, because TV reception is weak, it might be improved by manually tuning the video recorder as follows:

- 1** Press the "i" button on the remote control handset. The Main menu will appear on the TV screen.
- 2** Select "TV station table" and press the "OK" button to select.
- 3** Move the cursor up or down with the cursor "▲" or "▼" button to select the programme that you want to fine tune.
- 4** Press the "OK" button. The channel and station setting screen will be displayed.
- 5** Move the symbol hand down with the "▼" button to select "Station".
- 6** Adjust for the best quality picture and sound with the cursor "<" and ">" buttons.
- 7** Press the "i" button twice to remove the menus from the TV screen.

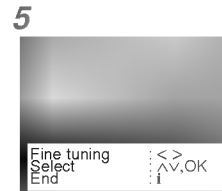
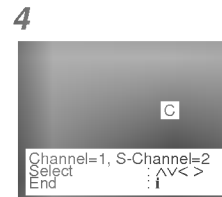
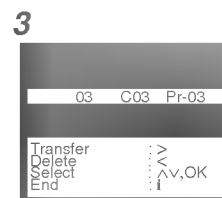

Time and date setting

PREPARATION

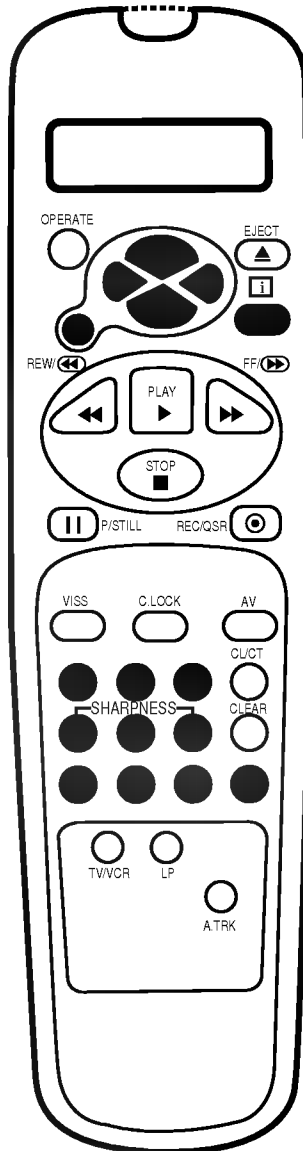

Setting the video recorder's clock

To manually alter the clock:

- 1 Press the "i" button. The Main menu appears on the TV screen.
- 2 Select "Clock set" with the cursor \wedge and \vee buttons.
- 3 Press the "OK" button.
- 4 Use the number buttons to enter or alter the Hours, Minutes, Day, Month and Year (using the 24 hour clock).
The day of the week will appear automatically when you have entered the date.
NOTE: Enter 1 as 01, 2 as 02 etc.
 - Correct errors during inputting with cursor $<$ and $>$ buttons.
- 5 Press the "i" button to remove the menus from the TV screen.
The set time will appear on the video recorder's Display.

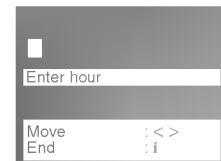
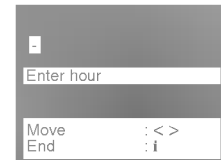
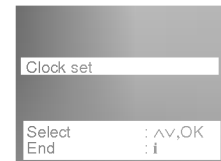

Using the VCR to play back a tape

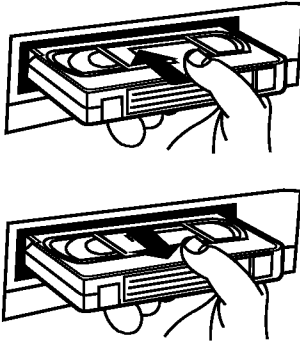

NOTE - Loading and unloading of a video cassette is only possible when the video recorder is plugged into a power source.

Loading & Unloading a video cassette

- 1** Insert the cassette into the video recorder with the window side up and the arrow pointing away from you. Do not attempt to insert a cassette which is upside down or back to front.
Gently press the middle of the tape.
- 2** Press the "EJECT" button, on either the handset or the front panel of the video recorder.
The cassette compartment will open and the video cassette will be partially ejected.
"EJECT" will appear for a few seconds on the TV screen.
It is not necessary to switch on the video recorder, by pressing the "OPERATE" button before ejecting a video cassette.

Note - It is advisable to remove a video cassette from the video recorder when not in use. Rewind and unload it.

Types of video cassette

Use VHS tapes in this video recorder.

On SP (standard play) the maximum record and playback time is that given on the video cassette.

For example E-180 will record/play back for 180 minutes.

For example T-120 will play back for 120 minutes.

On LP (long play) the maximum record and playback time is twice that given on the video cassette.

For example E-180 will record/play back for 360 minutes.

For example T-120 will play back for 240 minutes.



Accidental erasure prevention - If you do not wish to record on a tape, and hence erase what is already recorded on it, then remove the safety tab on the back edge of the video cassette.



Cover the hole with cellophane tape - It is possible to record on a video cassette from which the safety tab has been removed by covering the hole with cellophane tape.

Refer to the instructions included with the video cassette for more information.

How to using the Energy saving mode

- 1** Press the "STAND BY" button on the VCR. The clock and channel number will be displayed on the video recorder's display.
- 2** Press the "STAND BY" button on the VCR once again. "SLEEP" indicator appears on the video recorder's display. If you press the "STAND BY" button once again within 10 seconds, video recorder will be the energy saving mode. The STAND BY LED will light.
Otherwise, if you do not press the "STAND BY" within 10 seconds, video recorder will be the operate off mode.
For releasing the energy saving mode, press the "STAND BY" button once again.

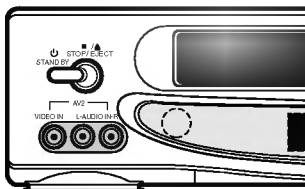

Using the VCR to play back a tape

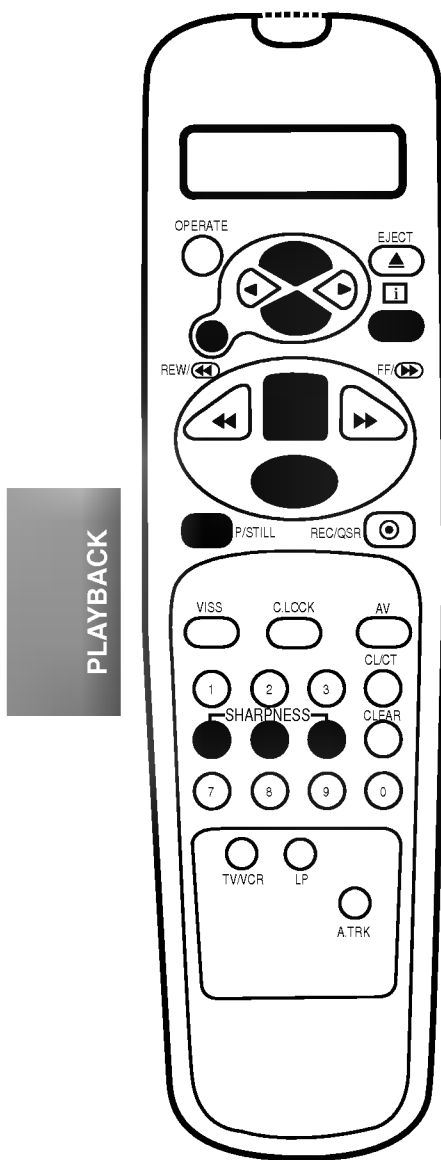

Normal playback

- 1 Press the "PLAY" button to start playing a tape (called Normal playback). "PLAY" will appear for a few seconds on the TV screen.

Automatic tracking - The video recorder will automatically adjust the tracking to give the best quality picture. A.TRK will appear on the video recorder's display while it is doing this.

Standard Play (SP) or Long Play (LP) tape -

The video recorder will automatically recognise whether the tape has been recorded at normal speed (SP) or half-speed (Long Play - LP), and play it back at the correct speed. If it is a long play tape LP will be shown on the video recorder's display.

Automatic playback - If the video cassette has had its safety tab removed, so that it cannot be erased, then the video recorder will automatically start playing the tape.

- 2 Short interruptions of the playback up to 5 minutes can be made with the "P/STILL" button. Continue playback by pressing the "PLAY" button.
- 3 End the playback with "STOP" button.
 - If the end of the tape is reached, the video recorder stops automatically, rewinds, stops, ejects the tape and switched off.

Picture sharpness adjustment

During playback you can adjust the "sharpness" of the picture by pressing the number 4 and 6 buttons. You can also return to the initial position by pressing the number 5 button.

Still picture playback

You can playback and advance a still picture as follows:

- 1 Press the "P/STILL" button during playing back. You see a still picture on the TV screen.
- 2 You can remove the vertical tremble with the cursor "∧" and "∨" buttons.
- 3 You can advance the still picture by pressing the "P/STILL" button. By repeatedly pressing this button the picture advances one frame at a time.
- 4 To switch off the still picture, press the "PLAY", or the "STOP" buttons.

Other playback features

This video recorder will allow you to rapidly wind a tape forwards or backwards, search a cassette tape, view individual frames on a tape, and play back a tape in slow motion.

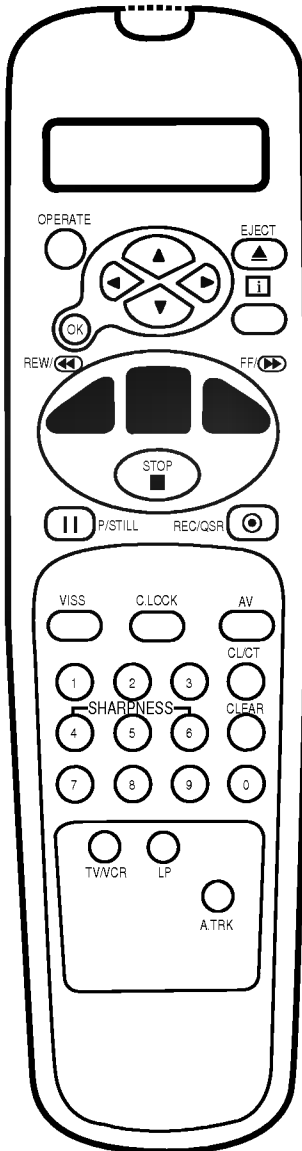

Fast forward (FF)

Pressing the fast forward (" FF ") button with the tape on stop, will rapidly wind the tape forward. "FF" will appear for a few seconds on the TV screen.

Rewind (REW)

Pressing the rewind (" REW ") button with the tape on stop, will rapidly wind the tape backwards. " REW " will appear for a few seconds on the TV screen.

LOGIC search

If you hold down either of the search buttons (" REW " or " FF ") during fast forwarding or rewinding the tape, the picture will be seen at about 7 times (NTSC recorded tape: 5 times) the normal playback speed. This enables you to see where you are on the tape. When you release the button the video recorder continues fast forward or rewind.

Picture search - CUE & REVIEW

You can also quickly carry out a visual search for a desired section on a tape using the CUE and REVIEW functions.

During playing back press either the fast forward (" FF ") or rewind (" REW ") button.

The tape will be played forward or backwards at about 7 times (NTSC recorded tape: 5 times) the normal playback speed. When the desired point on the tape has been reached press the " PLAY " button and the video recorder will continue to play back the tape at the normal speed.

Picture search will only continue for about 3 minutes, after which the video recorder will return to normal playback mode.

JET search

If during picture search you hold down either of the search buttons (" REW " or " FF ") for more than 1 second the picture will be played at about 11 times (NTSC recorded tape: 9 times) the normal playback speed. When the desired point on the tape has been reached, release the search button and the video recorder will continue to playback the tape at the normal speed.

NOTE - During a visual search, jet search or still playback, the sound is muted and there will be some "noise streaks" on the TV screen.

Other playback features

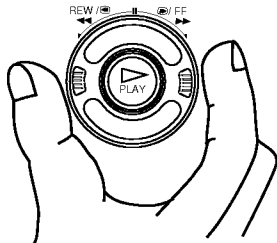

How to using the Shuttle Ring

The playback speed can be adjusted step by step in both forward or reverse direction by using the SHUTTLE RING.

- 1 Rotate the SHUTTLE RING while the video recorder in the playback or still playback mode to select the desired playback speed and direction.

You can reach the following playback speeds:

PLAYBACK: fast review, review, -3X play, -play, 2X play, cue, fast cue.

STILL PLAYBACK: fast review, review, -3X play, -play, -1/19 slow, still, 1/19 slow, play, 2X play, cue, fast cue.

- 2 Release the SHUTTLE RING to switch the playback or still playback mode.

Slow motion playback, Shuttle

This video recorder is equipped with a slow motion and shuttle features.

- 1 During playing back or still picture press the cursor "<" or ">" button.
- 2 You can reach the following playback speeds: fast review, review, -3X play, -play, -1/6 slow, -1/19 slow, -1/32 slow, still, 1/32 slow, 1/19 slow, 1/6 slow, play, 2X play, cue, fast cue.
- 3 If distortions can be seen in the picture, remove them with the cursor "^" and "v" buttons.
- 4 To switch off the slow motion, press the desired function, e.g. playback, search, still picture or stop.

The slow motion playback will only continue for about 3 minutes, after which the video recorder will return to normal playback mode, to avoid damage of the tape.

When using the special playback effects (logic, picture and jet search, still and slow motion playback) with a tape recorded in LP, there will be a loss of colour and there may be noise bars on the picture.

NOTE:

During Slow or Still playback, the noise bars can be appeared on the picture according to status of tape (especially NTSC recorded tape). In these cases adjust the tracking to playback a tape with the optimum picture quality. You can adjust the tracking with the cursor "^" and "v" buttons.

PLAYBACK

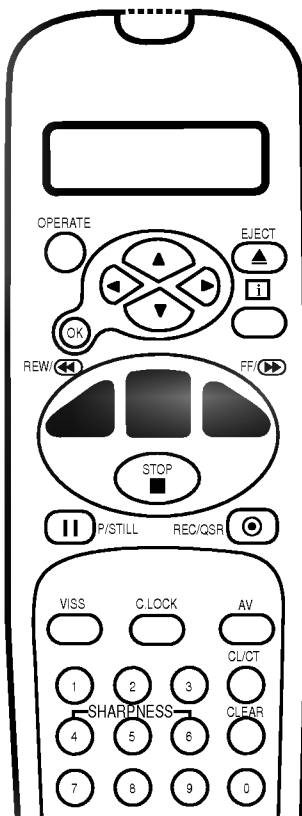

Using the video recorder to record

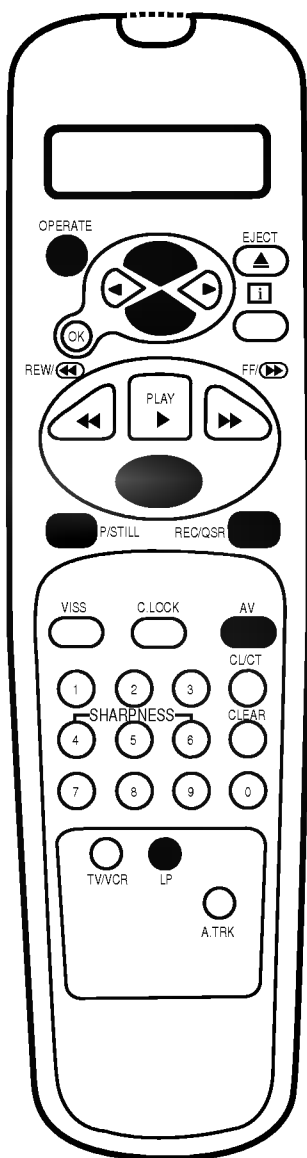

Introduction to the recording features

There are a variety of recording modes available to you on this video recorder.

- 1 You may record immediately (a programme you may be watching).
- 2 You may record immediately for a set period of time of up to 9 hours. This is called Quick Set Recording (QSR).
- 3 You may record at a later time (up to 1 month from the present) using the built-in timer. Up to 6 of these automatic recordings may be set at the same time -provided, of course, that there is sufficient time on the video cassette.

Note - Ensure that the safety tab has not been removed from the video cassette on which you wish to record.

To record

- 1 Switch on the TV set and video recorder.
- 2 Insert a video cassette with the window side up, and the arrow pointing away from you, or if a video cassette is already loaded switch on the video recorder by pressing the "OPERATE" button.
- 3 Select the programme channel with the number buttons or cursor "▲" and "▼" buttons.

NOTE:

If you want to record from one of the EURO SCART socket on the back of the video recorder, or from the AUDIO/VIDEO input terminals on the front, press the "AV" button to the correct position, as shown by the display on the TV screen.

"SC": for Hi-Fi audio recording from AUDIO IN (L/R) (11) terminals of your audio system.

"AV1": for recording from EURO AV1 scart socket.

"AV2": for recording from VIDEO IN (12) and AUDIO IN (L/R) (11) terminals.

- 4 Select LP with the "LP" button, if you want to record in long play mode.
- 5 Press the "REC/QSR" button to start recording. "RECORD" will appear for a few seconds on the TV screen. "MARK" will appear on the video recorder's display.

The recording is being marked by the VISS (VHS Index Search System) function. This will enable you to quickly find the recording at a later date.

- 6 If you want to avoid recording unwanted scenes press the "P/STILL" button. "RECP" will appear for a few seconds on the TV screen. To continue recording press the "P/STILL" button again.
- 7 Press the "STOP" button to stop recording. "STOP" will appear for a few seconds on the TV screen.

Using the video recorder to record

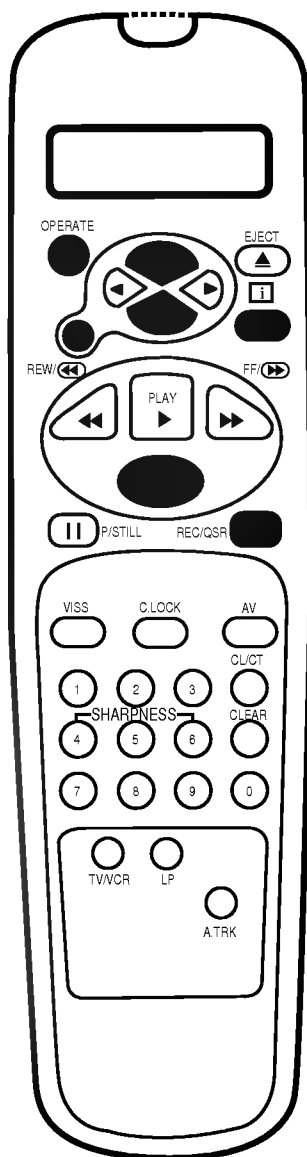

Recording one TV programme while watching another

You can record one programme while watching another by selecting the channel you watch on your TV set.

- 1** Start a recording by following above steps 1 to 5.
- 2** Select the TV station you want to watch with the programme channel selector on your TV set.

Immediate timer (QSR)

When making a recording you can set your video recorder to stop after a set period of time.

- 1** Press the "REC/QSR" button to start recording.
- 2** Press the "REC/QSR" button several times until the desired recording time is shown on the video recorder's Display.

Each time you press this button the QSR time will be extended by 30 minutes. The maximum time that can be set is 9 hours.

When the QSR recording have been completed, the video recorder will stop and switch itself off.

- 3** To cancel a QSR recording, press the "OPERATE" or the "STOP" button.

Selection of the colour system

Because your video recorder is equipped with dual colour standard, you can playback recordings in PAL B/G and SECAM D/K.

During playback your video recorder detects the recorded colour system automatically. Only if there are colour problems with very weak recordings, you should select the colour system manually:

- 1** Press the "i" button to display the Main menu.
- 2** Press the cursor "∧" and "∨" buttons to select the "Set-up" menu and press the "OK" button.
- 3** Press the cursor "∧" and "∨" buttons to select the "System".
- 4** Use the "OK" button to switch among:
 - "AUTO": automatic colour selection,
 - "PAL": PAL recordings
 - "MESECAM": MESECAM recordings
- 5** Press the "i" button to remove the menus from the TV screen.

System	AUTO
RF AUDIO	B/G
16:9	OFF
OSD	ON
Audio	STEREO
Audio mix	OFF
Language	English
Set	
Select	: ∨, OK
End	: i

Programming the video recorder timer

Recorder timer programming using the On Screen Displays

The timer allows you to record broadcasts automatically. Up to 6 recordings within one month can be programmed at the same time.

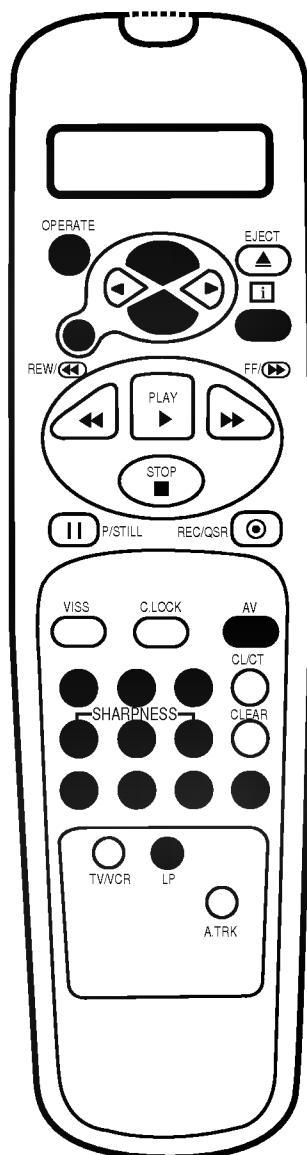

1 Press the "i" button, select "Timer programme" with the cursor "▲", "▼" buttons and press the "OK" button.

2 Press the "OK" button to enter the timer programming mode.

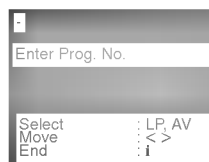

3 Select the programme number that you wish to record using the number buttons.

Programme number and dates 1 must be entered as 01, 2 as 02 etc.

- If you want to record from either of the EURO SCART socket or from the AUDIO/VIDEO input terminals, repeatedly press the "AV" button for the correct display.
- If you want to change the record mode, press the "LP" button.
LP: for Long play.
SP: for Standard play.

4 Enter the day using the number buttons.

If you want to change recording type:

- 1) Press the "OK" button.
 - **Daily:** for daily recordings from Monday to Friday.
 - **Weekly (SUN to SAT):** To record a programme at the same time every week.
- 2) Select the recording type with the cursor "▲" and "▼" buttons and select it with the "OK" button.

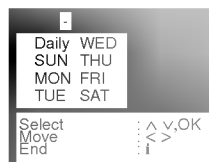
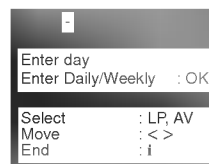

RECORDING

Programming the video recorder timer

RECORDING

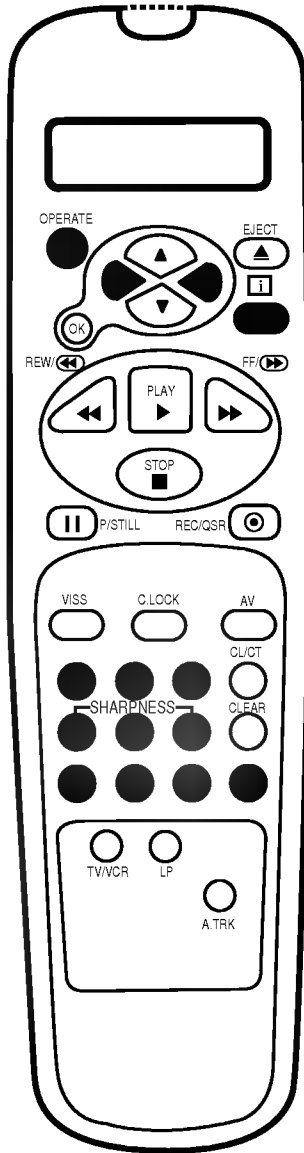

5 Enter the start and end times using the number buttons.

- For setting programme times you must use the 24 hour clock.
- Errors can be corrected with the “<” and “>” buttons.

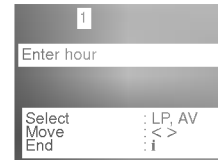

6 Finish your timer inputs with the “i” button.

A menu of the timer programmes set into the video recorder will be displayed on the TV screen.

- If “Please correct the data !” is displayed, you have entered a wrong data. Please correct the data.

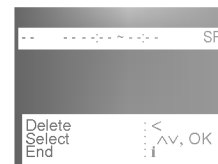

7 Press the “i” button to remove the menus from the TV screen.

8 Make sure that there is a video cassette in the video recorder and switch the video recorder off with the “OPERATE” button.

The timer set  symbol is shown on the video recorder.

NOTE: *Timer recordings do not work during energy saving mode.*

Programming the video recorder timer

Checking and clearing stored timer programmes.

The stored timer programmes can easily be viewed on the TV screen, and can also be cleared if not wanted.

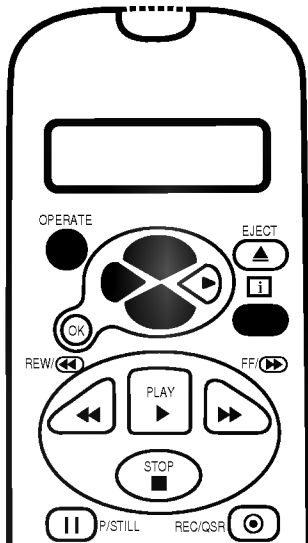

- 1** Press the "i" button.
The Main menu appears on the screen.
- 2** Select "Timer programme" with the cursor ^ and v buttons and press "OK" button. The timer programmes list will be displayed on the TV screen.
- 3** If you wish clear any of the programmes on the list, select it with the cursor ^ and v buttons, and press the "<" button to clear.
- 4** If you wish change any of the data for any of the programmes on the list, select it with the cursor ^ and v buttons, and press the "OK" button. The timer menu will be displayed. Change the data as described on previous page.
- 5** Press the "i" button twice to remove the menus from the TV screen.

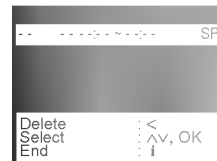

Overlapping timer programmes.

When timer programmes overlap, the programme which is already recording continues to its scheduled end time. Hence the beginning of the second programme will not be recorded.

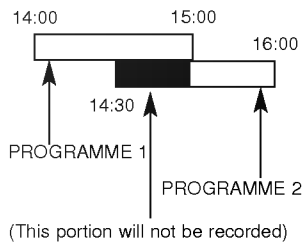

NOTE - If you wish to stop a timer recording which has already started, press the "OPERATE" button.

Other features

Introduction

This video recorder has a number of other features which make it easier and more convenient to use. Some of these are described in this section of the manual. Later sections describe the connection of the video recorder to other equipment, and features relating on the video recorder.

The features described here are:

- 1** The On Screen Display of the time or tape counter, date, programme channel and operation mode of the video recorder.
- 2** The Digital Tape Counter.
- 3** The Memory Stop facility that can be used during rewind to stop the tape at a preset point.
- 4** The tracking control that optimises the picture quality.
- 5** The Automatic Playback facility which plays back a tape, rewinds and ejects it and switches off the video recorder.
- 6** Automatic Memory Power Shut Off when a video cassette is rewound.
- 7** Automatic Switch Off when the TV station stops broadcasting.
- 8** A Child Lock facility so that the video recorder can be controlled only from the handset.
- 9** The 16:9 wide-screen recording and playback.
- 10** Self-diagnosis.
- 11** The VISS (VHS Index Search System) to help you find the beginning of each recording on a video tape easily and quickly.

Other features

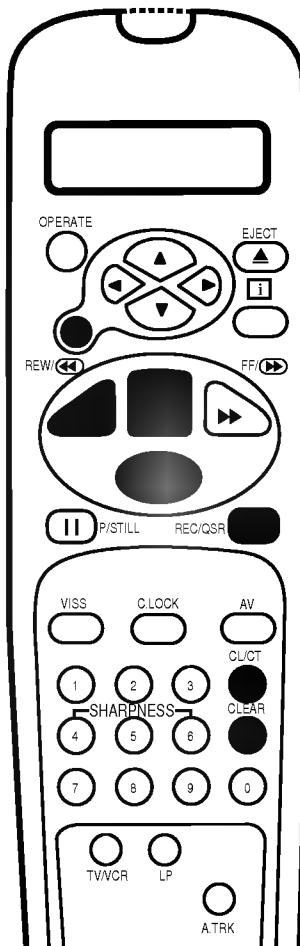
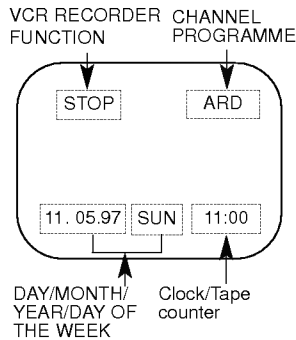

On Screen Display of the time or date, programme channel and operation mode of the video recorder.

When the "OK" button is pressed, a display occurs on the TV screen of the current time or the tape counter, the date, year and day of the week, the programme channel and the operation mode of the video recorder. After two seconds this display will disappear, if the "OK" button is pressed twice in quick succession on the clock display will remain on the TV screen. Pressing the "CL/CT" button will change this display to the Tape Counter display. Press the "OK" button again to remove the display from the TV screen.

NOTE:

- If a recording is taking place these On Screen displays will not be recorded onto the tape.

Digital Tape Counter

The Digital Tape Counter can be displayed on the video recorder's display instead of the time by repeatedly pressing the "CL/CT" button.

The Digital Tape Counter gives you the relative positions of recordings on the tape. If you set the counter to 0:00:00 at the beginning of a tape, you can note the counter reading at the beginning of each separate recording.

To set the counter to 0:00:00 press the "CLEAR" button.

The memory stop facility

Memory Stop automatically stops a tape when the tape counter is 0:00:00. This feature may be used to return the tape to a pre-selected position immediately after making a recording, or to repeatedly playback a portion of a tape.

- 1 Press the "CL/CT" button to set the display to the counter.
- 2 Before playback or recording, press the "CLEAR" button. The counter will read 0:00:00.
- 3 Begin the playback or recording. The tape counter gives the actual time in hours, minutes and seconds.
- 4 Press the "STOP" button when playback or recording is completed.
- 5 Press the "REW" button. The tape will rewind and automatically stop when the counter returns to 0:00:00.

Other features

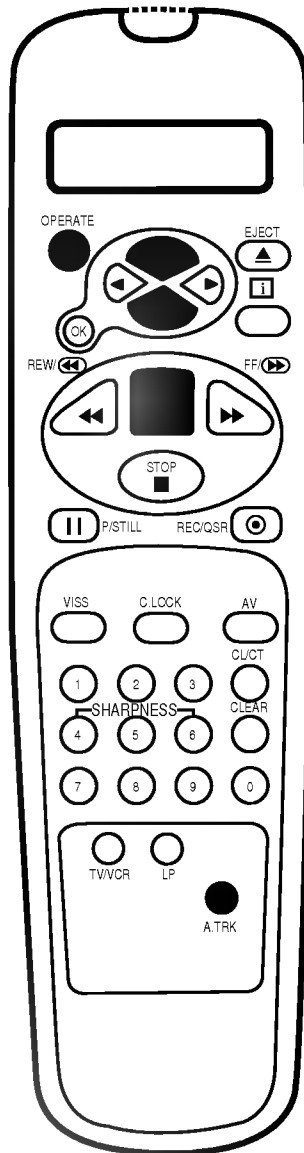

Tracking Controls

Tracking distortions show up as streaks or an unstable picture. This video recorder can set the tracking automatically. You can also set the tracking manually if you need to do so.

Automatic tracking - The automatic tracking adjusts the tracking to playback a tape with the optimum picture quality. As soon as you start to playback a tape the tracking will be adjusted if necessary.

A.TRK is shown on the video recorder's display.

Manual tracking - If the quality of the recording is poor, or if the tapes are damaged, the automatic tracking will not be able to work correctly. In these cases you will have to remove tracking distortions manually.

You can adjust the tracking during playback with the cursor "▲" and "▼" buttons. Press them repeatedly until the distortions have been eliminated.

You can switch on the automatic tracking again after using the manual tracking feature by pressing the "A.TRK" button. When you change a video cassette, the automatic tracking will always be switched on again.

Automatic Playback

Automatic Playback is a very convenient automatic action of this video recorder. It occurs whenever you insert into the video recorder a video cassette from which the safety tab has been removed (e.g. a video cassette which you have hired).

Automatic Playback carries out the following procedures:

It automatically switches on the video recorder's power and starts to playback the tape.

At the end of the tape, it automatically rewinds.

The tape is ejected automatically.

The video recorder switches itself off.

Automatic Memory Power Shut-Off

This feature of the video recorder enables you to initiate switching off the video recorder during tape rewind. Hence you do not have to wait until a tape has rewound before you can switch the video recorder off.

To activate Automatic Memory Power Shut Off press the "OPERATE" button during tape rewind. The tape will rewind to the beginning and the video recorder will switch itself off.

Pressing any of the control buttons (e.g. "OPERATE" or "PLAY") after setting Automatic Memory Power Shut Off will cancel it.

Automatic Switch Off

The video recorder will turn itself off after 8 minutes when not receiving a TV signal. This will occur when TV broadcasts have finished.

Other features

The Child Lock

The control buttons on the front of the video recorder are inoperative. The video recorder can be controlled only from the handset.

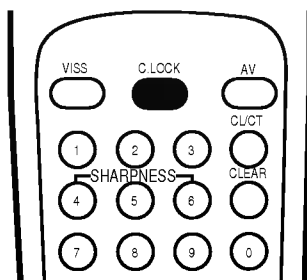

- 1 Press the "C.LOCK" button. "LOCK ON" appears on the video recorder's Display.

The control buttons on the front of the video recorder are inoperative (except for "STOP/EJECT"). The video recorder can be controlled only from the handset.

If any of the other controls on the video recorder are pressed "LOCK ON" appears on the video recorder's Display.

- 2 To switch off the locking, press the "C.LOCK" button again. "LOCK OFF" appears on the video recorder's Display.

16:9 Compatibility (Wide - screen TV)

This video recorder can be recorded and played back the 16:9 wide aspect ratio programmes.

Select the required position in the "Set-up" menu as described on page 9:

To record in a wide-screen format, you have to set to "16:9 ON", or if you set to "16:9 OFF" the video recorder will be recorded in normal format.

When you set to "16:9 AUTO", the video recorder will be automatically played back the wide-screen programmes as wide, the normal programmes as normal.

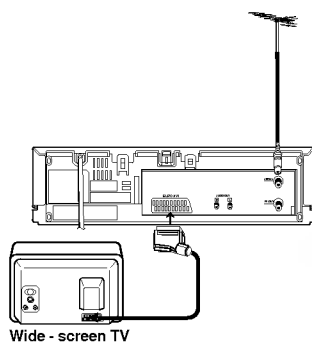

NOTES:

- When the picture disappears on the TV screen while playing back a 16:9 programme or recording in 16:9 format, set the TV to "AV" mode.
- This function works only when this VCR is connected to a TV with EURO SCART cable (SCART to SCART).

Self-Diagnosis

This function informs you of an error messages for solving the problems more easily.

These error messages will be shown on the video recorder's display or on the TV screen.

STATUS OF DISPLAY	SOLUTION
PROTECTED	Insert a cassette with it's safety intact.
SEE CABLE	Connect the video recorder to your TV aerial and TV set.
Dust on the head!	Try to clean the video head.

Other features

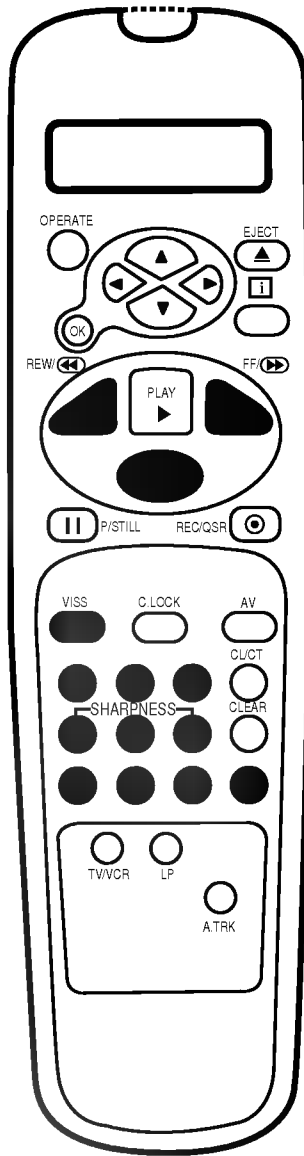

The VHS Index Search System (VISS)

VISS allows you to find the beginning of each recording on a tape easily and quickly. The video recorder automatically puts an index mark on the tape whenever you start a recording, and the VISS searches for these index marks.

AUTOMATIC VISS MARKING

At the beginning of each recording, a VISS mark is recorded automatically on the tape. This is indicated by MARK appears on the video recorder's display.

VISS SCANNING

A VISS scan gives you a quick overview of the recordings on the video cassette.

To carry out a VISS scan:

- 1** Insert the video cassette.
- 2** Whilst the video recorder is on stop press the "VISS" button.
- 3** Press the "REW" or "FF" button to fast forward or rewind the tape. "VISS" is shown on the video recorder's display.
- 4** The tape winds on to the next VISS mark, switches to playback for a short time, so that you can view the tape at that point, and then winds on to the next VISS mark.
- 5** You can switch off the VISS scan at any time by pressing the "VISS" button or "STOP" button.

VISS SEARCHING

A VISS search is very similar to a VISS scan. Here you enter the desired mark with the number buttons. For example, if you want to find the fifth mark after (on fast forward) or before (on rewind) the present tape position, you enter 05. The VISS marks are not numbered, but the video recorder counts the marks during the winding and will switch to playback as soon as the entered number is reached.

To carry out a VISS search:

- 1** Insert the video cassette.
- 2** Whilst the video recorder is on stop press the "VISS" button.
- 3** Use the number buttons to enter the number at which mark the playback is to start.
- 4** Press the "REW" or "FF" button to fast forward or rewind the tape.
- 5** The tape winds on to the requested VISS mark, and the video recorder switches to playback.

Connection to other equipment

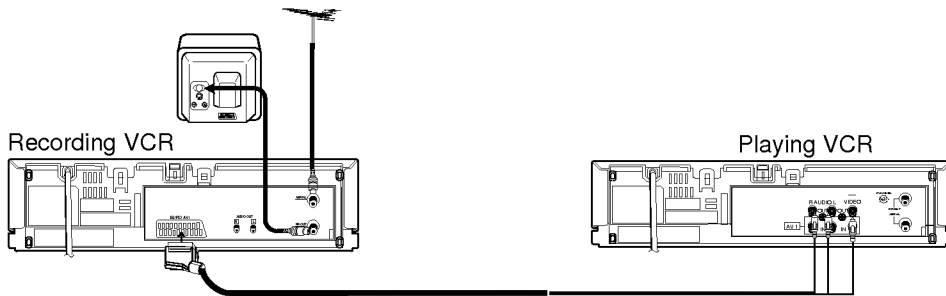

Connection to another video recorder

Your new video recorder has EURO SCART SOCKET. A second external unit, such as a second video recorder, a satellite receiver or a CD video player, can be connected to the EURO SCART sockets on the back of the vide recorder.

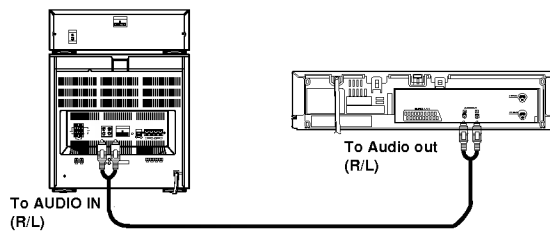

Connection to an audio system

An audio system can be connected to the AUDIO IN (L/R) and AUDIO OUT terminals on the back of the video recorder.

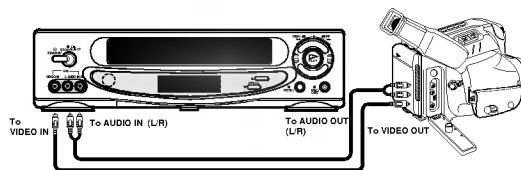

Recording from a camcorder

This video recorder can record from a camcorder using the AUDIO IN (L/R) and VIDEO IN terminals on the front panel. The recording input source must be set to "A2 (AV2)" with the AV button on the remote handset.

The Hi-Fi stereo sound system

Introduction

This video recorder will record and playback Hi-Fi stereo sound. There are, therefore, several possible ways of recording and playing back the sound. These are described below.

The audio tracks

Video cassette tapes recorded on this video recorder will have a normal mono audio track and two VHS Hi-Fi stereo audio tracks. These allow you to make audio recordings in Hi-Fi stereo or bilingual mode from a TV broadcast, a stereo audio system, a video disc or another video recorder.

Using your video recorder in combination with a Hi-Fi audio system will enhance the sound quality of video tapes.

TYPE OF BROADCAST	AUDIO TRACKS		
	MONO TRACK	HI-FI TRACKS	
		L-CH	R-CH
STEREO	L-CH+R-CH	L-CH	R-CH
BILINGUAL	L-CH (Main)	L-CH (Main)	R-CH (Sub)
MONO	MONO	MONO	MONO

STEREO, BILINGUAL and MONO SOUND

The Stereo sound decoder allows you to receive broadcasts with stereo, bilingual and mono sound.

STEREO AUDIO RECORDING- A TV broadcast being transmitted in Stereo sound mode will display STEREO on the TV screen. During recording stereo sound will automatically be recorded on the Hi-Fi stereo tracks of the video tape, and in mono on the mono track.

BILINGUAL AUDIO RECORDING- A TV broadcast being transmitted in Bilingual sound will display BIL on the TV screen. Both audio channels will automatically be recorded on the Hi-Fi stereo tracks of the video tape, and the main channel (left) will be recorded on the mono track.

(WITH MIXING OFF)

AUDIO MODE	RF OUT	AUDIO OUT TERMINALS	
		LEFT CH.	RIGHT CH.
STEREO	LEFT & RIGHT	LEFT	RIGHT
LEFT CH.	LEFT	LEFT	LEFT
RIGHT CH.	RIGHT	RIGHT	RIGHT
MONO	MONO	MONO	MONO

(WITH MIXING ON)

AUDIO MODE	RF OUT	AUDIO OUT TERMINALS	
		LEFT CH.	RIGHT CH.
STEREO	LEFT & RIGHT & MONO	LEFT & MONO	RIGHT & MONO
LEFT CH.	LEFT & MONO	LEFT & MONO	LEFT & MONO
RIGHT CH.	RIGHT & MONO	RIGHT & MONO	RIGHT & MONO
MONO	MONO	MONO	MONO

Audio output during playback

The audio output mode during playback is that chosen in the "Set-up" menu. The choice is STEREO, L-CH (left channel), R-CH (right channel) or MONO.

The audio output signals also depend on whether MIX is set OFF or ON in the "Set-up" menu.

The output at the RF terminal and the AUDIO OUT terminal on the back of the video recorder are given in the table.

NOTE that whilst adjusting the auto tracking control Hi-Fi stereo sound may revert to mono sound.

BILINGUAL AUDIO OUTPUT - If the audio output is bilingual the primary language is output from the left channel, and the secondary language is output simultaneously from the right channel when the audio setting is STEREO. The primary language is output from both channels when the audio setting is MONO.

Recording from another equipment

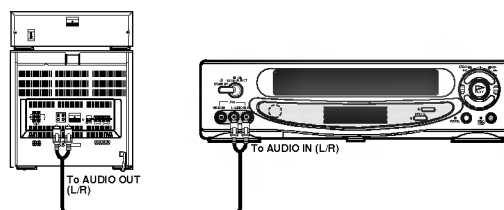

Simulcast stereo recording and playback Recording

Some TV programmes is also broadcast in stereo sound on FM radio. For these simulcast broadcasts you can record the picture from the TV programme, and the sound from your audio system as follows:

- 1** Connect your audio system to the "AUDIO IN (L/R)" (11) on the front of the video recorder.
- 2** Select "SC" mode with the "AV" button (11) on the remote control handset.
- 3** Select the programme to be recorded with the handset.
- 4** Turn on your audio system and tune in to the sound broadcast.
- 5** Start recording.

NOTE: The Simulcast Stereo audio will be recorded on the Hi-Fi Audio tracks.
The Normal (Mono) audio track will record the TV programme FM mono sound.

PLAYBACK

You can play back the stereo sound through a stereo TV set. To playback the stereo sound through your audio system, connect it to the "AUDIO OUT" terminals on the back of the video recorder. Turn off the sound on your TV set.

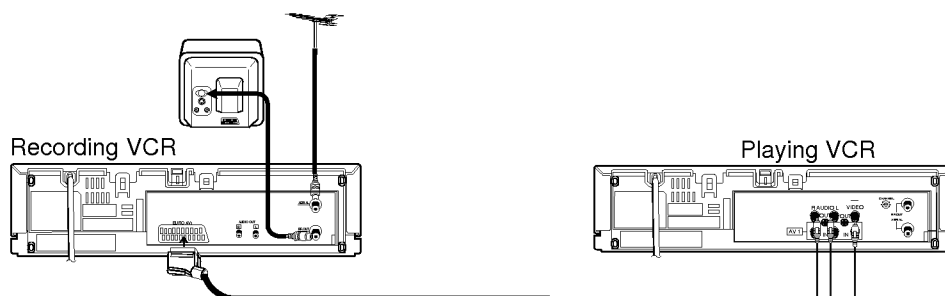

Recording from a second video recorder (for tape copying)

- 1** A second video recorder (for tape copying) should be connected to the "AUDIO IN (L/R)" and VIDEO IN terminals on the front of the video recorder or on the back (see "Connection to other equipment" (page 29)).
- 2** The appropriate audio/video mode should be set with the "AV" button.
- 3** Insert an empty cassette into this video recorder, and if you are copying another tape insert it into the second video recorder.
- 4** Start recording on this video recorder, and if appropriate, the playback at the second video recorder.

NOTE - Unauthorised recording of copyrighted TV programmes, films video cassette and other materials may infringe the rights of copyright owners and be contrary to copyright laws.

Specifications

General

Power	: 100-240V~, 50Hz.
Power consumption	: Approx. 19 watts (Energy saving mode: 3 watts)
Video Head system	: Double azimuth 4 heads, helical scanning system
Tape speed	: 23.39 mm/sec (SP mode)/11.69 mm/sec (LP mode)
Tape format	: Tape width 1/2" (12.7 mm high density VHS tape)
Maximum recording time	: 4 hours in SP mode/8 hours in LP mode (with E-240 tape)
Rewind time	: Approx. 150 sec. (with E-180 tape)
Dimensions (W X H X D)	: 14.2" X 3.6" X 11.4" (360 X 88 X 290 mm)
Weight	: 9.0 lbs. (4.1 kg)
Operating temperature	: 41°F-95°F (5°C-35°C)
Operating humidity	: Less than 80 %
Timer	: 24 hours display type

Video

Television system	: CCIR standard (625 lines, 50 fields) PAL/SECAM colour signal
Recording format	: PAL/MESECAM
RF reception	: PAL/SECAM (B/G, D/K)
RF OUT	: PAL G
Input level	: VIDEO IN (SCART, RCA type) 1.0 Vp-p, 75 ohm, unbalanced
Output level	: VIDEO OUT (SCART type) 1.0 Vp-p, 75 ohm, unbalanced
Signal to noise ratio	: More than 43 dBm
RF modulator	: UHF channels 22-68 (adjustable)

Audio

Input level	: AUDIO IN (SCART, RCA type) SCART type: 0 dBm, more than 10 k Ω RCA type: -4.0 dBm, more than 47 k Ω
Output level	: AUDIO OUT (SCART, RCA type) SCART type: 0 dBm, less than 1 k Ω RCA type: -4.0 dBm, less than 1 k Ω
Audio track	: Mono track & Hi-Fi track
Audio frequency response	: Normal: 100 Hz-10 kHz (-6/+3 dB) Hi-Fi: 20 Hz-20 kHz (-3/+3 dB)
Audio signal to noise ratio	: Hi-Fi audio: More than 68 dB (JISA filter)
Audio dynamic range	: Hi-Fi audio: More than 75 dB (JISA filter)

- *Design and specifications are subject to change without notice!*

Before calling for service...

Please check to see if any problem which you may have with your video recorder is described here before taking it for service or calling a service engineer.

Problem	Possible solution?
No mains power to the recorder	<ul style="list-style-type: none"> • Is the video recorder plugged into the mains? • Is the mains supply on and switched on?
TV programmes cannot be recorded	<ul style="list-style-type: none"> • Can you get a picture on the TV screen? • If are not the aerial and RF lead connected? • Are the TV channels properly tuned in? • Has the safety tab been removed from the video cassette to prevent recording?
A timer recording does not take place	<ul style="list-style-type: none"> • Is OPERATE off?(Is the Timer symbol showing in the display?) • Is stand by LED light? • Were the recording start and end times set correctly? • Are the timer settings in the timer menu? • Was the power interrupted after setting the timer? If so the time setting will be erased and timer recordings will not take place.
AUTO PLAY does not work	<ul style="list-style-type: none"> • Has the safety tab been removed from the video cassette?
There is no picture on playback, or it is noisy and streaky	<ul style="list-style-type: none"> • Are the TV channels properly tuned in? • Try another video cassette. • Can you minimise the noise bars to an acceptable level with the "A.TRK" or " ^ " and " v " buttons?
The top of the playback picture is unstable	<ul style="list-style-type: none"> • Is the video cassette damaged? Try another one. • Adjust the horizontal hold control on you TV set.
Video cassettes cannot be inserted	<ul style="list-style-type: none"> • Is the cassette compartment empty? • Are you trying to insert the cassette the right way round?
No Hi-Fi sound	<ul style="list-style-type: none"> • Switch "Audio" in the Set-up menu to "STEREO".

SAFETY PRECAUTION

THIS EQUIPMENT MUST BE DISCONNECTED FROM THE MAINS POWER SUPPLY WHEN IT IS NOT IN USE. DO NOT ALLOW THIS UNIT TO BE EXPOSED TO RAIN OR MOISTURE.

CAUTION

TO PREVENT ELECTRIC SHOCK, DO NOT REMOVE THE COVER. NO USER SERVICEABLE PARTS ARE INSIDE. REFER SERVICING TO QUALIFIED PERSONNEL.

WARNING

THE RECORDING AND PLAYBACK OF CERTAIN MATERIAL MAY NOT BE DONE WITHOUT PERMISSION.

The working life of this set is 7 years since the date of delivery to consumer. Upon the expiry of the said period, it might be unsuitable for the use according to their designation.

PRECAUTIONS

Please read these precautions before you operate this unit.

- Avoid extreme heat, cold, moisture and dust.
- Avoid using near a magnetic field. (This will adversely affect the units performance.)
- Be careful when the surface of the case is wiped with a volatile agent such as benzene, alcohol, thinner, etc. or a chemically processed cloth, the surface finish may deteriorate or its coating may peel.
- Use the unit only in a horizontal position, and do not place anything heavy on it.
- Keep the unit away from flower vases, tubs, sinks, etc. If any liquids should spill into unit, serious damage could occur. In that case, please consult qualified service personnel.
- Do not obstruct the ventilation holes: they prevent overheating. Even soft materials such as paper and cloth may prevent proper ventilation of the unit.
- **There are no serviceable parts inside. For service, please contact your service centre.**

JEDDAH MAIN SERVICE CENTER
P.O.BOX 704, JEDDAH 21421 KINGDOM OF SAUDI ARABIA
TEL) 02-629-2929

JEDDAH QUICK SERVICE CENTER
TEL) 02-663-3888 EXT. 340,343

RIYADH BRANCH SERVICE CENTER
TEL) 01-461-5559

AL KHOBAR BRANCH SERVICE CENTER
TEL) 03-857-2629/2637

MOISTURE CONDENSATION

If you pour a cold liquid into a glass, water vapor in the air will condense on the surface of the glass. This is moisture condensation. Moisture condensation on the head drum, one of the most crucial parts of the unit, will cause damage to the tape.

When this set is exposed to a rapid temperature change from cold to warm, some condensation will occur. Under this condition, connect the power cord to the AC line, press **OPERATE** button on and allow at least two hours for the unit to dry out.

VIDEO HEAD CLEANING

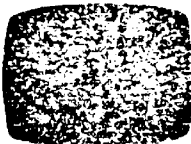

- Whenever a video cassette is inserted into or ejected from this unit the video head is automatically cleaned.
- However, it is possible that the heads may become clogged when playing an old or damaged tape. If the image on your screen resembles the picture on the left while playing back a tape, the heads may require cleaning.
- To clean the heads, obtain a head cleaning tape from your local video dealer. Follows the instructions that come with the cleaning tape, as excessive use can shorten head life.



P/N: 3834RP0027C