



Room Air Conditioner OWNER'S MANUAL

CONVERTIBLE TYPE ROOM AIR CONDITIONER

- Please read carefully and thoroughly this manual before operating this unit.
- Contact the authorized SVC man for repair or maintenance of this unit.
- Contact the installer for installation of this unit.

- Prior to installation, this air-conditioning unit must be submitted for approval by the utility service which provides electricity (EN 60555-3 Norm).

CONTENTS

PRODUCT COMPONENT IDENTIFICATION	3
(1) Feature	3
(2) Indoor Unit, Outdoor Unit	4
(3) Name and Function-Remote Controller	5
(4) Remote Controller Preparation	7
AIR CONDITIONER OPERATION	8
(1) Operation Mode	8
(2) Operation Procedure	8
(3) Sleep Mode Auto-Control Setting	14
(4) Airflow Direction Procedure	15
(5) Setting the Present Time	16
(6) Timer Setting	17
(7) Operation Details	19
FORCED OPERATION	20
CARE AND MAINTENANCE	21
OPERATION TIPS	23
CAUTION	24
BEFORE CALLING FOR SERVICE	25

PRODUCT COMPONENT IDENTIFICATION

(1) Feature

1 Soft Dry Operation Mode (page 10)

This mode is designed to dehumidify without overcooling.

2 Natural wind by CHAOS logic (page 19)

This mode automatically controls the indoor fan speed and creates the feeling of a pleasant breeze like a natural wind by CHAOS logic.

3 Auto Operation (page 13)

In selecting this mode of operation, the setting temperature, indoor fan speed, and the desired operation mode are automatically set by Fuzzy rule on the basis of sensing the room temperature.

4 ON/OFF Dual Timer Setting (page 17)

You can program the room air conditioner to turn itself on or off so as to ensure you maximum comfort when you return from being away.

5 Sleep Mode Auto Control (page 14)

A touch of the Sleep Mode Button automatically controls the indoor fan speed, and adjusts the setting temperature to create a more comfortable sleep.

6 Auto Air Swing

Air direction louvers automatically swing up and down to increase comfort through uniform air distribution.

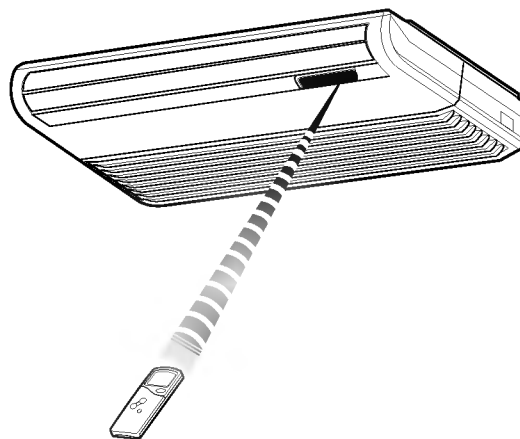

Wireless Remote Controller puts all functions at your fingertips.

CAUTION

of handling the Remote Controller

- Aim at the signal receptor on the room air conditioner so as to operate.
- The remote control signal can be received at a distance of up to about 7m.
- Be sure that there are no obstructions between the remote controller and the signal receptor.
- Do not drop or throw the remote controller. Do not place the remote controller in a location exposed to direct sunlight, or near the heating unit, or any other heat source.
- Block a strong light over the signal receptor with a curtain or etc. so as to prevent the abnormal operation.
(ex: electronic quick start, ELBA, inverter type fluorescent lamp)

(2) Indoor Unit, Outdoor Unit

Indoor Unit

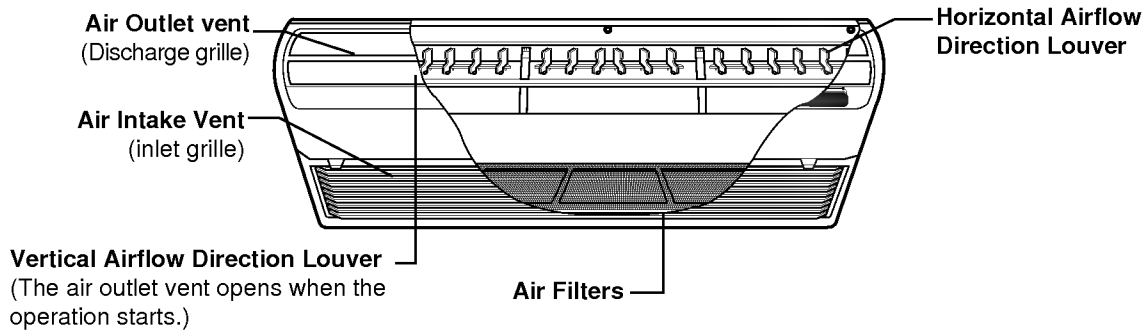

Indoor unit controls and indicators

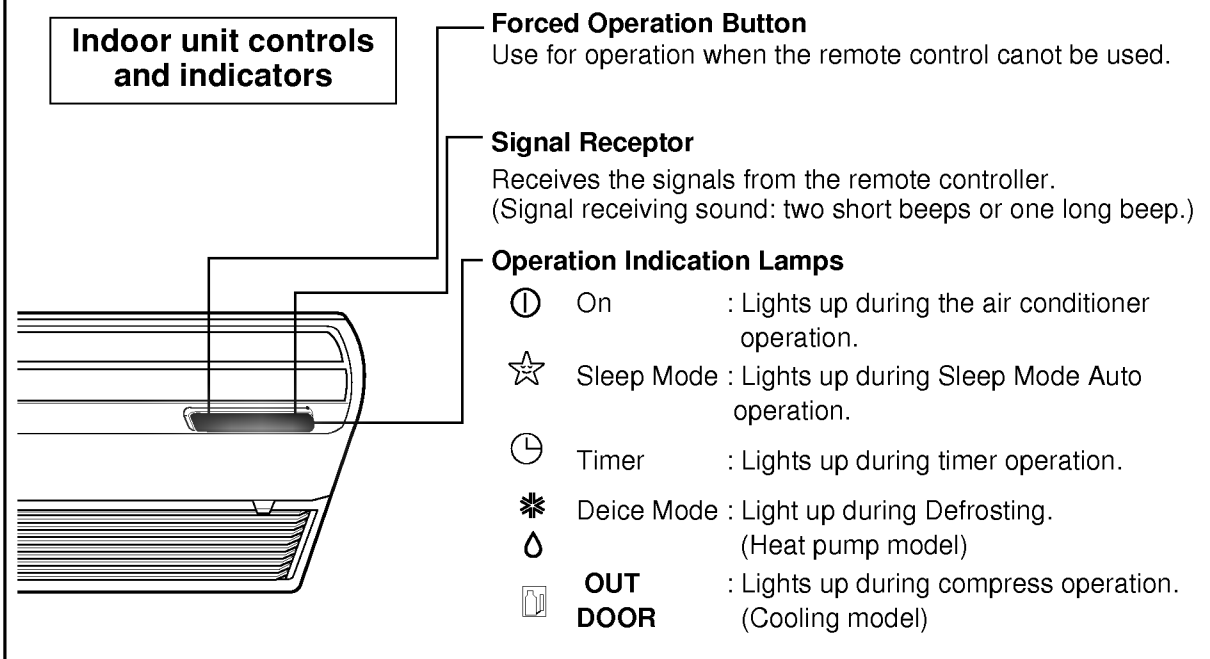

Outdoor Unit

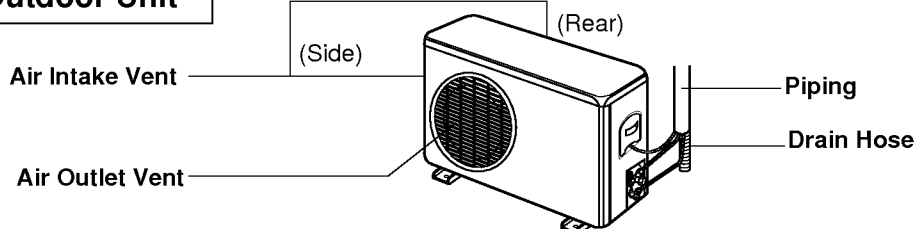

Heat pump model: Air Conditioner for cooling and heating
Cooling model: Air Conditioner for cooling

(3) Name and Function-Remote Control

1) Cooling Model

Remote Controller

Signal transmitter

Transmits the signals to the room air conditioner.

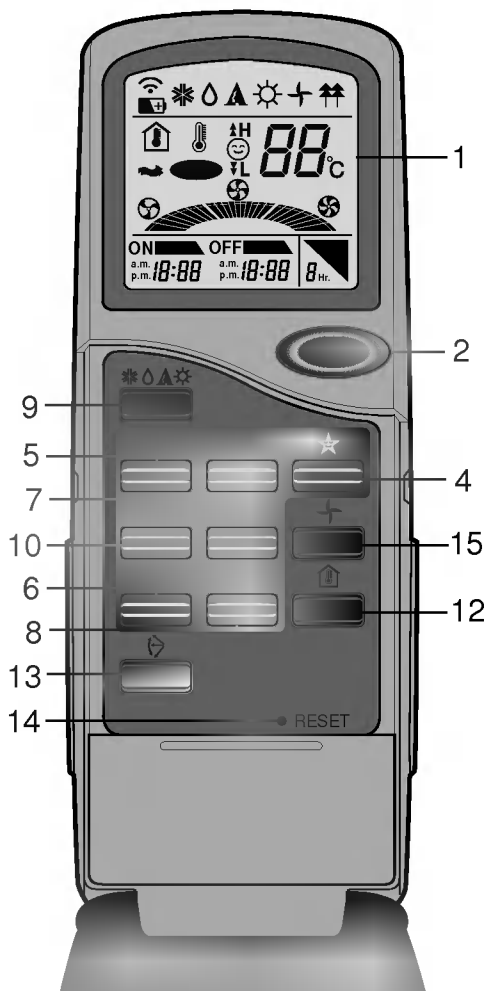

- 1 Operation Display**
Displays the operation conditions.
- 2 Start/Stop Button**
Operation starts when this button is pressed, and stops when the button is pressed again.
- 3 Indoor Fan Speed Selector**
Used to select the desired fan speed.
- 4 Sleep Mode Auto Button**
Used to set Sleep Mode Auto Operation.
- 5 ON Timer Button**
Used to set the time of starting operation.
- 6 Timer Set Button**
Used to set the timer when the desired time is obtained.
- 7 OFF Timer Button**
Used to set the time of stopping operation.
- 8 Timer CANCEL Button**
Used to cancel the timer operation.
- 9 Operation Mode Selection Button**
Used to select the operation mode.
 - Cooling Operation Mode.
 - Soft Dry Operation Mode.
 - Auto Operation.
- 10 Time Setting Button**
Used to adjust the time.
- 11 Room Temperature Setting Button**
Used to adjust the room temperature.
- 12 Room Temperature Checking Button**
Used to check the room temperature.
- 13 Vertical Airflow Direction Control Button**
Used to set the desired vertical airflow direction.
- 14 Reset Button**
- 15 Air Circulation Button**
Used to circulate room air without cooling.

2) Heat Pump Model

Remote Controller

Signal transmitter

Transmits the signals to the room air conditioner.

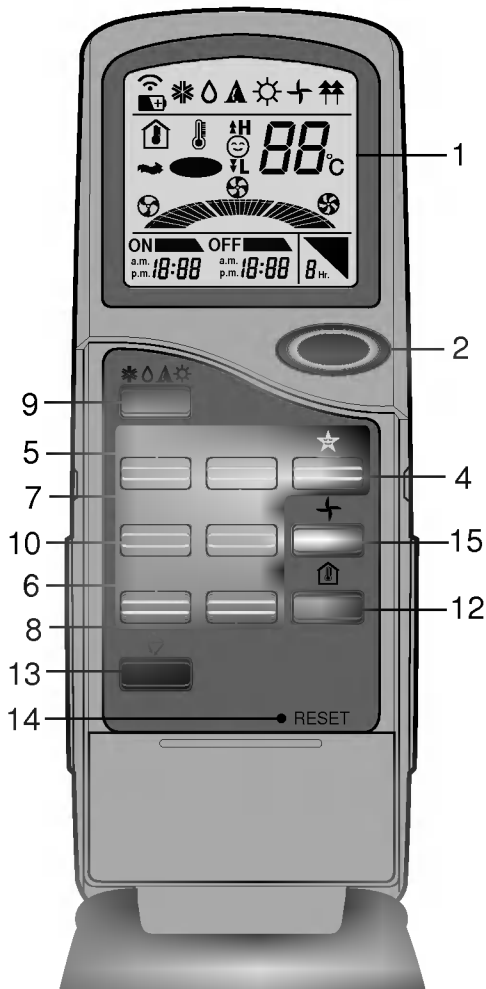

- 1 Operation Display**
Displays the operation conditions.
- 2 Start/Stop Button**
Operation starts when this button is pressed, and stops when the button is pressed again.
- 3 Indoor Fan Speed Selector**
Used to select the desired fan speed.
- 4 Sleep Mode Auto Button**
Used to set Sleep Mode Auto Operation.
- 5 ON Timer Button**
Used to set the time of starting operation.
- 6 Timer Set Button**
Used to set the timer when the desired time is obtained.
- 7 OFF Timer Button**
Used to set the time of stopping operation.
- 8 Timer CANCEL Button**
Used to cancel the timer operation.
- 9 Operation Mode Selection Button**
Used to select the operation mode.
 - Cooling Operation Mode.
 - Soft Dry Operation Mode.
 - Heating Operation.
 - Auto Operation.
- 10 Time Setting Button**
Used to adjust the time.
- 11 Room Temperature Setting Button**
Used to adjust the room temperature.
- 12 Room Temperature Checking Button**
Used to check the room temperature.
- 13 Vertical Airflow Direction Control Button**
Used to set the desired vertical airflow direction.
- 14 Reset Button**
- 15 Air Circulation Button**
Used to circulate room air without cooling.

(4) Remote Control Preparation

How to mount onto a wall

- 1** Use the screws to secure the holder to the wall.

Confirm that the remote control signals can reach the signal receptor of unit.

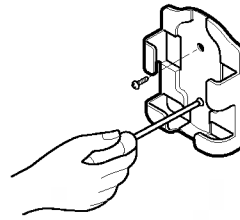

- 2** To attach the remote control to the holder.

(1) Hook

(2) Press

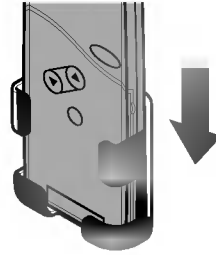

- 3** To remove.

(1) Pull

(2) Unhook

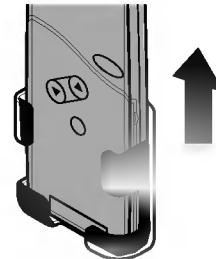

How to insert batteries

- 1** Remove the cover from the back of the remote controller.

- Slide the cover according to the arrow direction.

- 2** Insert two batteries.

- Be sure that the (+) and (-) directions are correct.
- Be sure that both batteries are new.

- 3** Re-attach the cover.

- Slide it back into position.

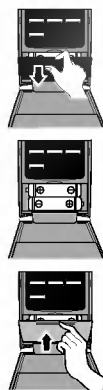

- Do not use rechargeable batteries, such as batteries differ from standard dry cells in shape, dimensions, and performance.

- Remove the batteries from the remote controller if the air conditioner is not going to be used for some long time.

AIR CONDITIONER OPERATION

(1) Operation Mode

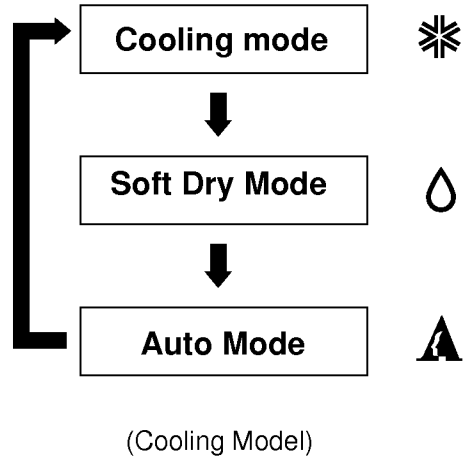
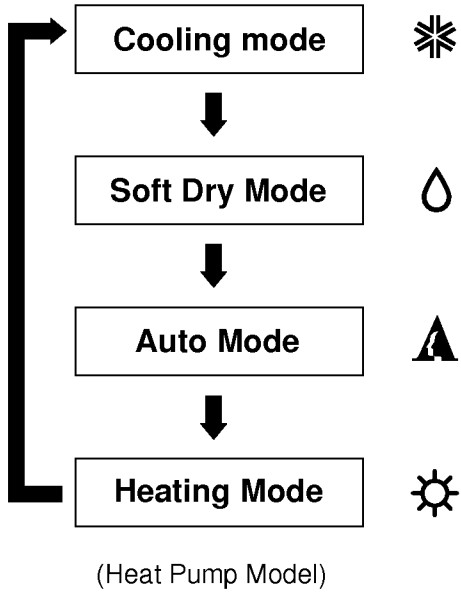

(2) Operation Procedure

- 1st** Start/Stop Button
- 2nd** Operation Mode Selection Button
- 3rd** Room Temperature Setting Button
- 4rd** Indoor Fan Speed Selector

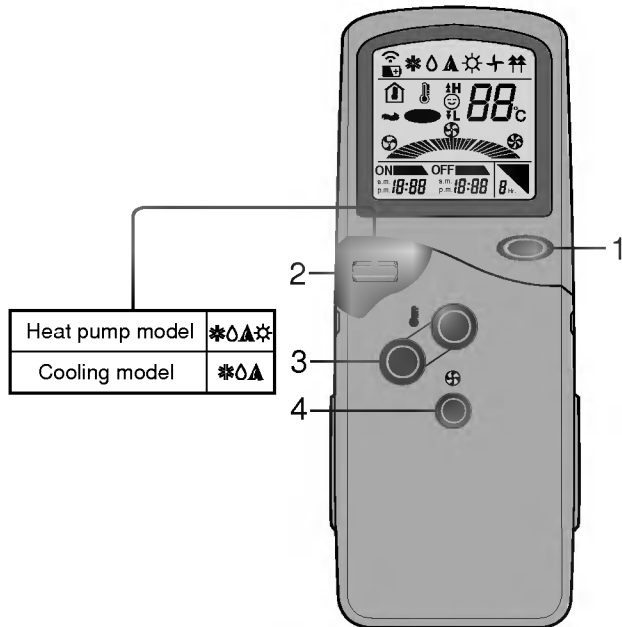

➤A Cooling Operation Mode

(① LED lamp ON)

1 Press the Start/Stop Button.

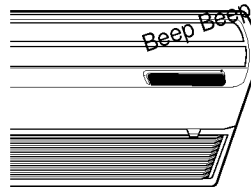

- Two short beep will sound and the operation lamp will light up.

2 Select Cooling Operation.

Press the Operation Mode Selection Button.

Each time the button is pressed, the operation mode is shifted in the arrow direction.

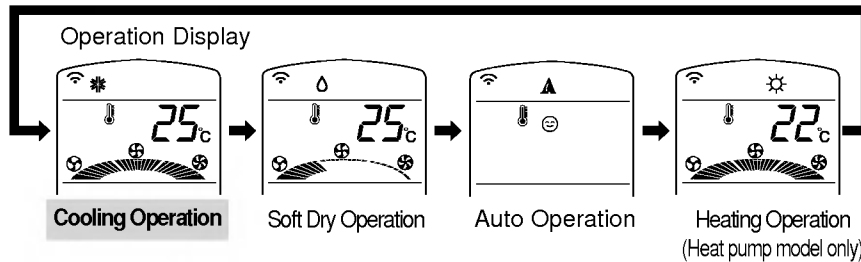

3 Set the temperature.



- The temperature can be set within a range of 18°C ~ 30°C by 1°C.

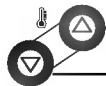

To raise the Temperature

To lower the Temperature

4 Set the fan speed.

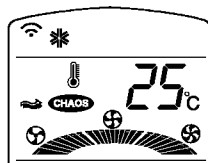

- Select the fan speed in four steps -low, medium, high, CHAOS.

- Each time the button is pressed, the fan speed mode is shifted.

➤B Soft Dry Operation Mode

This mode dehumidifies without overcooling.

(① LED lamp ON)

1 Press the Start/Stop Button.

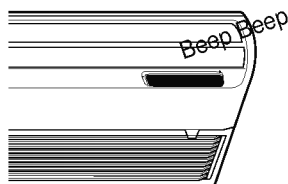

- Two short beeps will sound and the operation lamp will light up.

2 Select Soft Dry Operation.

Press the operation Mode Selection Button.

Each time the button is pressed, the operation mode is shifted in the arrow direction.

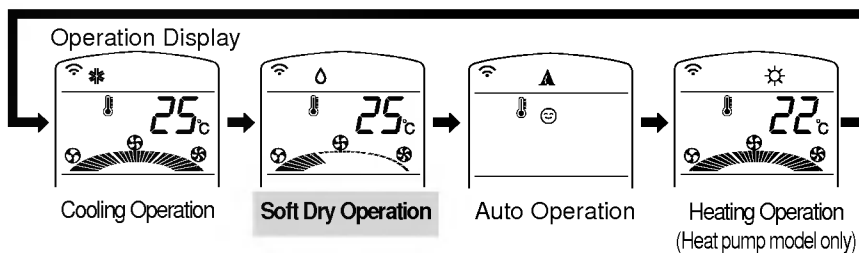

3 Set the temperature lower than the room temperature.



- The temperature can be set within a range of 18°C~30°C by 1°C.

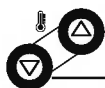

To raise the Temperature

To lower the Temperature

4 During Dry Operation

- The indoor fan speed is automatically set to the low, so the shift of the indoor fan speed is impossible because of already being set to the best speed for Dry Operation by Micom Control.
- The indoor fan may be stopped not so as to be the room overcooling.

◁ Air Circulation Mode(Cooling model only)

This mode is used to circulate room air without cooling.
(① LED lamp ON)

1 Press the Start/Stop Button.

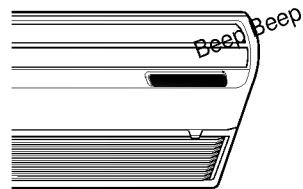

- Two short beep will sound and the operation lamp will light up.

2 Press Air Circulation Button.

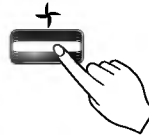

3 Each time the Air Circulation button is pressed, the fan speed mode is shifted in the arrow direction.

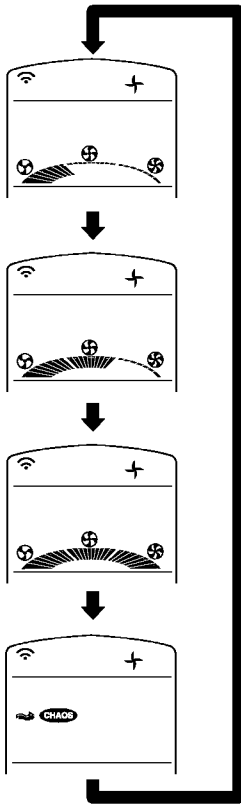

- Fan speed is low.
- Fan speed is medium.
- Fan speed is high.
- Natural Wind : Fan speed varies like a natural wind by chaos logic.

▷D Heating Operation Mode (Heat pump model only)

(Ⓛ LED lamp ON)

1 Press the Start/Stop Button.

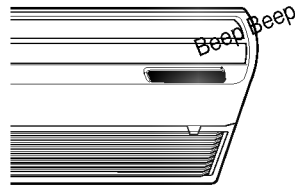

- Two short beep will sound and the operation lamp will light up.

2 Select Heating Operation.

Press the Operation Mode Selection Button.

Each time the button is pressed, the operation mode is shifted in the arrow direction.

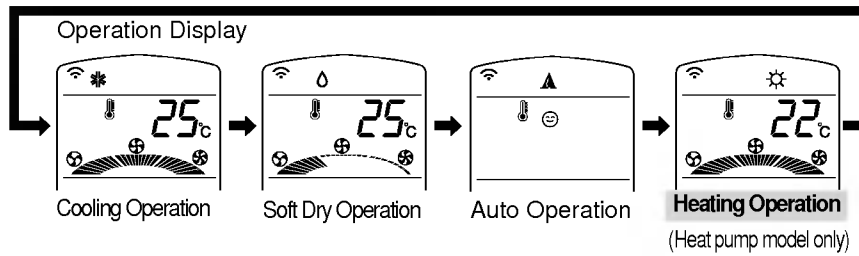

3 Set the temperature.



- The temperature can be set within a range of 16°C~30°C by 1°C.

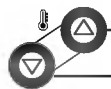

To raise the Temperature
To lower the Temperature

4 Set the fan speed.

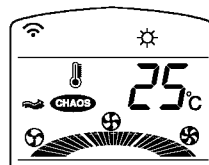



- Select the fan speed in four steps -low, medium, high, CHAOS.

- Each time the button is pressed, the fan speed mode is shifted.

➤ E Auto Operation Mode

(① LED lamp ON)

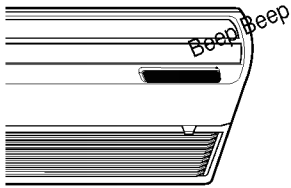
1 Press the Start/Stop Button.



- Two short beep will sound and the operation lamp will light up.

2 Select Auto Operation.

Press the Operation Mode Selection Button.
Each time the button is pressed, the operation mode is shifted in the arrow direction.



Operation Display

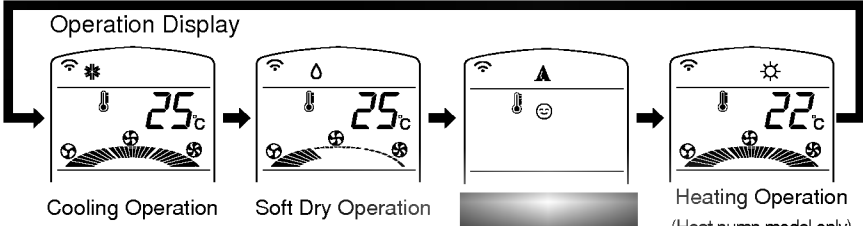

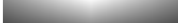
Cooling Operation Soft Dry Operation  Heating Operation
(Heat pump model only)

3 Set the temperature.

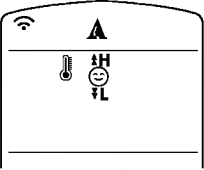

- Operation mode, set temperature and fan speed are automatically set by Fuzzy rule on the basis of sensing the room temperature.
- If you want to change the set temperature, press room temperature setting button.
- The cooler or warmer you feel, the more times (up to two times) you press the button.
- Then the set temperature will be changed automatically by micom control.



— To raise the Temperature. (When you feel too cool or cold)

— To lower the Temperature. (When you feel too warm or hot)

4 During Auto Operation.

- It is impossible to switch the indoor fan speed during Auto Operation because of being already set to the best position by Fuzzy rule.
- If the room air conditioner is not operating as desired, switch to cooling mode or other mode.
- During Auto Operation, pressing the Air-flow direction control button makes vertical louver swings up and down automatically according to 1/f rhythm. If you want to stop the 1/f swing of the vertical louver, press again the Airflow direction Control button.

(3) Sleep Mode Auto Control Setting

(★ LED lamp ON)

Remote Controller



- The Sleep Mode will be operated at a low fan speed(Cooling) or a med. fan speed(Heating) for quiet sleeping.

Press the Sleep Mode Auto Button.

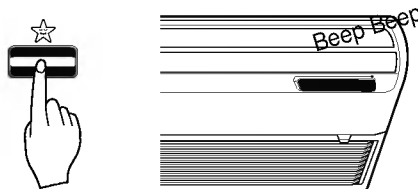

1. Press the Sleep Mode Auto Button and set the time to turn off.
2. Check the Sleep Mode Auto LED of the room air conditioner lights up.
3. The Timer is programmed by 1 hour each pressing the sleep mode auto button from 1 hour to 7 hours.

In Cooling mode

- The setting temperature will be automatically raised by 1 °C 30 minutes later and by 2 °C 1 hour later for comfortable sleeping.
- In order to cancel the Sleep Mode, press the button several times until star pictograph on the operation display disappears.

(4) Airflow Direction Procedure

✓A Vertical Airflow Direction Control

Airflow Direction Control

The airflow direction can be adjusted as desired by using the remote controller. This is effective when you want to cool yourself directly, such as after taking a bath.

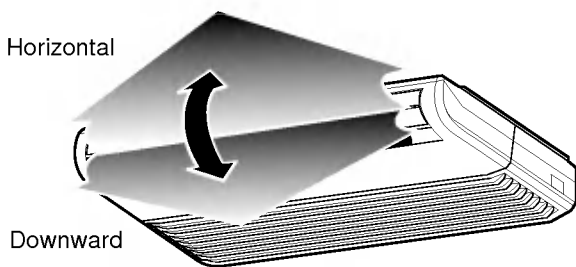

Caution

- Always use the remote controller to adjust the airflow direction. Manually moving the vertical airflow direction louver by hand could cause operation errors.
- When air conditioner operation is stopped, the vertical airflow direction louver will close the air outlet vent of room air conditioner.

1 Press the Start/Stop Button.
(Confirm the unit on operation.)



2 Press the Airflow Direction Control Button and the vertical louvers swing up and down automatically.

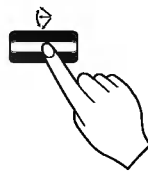

3 Press again the Airflow direction Control Button to set the vertical louver at the desired airflow direction.

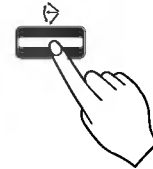

✓B Horizontal Airflow Direction Control

Manual Control

- Adjust the horizontal airflow direction by manually moving the horizontal airflow direction louver by hand.

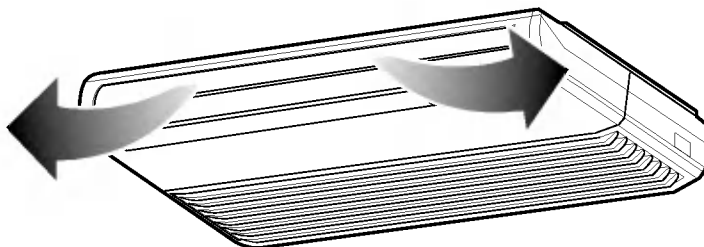

(5) Setting the Present Time

The present time can be set only when pressing the reset button or when replacing batteries for the remote controller.

- 1** Press the Start/Stop Button after pressing the RESET Button or changing batteries for Remote Controller.



- 2** Press the Time Setting Button until being set the desired time.

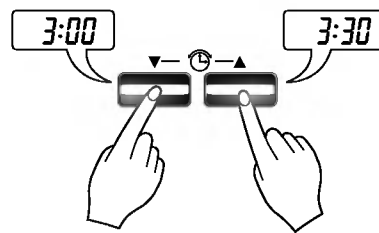

- 3** Press the Time SET Button.



NOTE : Check a.m. and p.m. Indicator in setting time.

(6) Timer Setting

(🕒 LED lamp ON)

Remote Control

- ✓A **ON Timer Button or OFF Timer Button**
- ✓B **Timer Setting Button**
- ✓C **Timer SET Button**
- ✓D **Timer CANCEL Button**

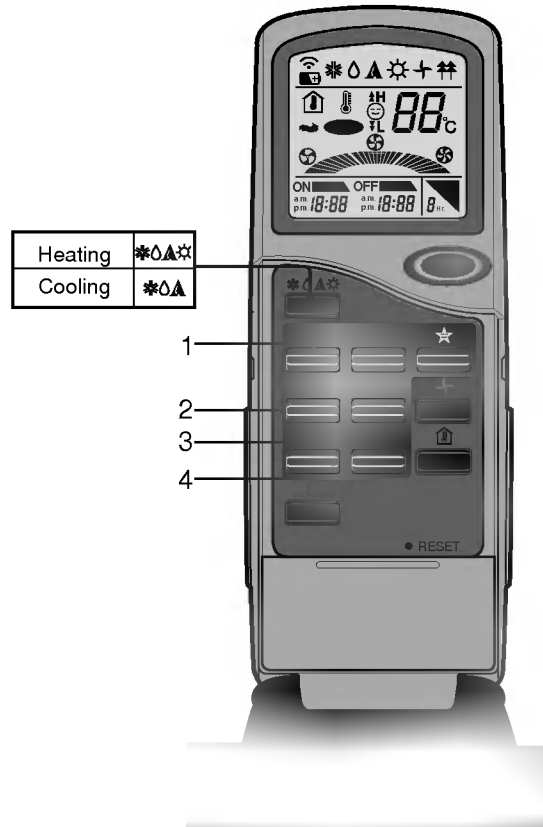

- 1** Press the ON Timer Button or OFF Timer Button.

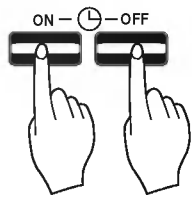

The timer setting will be displayed.

- 2** Change the Timer Setting and press the Timer Set Button.

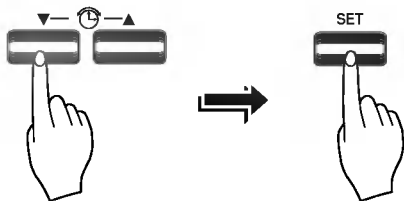

To cancel the settings

Press the Timer Cancel Button.



(The timer lamp on the air conditioner and the display will go out.)

If the settings are cancelled by a power failure.

Press the Start/Stop Button, and then set the timer again as desired time according to Timer Setting Procedure.

Timer Setting Procedure

1 Confirm the present time. (Refer to page 17)

2 Press On Timer Button or Off Timer Button.

- Select one of the following four types of operation.
- Each time the button is pressed, the operation mode is shifted to the arrow direction.

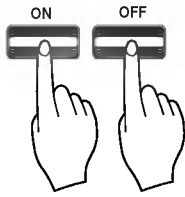

Delay
OFF Timer

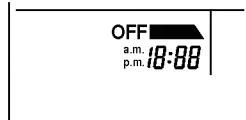

Operation stops at OFF Timer Setting.

Delay
ON Timer



Operation starts at ON Timer Setting.

Delay OFF
and ON Timer

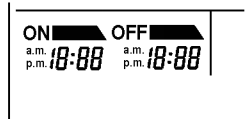

Operation stops at OFF Timer Setting and starts at ON Timer Setting.

Delay ON
and OFF
Timer

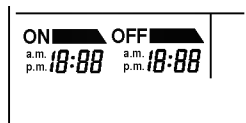

Operation starts at ON Timer Setting and stops at Off Timer Setting.

NOTE : Check a.m. and p.m. Indicator in setting time.

3 Press the Time Setting Button until being set the desired time.

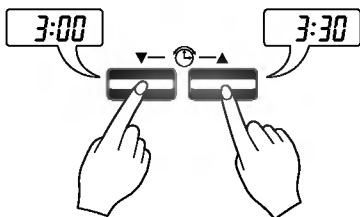

4 Press the Timer SET Button.



(7) Operation Details

• Soft Dry Operation Mode

When the room temp. is higher than the setting temperature, it operates cooling mode as the setting temperature, the setting fan speed (if CHAOS, then med.), and then it will be switched to Soft Dry Operation Mode when the room temperature reaches the setting temperature.

In Soft Dry Operation Mode, the indoor fan speed is automatically switched to low.

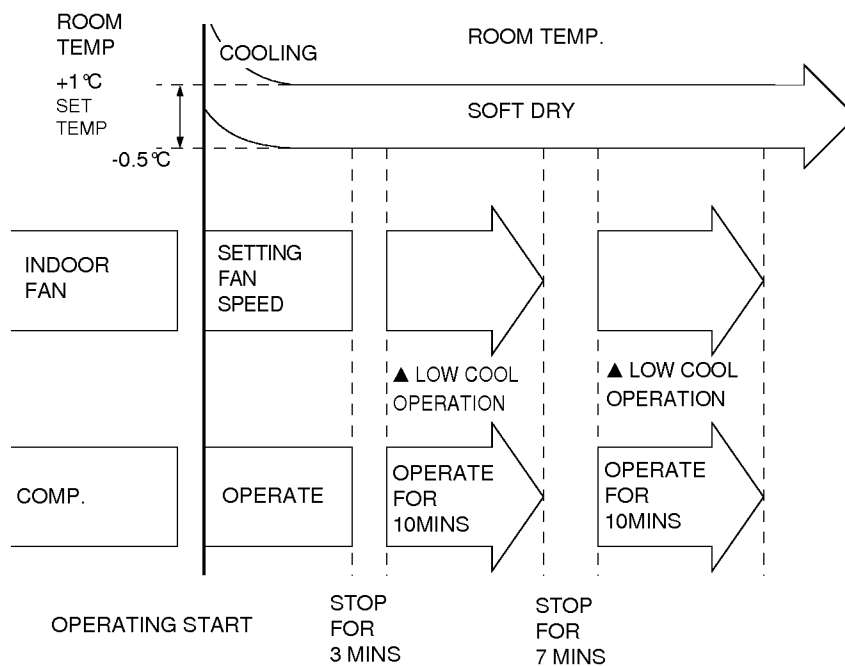

• Natural wind by the CHAOS logic



For more fresh feeling than other fan speed mode, press the indoor fan Speed Selector and set to CHAOS mode.

In this mode, the wind blows like natural breeze by automatically changing fan speed according to the CHAOS logic.

FORCED OPERATION

Operation procedures when the remote controller can't be used.

Press the Forced Operation Button.

If you want to stop operation, press again.

During Forced operation, the operating conditions are automatically set as the following.



Operating mode	Heating	Soft dry	Cooling
Setting temperature	22°C	Room temperature	24°C
Indoor fan speed	High	by soft dry rule	High

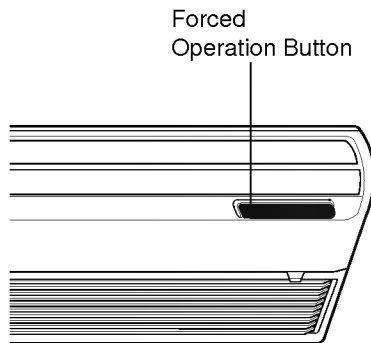

Press the Forced Operation Button.

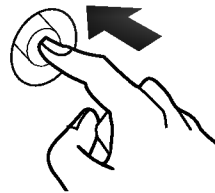

- Press the Forced Operation Button once again to stop operation.

Helpful information

Airflow speed and cooling capacity

The cooling capacity indicated in the specification is the value when the fan speed is set to high, and the capacity will be lower at low or medium fan speed.

High fan speed is recommended when you wish to cool the room quickly.

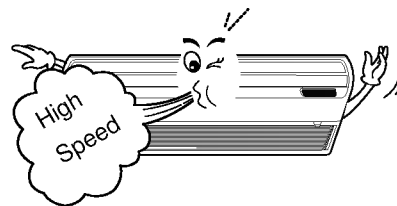

CARE AND MAINTENANCE

Before performing any maintenance procedure

Turn the main switch off.

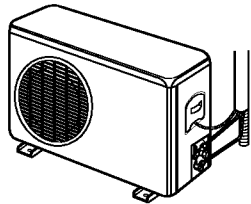

Main switch

Don't wash with water.



Never use any of the followings.

- Water hotter than 40°C.

Could cause deformation and/or discoloration.

- Volatile substances.

Could damage the surfaces of the air conditioner.

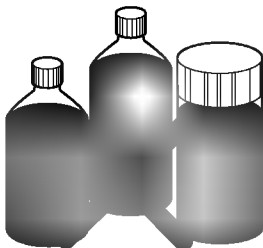

During the season

Cleaning of the air filters.

Recommended about once every two weeks.

- 1 Remove the Air Filters.
Take hold of the tab and pull slightly forward to remove the filter.

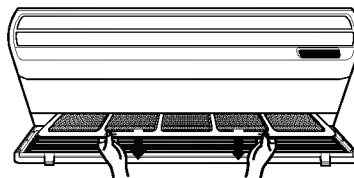

- 2 Clean.
To remove the dust adhered to the filters, either use a vacuum cleaner, or wash them in water and dry in the shade.
 - Re-insert the filter into the original position.

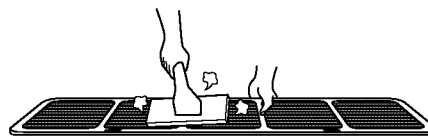

If the Air Filters become damaged.

- Purchase new filters from your air conditioner dealer.

Cleaning of the air conditioner and the remote controller.

- Wipe with a soft, dry cloth.

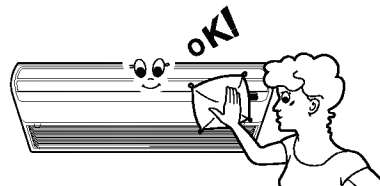

At the end of the season

- 1 Operate the air conditioner at the following settings for 2 to 3 hours.
 - Type of operation : Air circulation mode.(refer to page 11,12)

This will dry out the internal mechanisms.

- 2 Remove the batteries from the Remote Controller.

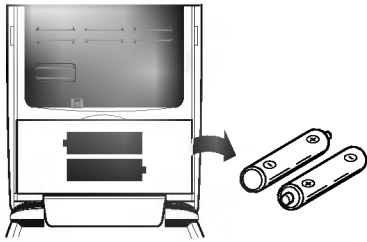

- 3 Cover the outdoor unit with the protective cover.



At the start of the season

- 1 Remove the protective cover from the outdoor unit.

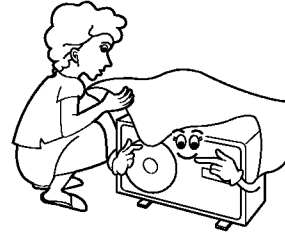

- 2 Clean the air filters, re-insert them, and operate the air conditioner.

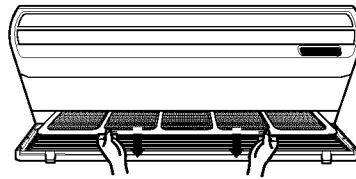

- 3 Be sure that nothing obstructs the air outlet and intake vents.

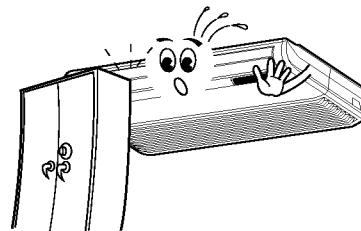

Helpful information

The air filters affect your electric bill. If the air filters become clogged with dust, the cooling capacity will drop, and 6% of the electricity used to operate the air conditioner will be wasted.

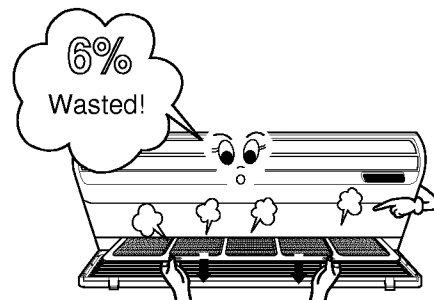

OPERATION TIPS

Do not overcool the room.

This is not good for the health and it wastes electricity.

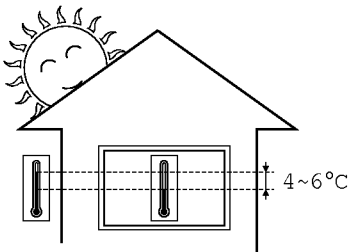

Keep blinds or curtains closed.

Do not let direct sunshine enter the room when the air conditioner is in operation.

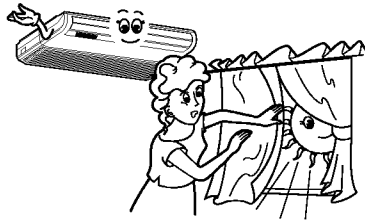

Keep the room temperature uniform.

Adjust the vertical and horizontal airflow direction to ensure a uniform temperature in the room.

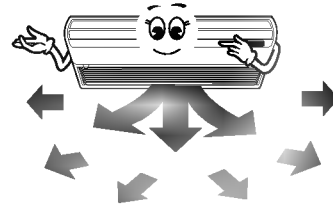

Make sure that the doors and windows are shut tight.

Avoid opening doors and windows as much as possible to keep the cool air in the room.

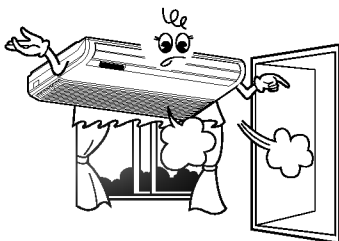

Clean the air filter regularly.

Blockages in the air filter reduce the airflow and lower cooling and dehumidifying effects. Clean at least once every two weeks.

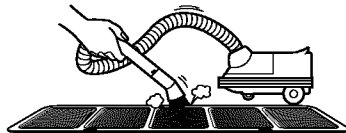

Ventilate the room occasionally.

Since windows are kept closed, it is a good idea to open them and ventilate the room now and then.

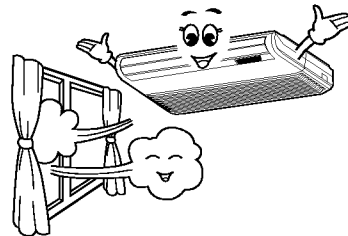

CAUTION

Please don't put the hand or stick in the indoor and outdoor unit.

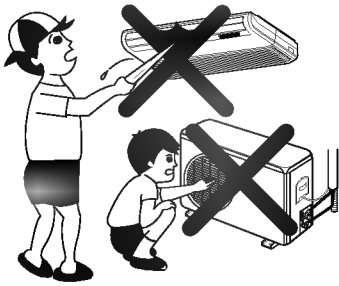

Do not use the air conditioner for purposes other than cooling or heating the room.

Do not use the air conditioner for other purposes, such as drying clothes, preserving foods, keeping animals, or cultivating vegetables.



Do not block the air intake and outlet vents.

This causes lowered performance and irregular operation. Do not insert sticks or other objects into these vents as it is dangerous to touch the electric components and the fan.

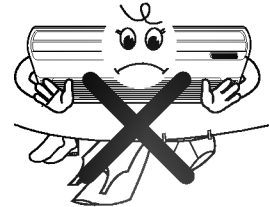

Select the most appropriate temperature.

Take care to adjust the temperature to suit the conditions. Rooms occupied by young infants, the elderly, or invalids should be kept at an appropriate temperature.

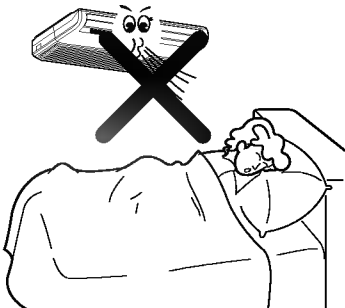

Do not use heating apparatus in the vicinity.

The air conditioner's plastic parts may melt if exposed to excessive heat.

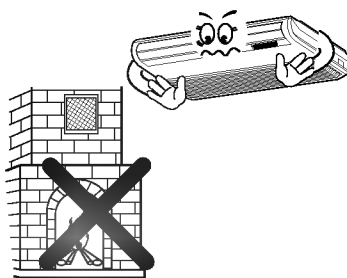

Avoid exposing the body directly to a continuous unidirectional cool airflow for long periods.

This is not good for your health.



BEFORE CALLING FOR SERVICE

Check the following points before requesting repairs or service.... If the malfunction persists, please contact your dealer.

Faults	Cause
Does not operate.	<ul style="list-style-type: none"> ⌘ Have you made a mistake in timer operation?
Does not cool or heat effectively.	<ul style="list-style-type: none"> ⌘ Is the air filter dirty? See air filter cleaning instructions. ⌘ The room may have been very hot when the room air conditioner was first turned on. Allow time for it to cool down. ⌘ Has the temperature been set incorrectly? ⌘ Are the indoor unit's air inlet or outlet vents obstructed?
The room has a peculiar odor.	<ul style="list-style-type: none"> ⌘ Check that this is not a damp smell exuded by the walls, carpet, furniture or cloth items in the room.
The air conditioner operation is noisy.	<ul style="list-style-type: none"> ⌘ For a noise that sounds like water flowing. <ul style="list-style-type: none"> -This is the sound of freon flowing inside the air conditioner unit. ⌘ For a noise that sounds like the compressed air releasing into atmosphere. <ul style="list-style-type: none"> -This is the sound of the dehumidifying water being processed inside the air conditioning unit.
It seems that condensation is leaking from the air conditioner.	<ul style="list-style-type: none"> ⌘ Condensation occurs when the airflow from the air conditioner cools the warm room air.
Air conditioner does not operate for about 3 minutes when restart.	<ul style="list-style-type: none"> ⌘ This is the protector of the mechanism. ⌘ Wait about three minutes and operation will begin.
Remote controller display is faint, or no display at all.	<ul style="list-style-type: none"> ⌘ Are the batteries depleted? ⌘ Are the batteries inserted in the opposite (+) and (-) directions?

NOTE

SPLASH PROOF : The outdoor side of this appliance is SPLASH PROOF, the indoor side is ordinary.

This is not malfunction

It may happen some noise the same as "Tig" "Tig" from the indoor unit when the unit operate or after the unit stop, which is due to the shrinkage or expansion of plastic body by temperature fluctuation.

