



REFRIGERATOR- FREEZER OWNER'S MANUAL

PLEASE
READ THIS OWNER'S MANUAL THOROUGHLY
BEFORE OPERATING AND KEEP IT HANDY FOR
REFERENCE AT ALL TIMES.



242, 282-3828JD8088W

CONTENTS

INSTALLATION	3
FEATURE CHART	4
OPERATION	6
Starting	
Temperature Control	
Ice Making	
Tray meat	
Defrosting	
SUGGESTIONS ON FOOD STORAGE	7
REPLACEMENT OF DOOR OPENING TYPE	8
Precaution	
How to Replace the Door Opening Type	
CLEANING	10
GENERAL INFORMATION	10
LAMP REPLACEMENT	11
IMPORTANT WARNINGS	11
BEFORE CALLING FOR SERVICE	12

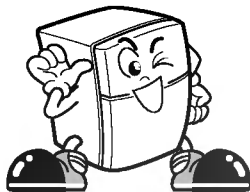

THIS REFRIGERATOR IS MANUFACTURED WITH GREAT CARE, AND UTILIZES THE LATEST IN TECHNOLOGY.

WE ARE CONFIDENT THAT YOU WILL BE FULLY SATISFIED WITH IT'S PERFORMANCE AND RELIABILITY.

BEFORE USING YOUR REFRIGERATOR, PLEASE READ THIS BOOKLET CAREFULLY. IT PROVIDES EXACT INSTRUCTIONS FOR INSTALLATION, OPERATION AND MAINTENANCE, AND ALSO SUPPLIES SOME USEFUL HINTS.

INSTALLATION

SELECT A GOOD LOCATION

1. Place your refrigerator where it is easy to use.
2. Avoid placing the refrigerator near heat sources, direct sunlight or moisture.
3. Air must circulate properly around your refrigerator to ensure efficient operation.
If your refrigerator is placed in a recessed area in the wall, allow at least 10 inch (25 cm) or greater clearance above the refrigerator and 2 inches (5 cm) or more from the wall.
The refrigerator should be elevated 1 inch (2.5 cm) from the floor, especially if it is carpeted.
4. To avoid vibrations, the refrigerator must be level.
If necessary, adjust the leveling screw(s) to compensate for unevenness of the floor.
To close the doors easily, the front should be slightly higher than the rear.
Leveling screw(s) can be turned easily by tipping the cabinet slightly.
Turn the leveling screw(s) clockwise to raise the refrigerator, counterclockwise to lower it.

NEXT

1. Wipe off all dust accumulated during shipping and clean your refrigerator thoroughly.
2. Install accessories such as the ice cube box, cover evaporating tray, etc., in their proper places. They are packed together to prevent possible damage during shipping.
3. Connect the power supply cord (or plug) to the outlet. Don't double up with other appliances on the same outlet.
4. Prior to use, let the refrigerator run for 2-3 hours.
Check the flow of cold air in the freezer compartment to ensure proper cooling has taken place.
Your refrigerator is now ready for use.

FEATURE CHART

☼ GR-242

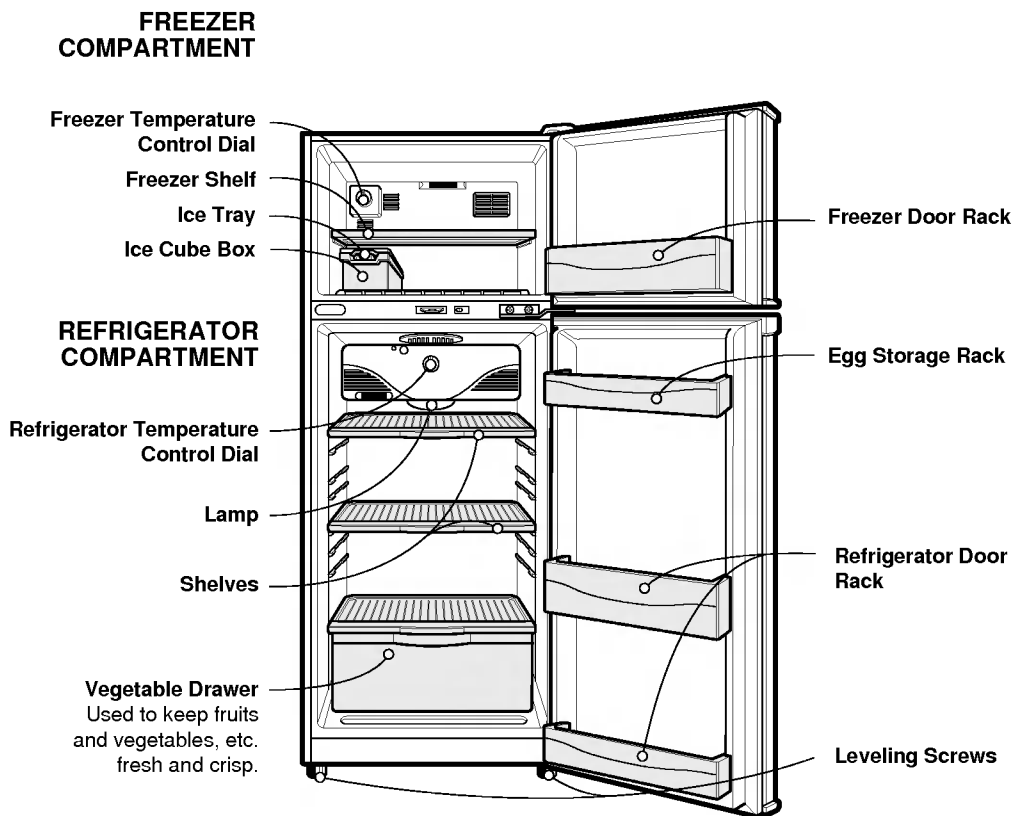

FEATURES CHART

☼ GR-282

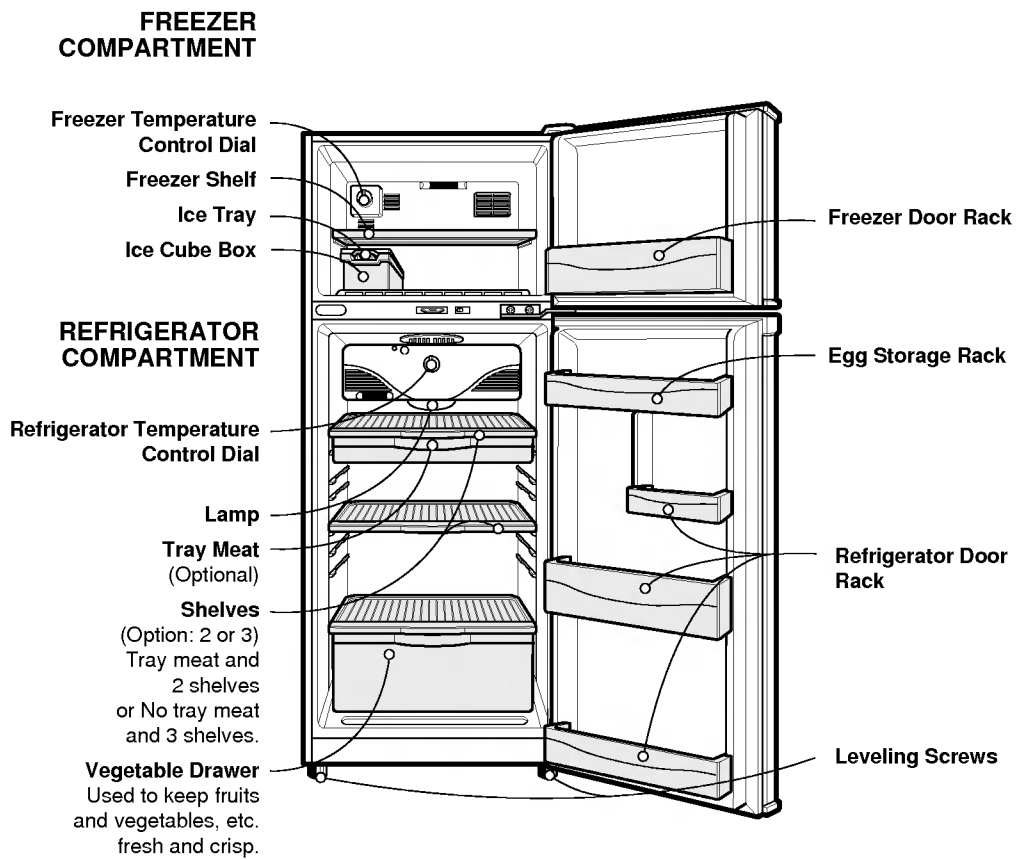

OPERATIONS

STARTING

When your refrigerator is first installed, allow it 2-3 hours to stabilize at normal operating temperatures prior to filling it with fresh or frozen foods.

If operation is interrupted, wait 5 minutes before restarting.

TEMPERATURE CONTROL

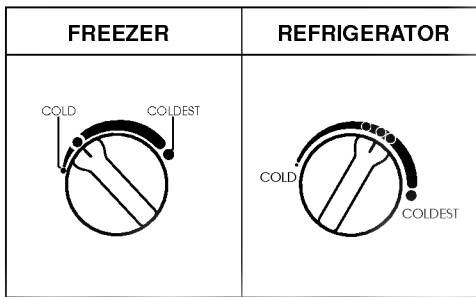

Your refrigerator has two dials that let you regulate the temperature in the freezer and refrigerator compartments.

Initially, dials are set at mid-point.

For colder temperatures, adjust each dial to "COLDEST", and for warmer temperatures, adjust each dial to "COLD" position.

ICE MAKING

- To make ice cubes, fill the ice tray with water and place it in the freezer.
- To remove ice cubes, hold the tray at its ends and twist gently.

 To remove ice cubes easily, run water on the tray before twisting.

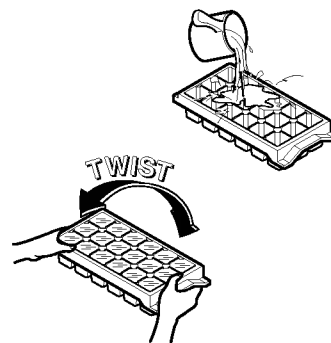

TRAY MEAT (optional)

- When the door is opened, the warmer air don't influence in the tray meat. So you can store food more fresh in it.
- The shelf and inserted tray meat must be placed at its position if it is moved, the tray meat can't fill the role of it.

DEFROSTING

Defrosting takes place automatically.

The defrosted water flows down to the evaporating tray which located in the lower back side of the refrigerator and is evaporated automatically.

SUGGESTIONS ON FOOD STORAGE

STORING FOOD

- Store fresh food in the refrigerator compartment. How food is frozen and thawed is an important factor in maintaining its freshness and flavor.
- Do not store food which goes bad easily at low temperatures, such as bananas, pineapples, and melons.
- Allow hot food to cool prior to storing. Placing hot food in the refrigerator could spoil other food, and lead to higher electric bills!
- When storing, cover food with vinyl wrap or store in a container with a lid. This prevents moisture from evaporating, and helps food to keep its taste and nutrients.
- Do not block air vents with food. Smooth circulation of chilled air keeps refrigerator temperatures even.
- Do not open the door frequently. Opening the door lets warm air enter the refrigerator, causing temperatures to rise.

FREEZER COMPARTMENT

- Do not store bottles in the freezer compartment - they may break when frozen.
- Do not refreeze food that has been thawed. This causes loss of taste and nutrition.
- When storing frozen food like ice cream for a long period, place it on the freezer shelf, not in the door rack.

REFRIGERATOR COMPARTMENT

- Avoid placing moist food deep inside refrigerator shelves, it could freeze upon direct contact with chilled air.
- Always clean food prior to refrigeration. Vegetables and fruits should be washed and wiped, and packed food should be wiped clean, to prevent adjacent food from spoiling.
- When storing eggs in their storage rack, ensure that they are fresh, and always store them in a up-right position, which keeps them fresh longer.

REPLACEMENT OF DOOR OPENING TYPE

- Converting Door is Optional

PRECAUTION

1. Before replacing the door opening type, first of all, you should take out foodstuffs and accessories like shelves or trays, and so on which are not fixed in the refrigerator.
2. Use the '+' Driver, Bolt Driver, Torque Wrench or Spanner to fix or remove the bolt.
3. Be careful not to fall down the refrigerator in disassembling or assembling the Hinge Lower and the Adjustable Screw Asm. Don't lay the refrigerator down in working with it, it will cause to get out of order.
4. Be careful not to drop the door in disassembling or assembling the freezer or the refrigerator door.
5. This refrigerator, according to the install position or user's liking, can be used as the type of opening from the right or the left.

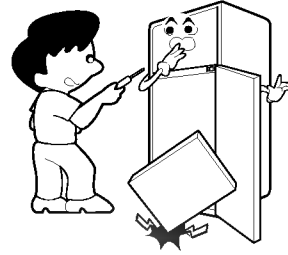

HOW TO REPLACE THE DOOR OPENING TYPE (when converting from the left-opening type to right opening type)

1 Separate the Cap 1 and Hinge Upper 2.

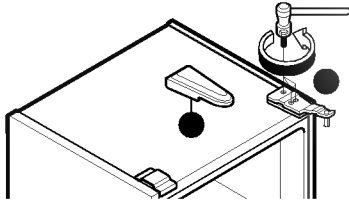

2 Separating the Freezer Door 3.

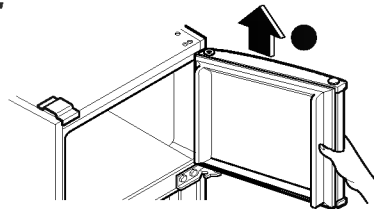

3 Separating the Hinge-C 4 and the Refrigerator Door 5.

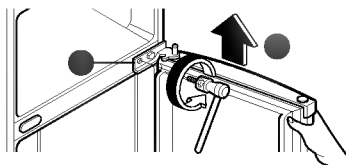

4 Separating the Hinge Lower 6.

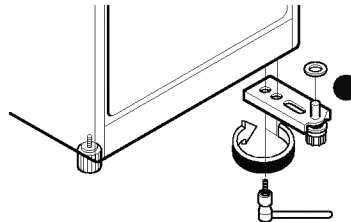

REPLACEMENT OF DOOR OPENING TYPE

5 Move the Position of Adjustable Screw Assembly 7.

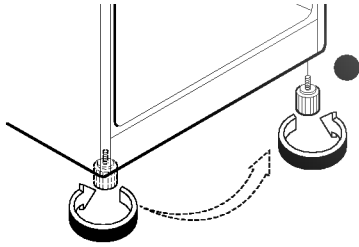

6 Assemble the Hinge Lower 6.

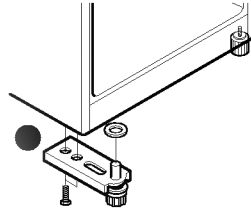

7 Move the Cap 8, Bracket 9 of the Refrigerator Door.

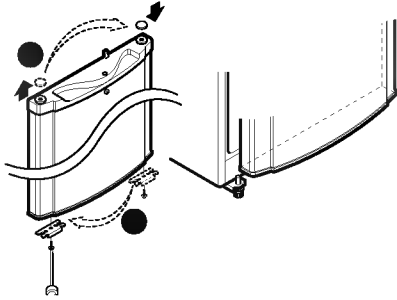

8 Move the Cap 10 and Assemble the Hinge-C 4.

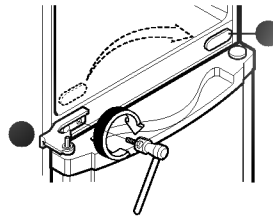

9 Assemble the Door Stopper-F 11 for Right Opening Type.

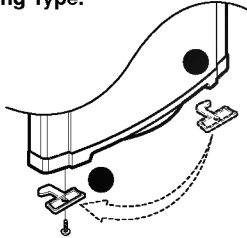

10 Move the Cap 12 and Assemble the Freezer Door 3.

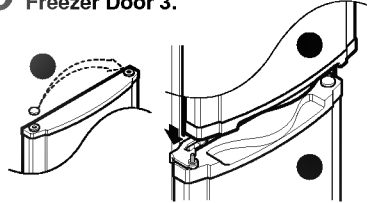

11 Move the Pin Position 13 of the Hinge Upper.

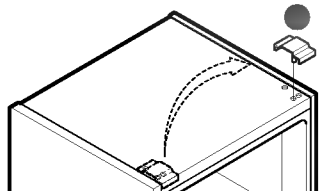

12 Assemble the Hinge Upper 2 and the Cap 1.

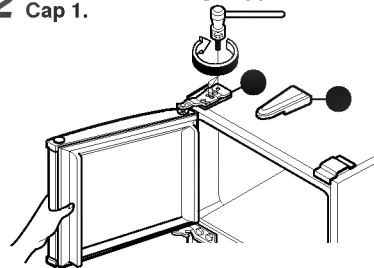

CLEANING

It is important that your refrigerator be kept clean to prevent undesirable odors. Spilled food should be wiped up immediately, since it may acidify and stain plastic surfaces if allowed to settle.

Never use metallic scouring pads, brushes, coarse abrasive cleaners or strong alkaline solutions on any surface.

Before you clean, however, remember that damp objects will stick or adhere to extremely cold surfaces. Do not touch frozen surfaces with wet or damp hands.

EXTERIOR - Use a lukewarm solution of mild soap or detergent to clean the durable finish of your refrigerator. Wipe with a clean, damp cloth and then dry.

INTERIOR - Regular cleaning of the interior and interior parts is recommended. If you have the No Frost model which defrosts automatically, leave both doors open during the entire cleaning process. Disconnect the power supply, and remove food and all compartment shelves, storage trays etc. Wash all compartments with a baking soda solution. Rinse and dry.

INTERIOR PARTS - Wash compartment shelves, door racks, storage trays and magnetic door seals etc. with the baking soda solution or a mild detergent and warm water. Rinse and dry.

WARNING

Always remove power cord from the wall outlet prior to cleaning in the vicinity of electrical parts (lamps, switches, controls, etc.). Wipe up excess moisture with a sponge or cloth to prevent water or liquid from getting into any electrical part and causing a electric shock. Do not use flammable or toxic cleaning liquids.

GENERAL INFORMATION

VACATION TIME

During average length vacations, you will probably find it best to leave the refrigerator in operation. Place freezable items in freezer for longer life. When you plan to be away for an extended period, remove all food, disconnect the power cord, clean the interior thoroughly, and leave each door OPEN to prevent odor formation.

POWER FAILURE

Most power failures are corrected in an hour or two and will not affect your refrigerator temperatures. However, you should minimize the number of door openings while the power is off. During power failures of longer duration, place a block of dry ice on top of your frozen packages.

IF YOU MOVE

Remove or securely fasten down all loose items inside the refrigerator. To avoid damaging the leveling screw(s), turn them all the way into the base.

ANTI-CONDENSATION PIPE

The outside wall of the refrigerator cabinet may sometimes get warm, especially just after installation.

Don't be alarmed.

This is due to the anti-condensation pipe, which pumps hot refrigerant to prevent "sweating" on the outer cabinet wall.

Anti-Condensation Pipe

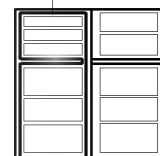

LAMP REPLACEMENT

1. Unplug the power cord from the outlet.
2. Remove refrigerator shelves.
3. Remove the lamp by turning it counterclockwise as shown in the figure at right.
4. Assemble in reverse order of disassembly. Replacement bulb must be the same specification as original.

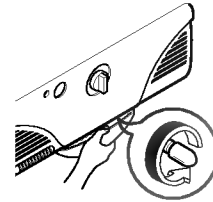

IMPORTANT WARNINGS

DO NOT USE AN EXTENSION CORD

If possible, connect the refrigerator to its own individual electrical outlet to prevent it and other appliances or household lights from causing an overload that could cause a power outage.

POWER CORD REPLACEMENT

If the supply cord is damaged, it must be replaced by a special cord or assembly available from manufacturer or its service agent.

ABOUT GROUNDING (EARTHING)

In the event of an electric short circuit, grounding (earthing) reduces the risk of electric shock by providing an escape wire for the electric current.

In order to prevent possible electric shock, this appliance must be grounded.

Improper use of the grounding plug can result in an electric shock. Consult a qualified electrician or service person if the grounding instructions are not completely understood, or if you have doubts on whether the appliance is properly grounded.

VERY DANGEROUS ATTRACTION

An empty refrigerator can be a dangerous attraction to children. Remove either gaskets, latches, lids or the entire door from your unused appliance, or take some other action to make it harmless.

This appliance must be grounded (earthed).

DON'T WAIT! DO IT NOW!

Do not store inflammable materials, explosives or chemicals in the refrigerator.

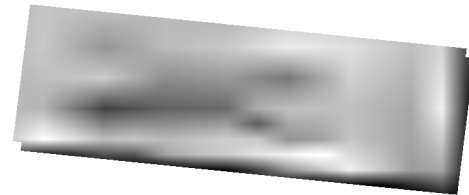

SERVICE CALLS CAN OFTEN BE AVOIDED!
IF YOU FEEL YOUR REFRIGERATOR IS NOT OPERATING PROPERLY, CHECK THESE POSSIBLE CAUSES FIRST :

PROBLEM	POSSIBLE CAUSES
REFRIGERATOR DOES NOT OPERATE	<ul style="list-style-type: none">● Has a house fuse blown or circuit breaker tripped?● Has the power cord plug been removed or loosened from the electrical wall outlet?
REFRIGERATOR OR FREEZER COMPARTMENT TEMPERATURE TOO WARM	<ul style="list-style-type: none">● Temperature control not set on proper position.● Appliance is placed close to wall or heat source.● Warm weather-frequent door openings.● Door left open for a long time.● Large amount of foods are kept in the refrigerator.
ABNORMAL NOISE(S)	<ul style="list-style-type: none">● Refrigerator is installed in a weak or uneven place, or leveling screw needs adjusting.● Unnecessary objects placed in the back side of the refrigerator.
REFRIGERATOR HAS ODOR	<ul style="list-style-type: none">● Foods with strong odors should be tightly covered or wrapped.● Interior needs cleaning.
DEW FORMS ON THE CABINET SURFACE	<ul style="list-style-type: none">● Not unusual during periods of high humidity.● Door may have been left ajar.