

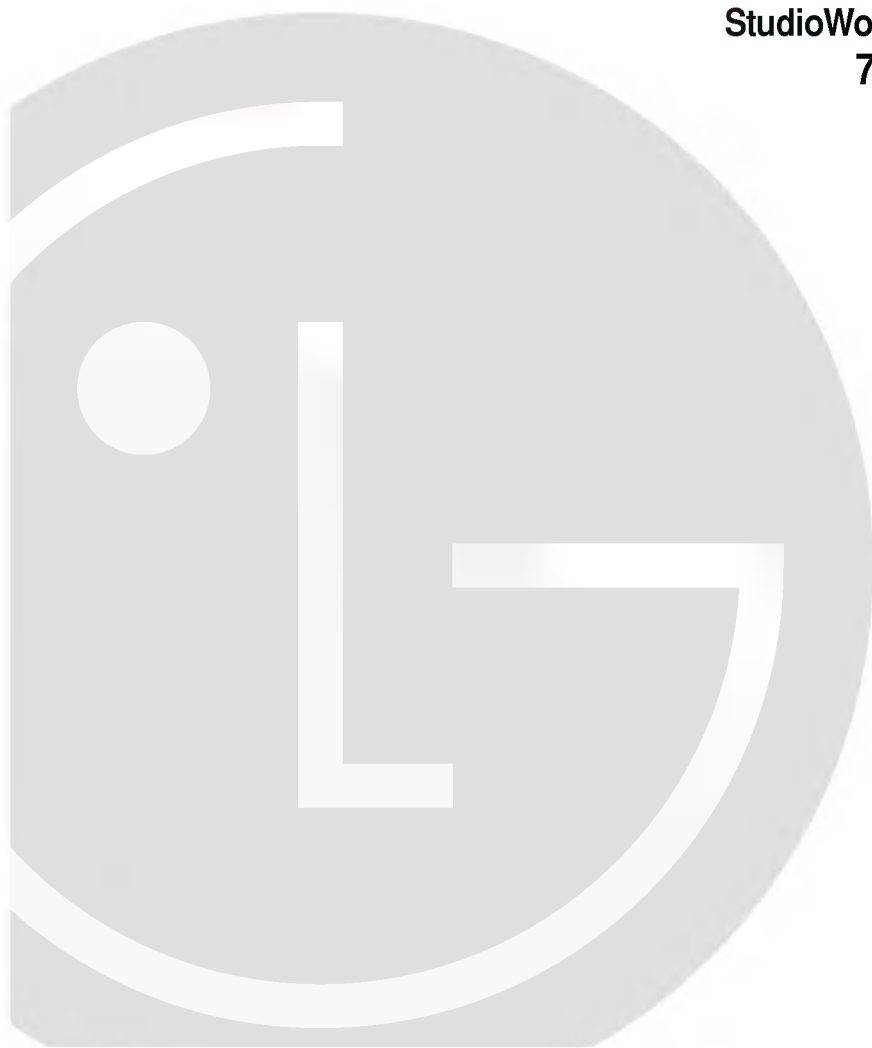

# Color Monitor

**USER GUIDE**  
**GUIA DEL USUARIO**

**StudioWorks**  
**77S**



## **FCC Compliance Statement**

---

This equipment has been tested and found to comply with the limits for a Class B digital device pursuant to Part 15 of the FCC Rules. These limits are designed to provide reasonable protection against harmful interference in a residential installation.

This equipment generates, uses, and can radiate radio frequency energy and if not installed and used in accordance with the instructions, may cause harmful interference to radio communications. However, there is no guarantee that interference will not occur in a particular installation.

If this equipment does cause harmful interference to radio or television reception (which can be determined by turning the equipment off and on), the user is encouraged to try to correct the interference by using one or more of the following measures:

- Reorient or relocate the receiving antenna.
- Increase the separation between the equipment and the receiver.
- Connect the equipment into an outlet on a circuit different from that to which the receiver is connected.
- Consult the dealer or an experienced radio/TV technician for help.

**Caution:** Changes or modifications not expressly approved by LG Electronics Inc. for compliance could void the user's (or your) authority to operate the equipment. Only peripherals (digital input/output devices, terminals, printers, etc.) certified to comply with the Class B limits may be attached to this monitor. Operation with non-certified peripherals is likely to result in interference to radio and TV reception.

Only shielded Signal Cables may be used with this System.

### **Canadian D. O. C. Notice**

This Class B digital apparatus meets all requirements of the Canadian Interference-Causing Equipment Regulations.

Cet appareil numérique de la classe B respecte toutes les exigences du Règlement sur le matériel brouilleur du Canada.



## Table of Contents

---

<b>Introduction</b>	
Features .....	A1
<b>Monitor Registration</b>	
Notice.....	A2
Trademark Acknowledgments .....	A2
<b>Important Precautions</b>	
On Safety .....	A3
On Installation .....	A4
On Cleaning .....	A4
On Repacking .....	A4
<b>Connecting the monitor</b>	
Connecting to any IBM VGA PC Compatible System.....	A6
Connecting to an Apple Macintosh II, Centris and Quadra.....	A7
<b>Location and Function of Controls</b>	
Front View .....	A8
Rear View .....	A8
<b>Control Panel Function</b>	
Front Panel Controls .....	A9
Left Side Jacks.....	A10
Rear Panel Jacks.....	A10
Microphone Operation .....	A10
Audio Features.....	A10
<b>On Screen Display (OSD) Control Adjustment</b> .....	A11
<b>On Screen Display (OSD) Selection and Adjustment</b> .....	A12
<b>Sound Selection and Adjustment</b> .....	A16
<b>Video Memory Modes</b>	
Factory Preset Timing Signal Chart.....	A17
User Modes.....	A18
Recalling Display Modes.....	A18
<b>Energy Saving Design</b>	
Power Consumption.....	A19
<b>MPR II, Self Diagnostics, DDC and Ultra-Contrast</b>	
Low Radiation Compliance (MPR II).....	A20
Self Diagnostics .....	A20
DDC (Display Data Channel) .....	A20
Why LGE'S Ultra-Contrast ? .....	A21
<b>Troubleshooting Tips and Service</b>	
Troubleshooting .....	A22
Service .....	A23
<b>Specifications</b>	
Specifications .....	A24

## Introduction

---

Thank you for purchasing a high resolution monitor. It will give you high resolution performance and convenient reliable operation in a variety of video operating modes.

### Features

- The monitor is a 17 inches (15.9 inches viewable ) intelligent, microprocessor based monitor compatible with most analog RGB (Red, Green, Blue) display standards, including IBM PC®, PS/2®, Apple®, Macintosh®, Centris®, Quadra®, and Macintosh II family.
- The monitor provides crisp text and vivid color graphics with VGA, SVGA, XGA, and VESA Ergo modes (non-interlaced), and most Macintosh compatible color video cards when used with the appropriate adaptor. The monitor's wide compatibility makes it possible to upgrade video cards or software without purchasing a new monitor.
- Digitally controlled auto-scanning is done with the microprocessor for horizontal scan frequencies between 30 and 70kHz, and vertical scan frequencies between 50 and 160Hz. The microprocessor-based intelligence allows the monitor to operate in each frequency mode with the precision of a fixed frequency monitor.
- The microprocessor-based digital controls allow you to adjust conveniently a variety of image controls by using the OSD (On Screen Display).
- The monitor has 32 memory locations for display modes, 7 of which are factory preset to popular video modes.
- This monitor is capable of producing a maximum horizontal resolution of 1280 dots and a maximum vertical resolution of 1024 lines. It is well suited for CAD work and sophisticated windowing environments.
- For greater user health and safety, this monitor complies with the stringent Swedish TCO'95 requirements for low radiation emissions.
- For low cost of monitor operation, this monitor is certified as meeting the EPA Energy Star requirements, and utilizes the VESA Display Power Management Signalling (DPMS) protocol for power saving during non-use periods.

## Monitor Registration

---

The model and serial numbers are found on the rear of this unit. These numbers are unique to this unit and not available to others. You should record requested information here and retain this guide as a permanent record of your purchase. Staple your receipt here.

Date of Purchase : \_\_\_\_\_  
Dealer Purchased From : \_\_\_\_\_  
Dealer Address : \_\_\_\_\_  
Dealer Phone No. : \_\_\_\_\_  
Model No. : \_\_\_\_\_  
Serial No. : \_\_\_\_\_

### Notice

All rights reserved. Reproduction in any manner, in whole or in part, is strictly prohibited without the written permission of LG Electronics Inc.

### Trademark Acknowledgments

**LG** is a trademark of **LG Electronics Inc.**

**IBM** is a registered trademark and **VGA** is a trademark of International Business Machines Corporation.

---

**Warning :** To reduce the risk of fire or electric shock, do not expose this appliance to rain or moisture.

**Avertissement :** Ne pas placer cet appareil dans un endroit humide. Cela peut entraîner un incendie ou une décharge électrique.

## Important Precautions

---

This unit has been engineered and manufactured to assure your personal safety, but improper use can result in potential electrical shock or fire hazard. In order not to defeat the safeguards incorporated in this monitor, observe the following basic rules for its installation, use, and servicing. Also follow all warnings and instructions marked directly on your monitor.

### On Safety

---

Use only the power cord supplied with the unit. In case you use another power cord, make sure that it is certified by the applicable standards (UL/CSA or VDE) if not being provided by the supplier.

Operate the monitor only from a power source indicated in the specifications of this manual or listed on the monitor. If you are not sure what type of power supply you have in your home, consult with your dealer.

Overloaded AC outlets and extension cords are dangerous. So are frayed power cords and broken plugs. They may result in a shock or fire hazard. Call your service technician for replacement.

### Do not Open the Monitor

- There are no user serviceable components inside.
- There are Dangerous High Voltages inside, even when the power is OFF.
- Contact your dealer if the monitor is not operating properly.

### To Avoid Personal Injury :

- Do not place the monitor on a sloping shelf unless properly secured.
- Use only a stand recommended by the manufacturer.
- Do not try to roll a stand with small casters across thresholds or deep pile carpets.

### To Prevent Fire or Hazards:

- Always turn the monitor OFF if you leave the room for more than a short period of time. Never leave the monitor ON when leaving the house.
- Keep children from dropping or pushing objects into the monitor's cabinet openings. Some internal parts carry hazardous voltages.

- 
- Do not add accessories that have not been designed for this monitor.
  - During a lightning storm or when the monitor is to be left unattended for an extended period of time, unplug it from the wall outlet.
  - Do not bring magnetic devices such as magnets or motors near the picture tube.
- 

### **On Installation**

---

Do not allow anything to rest upon or roll over the power cord, and do not place the monitor where the power cord is subject to damage.

---

Do not use this monitor near water such as near a bathtub, washbowl, kitchen sink, laundry tub, in a wet basement, or near a swimming pool.

---

Monitors are provided with ventilation openings in the cabinet to allow the release of heat generated during operation. If these openings are blocked, built-up heat can cause failures which may result in a fire hazard. Therefore, NEVER:

- Block the bottom ventilation slots by placing the monitor on a bed, sofa, rug, etc.
  - Place the monitor in a built-in enclosure unless proper ventilation is provided.
  - Cover the openings with cloth or other material.
  - Place the monitor near or over a radiator or heat source.
- 

### **On Cleaning**

---

- Unplug the monitor before cleaning the face of the picture tube.
  - Use a slightly damp (not wet) cloth. Do not use an aerosol directly on the picture tube because overspray may cause electrical shock.
- 

### **On Repacking**

---

- Do not throw away the carton and packing materials. They make an ideal container in which to transport the unit. When shipping the unit to another location, repack it in its original material.
-

## **Connecting the Monitor**

---

On the back of the monitor are two plug-in connections; one for the AC power cord, and the others for the signal cable from the video card.

### **AC Power Connection**

One end of the AC power cord is connected into the AC power connector on the back of the monitor. The other end is plugged into a properly grounded three-prong AC outlet. The monitor's auto-sensing power supply can automatically detect 100-120V AC or 200-240V AC, 50 or 60Hz.

### **Signal Cable Connection**

The connector for the signal cable is located on the back of the monitor. The 15 pin VGA connectors on the back of the monitor allow for a wide variety of video controllers to be connected to the monitor. Examples of signals that might be sent to the monitor include signals from IBM PC and compatibles, Apple Macintosh, Centris and Quadra.

The supplied signal cable consists of 15 pin VGA connectors at both ends, suitable for connections to an IBM PC or compatible.

Other generic cables or adapters may be used for connections to your equipment, as long as they meet the compatible signal requirements to activate this monitor (see page A24 for input specifications). For Apple Macintosh use, a separate plug adapter is needed to change the 15 pin high density (3 row) D-sub VGA connector on the supplied cable to a 15 pin 2 row connector. Examples of typical connections are shown below. Select the connection example that fits your needs.



---

### Connecting to any IBM VGA PC compatible system

Figure 3 shows the signal cable connections from the monitor to the Video Graphics Array (VGA) port typical in an IBM PC or PC compatible. This also applies to any graphics video card for PC-CAD or workstation that has a 15 pin high density (3 row) D-Sub connector.

1. Power off both the monitor and PC.
2. Connect the 15 pin VGA connector of the supplied signal cable to the output VGA video connector on the PC and the matching input connector on the rear of the monitor. The connectors will mate only one way. If you cannot attach the cable easily, turn the connector upside down and try again. When mated, tighten the thumbscrews to secure the connection.
3. Power ON the PC, then the monitor.
4. If you see the **NO SIGNAL** message, check the signal cable and connectors.
5. After using the system, power OFF the monitor, then the PC.

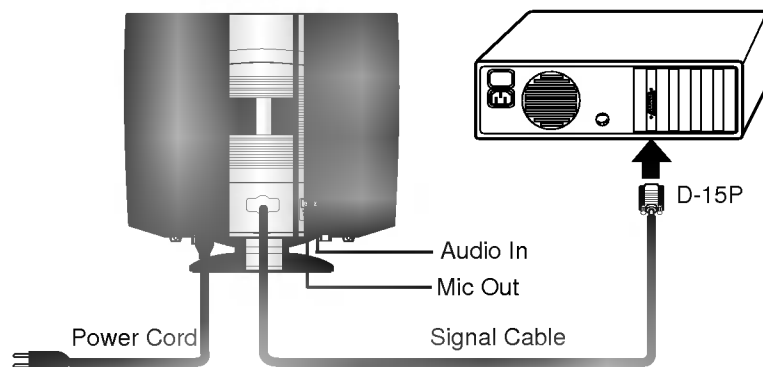

Figure 3.

---

## Connecting to an Apple Macintosh II, Centris and Quadra

Figure 4 shows the connection to an Apple Macintosh, using a separately purchased adapter.

1. Power OFF both the monitor and the PC.
2. Locate the appropriate MAC to VGA adapter block at your local computer store. This adapter changes the high density 3 row 15 pin VGA connector to the correct 15 pin 2 row connection to mate with your MAC. Attach the other end of the signal cable to the side of the adapter block with 3 rows.
3. Connect the attached adapter block/signal cable to the video output on your MAC.
4. Power ON the PC, then the monitor.
5. If you see the **NO SIGNAL** message, check the signal cable and connectors.
6. After using the system, power OFF the monitor, then the PC.

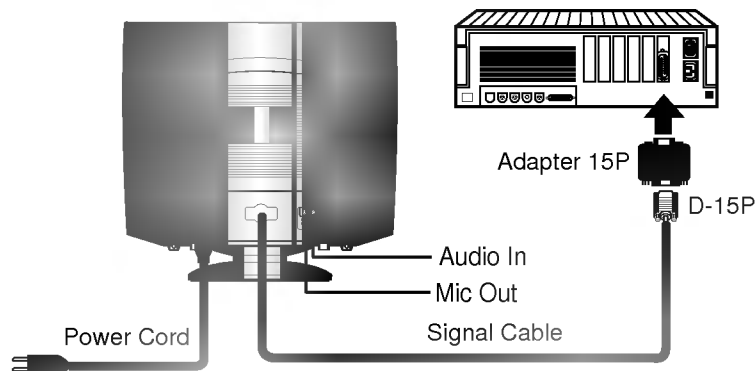
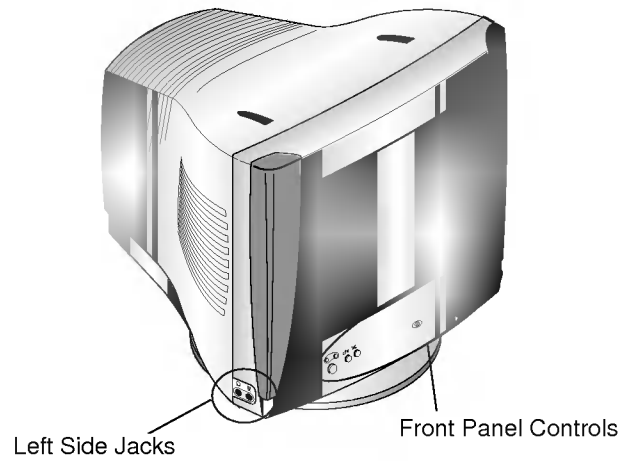

Figure 4.

## Location and Function of Controls

---

### Front View





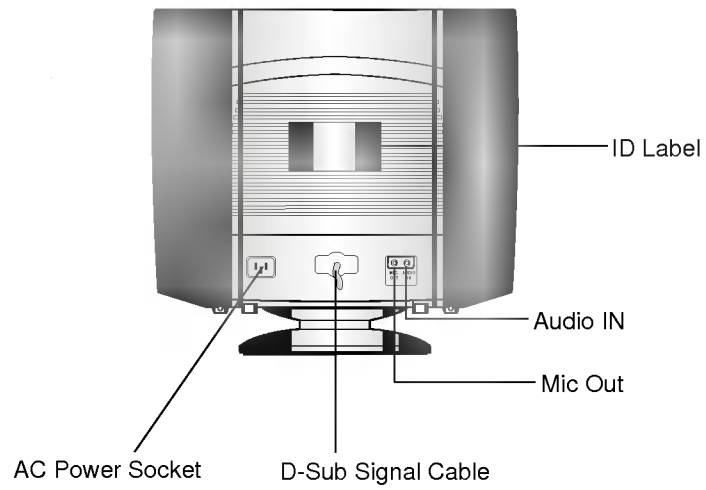





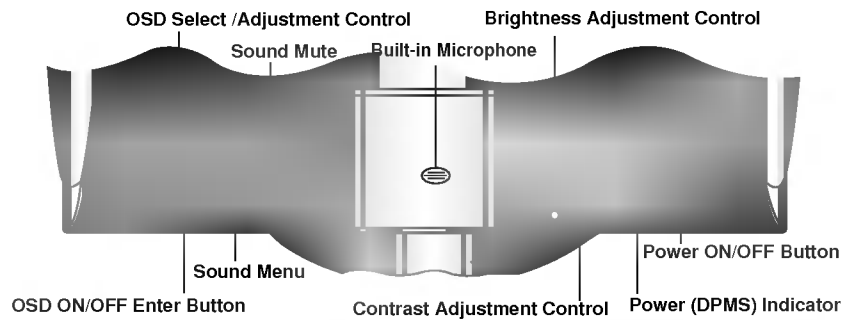

### Rear View



## Control Panel Function

### Front Panel Controls





Control	Function
 <b>OSD Select/ Adjustment Control</b>	Use this buttons selecting (highlighting) an OSD icon to be adjusted. It is also used for selecting the level of the selected item to be adjusted.
 <b>OSD ON/OFF Enter Button</b>	Use this button to start/enter and exit from the On Screen Display.
 <b>Sound Menu</b>	To adjust sound menu.
 <b>Sound Mute</b>	Used to select mute on (means sound off) and mute off (means sound on).
 <b>Built-in Microphone</b>	Built-in Microphone.
 <b>Brightness Adjustment Control</b>	Used to adjust the brightness of the screen.
 <b>Contrast Adjustment Control</b>	Adjust the display to the contrast desired.
 <b>Power (DPMS) Indicator</b>	This Indicator lights up green when the monitor operates normally. If the monitor is in DPM (Energy Saving) mode (stand-by/suspend/power off), this indicator color changes to amber.
 <b>Power ON/OFF Button</b>	Use this button to turn the monitor on or off.

---

## Left Side Jacks

---

	<b>Headphone Jack</b> 	Headphone Jack that automatically mutes the speaker volume when headphone is attached.
	<b>Microphone Jack</b> 	An external microphone can be used instead of the built-in microphone.

---

## Rear Panel Jacks

---

	<b>Mic. Out</b>	Connects microphone sound to PC via cable.
	<b>Audio In</b>	Connects speaker sound to PC via cable attachment.

---

### Microphone Operation

On the left side there is a MIC (Microphone) jack. By plugging a microphone in here, it may reduce the long length of cable needed to reach the PC's sound card. In order to use this MIC jack, you need to use a cable (supplied) to plug into the rear of the monitor (MIC OUT) and into the MIC input jack of your sound card (if available).



### Audio Features

A major feature of this monitor is its built-in audio system. This conveniently integrates a stereo audio amplifier and speakers without taking up any more space. Because the monitor is designed like this, you can easily upgrade to audio capable multimedia applications by attaching your PC with sound card to the back of this monitor. It will result in significantly less cabling and space requirements.

## On Screen Display (OSD) Control Adjustment

Making adjustments to the image size, position, and operating parameters of the monitor is quick and easy with the On Screen Display Control system, using only the ENTER button and Adjustment Control buttons. A quick example is given below to familiarize you with the use of the controls. Following this section is an outline of the available adjustments and selections you can make using the OSD.

**Note :** (Monitor and PC should be ON, with an image or prompt on the screen). A single press of the ENTER button will present you with the Main Menu of the on screen display system with the first (  ) highlighted.

The main picture area will also show the select icon (  ) and next icon (  ).

1. The OSD system should look like:



2. To adjust H Position (  ), Press the enter button once.  
The display will look like:



When you are done, Press the main button (  ) once to return to main menu to make another selection.













3. You want to move the next icon, Adjust the next button (  ) control.  
The display will look like:













## On Screen Display(OSD) Selection and Adjustment

You were introduced to the procedure of selection and adjusting an item using the OSD system.



Listed below are the icons, icon names, and icon descriptions of the items that are shown on the Menu.

OSD Adjust	Description
 <b>Horizontal Position</b> 	To move picture image left and right. <ul style="list-style-type: none"><li>◀ Moves the screen image left.</li><li>▶ Moves the screen image right.</li></ul>
 <b>Horizontal Size</b> 	To adjust image width. <ul style="list-style-type: none"><li>◀ Decreases the size of the screen image.</li><li>▶ Increases the size of the screen image.</li></ul>
 <b>Vertical Position</b> 	To move image up and down. <ul style="list-style-type: none"><li>◀ Moves the screen image up.</li><li>▶ Moves the screen image down.</li></ul>
 <b>Vertical Size</b> 	To adjust image height. <ul style="list-style-type: none"><li>◀ Decreases the size of the screen image.</li><li>▶ Increases the size of the screen image.</li></ul>
 <b>Side Pincushion</b> 	To correct the bowing in and out of the image. <ul style="list-style-type: none"><li>◀ Curves the image's edges inwards.</li><li>▶ Curves the image's edges outwards.</li></ul>
 <b>Trapezoid</b> 	To correct geometric distortion. <ul style="list-style-type: none"><li>◀ Makes the screen image narrower at the top.</li><li>▶ Moves the screen image wider at the top.</li></ul>



OSD Adjust	Description
<p data-bbox="386 600 687 629">  <b>Side pincushion balance</b> </p> 	<p data-bbox="756 622 1198 651">To correct the balance of both sides bowling.</p> <ul data-bbox="783 651 1166 707" style="list-style-type: none"> <li>◀ Curvature of the sides to the right.</li> <li>▶ Curvature of the sides to the left.</li> </ul>
<p data-bbox="386 768 576 797">  <b>Parallelogram</b> </p> 	<p data-bbox="756 790 1182 846">This control adjusts for a skewing of the screen image.</p> <ul data-bbox="783 846 1166 902" style="list-style-type: none"> <li>◀ Tilts the screen image rightward.</li> <li>▶ Tilts the screen image leftward.</li> </ul>
<p data-bbox="386 925 464 954">  <b>Tilt</b> </p> 	<p data-bbox="756 947 1023 976">To correct image rotation.</p> <ul data-bbox="783 976 1102 1032" style="list-style-type: none"> <li>◀ Tilts the screen image left.</li> <li>▶ Tilts the screen image right.</li> </ul>
<p data-bbox="386 1081 600 1111">  <b>Moire Reduction</b> </p>  	<p data-bbox="756 1115 1198 1227">This item allows you to reduce the moire. It is normally <b>OFF</b>. If you want to adjust it, select <b>ON</b> using the adjustment control and push the Enter Button.</p> <p data-bbox="756 1261 1198 1406"><b>NOTE :</b> The screen image may shake slightly while the moire reduction function is <b>ON</b>. Switching the <b>OFF</b> will improve image stability and clarity at the expense of slightly greater moire.</p>
<p data-bbox="386 1429 616 1458">  <b>Video Input Level</b> </p> 	<p data-bbox="756 1451 1198 1541">This item is used to select the monitor's input signal level. The normal level used for most PC's is 0.7V.</p>









OSD Adjust	Description
------------	-------------

<p><b>OSD Color Select</b></p>   	<p>To select color temperature 9300K/ 6550K/ USER and CURVE. Select the desired color temperature or select user to set your own color levels.</p> <p>Allow for specific adjustments to Red, Green and Blue(R/G/B).</p> <ul style="list-style-type: none"> <li>◀ Decreases the amount of color in the image.</li> <li>▶ Increases the amount of color in the image.</li> </ul> <p><b>Curve color</b> setting is adjusters at the factory to the display's color temperature. Temperature range is from 6000K to 9950K. So, user easily color set whitout adjustments Red, Green and Blue(R/G/B).</p>
---	--

<p><b>Degauss</b></p> 	<p>Used to demagnetize the picture to give a move accurate image and color.</p>
---	---











<p><b>OSD Control</b></p>  	<p>This item gives access to 3 elements : Timer, Horizontal position and Vertical position.</p> <p><b>Timer</b> will be controled OSD display time from 5 second to 120 second.</p> <p><b>Horizontal position</b> : To move image right and left.</p> <p><b>Vertical position</b> : To move image up and down.</p>
---	--

OSD Adjust	Description
<p><b>OSD Recall</b></p> 	<p>If the monitor is operating in a factory preset mode, this control will reset the image to the factory preset mode. If the monitor is operating in a user mode, this control has no effect.</p>
<p><b>Language Select</b></p> 	<p>To choose the language in which the control names are displayed. OSD Menus are available in five language : <b>English, German, French, Spanish and Italian.</b></p>
<p><b>Mode Information</b></p>    	<p>This item gives access to 3 elements : Mode, Absence and DDC function. The message does not disappear until you click the select key again.</p> <p><b>MODE</b> To inform users of preset and user mode data.</p> <p><b>ABSENCE</b> This message indicates the monitor is <b>ON PROCESSING</b> even through you are away for some time due to another matter.</p> <p><b>DDC</b> To select the DDC 2B<math>\oplus</math>, DDC2AB, DDC1/2B and OFF function.</p>
<p><b>Exit</b></p> 	<p>To disappear of the OSD on the screen.</p>

## Sound Selection and Adjustment ( )

You were introduced to the procedure of selection and adjusting an item using the OSD system.

Listed below are the icons, icon names, and icon descriptions of the items that are shown on the main Menu.

OSD Adjust	Description
 <b>Volume</b> 	Raises or lowers audio level.
 <b>Treble</b> 	Raises or lowers treble level.
 <b>Bass</b> 	Raises or lowers Bass level.
 <b>Balance</b> 	Changes balance of left/right speaker level.
 <b>Microphone</b> 	Enables or disables microphone usage.

## Video Memory Modes

The monitor has 32 memory locations for display modes, 7 of which are factory preset to popular video modes.

### Factory Preset Timing Signal Chart

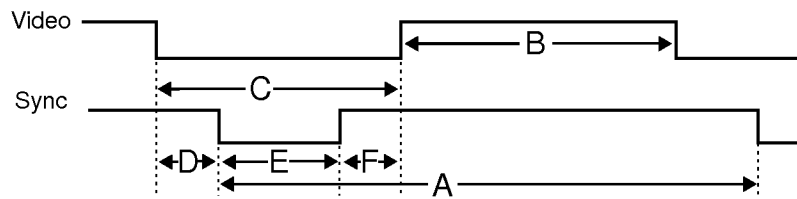

		Mode1	Mode2	Mode3	Mode4	Mode5	Mode6	Mode7		
H O R I Z O N T A L	Polarity	-	+	-	+	+	+	+		
	Frequency	kHz	31.47	37.88	43.27	53.68	60.02	63.98	68.677	
	Total Period	uS	31.78	26.40	23.11	18.63	16.66	15.63	14.561	A
	Data Period	uS	25.42	20.00	17.78	14.22	13.00	11.85	10.836	B
	Blanking	uS	6.36	6.40	5.33	4.41	3.66	3.78	3.725	C
	Front Porch	uS	0.64	1.00	0.89	0.57	0.20	0.44	0.508	D
	Pulse Width	uS	3.81	3.20	1.33	1.14	1.22	1.04	1.016	E
	Back Porch	uS	1.91	2.20	3.11	2.70	2.24	2.30	2.201	F
V E R T I C A L	Polarity	+	+	-	+	+	+	+		
	Frequency	Hz	70.08	60.32	85.01	85.07	75.03	60.02	85.00	
	Total Period	mS	14.269	16.579	11.763	11.755	13.328	16.661	11.764	A
	Data Period	mS	12.712	15.840	11.093	11.178	12.795	16.005	11.182	B
	Blanking	mS	1.557	0.739	0.670	0.577	0.533	0.656	0.582	C
	Front Porch	mS	0.414	0.026	0.023	0.018	0.017	0.015	0.014	D
	Pulse Width	mS	0.063	0.106	0.069	0.056	0.050	0.047	0.044	E
	Back Porch	mS	1.080	0.607	0.578	0.503	0.466	0.594	0.524	F
Resolution		640 × 400	800 × 600	640 × 480	800 × 600	1024 × 768	1280 × 1024	1024 × 768		
Recall		YES	YES	YES	YES	YES	YES	YES		

---

**User Modes**

Modes 8-32 are empty and can accept new video data. If the monitor detects a new video mode that has not been present before or is not one of the preset modes, it stores the new mode automatically in one of the empty modes starting with mode 8.

If you use up the 25 blank modes and still have more new video modes, the monitor replaces the information in the user modes starting with mode 8.

**Recalling Display Modes**

When your monitor detects a mode it has seen before, it automatically recalls the image settings you may have made the last time you used that mode.

You may, however, manually force a recall of each of the seven preset modes by pressing the Recall button. All preset modes are automatically recalled as the monitor senses the incoming signal.

The ability to recall the preset modes is dependent on the signal coming from your PC's video card or system. If this signal does not match any of the factory modes, the monitor automatically sets itself to display the image.

## Energy Saving Design

This monitor complies with the EPA's Energy Star program, which is a program designed to have manufacturers of computer equipment build circuitry into their products to reduce power consumption during time of non-use.

This monitor also goes into its energy saving mode if you exceed the monitor's operating limits, such as the maximum resolution of 1280x1024 or the frequency refresh rates of 30-70kHz horizontal or 50-160Hz vertical. When this monitor is used with a Green or EPA Energy Star PC, or a PC with a screen blanking software following the VESA Display Power Management Signalling (DPMS) protocol, this monitor can conserve significant energy by reducing power consumption during periods of non-use. When the PC goes into the energy saving mode, the monitor will go into a suspended operation state, indicated by the Power LED light changing from a green color to an amber color. After an extended period in the suspended mode, the monitor will then enter a semi-OFF mode to conserve more energy. In the semi-OFF mode or DPMS OFF mode as we call it in our specifications, the Power LED will still show an amber color. When you awaken your PC by hitting a key or moving the mouse, the monitor will also awaken to its normal operating mode, indicated by the green Power LED light. By following these conventions, the power consumption can be reduced to the following levels:

### Power Consumption

	Hori.	Verti.		Power	
Normal(Max.)	On	On	Normal	≤ 130W	Green
Stand-by	Off	On	Off	≤ 30W	Amber
Suspend	On	Off	Off	≤ 30W	Amber
Off	Off	Off	Off	≤ 5W	Amber

## Low Radiation Compliance (MPR II)

---

This monitor meets one of the strictest guidelines available today for low radiation emissions, offering the user extra shielding and an antistatic screen coating. These guidelines, set forth by a government agency in Sweden, limit the amount of emission allowed in the Extremely Low Frequency (ELF) and Very Low Frequency (VLF) electromagnetic range.

### Self Diagnostics



This monitor can sense when there is a possible problem present, and informs you of this condition by presenting you with a **SELF DIAGNOSTICS** OSD. This OSD may pop up when it is **On** but no signal is detected. In this case the message **CHECK SIGNAL CABLE** will be high lighted, alerting you to check the signal cable connections.

### DDC (Display Data Channel)

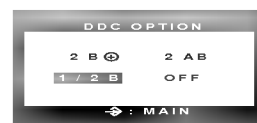

DDC is a communication channel over which the monitor automatically informs the host system (PC) about its capabilities. This monitor has three DDC function; DDC2B ⊕, DDC2AB and DDC1/2B. DDC2B ⊕ and DDC2AB carry out uni-directional communication between the PC and the monitor. Under these situations, the PC sends display data to the monitor but not commands to control the monitor settings. DDC1/2B has the function of bi-directional communication. For example, the PC can fetch screen data from monitor and adjust the screen with the PC keyboard.

**Note** : PC must support DDC functions to do this.

If your monitor is displaying a monochrome image or the wrong resolution, select the DDC OFF function.

## Why LGE'S Ultra-Contrast?

### 1. We adopted 43.5% Dark Tint Glass to improve contrast:

- Dark Tint Glass increases contrast.
- Transmission depends on the thickness of glass.

### 2. We highly up-graded contrast without brightness impairment:

- Sputtering coating with 6-layers dielectric structure give the Anti-Reflection effect, Anti-Static effect.

### 3. The lowest Reflectivity gives the best contrast.

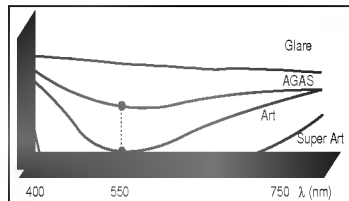

Coating Type	Reflectivity (%)	Quality	Quality
Super Art Coating	Under 0.3%	excellent	excellent
Art Coating	1.3%	good	good
AGAS Coating	2.5%	good	better
Glare		bad	excellent
Other coating types (competitors)	0.5%-1.5%	good	good

### 4. The full compliance to TCO 95 by tube itself without compensation circuit in monitor.

	MPE II	TCO95	TCO95
	Under 2.5V/m (50cm ahead)	Under 1V/m (30cm ahead)	Under 1V/m (30cm ahead)
VLEF	O	O	O
Emission	O	O	O
Energy Saving	X	O	O
Safety	X	O	O
Ergonomic	X	X	O
Environment	X	X	O

\* TCO : The Swedish Confederation of Employees  
 \* VLEF : Very Low Frequency Electrical Field

### 5. Comparison of contrast and brightness.

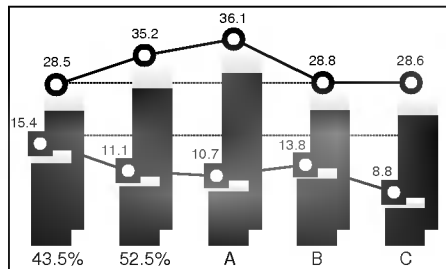

Contrast		
U-Contrast	155%	100% Excellent
A Maker	110%	145% Good
Other Type	100%	130% Good

\* Test Conditions  
 Brightness (FL) : 1k = 500 uA,  
 under scan (310 x 230mm)  
 Contrast ratio : 500 Lux

### 6. Performance

- Clear colors for windows working.
- Vivid images for graphic environment.
- Real-like effect for MPEG.
- More enjoyable for Multi-Media Game.



## Troubleshooting

---

### Self diagnostics message.

- The signal cable is not connected.
- 

### OUT OF FREQUENCY message appears.

- The frequency of the sync input is outside the operating range of the monitor.

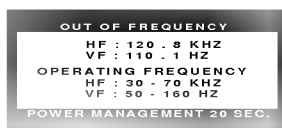

**\*Horizontal Frequency: 30-70kHz**

**\*Vertical Frequency: 50-160Hz**

Use the graphics board's utility software to change the frequency setting (Refer to the manual for graphics board).

---

### The power LED is illuminated amber.

- Display power management mode.
  - There is no sync signal.
  - The signal cable is not fastened securely.
  - Check the computer power and graphics adapter configuration.
- 

### The image on the SCREEN is not centered, or too small, or not a rectangle shape.

- Image adjustment not been done yet in the current operating mode. Use the SELECT and ◀ or ▶ buttons to set the image to your liking.
- 

### The monitor doesn't enter the power saving off mode (Amber).

- Computer video signal is not VESA DPMS standard. Either the PC or the video controller card is not using the VESA DPMS power management function.
-

## Service

---

Unplug the monitor from the wall outlet and refer servicing to qualified service personnel when :

- The power cord or plug is damaged or frayed.
- Liquid has been spilled into the monitor.
- The monitor has been exposed to rain or water.
- The monitor does not operate normally following the operating instructions. Adjust only those controls that are covered in the operating instructions. An improper adjustment of other controls may result in damage and often requires extensive work by a qualified technician to restore the monitor to normal operation.
- The monitor has been dropped or the cabinet has been damaged.
- The monitor exhibits a distinct change in performance.
- Snapping or popping from the monitor is continuous or frequent while the monitor is operating. It is normal for some monitors to make occasional sounds when being turned on or off, or when changing video modes.

---

Do not attempt to service the monitor yourself, as opening or removing covers may expose you to dangerous voltage or other hazards. Refer all servicing to qualified service personnel.

---

When replacement parts are required, have the service technician verify in writing that the replacements used have the same safety characteristics as the original parts. Use of manufacturer specified replacements can prevent fire, shock, and other hazards.

---

Upon completion of any service or repairs to the monitor, ask the service technician to perform the safety check described in the manufacturer's service manual.

---

When a video monitor reaches the end of its useful life, improper disposal could result in a picture tube implosion. Ask a qualified service technician to dispose of the monitor.

---

## Specifications

### Sync Signal Types

Type	H. Sync	V. Sync
Separate Sync	H. Sync	V. Sync

(N.C : No Connection)

### Signal Connector Pin Assignment

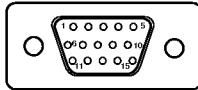

Pin	Signal (PC Side)
1	Red
2	Green
3	Blue
4	Ground
5	Self-Test
6	Red Ground
7	Green Ground
8	Blue Ground
9	NC
10	Ground
11	Ground
12	SDA
13	Hori.Sync
14	Vert.Sync
15	SCL

**Note** :No. 5 Pin have to ground on the PC side.

## Specifications

---

### Picture tube

- 17 inches (15.9 inches viewable) FST
- 90 degree deflection
- 0.28 mm dot pitch, Non-glare, Darkface
- Ultra Contrast CDT

### Sync Input

- Horizontal Frequency : 30 - 70kHz (Automatic)
- Vertical Frequency : 50 - 160Hz (Automatic)
- Input Form : Separate, Positive/Negative
- Signal input : 15 pin D-Sub Connector

### Video Input

- Display Area : 12.2 x 9.06 inches / 310 x 230mm (H x V)
- Input Form : Separate, RGB Analog, 0.7 V<sub>p-p</sub>/75 ohm, Positive
- Resolution : 1280 x 1024, 60Hz

### Audio

- RMS Audio Output: 4 W (R+L)
- Input Sensitivity : 0.7 V<sub>rms</sub>
- Built-in MIC : E.C.M type (Electret Condenser Microphone)

### Power input

- 100-240VAC 50/60Hz 2.0A

### Dimensions (with tilt/swivel stand)

- Width : 465 mm/18.3 inches
- Height : 435.5 mm/17.1 inches
- Depth : 442 mm/17.4 inches

### Weight

- Net : 19.5kg (42.9lbs)

Information in this document is subject to change without notice and does not represent a commitment on the part of LG Electronics Inc.