



Washing Machine

OWNER'S MANUAL

MODEL : WD-8030WF



Thank you for purchasing LG Fully Automatic Washer.
Please read your owner's manual carefully, it provides
instructions on safe installation, use and maintenance.
Retain it for future reference.
Record model number and serial number of washing machine.



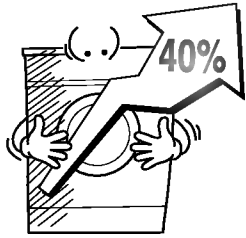

Jumbo Drum

LG's jumbo drum can wash about 40% more per load than conventional washing machine. A bigger drum improves the wash performance.

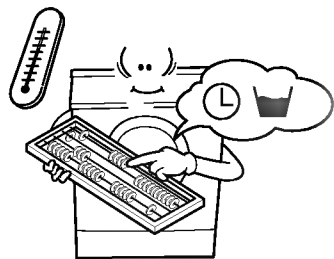

More economical by Fuzzy Logic System

Fuzzy Logic System detects the amount of load and water temperature, and then determines the optimum water level and washing time to minimize energy and water consumption.



Child-Lock

The Child-Lock system has been developed to prevent children from pressing any button to change the program during operation.

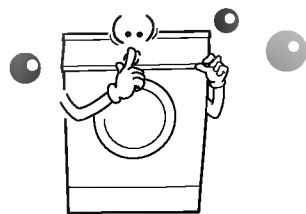

Low noise speed control system

By sensing the amount of load and balance, evenly distributes load to minimize the spinning noise level.

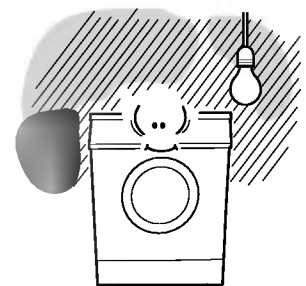

Auto Restart

Although the washing machine is turned off by a power failure, it restarts automatically in its stopped process when power is supplied again.

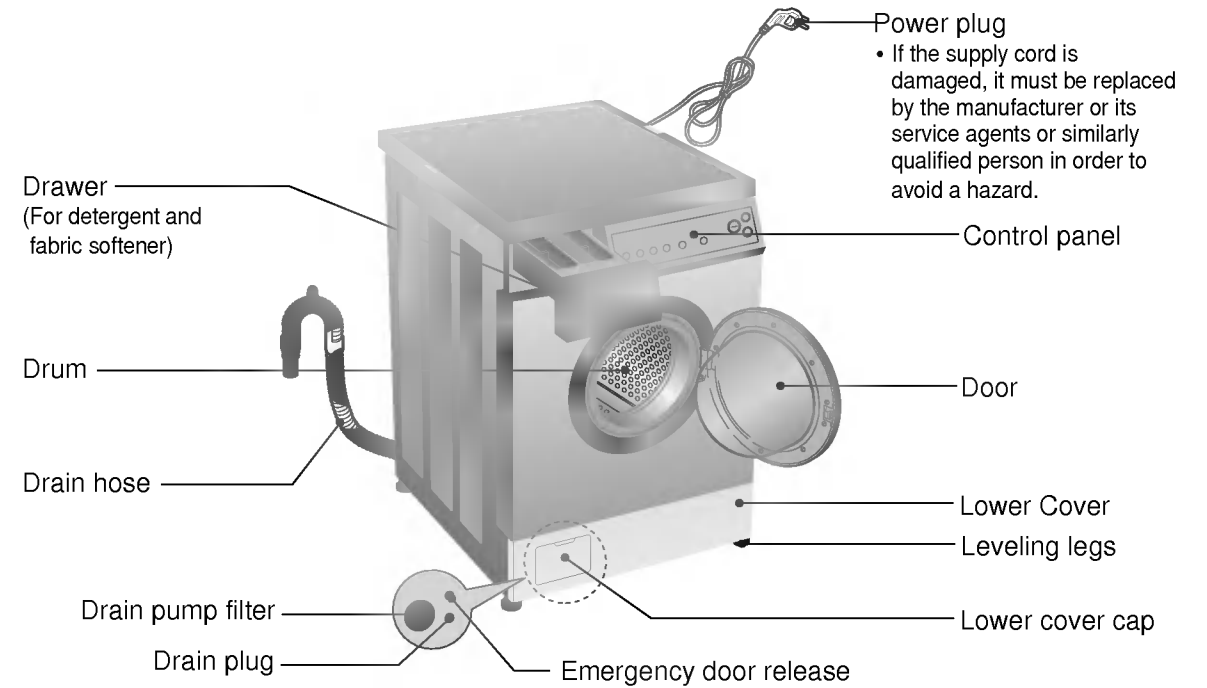

Power plug
 • If the supply cord is damaged, it must be replaced by the manufacturer or its service agents or similarly qualified person in order to avoid a hazard.

■ Name	: Front loading washing machine
■ Power supply	: 220-240V, 50Hz
■ Size	: 600mm(W) × 600mm(D) × 850mm(H)
■ Weight	: 67kg
■ Wash capacity	: 7.0kg
■ Heating	: 2200W
■ Wash speed	: 45rpm
■ Spin speed	: 600 / 800 rpm
■ Water consumption	: 67 ℓ (9.6 ℓ/kg)
■ Permissible water pressure	: 0.3-10kgf/cm ² (30-1000kPa)
■ Accessories	: Inlet hose (1EA), Spanner(1EA)

* The appearance and specifications may be varied without notice to raise the units quality.

Product Features	2
Specification	3
Installation.....	4
Warnings.....	6
Preparing your laundry / Adding detergent	7
Function of each button	8
How to use your washing machine	10
Maintaining	12
Trouble-shooting guide	14

■ Removing the transit bolts

• To protect the washer during transportation, the special 4 bolts are locked. Before operating the washer, remove the bolts. (If they are not removed, it may cause heavy vibration, noise and malfunction)

1. Locate the 4 bolts that secures the washer.
2. Unscrew the 4 bolts with a spanner provided.
3. Take out the 4 bolts
4. Keep the transit bolts and spanner for future use.

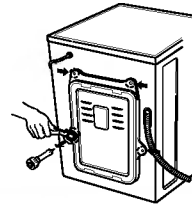

- If the appliance is supplied from a cord extension set or electrical portable outlet device the cord, extension set or electrical portable outlet device should be positioned so it is not subject to splashing or ingress of moisture.
- If a stationary appliance is provided with a supply cord and a plug, the instructions shall state that the appliance must be positioned so that plug is accessible.

■ Level adjustment

• If the washer is not levelled, it could cause noise or vibration.

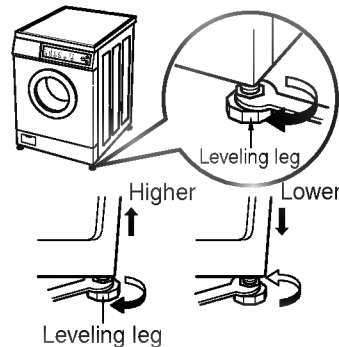

1. Select a place for installation
 - Place it at a firm and even floor.
 - Place it more than 2cm away from the wall
 2. Check the gap
 - Ensure all feet are firmly on the floor.
 3. After adjusting the level, check it by shaking the washer. Readjust the level if necessary.
- * The base opening must not be obstructed by carpeting when the washing machine is installed on a carpeted floor.

■ Electrical connection

- Do not use an extension cord or double adapter.
- If the supply cord is damaged, it must be replaced by the manufacturer or its service agents or similarly qualified person in order to avoid a hazard.
- Always unplug the machine and turn off the water supply after using.
- Connect the machine to an the exclusive AC 220 – 240V outlet with ground terminal.

■ Water drain

- Hooked over the edge of a sink using the plastic hose hanger supplied with the machine.
- Make sure there are no kinks in the hose and that it is no crushed. Secure the hose so that it can not be dislodged while the appliance is running.
- The drain hose should not be placed higher than 85cm above the floor.

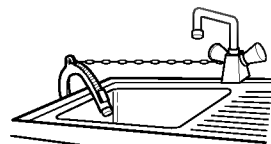

■ Connecting the inlet hose

1. Unscrew the fixing screw to attach the faucet.
2. Push the connector up till the rubber packing is in tight contact with the faucet. Then tighten the 4 screws.
3. Push the water supply hose vertically upwards so that the rubber packing within in the hose can adhere completely to the faucet and then tighten it by screwing it to the right.

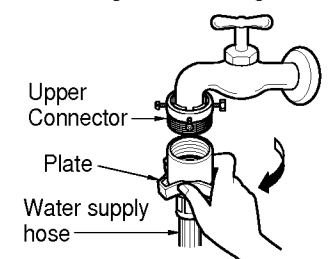
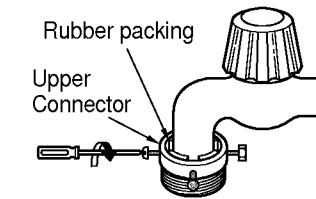
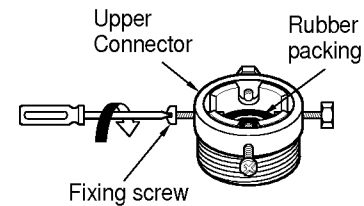

Used the horizontal faucet

Horizontal faucet



Extension faucet



Square faucet

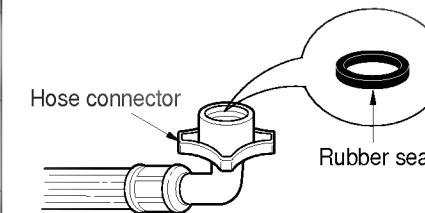

- Make sure that the rubber seal is inside the hose connector.

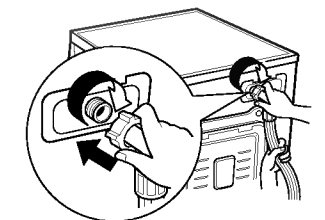

- Your machine comes with only cold water connection.
- Make sure that there are no kinks in the hose and that it is not crushed.

■ Connecting the inlet hose (How to connect the hose of screw type.)

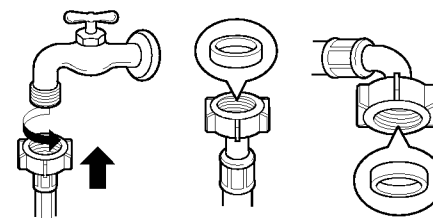
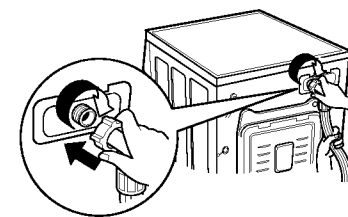

- Two rings are supplied with the water inlet hose in the valve connector in order to prevent water leaks.
- Your machine comes with only cold water connection. Connect to cold water using the inlet valve.
- Check water tightness of washing machine connections by turning the tap completely on.
- Periodically check the condition of the hose and replace the hose if necessary.
- Make sure that there are no kinks in the hose and that it is not crushed.

■ **You must read the whole of this instruction book before you use the appliance. Follow the advice carefully. Keep the book for future reference. If you sell or give away the appliance, make sure that the book is passed to the new owner.**

■ **The following warning are provided in the interests of overall safety. You must read them before the appliance is installed or used.**

- This appliance is designed to be used by adults. Children should not be allowed to touch the controls or play with the product.
- It is dangerous to modify the specifications of this appliance in any way.
- This appliance is heavy. Care should be taken when moving it.
- All packaging and transit bolts must be removed before the appliance is used. Serious damage may occur if this is not done.
- Any plumbing work required to install this appliance should be carried out by a qualified plumber or a competent person.
- Any electrical work required to install this appliance should be carried out by a qualified electrician or a competent person.
- Make sure that the appliance does not stand on its electrical supply cable.
- If the machine is situated on a carpeted floor, please adjust the feet to ensure that air can circulate freely.
- Always unplug the appliance and turn off the water tap after use.
- Do not overload the appliance.
- Only wash fabrics which are designed to be machine washed. If in doubt, follow the instruction you find on the label of the item itself.
- Avoid electric heaters, candles, etc. near the machine. It may ignite or deform the machine.
- Don't sprinkle water. It may cause a fire or electric shock.

- Use the exclusive AC 220V-240V outlet with ground terminal. Do not use an extension cord or double adapter.
- Make sure that all pockets are empty. Hard, sharp objects such as coins, safety pins, nails, screws or stones can cause extensive damage.
- Do not wash laundry stained with edible oil, machine oil, dry-cleaning oil, gasoline, etc. It may cause fire or explosions.
- This appliance is designed for domestic use. It must not be used for purposes other than those for which it was designed.
- Do not machine wash fabrics which are saturated with petroleum products. If volatile cleaning fluids have been used, make sure that they are thoroughly removed from the fabric before it is placed in the appliance.
- Do not operate near places with ignitable material such as gasoline, benzene, etc. or inflammable gas leak. Due to volatile nature of these material, It can cause fire or explosions.
- Use only the recommended quantities of fabric softener. An excessive amount could damage the laundry.
- Leave the porthole door slightly ajar between washes to preserve the door seal.
- Before you open the door of the machine check that the water has drained. Do not open the door if you can still see water.
- Pets and children may climb into the washing machines. Check you appliance each time before use.
- The glass door becomes very hot during washing. Keep children away from the appliance while it is in use.
- You should not attempt to repair the machine yourself. Repairs carried out by inexperienced or unqualified persons may cause injury and/or more serious faults to the machine.
- This product should be serviced by an authorized Service Centre only, and only genuine spare parts should be used.
- When disposing of your old washing machine, the electric cable must be cut off and the door catch must be made inoperative to avoid it becoming a death trap for a child.

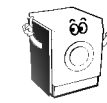

- Check pocket for any articles (coin, safety pin, paper clips, etc.)
- Close zips and fasten button or hooks: loose belt or ribbons should be tied together.
- Never wash whites and coloureds together.
- Follow the wash code symbols on each garment label and manufacturer's washing instructions.

Soiled condition	Washing	Temperature
Heavy soiled	- Pre wash - Main wash	Heavily soiled cottons : cold - 95°C
		Normally soiled cottons : cold - 95°C
		Coloured cottons : cold - 60°C
		Synthetics : cold - 60°C
Normal soiled	- Main wash	Delicate fabrics : cold - 40°C
		Woollens : cold - 40°C

■ Where to place the detergent

- Pull out the detergent drawer.
- Put the detergent and fabric softener in the detergent drawer before washing.
- Close the detergent drawer completely.

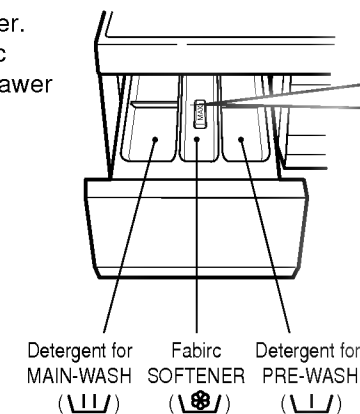

The drawer for fabric softener

- Do not leave the fabric softener in the detergent drawer for more than 2 days. (Fabric softener could harden)
- Do not open the detergent drawer during water fill cycle.
- Softener will automatically add during last rinsing cycle.
- Do not fill past MAX indicator.
- Do not use solvents (trilen, benzene, etc.)

Softener level The diagram shows two containers. The left one has a water level below the 'MAX' line and is marked with a checkmark. The right one has a water level above the 'MAX' line and is marked with an 'X'.

- Programmes with PRE-WASH
- MAIN-WASH only

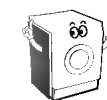

- The detergent should be used according to the instruction of the detergent manufacturer.
- If the detergent is used over the recommended amount too many bubbles will be generated thus causing an inferior washing result. This will also cause a malfunction.
- Use front loader detergent only for drum washing machine.

Detergent dosages

Do not exceed manufacturer's recommended dosages as shown on the detergent package.

- The amounts depend on
- degree and type of soiling
 - size of wash

- full load : according to manufacturer's instructions
- part load : 3/4 of the normal amount
- minimum load (about 1kg) : 1/2 the amount used for full load

- water hardness in your area.

Choosing the right detergent

The type of detergent depends on

- the type of fabric (cotton, synthetic, delicate items, wool)
- colour
- wash temperature
- degree and type of soiling

Note : Use appropriate detergents only for wool.

- If you desire to leave your fabrics in the machine without spinning after rinse to prevent them getting wrinkled, you may select Rinse Hold function pressing the Rinse button.
- To drain and spin, press the Rinse button to turn off the Rinse Hold lamp.

Water temperature selector

- Press the button to select water temperature.
- The water temperature can be selected [40°C → 60°C → Cold] during Coloreds program.
- 95°C is selected only for Whites program.

- 6 programs can be set depending on the type of the laundry.
- If the power button is pressed, the Coloreds program is set automatically.
- By pressing the button, [Coloreds → Whites → Rapid → Delicate → Wool → Synthetic] can be selected.

- Use the button to start or pause wash cycle.
- The power turns off automatically 4 minutes after the pause button is pressed.

- Press the button to turn on and off.

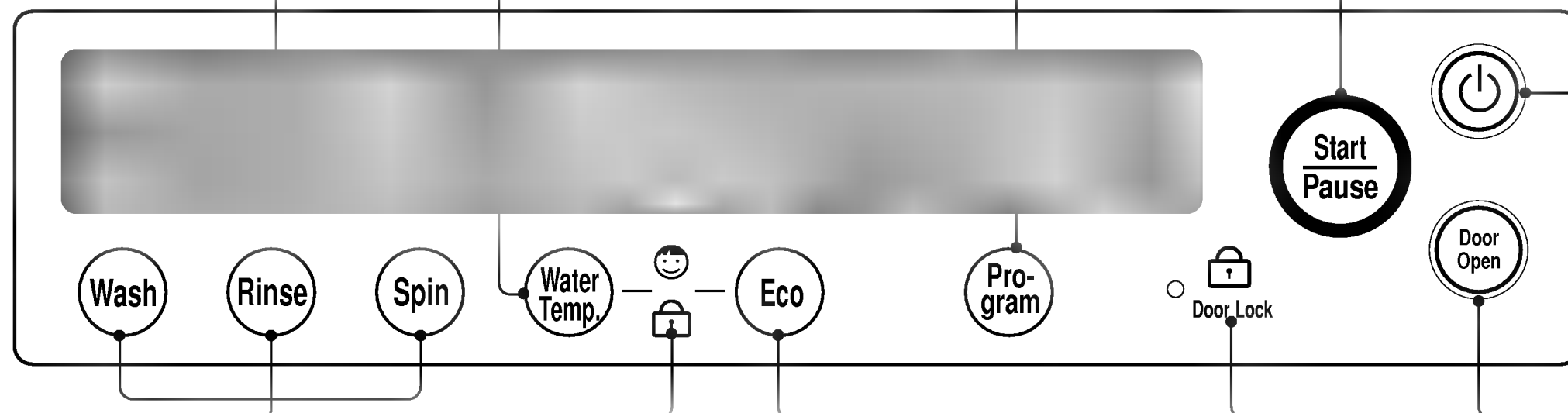

For manual wash, rinse and spin speed

- Use these buttons to change washing method, rinse method and spin speed.
- When lamp is off, no selection has been made.
- Prewashing is available for Coloreds, Whites, Synthetic program.

- The Child Lock system can be programmed and canceled by pressing both [Water Temp.] and [Eco] buttons simultaneously. Once this system is set, all buttons are inoperable work during operation. (Child Lock Lamp is on when it is selected)
- The Child Lock system can be set at any time even including during Power-Off, on Pause and operation. It is automatically cancelled when operational error occurs and when end of the cycle ends.

- If you push the Eco button in while Whites program, Eco function is selected. Eco function gives you almost the same washing effect as that in 95°C with less energy consumption

- It shows whether the door can be open or not during the washing cycle.
- If the light is off, the door can be opened.

- Press the button to open the door.
- Only operate when power plug is connected.

- ❑ The whole washing process is carried out automatically with just one touch.
- ❑ If no programme is selected coloreds program will commence.

■ In case of automatic washing

1. Press **[Power]** button.
2. Press the **[Start/Pause]** button to start the washing machine.
3. The coloreds program is carried out automatically.
 - The optimum wash programme is selected once the load is detected.

■ To change the washing program preferred

1. Press **[Power]** button.
2. Coloreds → Whites → Rapid → Delicate → Wool → Synthetic.
will appear in order by pressing the **[Program]** button.
 - Make adjustment to water temperature, rinse or spin cycles to suit your wash needs by pressing these buttons.
 - The time required can be slightly changed according to the laundry amount, water supply and water temperature.

Program	Description	Select the function to change rinse, spin and water temperature. () indicates choice that can be manually taken.				Washing time
		Wash	Rinse	Spin	Water Temp.	
Coloreds	Color fast garments (shirts, night dresses, pajamas) and lightly soiled white cotton (underwear...)	Main wash (Pre + Main)	3 times (super 4times)	800 (600, no Spin)	40°C (Cold, 60°C)	about one hours & 46 minutes
Whites	First check if the laundry is machine washable. White cottons and linen (towels, sheets...)	Main wash (Pre + Main)	3 times (super 4times)	800 (600, no Spin)	95°C	about 2 hours & 20 minutes
Rapid (Below 2.5kg)	For quick washing of less dirty laundry or frequently used towels.	Main wash	2 times (super 3times)	600 (800, no Spin)	Cold (40°C)	about 46 minutes
Delicate (Below 2kg)	Delicate laundry easily shaped or damaged. (Silk, curtains...)	Main wash	3 times (super 4times)	600 (no Spin)	Cold (40°C)	about one hour & 49 minutes
Wool	Polyamide, Acrylic, Polyester	Main wash	2 times (super 3times)	600 (no Spin)	Cold (40°C)	about 45 minutes
Synthetic	Only machine washable woolens with pure new wool label.	Main wash (Pre + Main)	3 times (super 4times)	800 (600, no Spin)	40°C (Cold, 60°C)	about one hour & 46 minutes

[More convenient manual operations of Coloreds program]

It is more convenient to operate manually in Coloreds program than in others because Coloreds program is firstly set with power on.

In Coloreds,

- When you want wash only, press the **[Wash]** button to select the washing method.
- When you want rinse only, press the **[Rinse]** button to select the rinsing method.
- When you want spin only, press the **[Spin]** button to select the spin speed.
- When you want Wash & Rinse only, press the **[Wash]** button and **[Rinse]** button respectively to select each method.
- When you want Rinse & Spin only, press the **[Rinse]** button and **[Spin]** button respectively to select each method.

3. Press the **[Start/Pause]** button to start the cycle.
 - The optimum washing is carried out by detecting the amount of the laundry.



Completion of washing

- If the washing is completed, power turns off automatically after the alarm sound. Press the **[Door Open]** button and take out the laundry.
- Switch off the appliance and turn off the water tap.

■ To change settings in Child Lock mode.

- Child Lock (If you want to lock all the buttons to prevent a child from setting, you can use this option.)

* The Child Lock system can be programmed and cancelled only by pressing both **[Water Temp.]** and **[Eco]** buttons simultaneously.

If you want to change the program when the Child Lock is on,

1. Press both **[Water Temp.]** and **[Eco]** buttons simultaneously.
2. Press the **[Start/Pause]** button.
3. Change the desired program and press the **[Start/Pause]** button.

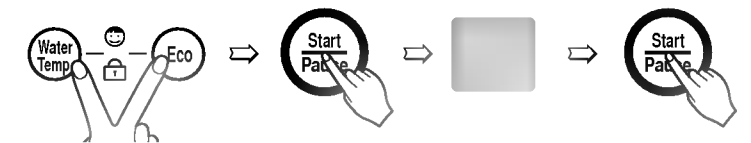

If you want to deactivate Child-Lock during wash cycle, press both **[Water Temp.]** and **[Eco]** buttons simultaneously again.



- If the light turns on, the door can not be opened.

■ Auto Restart

- Although the washing machine is turned off by a power failure, it restarts automatically in its stopped process when power is supplied again and the process is properly adjusted.
- And it will be the same when the machine unplugged in operation is plugged in again.

- ❑ Remove the power plug prior to maintaining.
- ❑ Clean the filter periodically every 3 months.

■ Clean the filter in the inlet valve

- If no water flows through filter and is clogged with foreign material, water is not charged.
- Remove the inlet hose completely before cleaning the filter.

1 Turn off the water taps.

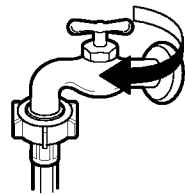

2 Take out the power plug from the outlet.

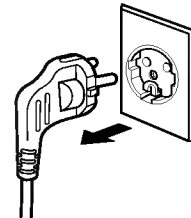

3 Disconnect the inlet hose.

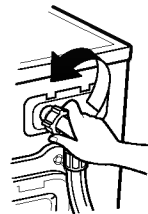

4 Remove the filter with a tool or by hand and take out foreign material using a toothbrush.

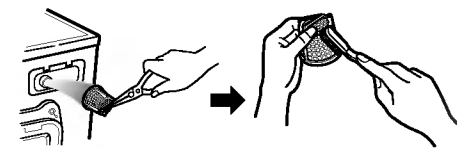

• Insert it in original place.

■ Cleaning the drain pump filter

1 Open the filter cover by using coin.

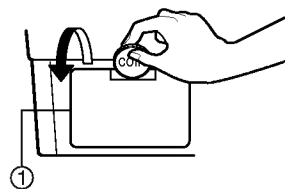

2 Take out the drain plug (①), then the water flows out. If the water does not flow any more, turn the drain pump filter (②) to the left until it is open.

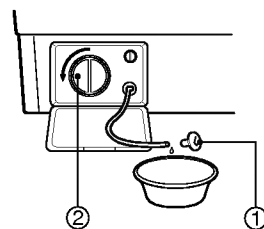

3 Take out any foreign material from the drain pump filter (②). After cleaning, turn the drain pump filter (②) clockwise and insert the drain plug (①) to the original place. Close the Lower cover cap.

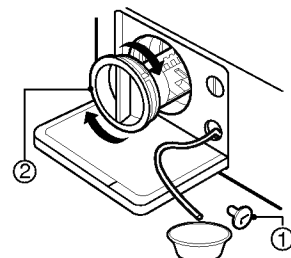

■ To prevent being frozen in winter

1 Turn off the water tap and remove the inlet hose.

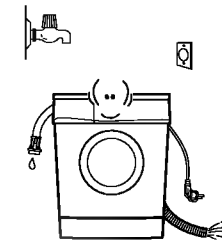

2 Drain water in the machine using drain plug (①).

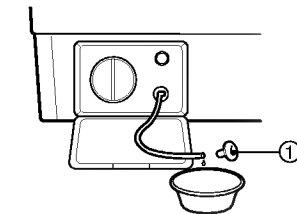

■ When the machine is frozen

1 Pour hot water (about 50 °C) on the faucet and remove the inlet hose.

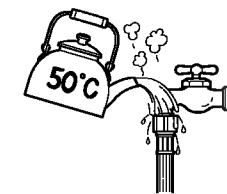

2 Submerge the separated hose in hot water (about 50 °C)

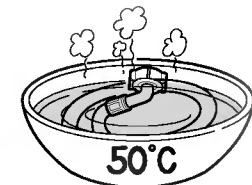

3 Pour the hot water in the drawer and maintain it for 10 minutes for melting.

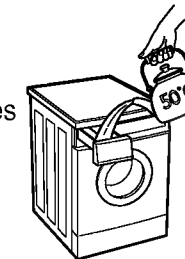

4 Connect the inlet hose to the water tap and check the drain after turning on the water tap and operating the washing machine.

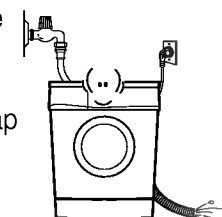

■ Maintenance of the drawer

1 Pull out the drawer.

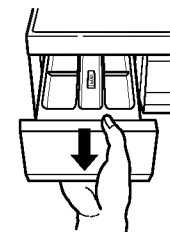

2 Wash it clearly

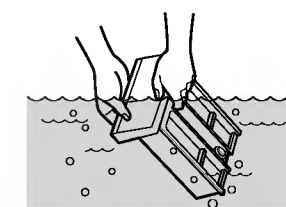



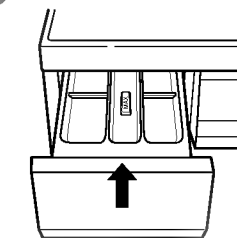





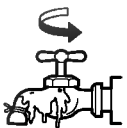

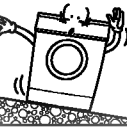
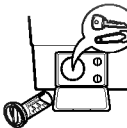
3 Insert it in its original place.

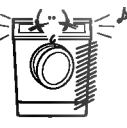

Trouble - Shooting guide

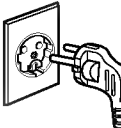
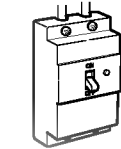
- ❑ Check the following before asking for service if the error message is displayed during washing, rinsing or spinning.
- ❑ Request for the service center or agent in the case of failure or damage except for the followings.

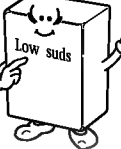
Symptom	Check points	Solution
<ul style="list-style-type: none"> ☀ Pre ☀ Main 	 <ul style="list-style-type: none"> • Is the water tap turned off ? • Is the water frozen?  <ul style="list-style-type: none"> • Is the water pressure low or the filter clogged ? 	<ul style="list-style-type: none"> • Turn the water tap on. • Melt it with 50°C hot water. 13 Refer • Separate the filter and remove the foreign material. 12 Refer
<ul style="list-style-type: none"> ☀ Rinse Hold ☀ Super ☀ Normal 	 <ul style="list-style-type: none"> • Is the laundry tilted to one side in the drum?  <ul style="list-style-type: none"> • Is the washer leveled ? 	<ul style="list-style-type: none"> • Spread the laundry evenly. • Release imbalance by pressing the start button. If it happens after rinsing or spinning, call the service centre. • Install it on a flat surface.
<ul style="list-style-type: none"> ☀ 800 ☀ 600 ☀ No Spin 	 <ul style="list-style-type: none"> • Is there foreign material in the drain pump ?  <ul style="list-style-type: none"> • Is the drain hose bent or higher than 85cm above the floor ? • Is the hose clogged ?  <ul style="list-style-type: none"> • Is the hose frozen ? 	<ul style="list-style-type: none"> • Remove foreign material. • Put the drain hose evenly. • Place the drain hose under 85cm from the floor. • Melt it with 50°C hot water.
<p>Door is faulty</p> <ul style="list-style-type: none"> ☀ Door Lock 	 <ul style="list-style-type: none"> • Did you run the washer while the door is not closed completely? 	<ul style="list-style-type: none"> • Close the door. * If it is not released, call the service center.
<p>Water is not heating</p> <ul style="list-style-type: none"> ☀ 95°C ☀ 60°C ☀ 40°C ☀ Cold 	<ul style="list-style-type: none"> • Take out the power plug. • Call the service center or agent. 	

Symptom	Check points	Solution
<ul style="list-style-type: none"> ☀ Coloreds ☀ Whites ☀ Rapid 	<p>It is displayed when the water pressure sensor malfunction.</p>	<ul style="list-style-type: none"> • Close the water tap. • Take out power plug.
<ul style="list-style-type: none"> ☀ Synthetic ☀ Wool ☀ Delicate 	<p>It is displayed when the water overfills due to abnormal water inlet valve.</p>	<ul style="list-style-type: none"> • Call the service center.
<p>The machine does not start up.</p>	 <ul style="list-style-type: none"> • Did you press the power button.  <ul style="list-style-type: none"> • Is the power plug unplugged?  <ul style="list-style-type: none"> • Is the short-circuit breaker turned off? 	<ul style="list-style-type: none"> • Turn it on. • Plug it in. • Turn it on.
<p>Excessive suds</p>	 <ul style="list-style-type: none"> • Did you put more detergent than recommended?  <ul style="list-style-type: none"> • Did you put low sud detergent on the front loading washing machine. 	<ul style="list-style-type: none"> • Put the recommended amount. • Use detergents only for front loading washing machine.
<p>Excessive vibration and noise.</p>	 <ul style="list-style-type: none"> • Did you remove the transit bolts? • Is the washer levelled? • Is the drain pump clogged with foreign material ? 	<ul style="list-style-type: none"> • Remove it. • Place it on an even floor. • Remove foreign material from the drain pump. 12 Refer