

# Washing Machine **OWNER'S MANUAL**

**MODELS : WF-561(2) / 571(2)SPP  
WF-611(2) / 621(2)STP**

Please read the operating instructions carefully and thoroughly before installing and operating your washing machine.

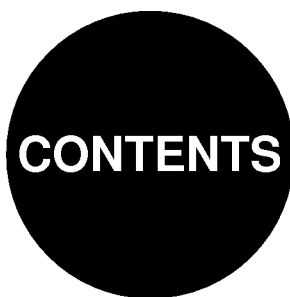



# CONTENTS

FEATURES .....	3
PARTS IDENTIFICATION.....	4
NAMES OF THE FUNCTION SELECTORS.....	5
INSTALLATION.....	6~8
WASH PROGRAM.....	9
OTHER WASHING PROGRAMS .....	10~11
RESERVATION WASHING PROGRAM.....	12~13
SELECTABLE WASHING METHODS.....	14
MAINTENANCE .....	15
GUIDANCE FOR SAFETY AND DURABILITY .....	16
TROUBLE-SHOOTING GUIDE .....	17~18
SPECIFICATION.....	19

# FEATURES

- FUZZY
  - ECONOMY
  - SOAK
  - WOOL
- START  
PAUSE

⏻  
AUTO OFF

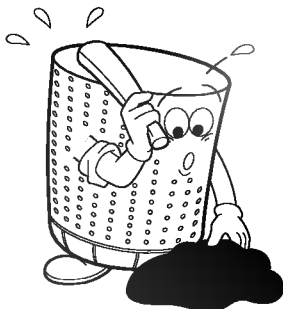
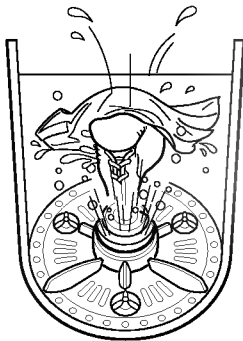

## ZZY

- Press AUTO OFF button and then START button.
- The micro computer does all chores, choosing the proper amount of water, cutting electric power and turning off 10seconds after wash program finishes.

## NOVATED WASHING WINGS

- Three small washing wings generate strong and sharp washing currents to clean laundry uniformly.
- Adjusted vertical movement and rotating direction of the washing punch reduces laundry entanglement and improves washing power.

## SERVATION AND DISPLAY

- Reserve the time when wash program ends from now to prevent wrinkle while you are away.
- It shows the time left of all Processes with TIME LEFT & MIN. or Reservation with RES. & HOUR.

## SHING INNER TUB

- The embossing wall of the TUB, together with rhythmic wave improve washing power by beating and rubbing laundry.
- Antimicrobial additive which prevents mildew from growing around Inner-tub is added in the plastic tub for cleaner wash.

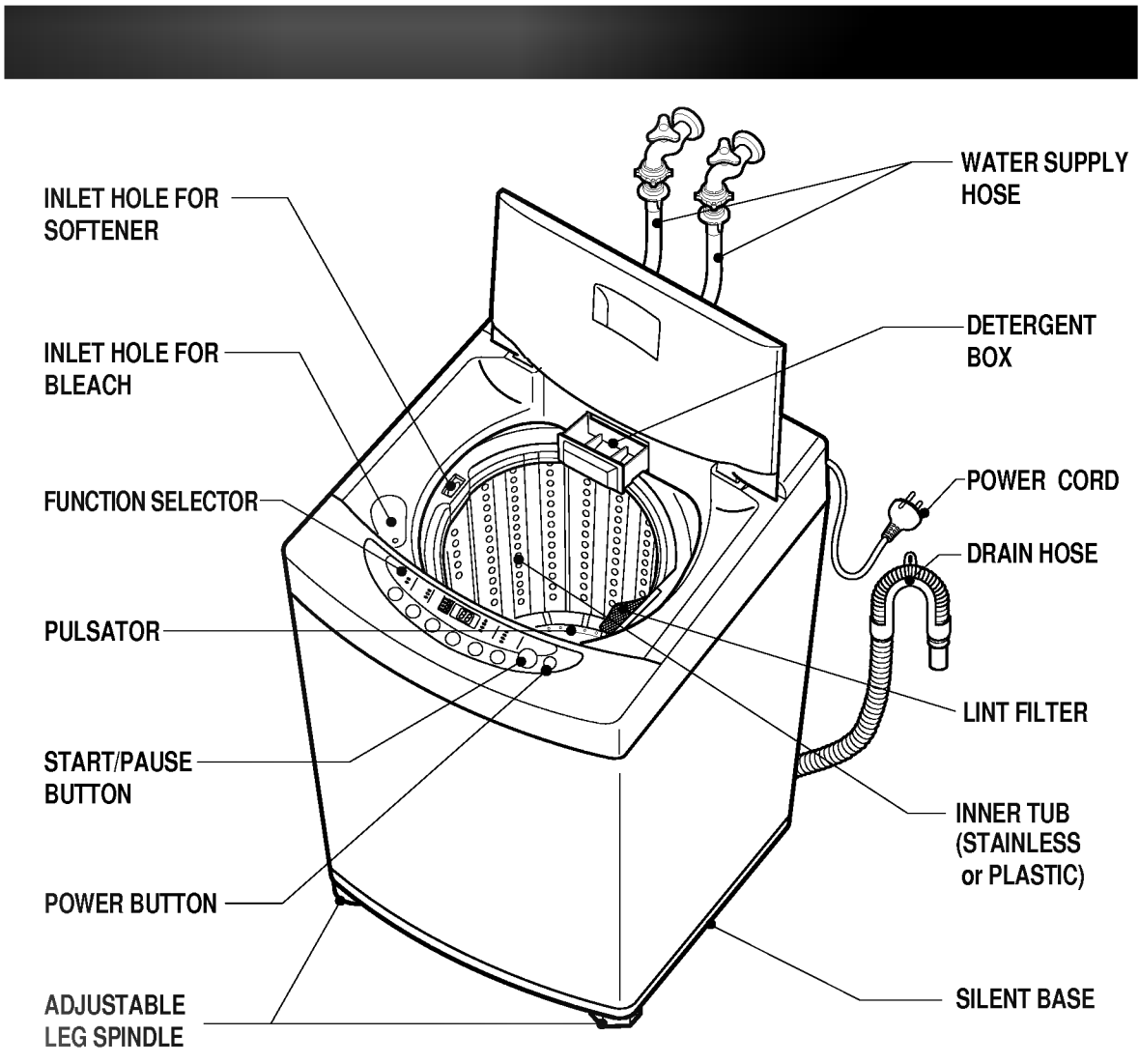

## ACCESSORIES

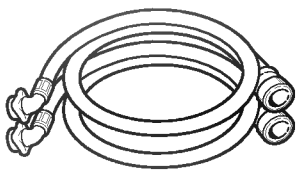
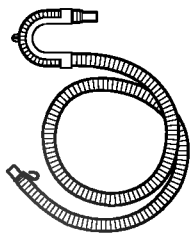
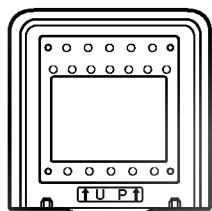
Inlet hose	Drain hose	Silent Cover
		 <p data-bbox="1134 1840 1232 1883">(Option)</p>

- If the signal sounds are bothering especially at night. Press process & program button at the same time. Signal function resumes by pressing two buttons again.

OPTION

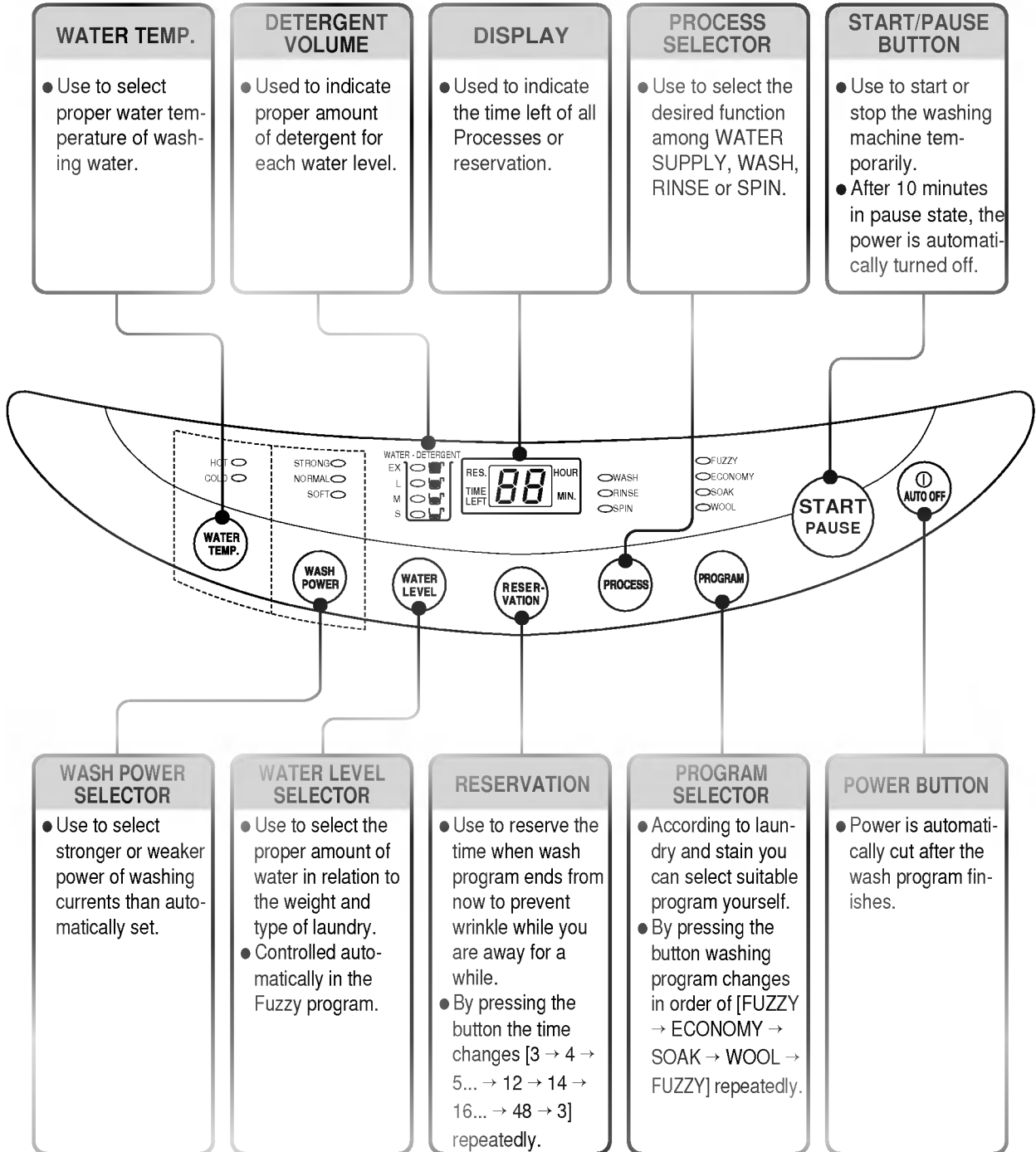

# INSTALLATION

## INSTALL THE WASHING MACHINE ON FIRM AND EVEN PLACE

- Install the washing machine on a flat and firm surface.
- Keep the washing machine over 15cm away from the wall to prevent a noisy sound while spinning.

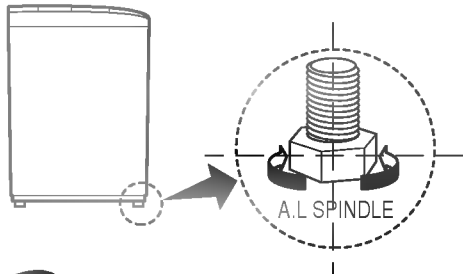
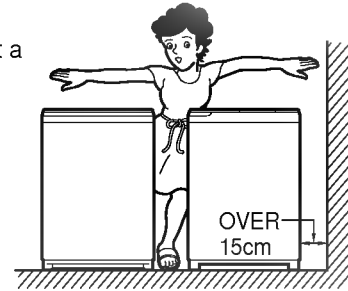

- When washing machine does not even out  
Turn A.L SPINDLE right or left to be level.

## CONNECT THE DRAIN HOSE

- Connect the drain hose to the outlet of the drain located at the back side of the washing machine.
- Fix the drain hose with the clip. And then push it toward the body as in the figure.

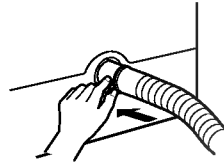
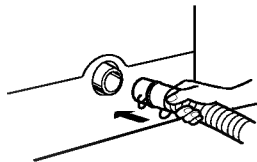

- Check out if the drain hose is hung up to proper location for drainage.
- Do not use an extension hose.
- The discharge height is approximately 0.9~1.3m from the floor.

## INSTALL SILENT COVER(option)

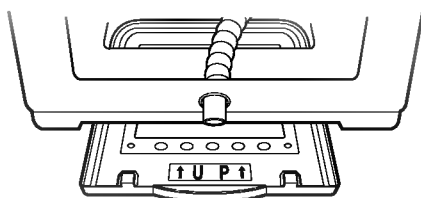

- Insert Silent Cover to be firmly fixed from the back of washing machine.

# CONNECT THE INLET HOSE

□ How to connect the hose of one touch type.

## Used the horizontal faucet.

Horizontal faucet



Extension faucet



Square faucet



1 Untighten the upper connector screw.

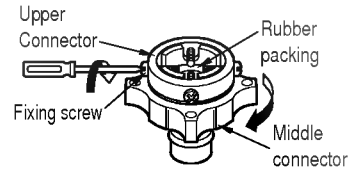

● In case the diameter of the faucet is large remove the guide plate.

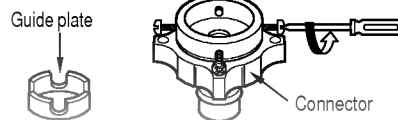

2 Push the upper connector up till the rubber packing is in tight contact with the faucet. Then tighten the 4 screws.

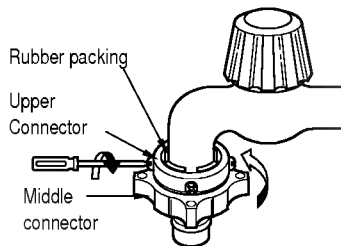

● Turn the middle connector not to have water leaked.

3 Connect the water supply hose to the middle connector, pushing the plate down.

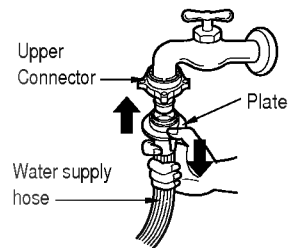

● To separate the water supply hose from the middle connector shut off the faucet. Then pull the inlet hose down, pushing the plate down.

● Connect the inlet hose to inlet valve of the washing machine, and then lock it by turning the hose connecting part. Check to see if there is a rubber seal inside the connector.

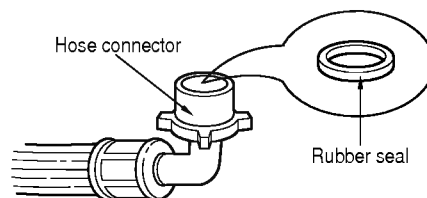
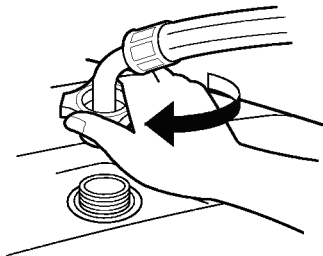

# INSTALLATION

## How to connect the hose of Nut type

- Turn the inlet Nut to the right hand direction as shown in the figure. Tighten it firmly to prevent water leakage.
- Connect the other end of the hose to the water valve on washer securely.
- Make sure that the rubber packing is inside the union nut.

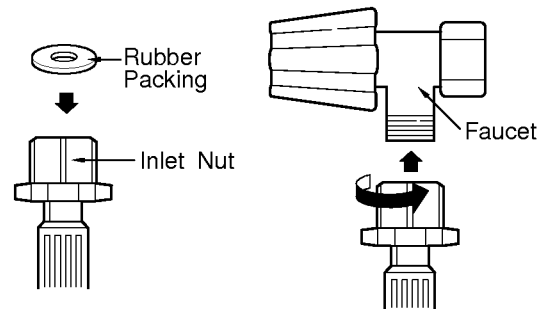

## GROUND THE EARTH WIRE

- Earth wire is installed to prevent electric shock caused by the current leakage.
- Earth wire is secured on the back side of the washing machine. Connect the earth wire to a metal faucet. In case the earth wire is connected to a plastic faucet, no effect is expected. When an earth wire is in the power cord assembly, an additional earth wire does not need.

## CAUTION

- Ground before the power plug is connected to the wall outlet.
- Never connect the earth wire to a gas pipe, a phone wire and a lightning rod.
- If the power supply cord is damaged, it must be replaced by a special cord or assembly available from the manufacturer or its service agent. All material used for enclosing the power supply cord connection have to be retained as origin after any services.
- The base openings must not be obstructed by carpeting, when the washing machine is installed on a carpet floor.

# PREPARATION BEFORE WASH



- Check if laundry is washable in water.

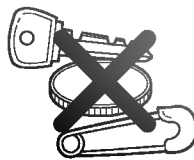

- Be sure to remove things such as keys, pins and coins from the laundry.



- Wash oily or dyed laundry separately.



- Shake loose dirt off before washing.



- Wash fluffy laundry by turning it inside out.

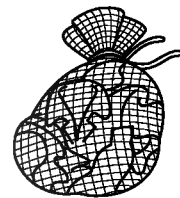

- Wash delicate clothes, wrapping them in a nylon net.



# WASH PROGRAM

## FUZZY WASH



- Use this program for normal clothes except for a blanket, woolen clothes, lingerie.
- All conditions are automatically set by micro computer.

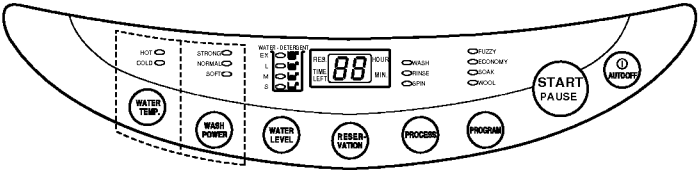

## WASHING PROCEDURE

**1** Press the power button.

- Fuzzy wash indicator lamp illuminates when the power is on.

**2** Put laundry in the tub.

**3** Press the START/PAUSE button.

**4** Put detergent as indicated on the display or instruction of detergent manufacturer. Close the lid.

WATER - DETERGENT

EX	
L	
M	
S	

- Electric power is automatically out after washing program finishes.

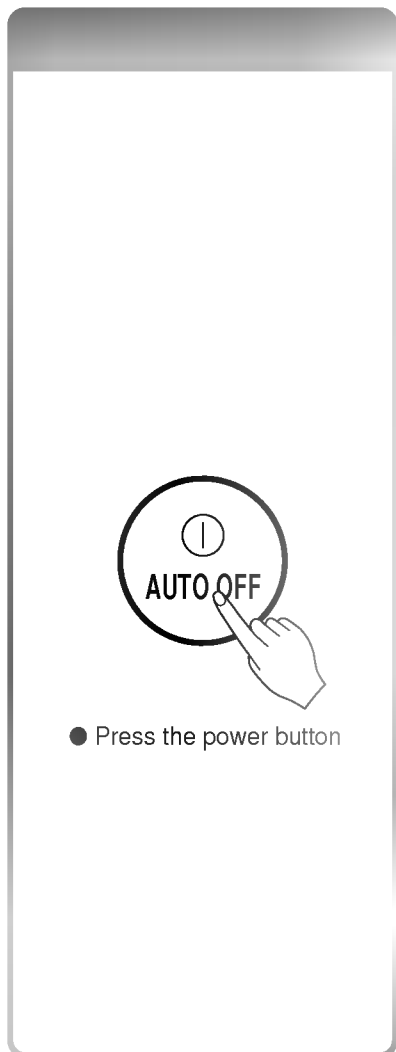

WASHING PROGRAMS	
<b>ECONOMY</b> <input type="radio"/> FUZZY <input checked="" type="radio"/> ECONOMY <input type="radio"/> SOAK <input type="radio"/> WOOL  <input type="radio"/> PROGRAM	<ul style="list-style-type: none"> <li>● Use this program for washing little dirty laundry within short time.</li> <li>● This program is economical due to short washing time.</li> <li>● Preset program : 6-minute wash, one rinse, 3-min spin.</li> </ul>
<b>SOAK</b> <input type="radio"/> FUZZY <input type="radio"/> ECONOMY <input checked="" type="radio"/> SOAK <input type="radio"/> WOOL  <input type="radio"/> PROGRAM	<ul style="list-style-type: none"> <li>● Use this program for washing terribly dirty laundry after soaking it in water.</li> <li>● This program provides the best washing effect.</li> <li>● Do not use this program for washing laundry easy to be discolored.</li> <li>● Preset program : 60-minute soaking, 12-minute wash, 2-rinse, 7-minute spin.</li> </ul>
<b>WOOL</b> <input type="radio"/> FUZZY <input type="radio"/> ECONOMY <input type="radio"/> SOAK <input checked="" type="radio"/> WOOL  <input type="radio"/> PROGRAM	<ul style="list-style-type: none"> <li>● Use this program for washing laundry woolen fabric.</li> <li>● Microcomputer controls the strength of current circulation.</li> <li>● Preset program : 6-minutes wash with mild current circulation, 2-rinse, 3-minute intermittent spin.</li> </ul>

**\* When you would like to change washing conditions, select them manually.**

**\* Preset programs mentioned above can be changed without notice.**



- FUZZY
- ECONOMY
- SOAK
- WOOL

Set the program indicator lamp. to [ECONOMY] by pressing program button.



(Initial State)

- FUZZY
- ECONOMY
- SOAK
- WOOL

Set the program indicator lamp. to [SOAK] by pressing program button.



- 99 is on the display when the time left is less than 100 minutes.



- FUZZY
- ECONOMY
- SOAK
- WOOL

Set the program indicator lamp. to [WOOL] by pressing program button.



- In this program hot water does not flow into the tub, and water level indicator lamp is always at L level.

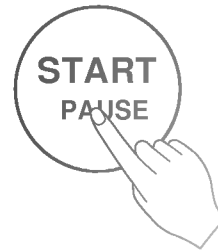

- After closing the lid press the START/PAUSE button.
- After washing finished pull out the plug.

- Take out laundry.
- Dry woolens in shade.
- Plug out the power plug.
- Lock the faucet.
- Clean the washing machine.

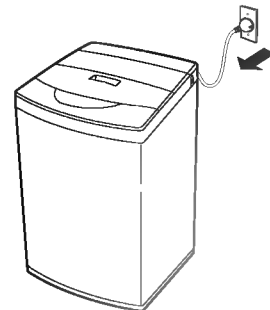

# RESERVATION WASHING PROGRAM

**1** Press the power button ON.

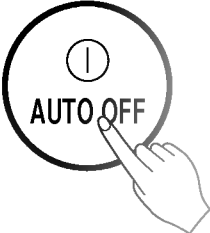



**2** Select program.

- FUZZY
- ECONOMY
- SOAK
- WOOL



- Select a desired Program.
- If not selected FUZZY program will be provided.
- \* The reservation for WOOL is not possible to prevent damage to laundry.

**3** Set the time.

- Select how many hours from now you would like your wash to finish.
- When you push the button the reservation time changes [3 → 4 → 5... → 12 → 14 → 16... → 48 → 3] repeatedly.

EX) It's 7 a.m. now. If you'd like your wash to finish at 9 p.m. set the time as in the figure below.

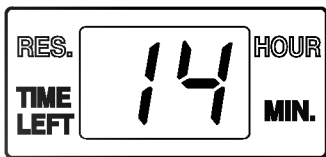

14 hours : 7 a.m.~9 p.m.

**4** Insert laundry and press the START/PAUSE button.

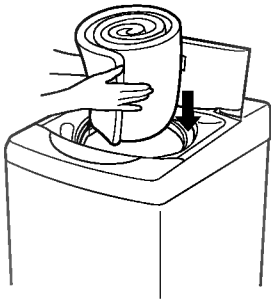

- Insert laundry and press the START/PAUSE button. The washer senses the amount of laundry and displays recommended amount of detergent.
- The washer does not sense the amount of laundry at WOOL program.

**5** Deposit detergent.

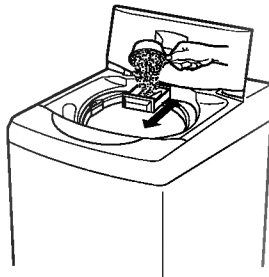

- Pull the detergent box forward and deposit displayed amount of detergent, then push back the box.
- Concentrated detergent is not suitable for RESERVATION WASHING.

**6** Close the lid.

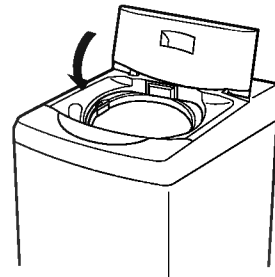

- If the lid is not completely closed, the machine generates an alarm sound.
- If the lid is opened RESERVATION WASHING can not proceed.

### CAUTION

- A wet detergent box may cause the detergent to clump together.
- Do not use powdered hand soap.  
If the lid is open, the machine will not operate and an error signal will sound.
- When you would like to cancel this program press the POWER button OFF.

# SELECTABLE WASHING METHODS

## ONLY WASHING

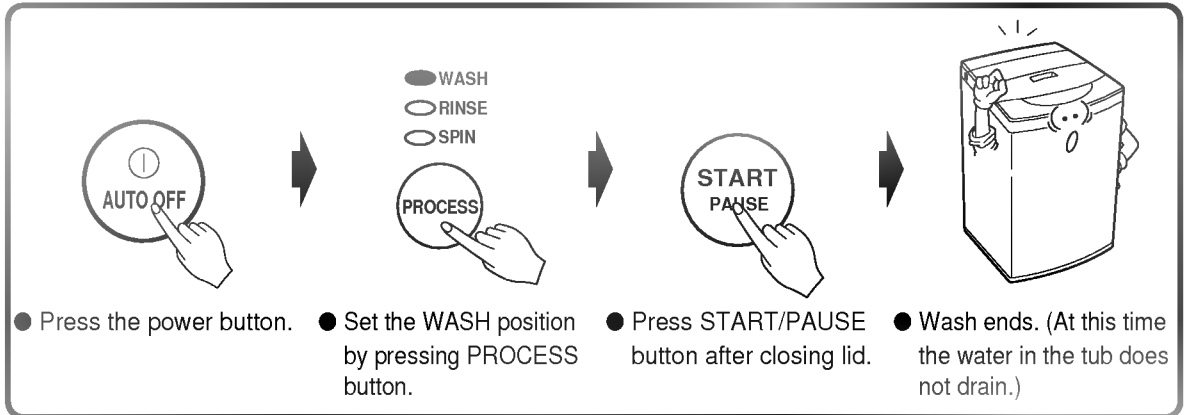

## ONLY RINSE

**!** If selecting "Rinse Only", insert Fabric Softener at the last cycle of rinsing.

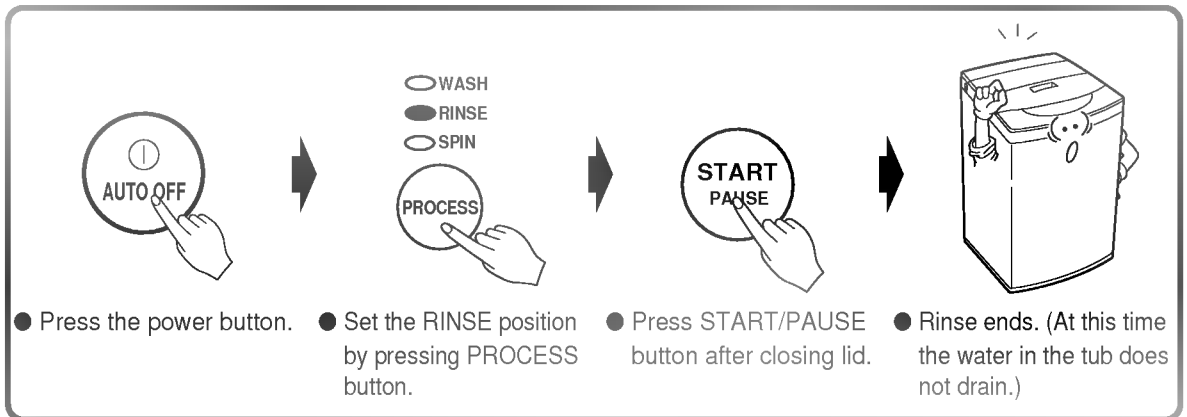

## ONLY SPIN

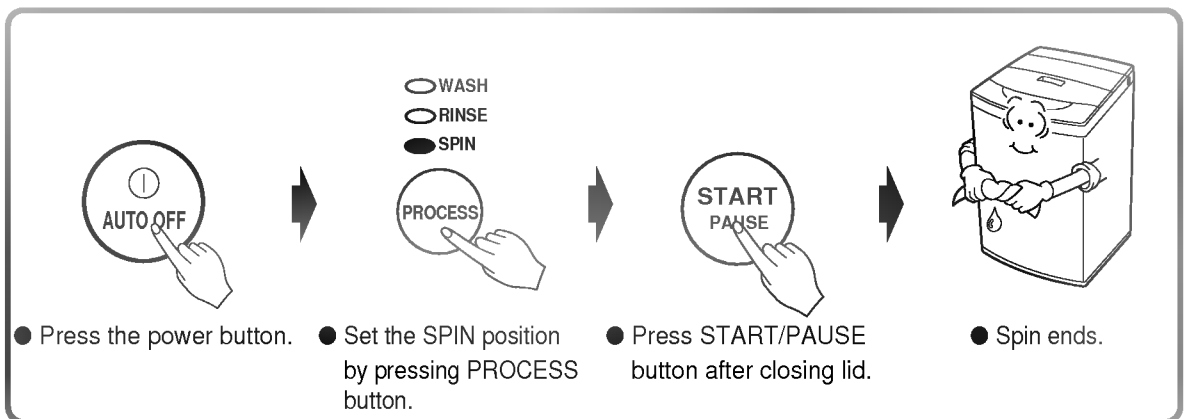

# MAINTENANCE

- **Clean the filter in the inlet valve.** When water supply into the tub is bad or the inlet valve is clogged with impurity.

- 1** Plug out the power cord from the outlet first.
- 2** Pull out the filter from the inlet valve with a tool.
- 3** Use a tooth brush to get rid of filth. Insert the filter.

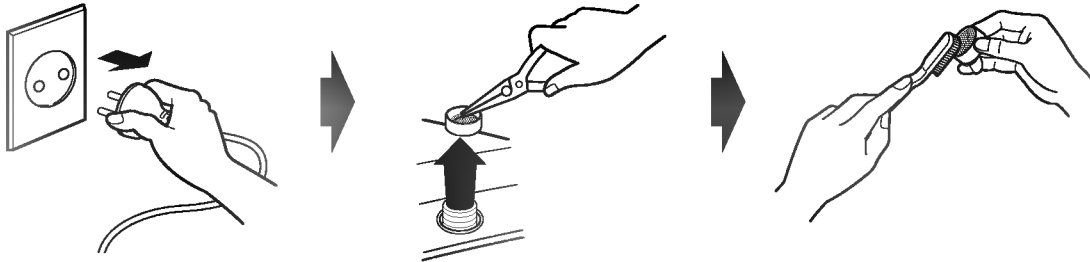

- **Clean the water thread collection net.**

- 1** Pull out the waste thread collection net from the tub like the arrow direction below.
- 2** Turn inside out to get rid of filth.
- 3** Insert it to the original location.

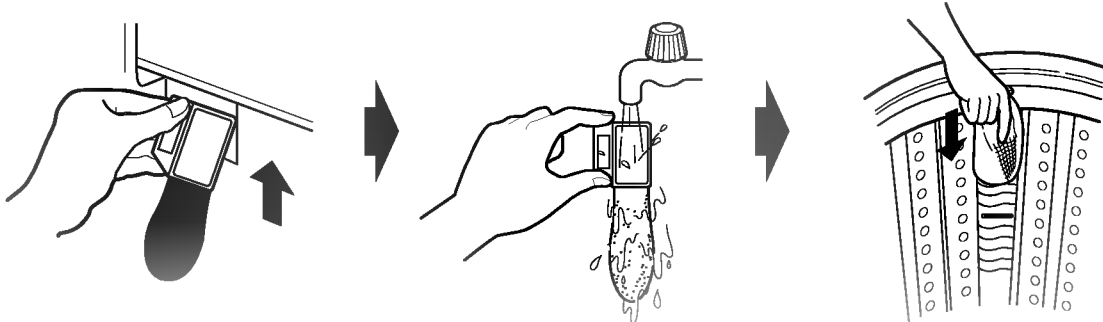

- **Clean the pump casing (when drainage is bad).**



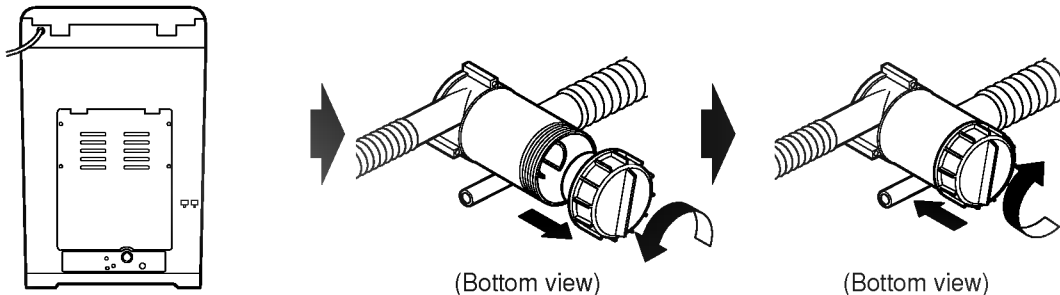



- 1** Unfasten 2 screws of the back cover.
- 2** Turn the cap to the arrow direction and unfasten it.
- 3** Reassemble the cap to the arrow direction and fasten it.

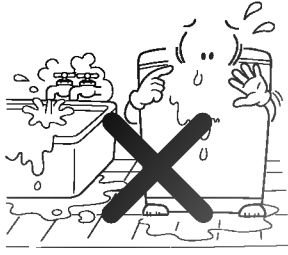

\* **CAUTION** : Check it over if water leaks after reassembling.(Rubber ring is in the cap)

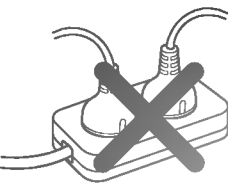
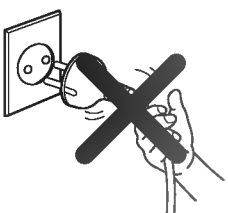
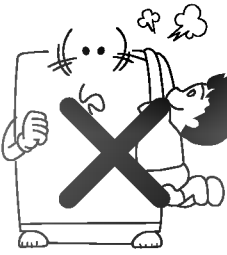
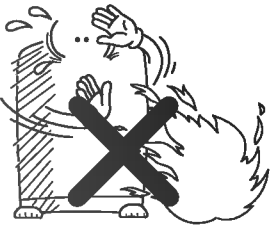

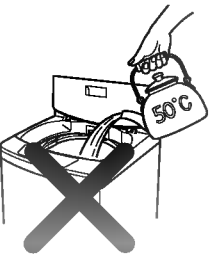
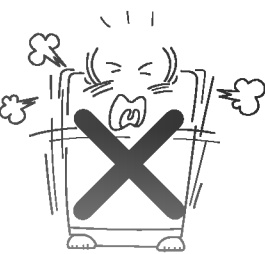

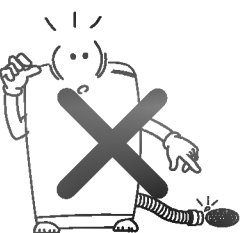

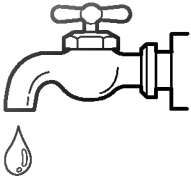
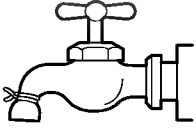
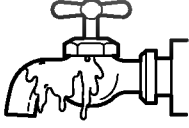

# GUIDANCES FOR SAFETY AND DURABILITY

□ Observe the following guidances for the durability of the washing machine and safety problems.

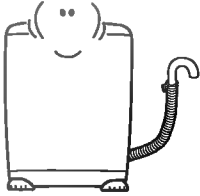
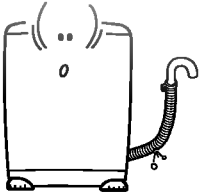
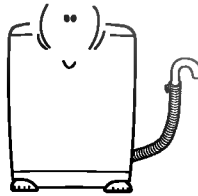
<ul style="list-style-type: none"> <li>● Do not expose the washing machine to a direct sunlight or rain.</li> </ul> 	<ul style="list-style-type: none"> <li>● Do not install the washing machine around a damp place.</li> </ul> 	<ul style="list-style-type: none"> <li>● Do not sprinkle water over buttons.</li> </ul> 
<ul style="list-style-type: none"> <li>● Do not plug many cords in one outlet at the same time.</li> </ul> 	<ul style="list-style-type: none"> <li>● When plugging out the power cord, do not hold the wire.</li> </ul> 	<ul style="list-style-type: none"> <li>● Have children stay away from the washing machine.</li> </ul> 
<ul style="list-style-type: none"> <li>● Keep the washing machine away from fire or heat source.</li> </ul> 	<ul style="list-style-type: none"> <li>● Do not pour caustic soda and bleach over the washing machine. It causes damage to rubber parts.</li> </ul> 	<ul style="list-style-type: none"> <li>● Do not pour over 50°C water into the tub</li> </ul> 
<ul style="list-style-type: none"> <li>● Make sure of closing the lid, In particular during spinning.</li> </ul> 	<ul style="list-style-type: none"> <li>● Do not put hands into the rotating tub.</li> </ul> 	<ul style="list-style-type: none"> <li>● Let water drain away from the drain hose thoroughly.</li> </ul> 

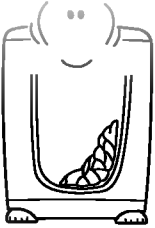

# TROUBLE-SHOOTING GUIDE

TROUBLES	CHECK UP		
<p>No water supply.</p> 	 <p>Is not the water faucet shut off?</p>	 <p>Is not the water supply cut off?</p>	 <p>Is not the faucet frozen?</p>
<p>No drain.</p> 	 <p>Check out if electric power goes off.</p>	 <p>Is not the drain hose frozen?</p>	 <p>Is the drain hose hung up properly? The proper height of stand pipes is 0.9~1.3m (For pump)</p>
<p>No spinning.</p> 	 <p>Is the laundry unevenly balanced?</p>		
<p>No spinning.</p> 	 <p>Is the lid closed?</p>		
<p>OTHERS</p>  	<p>ASK FOR SERVICE</p>		

# TROUBLE-SHOOTING GUIDE

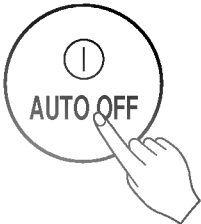
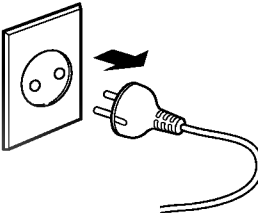
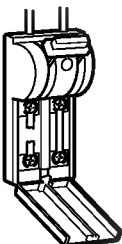
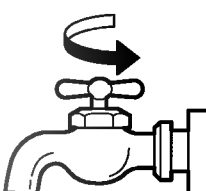
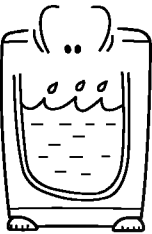
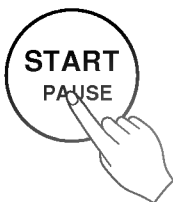
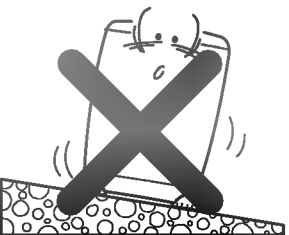
<p><b>No power.</b></p>	 <p>Is the power button pressed?</p>	 <p>Is the power cord unplugged?</p>	 <p>Power failure? Fuse blown?</p>
<p><b>No working.</b></p>	 <p>Is not the water faucet shut off?</p>	 <p>Is the water level normal?</p>	 <p>Has the START/PAUSE button been pressed?</p>
<p>The high level of vibration and noise during spinning.</p>	 <p>Is the washing machine installed on a level place?</p>		

# SPECIFICATION

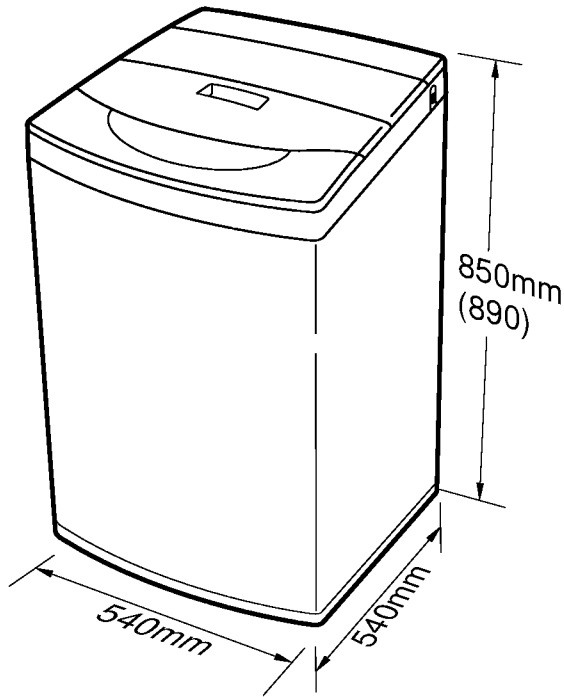

□ ELECTRICITY SOURCE	: ON THE RATING LABEL
□ THE USE RANGE OF WATER PRESSURE	: 0.3 - 10kgf/cm <sup>2</sup> (30 - 1000kPa)
□ MOTOR OUTPUT	: 90W
□ WEIGHT	: 32 kg
□ SIZE	: 540(W) × 540(D) × 850 or 890(H)
□ STANDARD WATER LEVEL	: EX-LARGE : 55 ℓ LARGE : 46 ℓ MEDIUM : 33 ℓ SMALL : 24 ℓ

\* The appearance and specifications may be varied without notices to raise unit quality.

\* The figure (890) is for WF-571(2) & 621(2)