



Colour Television

OWNER'S MANUAL

Please read this manual carefully before operating your set.
Retain it for future reference.
Record model number and serial number of the set.
See the label attached on the back cover and quote this
information to your dealer when you require service.

Model number :
Serial number :

P/NO : 3828 (MC84B, 008V, 029E TX)

Installation

Power

This set operates on an AC mains supply, the voltage is as indicated on the label on the back cover. Never apply DC power to the set. In the event of thunderstorms or powercuts, please pull out the aerial and mains plugs.

Warning

To prevent fire or shock hazard, do not expose the set to rain or moisture.

Service

Never remove the back cover of the set as this can expose you to very high voltage and other hazards. If the set does not operate properly, unplug it and call your dealer.

Aerial

Connect the aerial cable to the socket marked U on the back cover. For the best reception an outdoor aerial should be used.

Location

Position your set so that no bright light or sunlight falls directly onto the screen. Care should be taken not to expose the set to any unnecessary vibration, moisture, dust or heat. Also ensure that the set is placed in a position to allow a free flow of air. Do not cover the ventilation openings on the back cover.

Battery installation

The remote control handset is powered by two AA type batteries. To load the batteries, turn the handset over and slide open the battery compartment. Install two batteries as indicated by the polarity symbols(+ and -) marked inside the compartment. Here shown may be somewhat different from your set.

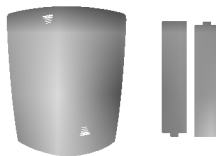

Note : To avoid damage from possible battery leakage, remove the batteries if you do not plan to use the remote control handset for an extended period of time.

Location and function of controls

Remote control handset

All the functions can be controlled with the remote control handset. Some functions can also be adjusted with the buttons on the front panel of the set.

Before you use the remote control handset, please install the batteries.

1. **POWER**
switches the set on from standby or off to standby.
2. **MUTE**
switches the sound on or off.
3. **NUMBER BUTTONS**
switch the set on from standby or directly select a number.
4. **MENU**
selects a menu.
5. **TURBO SOUND BUTTON**
selects Turbo sound.
6. **▲ (▲) / ▼ (▼) (Programme Up/Down)**
switches the set on from standby.
selects a programme or a menu item.
scans programmes automatically.
7. **☺ / ☹ (Volume Down/Up)**
adjusts the volume.
8. **⊖ / ⊕ (Volume Down/Up)**
adjusts the volume.
9. **OK**
accepts your selection or displays the current mode.
10. **EYE (option)**
switches the Eye function on or off.
11. **PSM (Picture Status Memory)**
recalls your preferred picture setting.
12. **VCR BUTTONS (option)**
control a LG/GoldStar video cassette recorder.
13. **TV/AV**
selects TV or AV mode.
clears the menu from the screen.
14. **ARC (Aspect Ratio Control)**
changes the picture format.
15. **TELETEXT BUTTONS (option)**
These buttons are used for teletext.
For further details, see the 'Teletext' section.
16. **TURBO PICTURE BUTTON**
selects Turbo picture.
17. **SSM (Sound Status Memory)-option**
recalls your preferred sound setting.
18. **I/II or DUAL/✳(option)**
selects the language during dual language broadcast.
selects the sound output.(option)

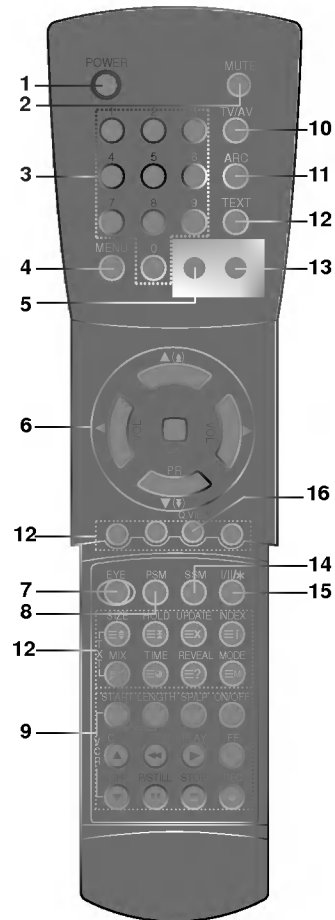

(With TELETEXT)

Location and function of controls

Front panel

Shown is a simplified representation of front panel. Here shown may be somewhat different from your set.

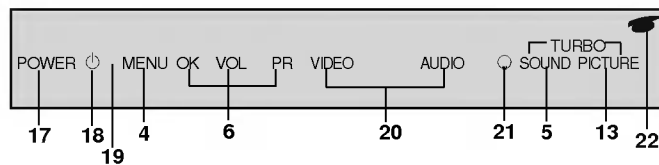
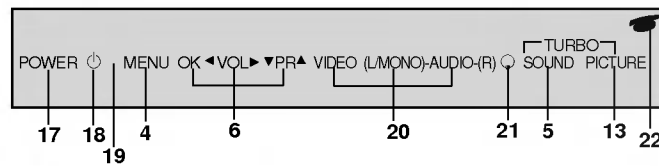
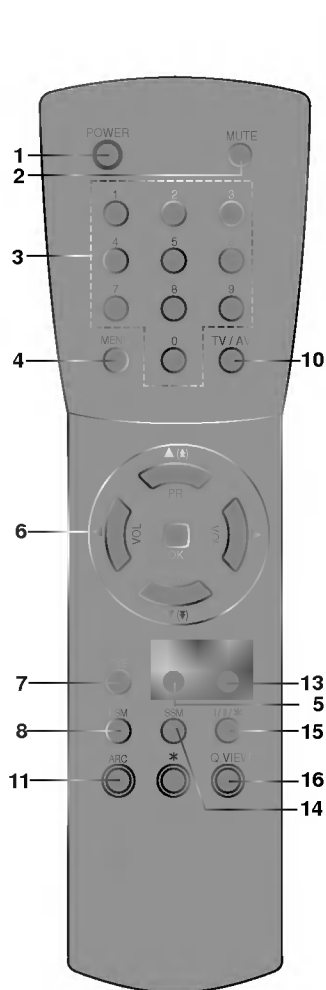

16. Q.VIEW

returns to the previously viewed programme..

17. MAIN POWER (POWER / \odot)

switches the set on or off.

18. POWER/STANDBY INDICATOR (\odot /stand-by)

illuminates brightly when the set is in standby mode.
dims when the set is switched on.

19. REMOTE CONTROL SENSOR

20. AUDIO/VIDEO IN SOCKETS (AV2) (option)

Connect the audio/video out sockets of external equipment to these sockets.

21. HEADPHONE SOCKET (option)

Connect the headphone plug to this socket.

22. EYE (option)

adjusts picture according to the surrounding conditions.

Note : Eye is an optional function. Only a set with the eye option can perform this function.

Note :

* : No function.

(Without TELETEXT)

Basic operation

On and off

1. Press the main power button to switch the set on.
2. If the set is in standby mode, press the **POWER**, **TV/AV** or **NUMBER** buttons on the remote control handset to switch it on fully.
3. Press the **POWER** button on the remote control handset. The set reverts to standby mode.
4. Press the main power button on the set again. It switches the set off and the power/standby indicator goes out in a few seconds.

Note : If, while the set is switched on, the mains plug is disconnected the set will switch to standby or power on when the mains plug is replaced in the mains power socket.

Programme selection

You can select a programme number with the **TV/AV** or **NUMBER** buttons.

Volume adjustment

Press the **VOL** button to adjust the volume.

Mute function

Press the **MUTE** button. The sound is switched off and the display  appears. You can cancel it by pressing the **MUTE**, **TV/AV**, **SSM**, **I/II** or **TURBO SOUND** button.

Quick view

Press the **Q.VIEW** button to view the last programme you were watching.

Auto Demonstration

To review all the menus programmed in the set, press the **OK** button of the front panel control for about 5 seconds. To stop auto demonstration, press any button of the front panel control and **POWER** button of the remote control.

On screen language selection (option)

This is an optional function. The menu can be displayed on the screen in the desired language. First select your language.

1. Press the **MENU** button to display MENU 1.
2. Press the **TV/AV** button to select **LANGUAGE**.
3. Press the **OK** button to display the sub menu.
4. Press the **TV/AV** or **TV/AV** button to select the desired language.
5. Press the **OK** button.
6. All the on screen displays will appear in the selected language.
6. Press the **TV/AV** button to return to normal TV viewing.

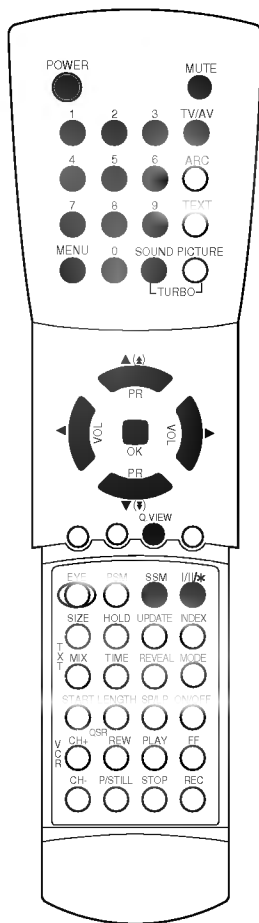



On screen menus

The dialogue between you and your set takes place on screen with an operator menu. The buttons required for the operating steps are also displayed.

Menu selection

1. Press the **MENU** button to display each menu.
2. Press the **▲/▼** button to select a menu item.
3. The selected menu item changes from green to purple.
4. Press the **◀/▶** button to change the setting of a menu item or **OK** button to display the sub menu.

Note :

- a. The menus automatically disappear in about 1 minute if you do not press a button.
- b. In the AV mode, MENU 1 is not displayed.
- c. In the teletext mode, menus are not displayed.
- d. In the MENU 2, the display **●●●●●●●●** appears at the bottom of the menu if the eye function is on.
- e. In mono models, MENU 3 does not appear.
- f. In some models, the menu items **AUTO AV, LANGUAGE, SYSTEM** and **GAME** are not displayed on the screen menu.
- g.  or  signify that icons appear when Turbo picture or Turbo sound function is on.

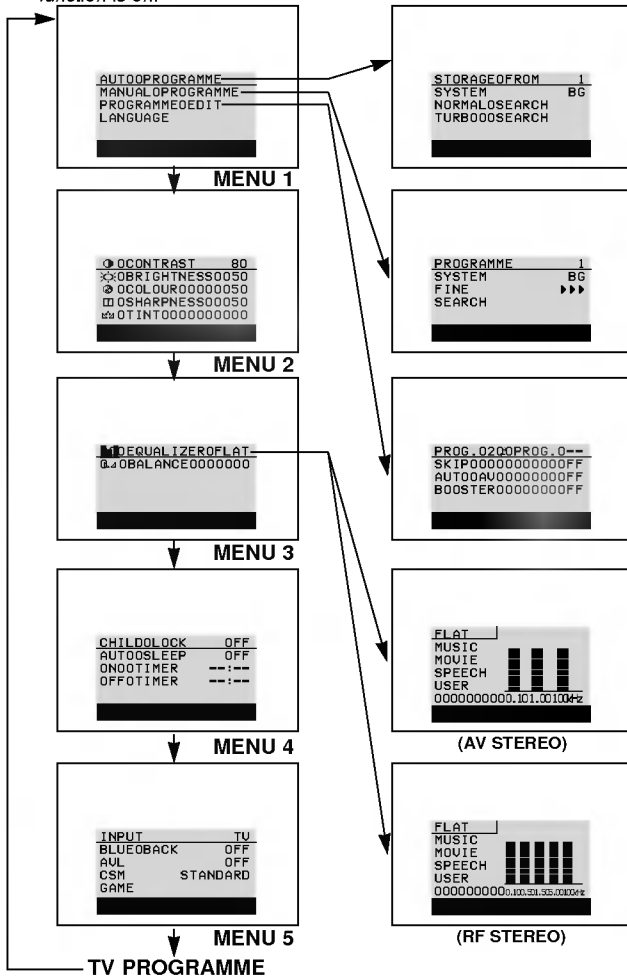
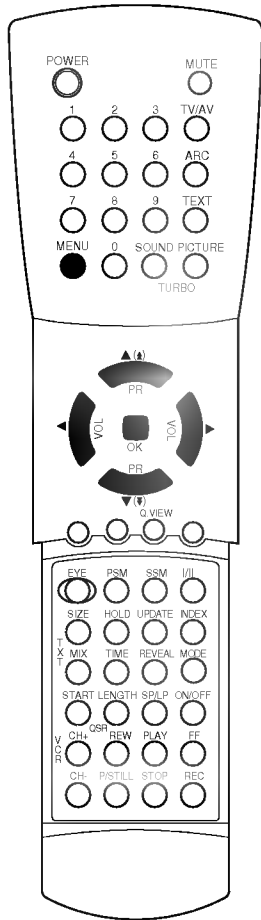

Setting up TV stations

MENU 1



Up to 100 TV stations can be stored in this set by programme numbers (00 to 99). Once you have preset the stations, you will be able to use the $\bar{\Delta}$ / $\bar{\nabla}$ or NUMBER buttons to scan the stations you programmed. Stations can be tuned using automatic or manual modes.

SYSTEM is an optional function.

Auto programme tuning

All stations that can be received are stored by this method. It is recommended that you use auto programme during installation of this set.

1. Press the **MENU** button to display MENU 1.
2. Press the $\bar{\Delta}$ / $\bar{\nabla}$ button to select **AUTO PROGRAMME**.
3. Press the **OK** button to display the **AUTO PROGRAMME** menu.

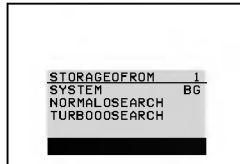
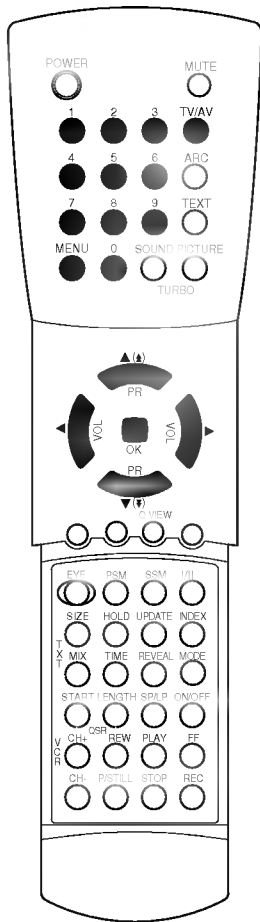

4. Press the $\bar{\Delta}$ / $\bar{\nabla}$ button to select **STORAGE FROM**. Select the beginning programme number with the \bar{c} / \bar{c}° button or NUMBER buttons. Any number under 10 is entered with a numeric '0' in front of it, i.e. '05' for 5.
5. Press the $\bar{\Delta}$ / $\bar{\nabla}$ button to select **SYSTEM**. Select a TV system with the \bar{c} / \bar{c}° button; **BG** (Asia/New Zealand/M.East/Africa), **I** (Hong Kong/South Africa), **DK** (East Europe/China/Africa/CIS) or **M** (USA/Korea/Philippines).

Option:

6. Press the $\bar{\Delta}$ / $\bar{\nabla}$ button to select **NORMAL SEARCH** or **TURBO SEARCH**.

Note :

- a. **TURBO SEARCH** is further faster than **NORMAL SEARCH** and in some models, **NORMAL SEARCH** will automatically store all receivable stations. **TURBO SEARCH** is faster but will store them in the system selected.
 - b. If the programmed station has poor quality sound, select the system again in the **MANUAL PROGRAMME** menu.
7. Press the **OK** button to begin auto programming.

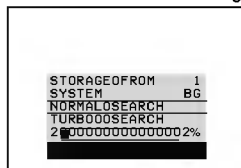

(Normal search)

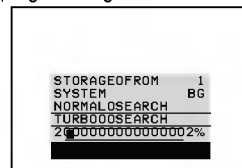

(Turbo search)

All receivable stations are stored.

To stop auto programming, press the **MENU** button.

When auto programming is completed, the **PROGRAMME EDIT** menu appears on the screen. See the 'Programme edit' section to edit the stored programme.

8. Press the **TV/AV** button to return to normal TV viewing.

Programme scan

To automatically scan the pictures of stored programmes, press the \blacktriangle (\blacktriangle) or \blacktriangledown (\blacktriangledown) button for about 3 seconds. The picture of stored programmes appears on the screen one by one.

To stop auto programme scanning, press any button except VCR buttons.

Setting up TV stations

Manual programme tuning

Manual programme let you manually tune and arrange the station in whatever order you desire.

1. Press the **MENU** button to display MENU 1.
2. Press the $\bar{\wedge}/\bar{\wedge}$ button to select **MANUAL PROGRAMME**.
3. Press the **OK** button to display the **MANUAL PROGRAMME** menu.



MENU 1

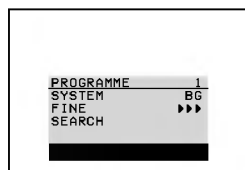

4. Press the $\bar{\wedge}/\bar{\wedge}$ button to select **PROGRAMME**. Select the desired programme number with the \bar{c}/\bar{c}^9 button or NUMBER buttons. Any number under 10 is entered with a numeric '0' in front of it, i.e. '05' for 5.
5. Press the $\bar{\wedge}/\bar{\wedge}$ button to select **SYSTEM**. Select a TV system with the \bar{c}/\bar{c}^9 button; **BG**(Asia/New Zealand/M.East/Africa), **I** (Hong Kong/South Africa), **DK**(East Europe/China/Africa/CIS) or **M**(USA/Korea/Philippines).
Option:
In some models, the menu item **SYSTEM** is not displayed on the screen, so that there is no necessity for selecting it at that time.
6. Press the $\bar{\wedge}/\bar{\wedge}$ button to select **SEARCH**.
7. Press the \bar{c}/\bar{c}^9 button to commence searching. If a station is found the search will stop.
8. Press the **OK** button. The display **STORED** will appear.
9. To store another station repeat steps 4 to 8.
10. Press the **TV/AV** button to return to normal TV viewing.

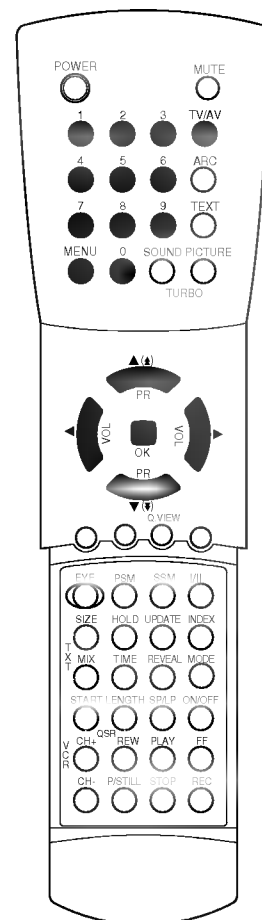

Fine tuning

Normally fine tuning is only necessary if reception is poor.

1. Repeat 'Manual programme tuning' steps 1 to 3.
2. Press the $\bar{\wedge}/\bar{\wedge}$ button to select **FINE**.
3. Press the \bar{c}/\bar{c}^9 button to fine tune for the best picture and sound.
4. Press the **OK** button. The display **STORED** will appear.
5. Press the **TV/AV** button to return to normal TV viewing.
The finely tuned programme will be indicated by yellow number during programme selection.

Programme edit

This function enables you to rearrange the programmes stored by auto programming in whatever order you desire. Also you can skip particular programme numbers stored by auto programming.

1. Press the **MENU** button to display MENU 1.
2. Press the $\bar{\wedge}/\bar{\wedge}$ button to select **PROGRAMME EDIT**.

Setting up TV stations

MENU 1



3. Press the OK button to display the **PROGRAMME EDIT** menu.

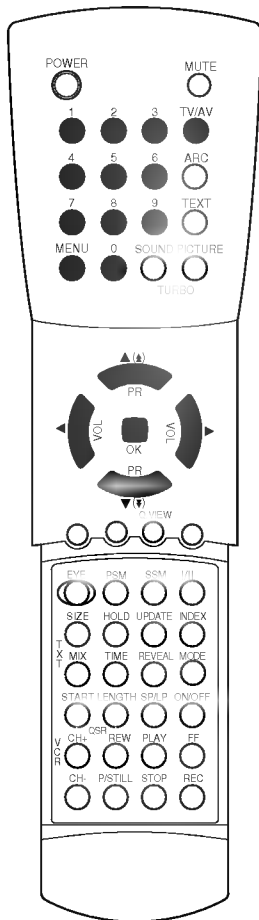
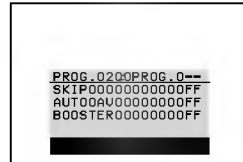

Exchanging programmes

1. Press the c/c^9 button to change the left hand programme number. The viewing station corresponding to the new programme number is shown on the screen.
2. Press the NUMBER buttons to enter the desired right hand programme number. Any number under 10 is entered with a numeric '0' in front of it, i.e. '05' for 5.
3. Press the OK button. The station stored in the right hand programme number will now appear as the left hand programme number.
4. Repeat steps 1 to 3 to exchange other programmes.

Skipping a stored programme

1. Press the c/c^9 button to select the programme you want to skip. The viewing station corresponding to the selected programme number is shown on the screen.
2. Press the $\text{j}/\text{a}/\text{j}/\text{a}$ button to select **SKIP**.
3. Press the c/c^9 button to select **ON** or **OFF**. If you select **ON**, the selected station is skipped.
4. Press the OK button. The display **STORED** will appear.
5. Repeat steps 1 to 4 to skip another programme. The selection of the skipped programme numbers with the NUMBER buttons is still possible and they will be indicated by cyan numbers during programme selection.

Note : The programme number 1 cannot be skipped.

Auto AV setting (option)

Auto AV is an optional function.

If your VCR outputs a switching voltage when it is switched to playback, select **AUTO AV ON** with the VCR connected to Euro scart. The set is automatically switched to AV1 mode when an AV signal is input. But if you want to keep on watching TV mode, set **AUTO AV to OFF**.

1. Press the c/c^9 button to select your desired programme number.
2. Press the $\text{j}/\text{a}/\text{j}/\text{a}$ button to select **AUTO AV**.
3. Press the c/c^9 button to select **ON** or **OFF**.
4. Press the OK button. The display **STORED** will appear.
5. Repeat steps 1 to 4 to set another programme.

Booster (option)

In some models, **BOOSTER** is an optional function. Only a set with **BOOSTER** can perform this function.

If the reception is poor at the fringe area of TV signal, select **BOOSTER to ON**. When the picture condition is good, do not select **BOOSTER to ON**.

1. Press the c/c^9 button to select your desired programme number.
2. Press the $\text{j}/\text{a}/\text{j}/\text{a}$ button to select **BOOSTER**.
3. Press the c/c^9 button to select **ON** or **OFF**.
4. Press the OK button. The display **STORED** will appear.
5. Repeat steps 1 to 4 to set another programme.

Press the TV/AV button to return to normal TV viewing.

Picture adjustment

MENU 2

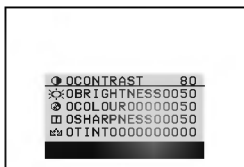

Picture adjustment

You can adjust picture contrast, brightness, colour intensity, sharpness and tint(NTSC input only) to the levels you prefer.

1. Press the **MENU** button to display MENU 2.
2. Press the **↑/↓** button to select the desired picture item.
3. Press the **←/→** button to make appropriate adjustments.
4. Press the **OK** button. The display **STORED** will appear.

To recall your preferred setting, press the **PSM** button until the desired picture (**STANDARD**, **USER**, **DYNAMIC**, **MILD** or **GAME**) appears. **STANDARD**, **DYNAMIC**, **MILD** and **GAME** are programmed at the factory for good picture reproduction appropriate to each programme character and cannot be changed.
Note : If you press the **PSM** button after making appropriate adjustment in MENU 2, the display **USER** automatically appears even though you have already set a factory preset setting; **STANDARD**, **DYNAMIC**, **MILD** or **GAME**.

Eye (option)

Eye is an optional function.

This set will automatically adjust the picture according to the surrounding conditions. This will enable you to enjoy the most suitable picture according to the surroundings.

Press the **EYE** button to switch the eye function on or off.



When the eye function is on, the most suitable picture automatically is adjusted according to the surrounding conditions. At this time the display ********* in green does not appear continuously but the display ********* in yellow appears each time the picture condition changes.

Note : If you press the **PSM** button with the eye function, the eye function is automatically switched off.

Picture format selection

You can watch the TV in three picture formats; **STANDARD**, **WIDE** and **ZOOM**.

Press the **ARC** (Aspect Ratio Control) button to switch to **STANDARD**, **WIDE** or **ZOOM** picture format.

STANDARD (4:3)

This is the normal picture size 4 by 3 as displayed on all TV sets.

WIDE (16:9)

This is the cinema screen picture format. Some TV stations broadcast in this picture format. To receive the picture size 16 by 9, select **WIDE**.

ZOOM

This is the picture format the **STANDARD** picture is magnified vertically. The extreme top and bottom of the picture may be lost.

Note :

- When you switch the set to standby or off, the **WIDE** or **ZOOM** picture format is reset to the **STANDARD** (4:3).
- In the AV mode, **WIDE** picture format is not available.

Turbo picture selection(option)

When this function is on, picture will be more brilliant and distinct picture than normal picture. You can enjoy the Turbo picture is so much the better than normal picture.

Repeatedly press the **TURBO PICTURE** button to switch on or off.



(Turbo Picture on)

(Turbo Picture off)

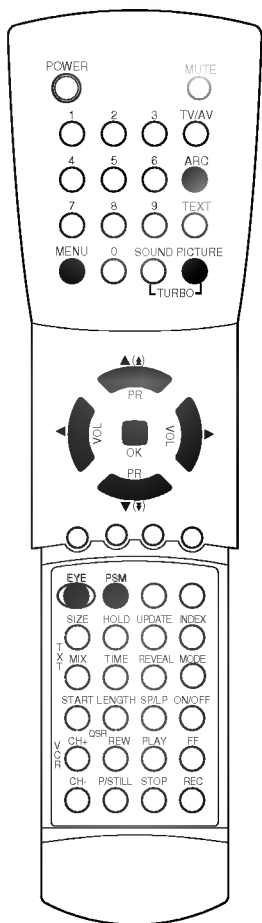

Sound adjustment (option)

MENU 3



Sound adjustment (option)

This is an optional function (Mono model is not available). You can select your preferred sound setting; Flat, Music, Movie or Speech as you prefer. Also you can adjust the sound frequency to the levels you prefer. The surround sound creates an all around sound as in a concert hall.

1. Press the **MENU** button to display MENU 3.
2. Press the \uparrow/\downarrow button to select the desired sound item; **EQUALIZER** or **BALANCE**.
3. Press the \leftarrow/\rightarrow button to make desired adjustment.

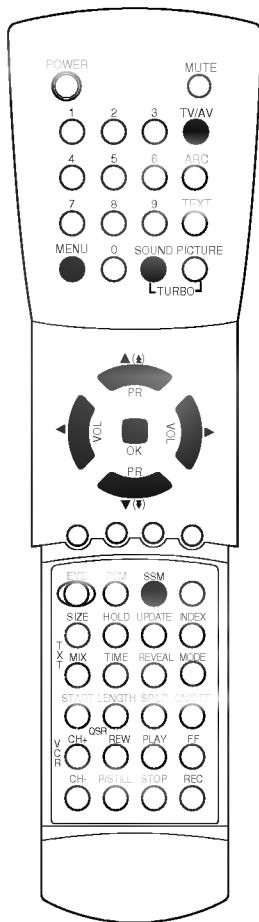

EQUALIZER

Select **FLAT**, **MUSIC**, **MOVIE**, **SPEECH** or **USER** by pressing the \uparrow/\downarrow button.

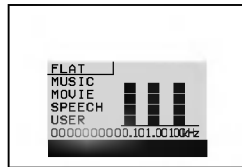

(AV STEREO, FLAT)

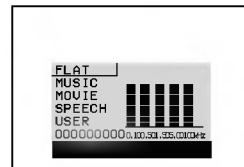

(RF STEREO, FLAT)

In case of **FLAT**, **MUSIC**, **MOVIE**, **SPEECH** each corresponding equalizer is displayed on the screen. **FLAT**, **MUSIC**, **MOVIE**, **SPEECH** are programmed at the factory for good sound reproduction appropriate to each programme character.

In case of **USER**, select the sound band with the \leftarrow/\rightarrow button and make appropriate sound level with the \uparrow/\downarrow button as you prefer. Press the **OK** button and the display **STORED** will appear.

BALANCE

Adjust the balance level by pressing the \leftarrow/\rightarrow button.

4. Press the **TV/AV** button to return to normal TV viewing.

To recall your preferred setting, press the **SSM** button until the desired sound (**FLAT**, **MUSIC**, **MOVIE**, **SPEECH** or **USER**) appears. **FLAT**, **MUSIC**, **MOVIE** and **SPEECH** are programmed at the factory for good sound reproduction appropriate to each programme character and cannot be changed.

Note : If you press the **SSM** button after making appropriate adjustment in MENU 3, the display **USER** automatically appears even though you have already set a factory preset setting; **FLAT**, **MUSIC**, **MOVIE** or **SPEECH**.

Turbo sound selection(option)

When this function is on, sound will be more emphasized and amplified sound than normal sound. You can enjoy the Turbo Sound is so much the better than normal Sound. Repeatedly press the **TURBO SOUND** button to switch on or off.

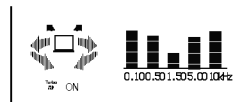

(Turbo Sound on)

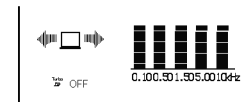

(Turbo Sound off)

Sound adjustment (option)

Stereo/Dual reception (option)

Stereo/dual is an optional function.

When a programme is selected, the sound information for the station appears after the programme number disappears.

Broadcast	On Screen Display
Mono	MONO
Stereo	STEREO
Dual	DUAL I

Mono sound selection

In stereo reception if the stereo signal is weak, you can switch to mono by pressing the **I/II/✳** or **DUAL/✳** button. In mono reception the depth of sound is improved. To switch back to stereo, press the **I/II/✳** or **DUAL/✳** button again.

Language selection for dual language broadcast

If a programme received in two languages (dual language), you can switch to **DUAL I**, **DUAL II** or **DUAL I+II** (option) by pressing the **I/II/✳** or **DUAL/✳** button repeatedly.

DUAL I sends the primary broadcast language to the loudspeakers.
DUAL II sends the secondary broadcast language to the loudspeakers.

DUAL I+II sends a separate language to each loudspeaker.(option)

NICAM reception (option)

NICAM (Near Instantaneous Companding Audio Multiplex) is an optional function.

If your set is equipped with the receiver for NICAM reception, the high quality NICAM (Near Instantaneous Companding Audio Multiplex) digital sound can be received.

Sound output can be selected according to the type of received broadcast as follows by pressing the **I/II/✳** or **DUAL/✳** button repeatedly.

1. When NICAM mono is received, you can select **NICAM MONO** or FM MONO.
2. When NICAM stereo is received, you can select **NICAM STEREO** or FM MONO. If the stereo signal is weak, switch to FM MONO.
3. When NICAM dual is received, you can select **DUAL I**, **DUAL II** or **DUAL I+II** or **MONO**. When FM mono is selected the display **MONO** appears on the screen.

Sound output selection (option)

This is an optional function.

In AV mode, you can select output sound for the left and right loudspeakers.

Repeatedly press the **I/II/✳** or **DUAL/✳** button to select the sound output.

L+R : Audio signal from audio L input is sent to left loudspeaker and audio signal from audio R input is sent to right loud-speaker.

L+L : Audio signal from audio L input is sent to left and right loudspeakers.

R+R : Audio signal from audio R input is sent to left and right loudspeakers.

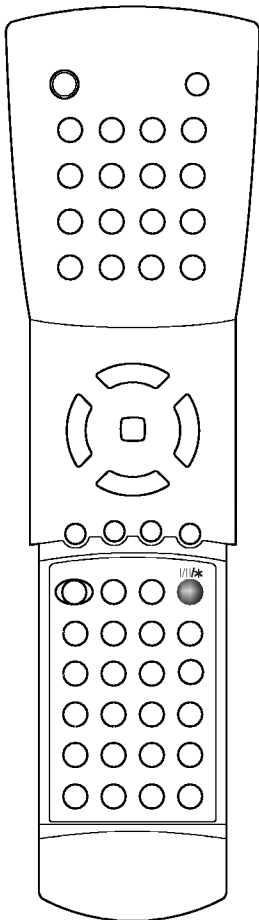

Other functions

Child lock

The TV can be set so that the remote control handset is needed to control it. This feature can be used to prevent unauthorised viewing.

1. Press the **MENU** button to display MENU 4.
2. Press the $\bar{\imath}/\tilde{\imath}/\hat{\imath}$ button to select **CHILD LOCK**.
3. Press the $\mathring{c}/\mathring{c}^{\circ}$ button on the remote control handset to select **ON**.
4. Press the **OK** or **TV/AV** button to return to normal TV viewing.

With the lock on, the display **CHILD LOCK ON** appears on the screen if any button on the front panel is pressed while viewing the TV.

Auto sleep

If you select **AUTO SLEEP ON** the set will automatically switch itself to standby mode approximately ten minutes after a TV station stops broadcasting.

1. Press the **MENU** button to display MENU 4.
2. Press the $\bar{\imath}/\tilde{\imath}/\hat{\imath}$ button to select **AUTO SLEEP**.
3. Press the $\mathring{c}/\mathring{c}^{\circ}$ button to select **ON**.
4. Press the **OK** or **TV/AV** button to return to normal TV viewing.

On timer

The set automatically switches on after the preset time elapses.

1. Press the **MENU** button to display MENU 4.
2. Press the $\bar{\imath}/\tilde{\imath}/\hat{\imath}$ button to select **ON TIMER**.
3. Set the desired time period with the $\mathring{c}/\mathring{c}^{\circ}$ button.
4. Press the **OK** or **TV/AV** button to return to normal TV viewing.

Off timer

The off timer automatically switches the set to standby after the pre-set time elapses.

1. Press the **MENU** button to display MENU 4.
2. Press the $\bar{\imath}/\tilde{\imath}/\hat{\imath}$ button to select **OFF TIMER**.
3. Set the desired time period with the $\mathring{c}/\mathring{c}^{\circ}$ button.
4. Press the **OK** or **TV/AV** button to return to normal TV viewing.

You can set the on/off timer from 10 minutes up to 12 hours 50 minutes in 10 minutes steps. The timer begins to count down from the selected time period.

Note :

- a. This set must be put into standby mode with the **POWER** button on the remote control to operate the on timer function.
- b. Two hours after the set is switched on by the on timer function it will automatically switch back to standby mode unless a button has been pressed.
- c. To view the remaining on/off time, select MENU 4.
- d. To cancel the set on/off time, set the on/off timer to —:—.
- e. When you switch the main power off, the on/off time is reset.

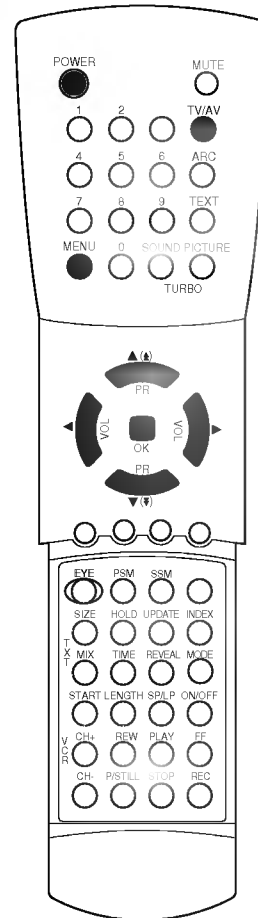
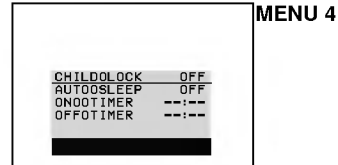

Other functions

MENU 5

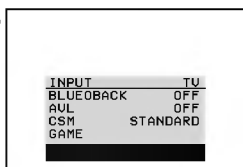

TV and AV modes

Inputs can be set for TV or AV mode. AV mode is used when a video cassette recorder (VCR), or other equipment is connected to the set.

Note : When a VCR is connected via the aerial socket the set is used in TV mode. See the 'Connection of external equipment' section.

1. Press the **MENU** button to display MENU 5.
2. Press the $\bar{i} \tilde{a} / \hat{a}$ button to select **INPUT**.
3. Press the $\mathcal{C}_s / \mathcal{C}^o$ button to select **TV, AV 1** or **AV 2**.

The two AV modes are :

AV 1 : VCR connected to the Euro scart socket or phone jack on the back

AV 2 : VCR connected to the **AV2** sockets on the front panel (option)

4. Press the **TV/AV** button.

To return to TV mode from AV mode press the $\bar{i} \tilde{a} / \hat{a}$, **TV/AV** or **NUMBER** buttons.

Alternatively you can select the TV or AV mode by pressing the **TV/AV** button.

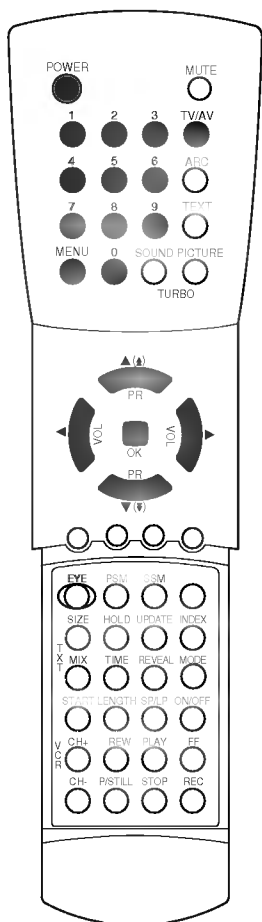

Blue back

If you have set **BLUE BACK ON**, the blue background appears on the screen when there is no broadcasting signal.

1. Press the **MENU** button to display MENU 5.
2. Press the $\bar{i} \tilde{a} / \hat{a}$ button to select **BLUE BACK**.
3. Press the $\mathcal{C}_s / \mathcal{C}^o$ button to select **ON** or **OFF**.
4. Press the **TV/AV** button to return to normal TV viewing.

AVL (Auto Volume Leveler)

AVL automatically keeps on an equal volume level even if you change programmes.

1. Press the **MENU** button to display MENU 5.
2. Press the $\bar{i} \tilde{a} / \hat{a}$ button to select **AVL**.
3. Press the $\mathcal{C}_s / \mathcal{C}^o$ button to select **ON** or **OFF**.
4. Press the **TV/AV** button to return to normal TV viewing.

Other functions

MENU 5

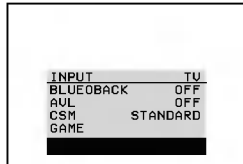

CSM (Colour Status Memory)

You can select the picture colour status; standard, reddish, greenish or bluish, as you prefer.

1. Press the **MENU** button to display MENU 5.
2. Press the \uparrow/\downarrow button to select **CSM**.
3. Press the \leftarrow/\rightarrow button to select **STANDARD, REDDISH, GREENISH** or **BLUISH**.
4. Press the **TV/AV** button to return to normal TV viewing.

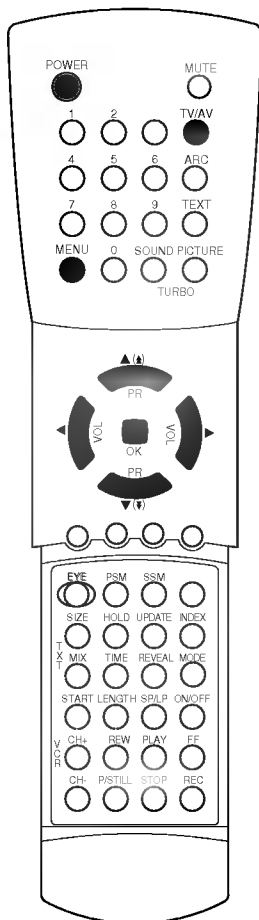

TV game (option)

This is an optional function.

You can enjoy the TV game with this set. To make a good score, try to remove insect come down from above with \leftarrow/\rightarrow , \uparrow/\downarrow button.

1. Press the **MENU** button to display MENU 5.
2. Press the \uparrow/\downarrow button to select **GAME**.
3. Press the **OK** button to start game. Move gun to left and right with the \leftarrow/\rightarrow button, and adjust direction of gun with the \uparrow/\downarrow button, and shoot a gun with **OK** button when playing the game. The game score will automatically be displayed.

Remote control for Game(option)

This remote control is optional supply.

If it's supplied to you, use it when playing the game.



Power : switches the set on from stand-by or off to standby
Mute : switches the sound on or off
TV/AV : exit game mode
MENU : display game menu and exit game mode
PR \uparrow/\downarrow /VOL \leftarrow/\rightarrow /OK \blacksquare : control or shoot a gun when playing the game

Note :

- a. If you want to exit this mode while the game is being played, press the **TV/AV** or **MENU** button.
- b. If you want to continue the game, press the **OK** button to start.

Teletext (option)

Teletext is an optional function, therefore only a set with the teletext system can receive the teletext broadcast.

Teletext is a free service broadcast by most TV stations which gives up-to-the-minute information on news, weather, television programmes, share prices and many other topics.

The teletext decoder of this TV can support the SIMPLE, TOP and FASTEXT systems. SIMPLE (standard teletext) consists of a number of pages which are selected by directly entering the corresponding page number. TOP and FASTEXT are more modern methods allowing quick and easy selection of teletext information.

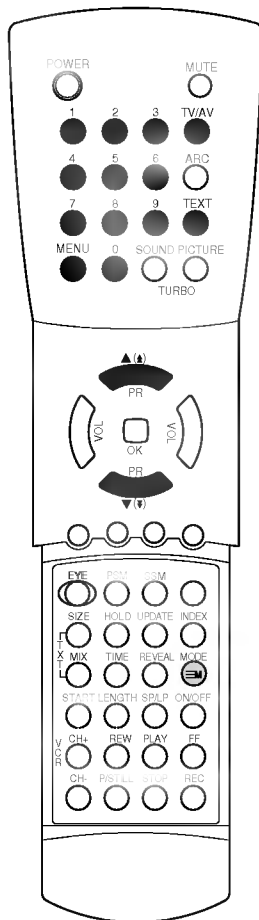

Switch on/off

Press the **TEXT** button to switch to teletext. The initial page or last selected page appears on the screen.

Two page numbers, TV station name, date and time are displayed on the screen headline. The first page number indicates your selection, while the second shows the current page displayed.

Press the **TEXT** or **TV/AV** button to switch off teletext. The previous mode reappears.

SIMPLE text

If the TV is in Simple text, TOP text or FASTEXT, press the **MODE** button to switch to LIST mode.

Page selection

1. Enter the desired page number as a three digit number with the **NUMBER** buttons. If during selection you press a wrong number, you must complete the three digit number and then re-enter the correct page number.
2. The **UP**/**DOWN** button can be used to select the preceding or following page.

Teletext (option)

LIST mode

Programming a colour button

Four teletext page numbers of your choice can be colour coded and easily selected by pressing the corresponding coloured button on the remote control handset.

1. Using the NUMBER buttons, select the page you wish to programme.
2. Wait until the page is displayed on the screen and press the **OK** button. The page numbers in the colour boxes along the bottom of the screen change to "000?".
3. Press a colour button to store the page number. From now on, you can select this page with the same coloured button.
4. The three other coloured buttons are programmed in the same way.

TOP text

The user guide displays four fields-red, green, yellow and blue at the bottom of the screen. The yellow field denotes the next group and the blue field indicates the next block.

Group/block/page selection

1. With the blue button you can progress from block to block.
2. Use the yellow button to proceed to the next group with automatic overflow to the next block.
3. With the green button you can proceed to the next existing page with automatic overflow to the next group. Alternatively the \uparrow/\downarrow button can be used.
4. The red button permits to return to previous selection. Alternatively the \leftarrow/\rightarrow button can be used.

Direct page selection

Corresponding to the SIMPLE teletext mode, you can select a page by entering it as a three digit number using the NUMBER buttons in TOP mode.

FASTEXT

The teletext pages are colour coded along the bottom of the screen and are selected by pressing the corresponding coloured button.

Page selection

1. Press the **INDEX** button to select the index page.
2. You can select the pages which are colour coded along the bottom line with the same coloured buttons.
3. Corresponding to the SIMPLE teletext mode, you can select a page by entering its three digit page number with the NUMBER buttons in FASTEXT mode.
4. The \uparrow/\downarrow button can be used to select the preceding or following page.

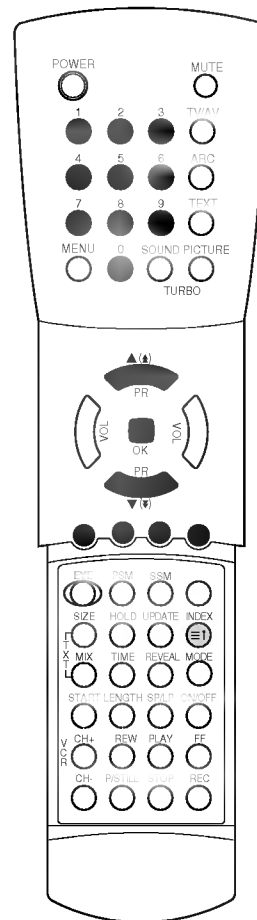

Teletext (option)

Special teletext functions

REVEAL

Press this button to display concealed information, such as solutions of riddles or puzzles.

Press this button again to remove the information from the display.

EXPAND (SIZE)





Selects double height text.

Press this button to enlarge the top half of the page.

Press this button again to enlarge the bottom half of the page.

Press this button again to return to the normal display.

UPDATE

Displays the TV picture on the screen while waiting for the new teletext page. The display  or  will appear at the top left hand corner of the screen. When the updated page is available then display  or  will change to the page number.

Press this button to view the updated teletext page.

HOLD (STOP)

Stops the automatic page change which will occur if a teletext page consists of 2 or more sub pages. The number of sub pages and the sub page displayed is, usually, shown on the screen below the time. When this button is pressed the stop symbol is displayed at the top left-hand corner of the screen and the automatic page change is inhibited.

To continue press this button again.

MIX

Displays the teletext pages superimposed on the TV picture.

To switch the TV picture off press this button again.

TIME

When viewing a TV programme, press this button to display the time at the top right hand corner of the screen. Press this button again to remove the display. In the teletext mode, press this button to select a sub page number. The sub page number is displayed at the bottom of the screen. To hold or change the sub page, press the RED/GREEN,  or NUMBER buttons. Press again to exit this function.

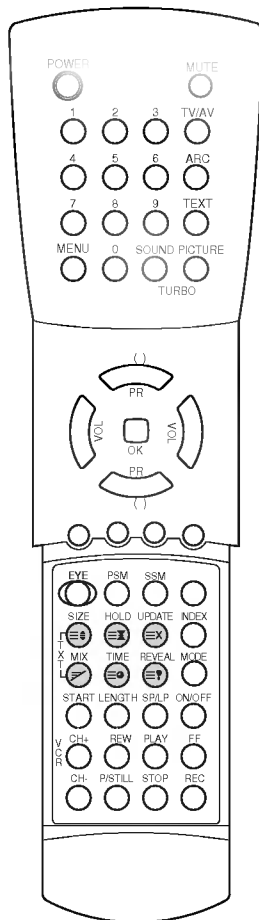

Connection of external equipment

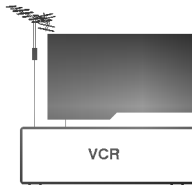

You can connect additional equipment, such as VCRs, camcorders etc. to your set. Here shown may be somewhat different from your set.

Aerial socket

1. Connect the RF out socket of the VCR to the aerial socket on the back of the set.
2. Connect the aerial cable to the RF aerial in socket of the VCR.
3. Store the VCR channel on a desired programme number using the 'Manual programme tuning' section.
4. Select the programme number where the VCR channel is stored.
5. Press the **PLAY** button on the VCR.

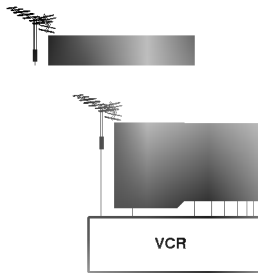

Audio/Video in/out sockets (option)

1. Connect the audio/video out sockets of the VCR to audio/video in sockets of the set and in sockets of the VCR to out sockets of the set.
2. If the VCR is connected to the AV sockets on the front, press the **TV/AV** button to select **AV 2**. You should select **AV 1** if **AV1** sockets on the back are connected to the VCR.
3. Press the **PLAY** button on the VCR.
The VCR playback picture appears on the screen.

You can also record programmes received by the TV on video tape via audio/video out sockets.

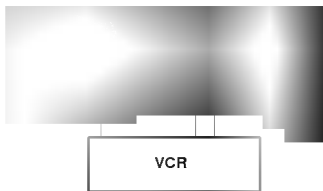

Euro scart socket (option)

1. Connect the Euro scart socket of the VCR to the Euro scart socket of the set.
2. Press the **PLAY** button on the VCR.
If your VCR outputs a switching voltage the set will switch to AV1 mode automatically.
Otherwise press the **TV/AV** button on the remote control handset to select **AV 1**. The VCR playback picture appears on the screen.

You can also record programmes received by the TV on video tape.

Note : Signal type RGB, i.e. the signals red, green and blue can only be selected for the Euro scart socket. These signals are transmitted, for example, by a computer, pay TV decoder, game machine or photo CD unit, etc.

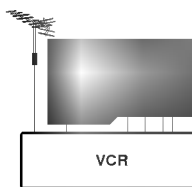

Headphone socket (option)

In some models which have a headphone socket can perform this function.

Insert the headphone plug to the headphone socket on the front panel.

You can listen to the sound through the headphone. To adjust the headphone volume, press the $\text{c}/\text{c}^{\circ}$ button.

If you press the **MUTE** button, the sound from the headphone is switched off.

Troubleshooting check list

Symptoms

No picture, no sound

Sound OK, poor picture

Picture OK, poor sound

Picture blurred

Lines or streaks in picture

Poor reception on some channels

No colour

Poor colour

Remote control does not work



Check these items and try to adjust these

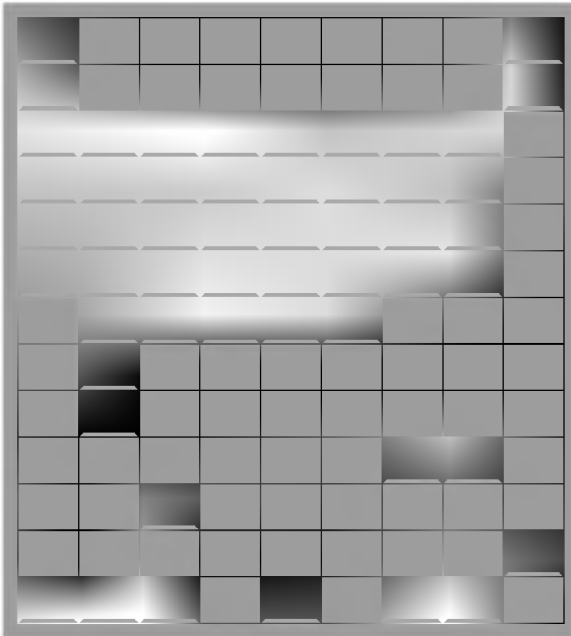

The mains plug-(plugged in and switched on)

Is the TV switched on

Try another channel (weak signal)

Check aerial (plugged into TV?)

Check aerial (broken lead?)

Check aerial

Check for local interference

Adjust contrast

Adjust brightness

Adjust colour

Adjust volume

Check the batteries in remote control

Check Audio/Video sockets (VCR only)
