

GoldStar

MICROWAVE OVEN

OWNER'S MANUAL & COOKING GUIDE

PLEASE READ THIS OWNER'S MANUAL
THOROUGHLY BEFORE OPERATING.

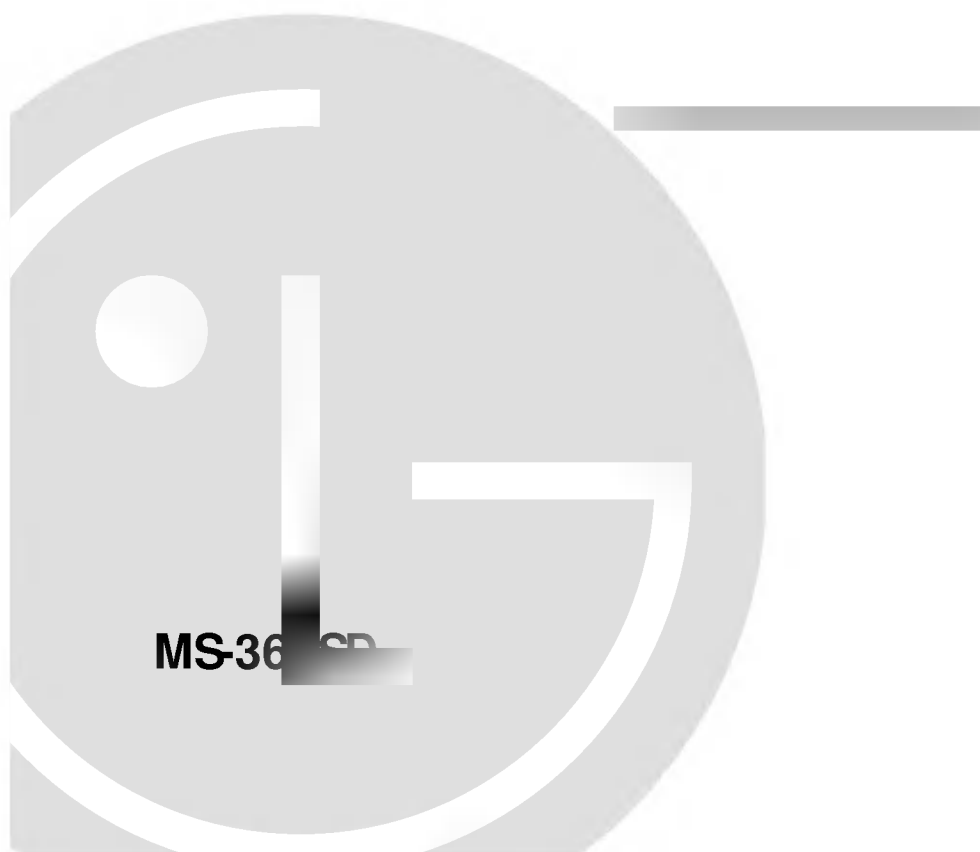

Precautions to avoid possible exposure to excessive microwave energy.

You cannot operate your oven with the door open due to the safety interlocks built into the door mechanism. These safety interlocks automatically switch off any cooking activity when the door is opened; which in the case of a microwave oven could result in harmful exposure to microwave energy. **It is important not to tamper with the safety interlocks.**

Do not place any object between the oven front face and the door or allow food or cleaner residue to accumulate on sealing surfaces.

Do not operate your oven if it is damaged. It is particularly important that the oven door closes properly and that there is no damage to the: (1) door(bent), (2) hinges and latches (broken or loosened), (3) door seals and sealing surfaces.

Your oven should not be adjusted or repaired by anyone except qualified service personnel.

Warning

Please ensure cooking times are correctly set as over cooking may result in the FOOD catching fire and subsequent damage to your oven.

When heating liquids, e.g. soups, sauces and beverages in your microwave oven, overheating the liquid beyond boiling point can occur without evidence of bubbling. This could result in a sudden boil over of the hot liquid. To prevent this possibility the following steps should be taken:

- 1 Avoid using straight sided containers with narrow necks.
- 2 Do not overheat.
- 3 Stir the liquid before placing the container in the oven and again halfway through the heating time.
- 4 After heating, allow to stand in the oven for a short time, stir or shake them again carefully and check the temperature of them before consumption to avoid burns (especially, contents of feeding bottles and baby food jars).

Warning

Always allow food to stand after being cooked by microwaves and check the temperature of them before consumption. Especially contents of feeding bottles and baby food jars.

How the Microwave Oven Works

Microwaves are a form of energy similar to radio and television waves and ordinary daylight. Normally, microwaves spread outwards as they travel through the atmosphere and disappear without effect. Microwave ovens, however, have a magnetron which is designed to make use of the energy in microwaves. Electricity, supplied to the magnetron tube, is used to create microwave energy.

These microwaves enter the cooking area through openings inside the oven. A turntable or tray is located at the bottom of the oven. Microwaves cannot pass through metal walls of the oven, but they can penetrate such materials as glass, porcelain and paper, the materials out of which microwave-safe cooking dishes are constructed.

Microwaves do not heat cookware, though cooking vessels will eventually get hot from the heat generated by the food.

A very safe appliance

Your microwave oven is one of the safest of all home appliances. When the door is opened, the oven automatically stops producing microwaves. Microwave energy is converted completely to heat when it enters food, leaving no “left over” energy to harm you when you eat your food.

PRECAUTIONS	2
CONTENTS	3
UNPACKING & INSTALLING	4
FEATURE DIAGRAM / CONTROL PANEL	6
OPERATING INSTRUCTIONS	7
SETTING THE CLOCK/CHILD LOCK/QUICK START	7
TIME & POWER COOKING/MICROWAVE POWER LEVEL TABLE	8
TEMPERATURE SETTING & PRESERVING/SENSOR REHEAT	9
SENSOR REHEAT GUIDE/SENSOR DEFROST	10
SENSOR DEFROST GUIDE	11
AUTO COOK/AUTO COOK GUIDE	12
HEATING OR REHEATING GUIDE	13
FRESH VEGETABLE CHART	14
MICROWAVE-SAFE UTENSILS	15
FOOD CHARACTERISTICS & MICROWAVE COOKING	16~17
SAFETY PRECAUTIONS	18
QUESTION & ANSWERS	19
PLUG WIRING INFORMATION/TECHNICAL SPECIFICATIONS	20

By following the basic steps on these two pages you will be able to quickly check that your oven is operating correctly. Please pay particular attention to the guidance on where to install your oven. When unpacking your oven make sure you remove all accessories and packing. Check to make sure that your oven has not been damaged during delivery.

- 1** Unpack your oven and place it on a flat level surface.

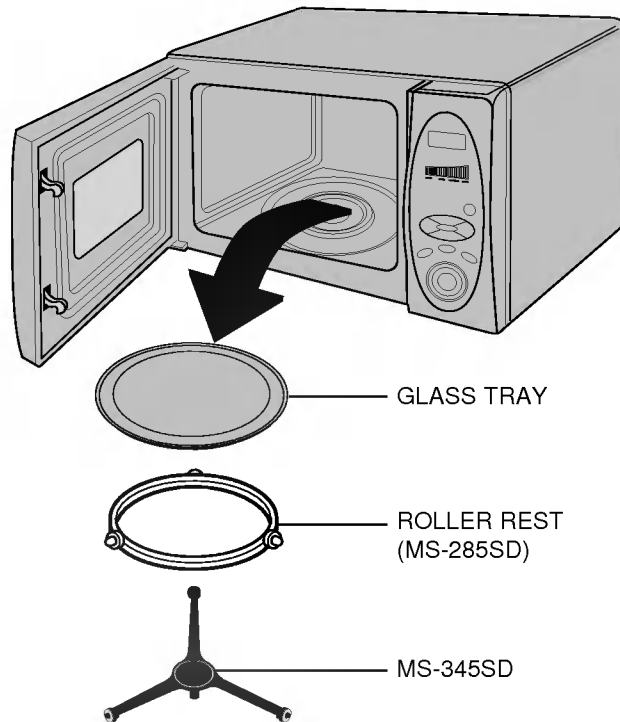

- 2** Place your oven on a flat, level surface but make sure there is at least **10 cm** of space on the top, rear and sides so there is air flow for ventilation. Exhaust outlets are located in the back and side of your oven. Blocking the outlets can damage your oven. **THIS OVEN IS DESIGNED FOR BUILDING IN.** (Not over a heat source)

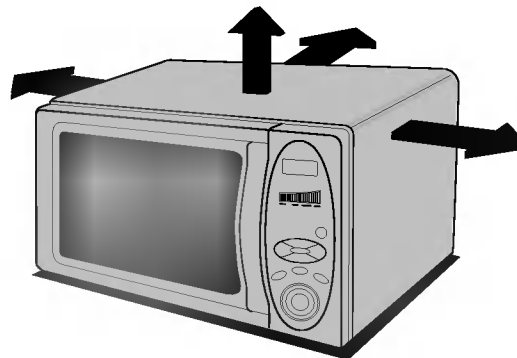

THIS OVEN SHOULD NOT BE USED FOR COMMERCIAL CATERING PURPOSES

3

Plug your oven into a standard household socket. Make sure your oven is the only appliance connected to the socket. **If your oven does not operate properly, unplug it from the electrical socket and then plug it back in.**

4

Open your oven door by pull the **DOOR** handle button. Place the **ROLLER REST** inside the oven and place the **GLASS TRAY** on top.

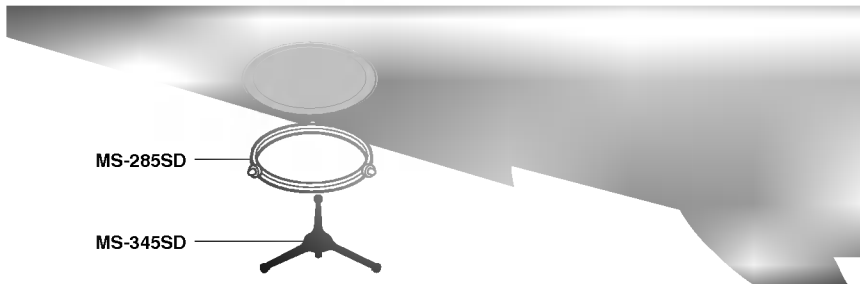

5

Fill a **microwave safe container** with 300 ml (1/2 pint) of water. Place on the **GLASS TRAY** and close the oven door. If you have any doubts about what type of container to use please refer to page 15.

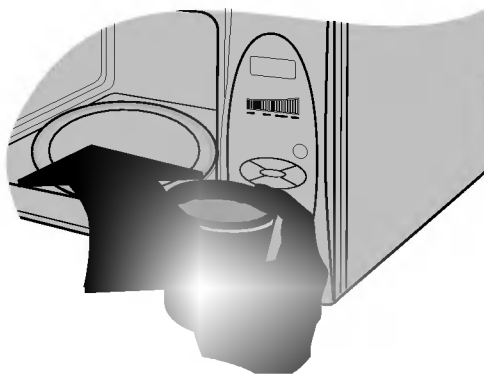

6

Press the **Start** button six times to set 3 minutes of cooking time. You will hear a BEEP each time you press the button. Your oven will start before you have finished the sixth press; don't worry this is normal.



7

The **DISPLAY** will count down from 3 minutes. When it reaches 0 it will sound three BEEPS. Open the oven door and test the temperature of the water. If your oven is operating the water should be warm. **Be careful when removing the container it may be hot.**



YOUR OVEN IS NOW INSTALLED

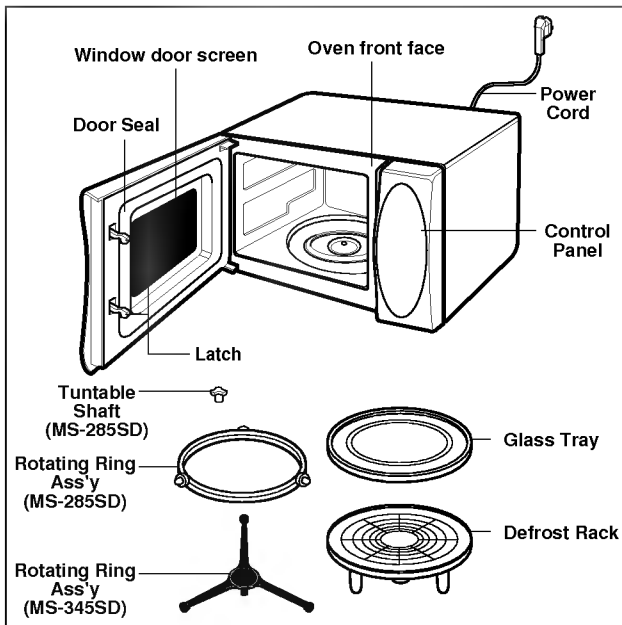

Your oven will be packed with the following materials :

- Glass Tray.....1
- Rotating Ring Ass'y.....1
- Owner's manual & Cooking Guide.....1
- Defrost Rack.....1
- Turntable Shaft.....1
- (ONLY MS-285SD)

This microwave oven is designed for household use only. It is not recommended for commercial purposes.

Do not operate the oven when the oven is empty without food.

DISPLAY INDICATOR- Shows:
Time of Day,
Cooking power Level,
Cooking Category.

TEMPERATURE INDICATOR
Shows the current and set temperature.

- Defrost
- Tepid
- Warm
- Hot

AUTO COOK MENUS

1. Jacket Potato
2. Rice / Pasta
3. Fresh Vegetable
4. Frozen Vegetable
5. Fresh Fish
6. Casserole

SENSOR CHILLED REHEAT
Used to reheat chilled food.

SENSOR DEFROST
Used to defrost foods.

CLOCK
Used to set the time of day.

START /QUICK START
Used to start cooking and set the cooking time quickly and directly.

TEMPERATURE BUTTON
Used to set the temperature of foods.

SENSOR FROZEN REHEAT
Used to reheat frozen food.

SENSOR ROOM REHEAT
Used to reheat room temperature food.

MICRO POWER
Used to set cooking power levels.

STOP / CLEAR
Stops the oven and clear all entries except the time of day.

DIAL KNOB
Used to set Cooking Time, Auto Cook menu and Weight.

NOTE: A beep sounds when a pad on the control panel is touched, to indicate a setting has been entered.

Setting the Clock

For example, current time of day is 2:59 AM.

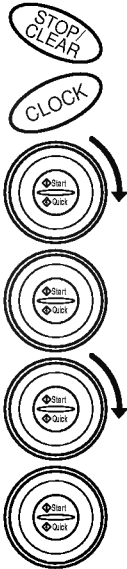

1. Touch **STOP/CLEAR**.
2. Touch **CLOCK**.
3. Turn **DIAL** knob until display shows 2 hours.
4. Touch **Start** for hour confirmation.
5. Turn **DIAL** knob until display shows 59 minutes.
6. Touch **Start** again.
The clock starts counting.

When your oven is plugged in for the first time or when power resumes after a power interruption, the numbers in the display reset to 0.

NOTE:

If the **CLOCK** (or **DISPLAY**) shows any abnormality, unplug the oven from the AC outlet, plug it back in and then reset the **CLOCK**.

Child Lock

To set



1. Touch **STOP/CLEAR**.
2. Touch and hold **STOP/CLEAR** for about 4 sec. until "L" appears in the display.

To cancel the child lock



1. Touch and hold **STOP/CLEAR** for about 4 sec until "L" disappears in the display.

This is a unique safety feature that prevents accidental running of the oven. Once the child lock is set, you can't input any key.

Quick Start

For example, to cook for 2 min. on Hi power.



1. Touch **STOP/CLEAR**.
2. Touch **Quick Start** (**Quick**) 4 times to set 2 min. on high power.

NOTE: During **Quick Start** cooking, you can extend cooking time up to 99 min.

The **Quick Start** feature allows you to cook for up to 99 minutes on Hi Power by touching **START** (**Quick**) key repeatedly. 30 sec. will be added at every touch of the key.

Time & Power Cooking

For example, To cook food on 80% Power for 5 minutes 30 seconds.

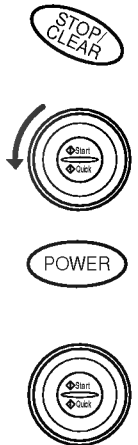
- 
1. Touch **STOP/CLEAR**.
 2. Turn **DIAL** knob to the left until display shows 5:30.
 3. Touch **POWER** twice.
 4. Touch **Start**.
If you want to cook on Hi Power, skip the step 3.

The oven has five power settings, incorporating the most commonly used power levels.
At any time you touch the Power Level, you can select different power.

NOTE :
Power key does not work independently.

Microwave Power Level Table

Power Level	Key Sequence	Output (of watts)	Use
HIGH	1 time	100%	<ul style="list-style-type: none"> * Boil water. * Brown minced beef. * Cook fresh fruits & vegetables. * Cook fish meat & poultry. * Preheat browning dish. * Heat precooked food. * Sauté onions, celery & green pepper.
M-HIGH	2 times	80%	<ul style="list-style-type: none"> * All reheating. * Roast meat & poultry. * Cook mushrooms & shellfish. * Cook foods which contain cheese & eggs.
MEDIUM	3 times	60%	<ul style="list-style-type: none"> * Bake cakes, scones. * Prepare eggs. * Cook meat, poultry. * Cook custard. * Prepare rice, soup.
DEFROST MEDIUM LOW	4 times	40%	<ul style="list-style-type: none"> * All thawing. * Melt butter & chocolate. * Cook less tender cuts of meats.
LOW / WARM	5 times	20%	<ul style="list-style-type: none"> * Soften butter & cheese. * Soften ice cream. * Raise yeast dough.

Temperature Setting & Preserving

For example, to reheat some foods up to 60°C with 80% power level and then preserve the temperature(60°C) for 20 Min.

1. Place the food in the oven and close the door.
2. Touch **STOP/CLEAR**.
3. Touch **TEMPERATURE** button 3 times.
4. Touch **POWER** twice.
5. Turn **DIAL** knob until display shows 20:00.
6. Touch **Start**.

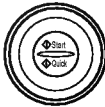
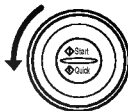

This feature allows you to reheat food to the temperature you set and preserve the temperature for the time you want.

Defrost
Tepid
Warm
Hot

NOTE :

1. Temperature Range you can set is from 40°C to 100°C (). At any touch of the key, you can set different temperature.
2. If you want to set power level at High (100%), skip the step 4. Refer to the Time & Power Cooking page for details.
3. If you don't want to preserve temperature after reheating, skip the step 5.
4. The actual food temperature after reheating might be slightly different from the temperature you have set.

To prevent this:

- 1) Do not cover with lid.
- 2) Put the foods in utensil on the center of glass tray
- 3) Do not use thick and high utensil
5. Do not open the door during temperature setting & preserving process.

Sensor Reheat (Chilled / Frozen / Room Temperature)

For example, to reheat chilled food.

1. Place the chilled food in the oven and close the door.
2. Touch **STOP/CLEAR**.
3. Touch **CHILLED REHEAT** key. The oven starts working without the need to touch **Start**.

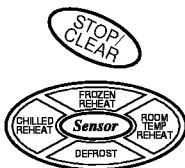

Sensor Reheat made easy. You can reheat food by touching only one key.

NOTE:

Do not open the door during sensor reheat process.

Sensor Reheat Guide

CATEGORY	STARTING TEMPERATURE	WEIGHT RANGE	MENU INCLUDES	UTENSILS	
Chilled Reheat	Refrigerator	0.2~1.0kg	Stirrable: Sphagetti: Non-stirrable: Lasagne plate of meals	Casserole dish	<ul style="list-style-type: none"> • Wrap with cling film. • Do not cover with lid or aluminium foil. • If material on the cover of package is not film, should be use cling film. • Place the meal on the center of the turntable. • After Cooking, let stand 2 minutes.
Frozen Reheat	Frozen	0.3~0.7kg	Stirrable: Sphagetti Non-stirrable: Lasagne Frozen entree	tray provided	<ul style="list-style-type: none"> • Wrap with cling film. • Do not cover with lid or aluminium foil. • If material on the cover of package is not film, should be use cling film. • If the packaging is damaged, place the food in a similar shape and size dish. • Place the meal on the center of the turntable. • After cooking, let stand 2 minutes.
Room Temperature Reheat	Room	0.2~0.6kg	Soup Stew Baked beans Curry	Casserole dish	<ul style="list-style-type: none"> • Empty the contents of the can into a suitable sized dish. • Wrap with cling film. • Do not cover with lid or aluminium foil. • If material on the cover of package is not film, should be use cling film. • Place the meal on the center of the turntable. • After cooking, let stand 2 minutes.

NOTE :

- Chilled / Frozen / Room Reheat program is not suitable for heating convenience ready foods not recommended for microwaving.
- Do not open the door during the reheating process. This causes inaccurate cooking results.
- Once the timer begins to count down, the oven door may be opened to stir, shield or add foods.
- Do not use the "Frozen Reheat" Key on food that is not frozen. This may reduce the quality of the food.
- Remove the cover of cooking vessel.

Sensor Defrost : The weight range of defrost is from 0.2kg to 2.0kg

MODE	SELECTING METHOD	WEIGHT RANGE	UTENSIL	INSTRUCTIONS
dEF1	touch "DEFROST" once	0.2~1.0kg	DEFROST RACK	When beep sounds during the defrosting process, turn food over and restart.
dEF2	touch "DEFROST" twice	1.0kg~2.0kg	DEFROST RACK	

If you want to sensor defrost frozen food of 1.5kg.

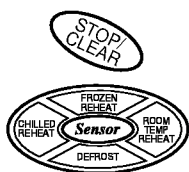

1. Place the frozen food on recommended utensil in the oven and close the door.
2. Touch **STOP/CLEAR**.
3. Touch **DEFROST** twice to select dEF2 mode. Since the weight is in the range of 1.0~2.0kg.

NOTE:

1. For best results, when beep sound, turn food over.
2. Do not cover with plastic wrap. Otherwise it will hold steam and juice close to the food which can cause the outer surface of the food to cook.
3. This oven starts 2~3 seconds after 3rd-step, or you can touch start button.

Sensor Defrost Guide

FOODS	WEIGHT RANGE	INSTRUCTIONS
Meat joint Lamb	0.2~2.0kg	<ul style="list-style-type: none"> Place meat in a defrost rack on the turntable. When the beep sounds, turn over. To prevent overdefrosting, thin area of edges can be shielded with strips of aluminum foil. Stand, wrapped in foil, for 5 minutes until defrost.
Minced Meat Lamb	0.2~2.0kg	<ul style="list-style-type: none"> Place minced meat in a defrost rack on the turntable. When the beep sounds, turn over. Stand, wrapped in foil, for 5 minutes until defrost.
Poultry	1.2~1.8kg	<ul style="list-style-type: none"> Place poultry breast side down in a defrost rack on the turntable. When the beep sounds, turn over. When defrosting, wrap the edges of legs with aluminum foil if they are not wrapped, the process could be finished too quickly before it is done. Stand, wrapped in foil, for 10 minutes until defrost.
Chicken Portions	0.2~1.0kg	<ul style="list-style-type: none"> Place portion breast side down in a defrost rack on the turntable. When the beep sounds, turn over. To prevent overdefrosting, thin area of edges can be shielded with strips of aluminum foil. Stand, wrapped in foil, for 5 minutes until defrost.
Fish	0.2~1.0kg	<ul style="list-style-type: none"> Place fish on (in) a defrost rack on the turntable. When the beep sounds, turn over. To prevent overdefrosting, thin area of edges can be shielded with strips of aluminum foil. Stand, wrapped in foil, for 5 minutes until defrost.
Bread	0.2~0.5kg	<ul style="list-style-type: none"> Bread rolls should be cut in half before defrosting. Place bread on (in) a defrost rack on the turntable. When the beep sounds, turn over. Stand for 5 minutes until defrost.

NOTE :

- For best results, remove foods from its original paper or plastic package(wrapper). Otherwise it will hold steam and juice close to the food which can cause the outer surface of the food to cook.
- For best results, when the beep sounds, turn food over.
- Do not open the door during the defrosting process. This causes inaccurate cooking results.
- Do not defrost if the glass tray is already hot, otherwise the food isn't defrosted properly, beginning with the glass tray at room temperature yields the best results.
- Large roasts and whole poultry may still be icy in center after defrosting, allow to stand in the refrigerator covered with cling film or rinse under cold water for 2~3 minutes.
- Fish and seafood should be slightly icy after defrosting, allow to stand and rinse under cold water for 2~3 minutes.
- Defrosted item in 2 layers should be rinsed separately or have a longer stand time.

Auto Cook

For example, to cook 400g of Frozen Vegetable.

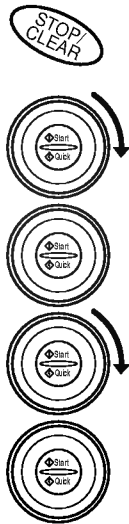

1. Place the Frozen Vegetable in the oven and close the door.
2. Touch **STOP/CLEAR**.
3. Turn **DIAL** knob to the right until display shows 4.
4. Touch **Start** for menu confirmation.
5. Turn **DIAL** knob until display shows 0.4.
6. Touch **Start**.
The oven starts working.

Auto cook allows you to prepare most of your favorite food by selecting the food type, and the weight of the food by the **DIAL** knob.

Auto Cook Guide

COOK NUMBER	MENU	WEIGHT RANGE	UTENSILS	COVER	INSTRUCTIONS
1	Jacket Potato	0.2~1.0kg 230g each		None	<ul style="list-style-type: none"> • Wash and dry the potatoes. • Pierce each potato four times on each side. • Place on the outside of the turntable evenly spaced. • After cooking, let stand 5 minutes.
2	Rice / Pasta	0.1~0.3kg	Casserole dish	Lid	<ul style="list-style-type: none"> • Add 2.5 times the volume of boiling water to the rice or pasta. • Cover with lid. • Place the dish on the center of the turntable. • When the beep sounds, stir several times. • After cooking, let stand 3 to 5 minutes or until all liquid has been absorbed.
3	Fresh vegetable	0.2~0.8kg	Casserole dish	Cling film	<ul style="list-style-type: none"> • Add 30ml water per 200g vegetable. • Cover with cling film. • After cooking, let stand 2 minutes.
4	Frozen vegetable	0.2~0.8kg	Casserole dish	Cling film	<ul style="list-style-type: none"> • Add 30ml water per 200g vegetable. • Cover with cling film. • After cooking, let stand 2 minutes.
5	Fresh fish	0.2~1.0kg	Flan dish	Cling film	<ul style="list-style-type: none"> • Choose fish of a similar shape and size. • Place in a single layer in a flan dish. • Cover with cling film. • After cooking, let stand 2 minutes.
6	Casserole	0.5~2.0kg	Casserole dish	Lid	<ul style="list-style-type: none"> • Place the casserole in the dish and cover with lid. • When the beep sounds, stir several times. • After cooking, let stand 5 minutes.

To heat or reheat successfully in the microwave, it is important to follow several guidelines. Measure the amount of food in order to determine the time needed to reheat. Arrange the food in a circular pattern for best results. Room temperature food will heat faster than refrigerated food. Canned foods should be taken out of the can and placed in a microwavable container. The food will be heated more evenly if covered with a microwavable lid or plastic wrap, vented. Remove cover carefully to prevent steam burns. Use the following chart as a guide for reheating cooked food.

Items	Cook time (at HIGH)	Special Instructions
Sliced meat 3 slices (0.5 cm/1/4 inch thick)	1 1/2~2 minutes	Place sliced meat on microwavable plate. Cover with plastic wrap and vent. *Note: Gravy or sauce helps to keep meat juicy.
Chicken pies 1 breast 1 leg and thigh	2~3 minutes	Place chicken pieces on microwavable plate. 1 1/2~2 minutes Cover with plastic wrap and vent.
Fish fillet (150 g~220 g/6~8 oz)	1 1/2~2 minutes	Place fish on microwavable plate. Cover with plastic wrap and vent.
Lasagna 1 serving(280 g/10 1/2 oz)	5~7 minutes	Place lasagna on microwavable plate. Cover with plastic wrap and vent.
Casserole 1 cup 4 cups	1 1/2~3 minutes 5~7 minutes	COOK covered in microwavable casserole. Stir once halfway through cooking.
Casserole cream or cheese 1 cup 4 cups	1 1/2~2 1/2 minutes 4~6 minutes	COOK covered in microwavable casserole. Stir once halfway through cooking.
Sloppy Joe or Barbecued beef 1 sandwich (1/2 cup meat filling) without bun	1 ~2 1/2 minutes	Reheat filling and bun separately. Cook filling covered in microwavable casserole. Stir once. Heat bun as directed in chart below.
Mashed potatoes 1 cup 4 cups	2~3 minutes 6~8 minutes	COOK covered in microwavable casserole. Stir once halfway through cooking.
Baked beans 1 cup	2~3 minutes	COOK covered in microwavable casserole. Stir once halfway through cooking.
Ravioli or pasta in sauce 1 cup 4 cups	3~4 minutes 8~11 minutes	COOK covered in microwavable casserole. Stir once halfway through cooking.
Rice 1 cup 4 cups	1 1/2~2 minutes 4~6 minutes	COOK covered in microwavable casserole. Stir once halfway through cooking.
Sandwich roll or bun 1 roll	20~35 seconds	Wrap in paper towel and place on glass microwavable rack.
Vegetables 1 cup 4 cups	1 1/2~3 minutes 4~6 minutes	COOK covered in microwavable casserole. Stir once halfway through cooking.
Soup 1 serving(220 g/8 oz)	2~3 minutes	COOK covered in microwavable casserole. Stir once halfway through cooking.

Vegetable	Amount	Cook time at HIGH	Instructions	Standing Time
Artichokes (220 g/8 oz each)	2 medium 4 medium	5~6 10~12	Trim. Add 2 tsp water and 2 tsp juice. Cover.	2-3 minutes
Asparagus, Fresh, spears	450 g (1 lbs)	6~7	Add 1/2 cup water. Cover.	2-3 minutes
Beans, green & wax	450 g (1 lbs)	7~9	Add 1/2 cup water in 1- 1/2 qt. casserole. Stir halfway through cooking.	2-3 minutes
Beets, Fresh	450 g (1 lbs)	12~15	Add 1/2 cup water in 1- 1/2 qt. covered casserole. Rearrange halfway through cooking.	2-3 minutes
Broccoli, Fresh, spears	450 g (1 lbs)	5~7	Place broccoli in baking dish. Add 1/2 cup water.	2-3 minutes
Cabbage, Fresh, chopped	450 g (1 lbs)	4~6	Add 1/2 cup water in 1- 1/2 qt. covered casserole. Stir halfway through cooking.	2-3 minutes
Carrots, Fresh, sliced	2 cups	3~5	Add 1/4 cup water in 1 qt. covered casserole. Stir halfway through cooking.	2-3 minutes
Cauliflower, Fresh, whole	450 g (1 lbs)	5~7	Trim. Add 1/4 cup water in 1 qt. covered casserole. Stir halfway through cooking.	2-3 minutes
Fresh, flowerettes Celery, Fresh, sliced	2 cups 4 cups	3~5 5~7	Slice. Add 1/2cup water in 1-1/2qt. covered casserole. Stir halfway through cooking	2-3 minutes
Corn, Fresh	2 ears	6~8	Husk. Add 2 tbsp water in 1-1/2 qt. baking dish. Cover.	2-3 minutes
Mushrooms, Fresh, sliced	220 g (1/2 lbs)	1~2	Place mushrooms in 1-1/2 qt. covered casserole. Stir halfway through cooking.	2-3 minutes
Parsnips, Fresh, sliced	450 g (1 lbs)	5~7	Add 1/2 cup water in 1-1/2 qt. covered casserole. Stir halfway through cooking.	2-3 minutes
Peas, Green, Fresh	4 cups	6~7	Add 1/2 cup water in 1-1/2 qt. covered casserole. Stir halfway through cooking.	2-3minutes
Sweet Potatoes Whole Baking (160~220 g each)	2 medium 4 medium	6~9 10~13	Pierce potatoes several times with fork. Place on 2 paper towels. Turn over halfway through cooking.	2-3 minutes 2-3 minutes
White potatoes, Whole Baking (160~220 g each) (6~8 oz)	2 potatoes 4 potatoes	7~9 11~14	Pierce potatoes several times with fork. Place on 2 paper towels. Turn over halfway through cooking	2-3 minutes 2-3 minutes
Spinach, Fresh, leaf	450 g (1 lbs)	4~6	Add 1/2 cup water in 2 qt. covered casserole.	2-3 minutes
Squash, Acorn or butternut, Fresh	1 medium	5~6	Cut squash in half. Remove seeds. Place in 20 X 20 cm baking dish. Cover.	2-3 minutes
Zucchini, Fresh, sliced	450 g (1 lbs)	3~5	Add 1/2 cup water in 1-1/2 qt. covered casserole. Stir halfway through cooking.	2-3 minutes
Zucchini, Fresh, whole	450 g (1 lbs)	4~6	Pierce. Place on 2 paper towels. Turn zucchini over and rearrange halfway through cooking.	2-3 minutes

Never use metal or metal trimmed utensils in your microwave oven

Microwaves cannot penetrate metal. They will bounce off any metal object in the oven and cause arcing, an alarming phenomenon that resembles lightning.

Most heat resistant non metallic cooking utensils are safe for use in your microwave oven.

However, some may contain materials that render them unsuitable as microwave cookware. If you have any doubts about a particular utensil, there's a simple way to find out if it can be used in your microwave oven.

Place the utensil in question next to a glass bowl filled with water in the microwave oven.

Microwave at power HIGH for 1 minute. If the water heats up but the utensil remains cool to the touch, the utensil is microwave-safe. However, if the water does not change temperature but the utensil becomes warm, microwaves are being absorbed by the utensil and it is not safe for use in the microwave oven. You probably have many items on hand in your kitchen right now that can be used as cooking equipment in your microwave oven. Just read through the following checklist.

Dinner plates

Many kinds of dinner-ware are microwave-safe.

If in doubt consult the manufacturer's literature or perform the microwave test.

Glassware

Glassware that is heat-resistant is microwave-safe. This would include all brands of oven tempered glass cookware. However, do not use delicate glassware, such as tumblers or wine glasses, as these might shatter as the food warms.

Plastic storage containers

These can be used to hold foods that are to be quickly reheated. However, they should not be used to hold foods that will need considerable time in the oven as hot foods will eventually warp or melt plastic containers.

Paper

Paper plates and containers are convenient and safe to use in your microwave oven, provided that the cooking time is short and foods to be cooked are low in fat and moisture. Paper towels are also very useful for wrapping foods and for lining baking trays in which greasy foods such as bacon are cooked. In general, avoid colored paper products as the colour may run. Some recycled paper products may contain impurities which could cause arcing or fires when used in the microwave oven.

Plastic cooking bags

Stirring is one of the most important of all microwaving techniques. In conventional cooking, foods are stirred for the purpose of blending. Microwaved foods, however, are stirred in order to spread and redistribute heat. Always stir from the outside towards the centre as the outside of the food heats first.

Plastic microwave cookware

A variety of shapes and sizes of microwave cookware are available. For the most part, you can probably use items you already have on hand rather than investing in new kitchen equipment.

Pottery, stoneware and ceramic

Containers made of these materials are usually fine for use in your microwave oven, but they should be tested to be sure.

CAUTION

Some items with high lead or iron content are not suitable for cooking utensils.

FOOD CHARACTERISTICS & MICROWAVE COOKING

Keeping an eye on things

The recipes in this book have been formulated with great care, but your success in preparing them depends on how much attention you pay to the food as it cooks. Always watch your food while it cooks. Your microwave oven is equipped with a light that turns on automatically when the oven is in operation so that you can see inside and check the progress of your food. Directions given in recipes to elevate, stir, and the like should be thought of as the minimum steps recommended. If the food seems to be cooking unevenly, simply make the necessary adjustments you think appropriate to correct the problem.

Factors affecting microwave cooking times

Many factors affect cooking times. The temperature of ingredients used in a recipe makes a big difference in cooking times. For example, a cake made with ice-cold butter, milk, and eggs will take considerably longer to bake than one made with ingredients that are at room temperature. All of the recipes in this book give a range of cooking times. In general, you will find that the food remains under-cooked at the lower end of the time range, and you may sometimes want to cook your food beyond the maximum time given, according to personal preference. The governing philosophy of this book is that it is best for a recipe to be conservative in giving cooking times. While overcooked food is ruined for good. Some of the recipes, particularly those for bread, cake, and custards, recommend that food be removed from the oven when they are slightly undercooked. This is not a mistake. When allowed to stand, usually covered, these foods will continue to cook outside of the oven as the heat trapped within the outer portions of the food gradually travels inward. If the food is left in the oven until it is cooked all the way through, the outer portions will become overcooked or even burnt. You will become increasingly skilful in estimating both cooking and standing times for various foods.

Density of food

Light, porous food such as cakes and bread cook more quickly than heavy, dense foods such as roasts and casseroles. You must take care when microwaving porous food that the outer edges do not become dry and brittle.

Height of food

The upper portion of tall food, particularly roasts, will cook more quickly than the lower portion. Therefore, it is wise to turn tall food during cooking, sometimes several times.

Moisture content of food

Since the heat generated from microwaves tends to evaporate moisture, relatively dry food such as roasts and some vegetables should either be sprinkled with water prior to cooking or covered to retain moisture.

Bone and fat content of food

Bones conduct heat and fat cooks more quickly than meat. Care must be taken when cooking bony or fatty cuts of meat that they do not cook unevenly and do not become overcooked.

Quantity of food

The number of microwaves in your oven remains constant regardless of how much food is being cooked. Therefore, the more food you place in the oven, the longer the cooking time. Remember to decrease cooking times by at least one third when halving a recipe.

Shape of food

Microwaves penetrate only about 2.5 cm into food, the interior portion of thick foods are cooked as the heat generated on the outside travels inward. Only the outer edge of food is cooked by microwave energy; the rest is cooked by conduction. The worst possible shape for a food that is to be microwaved is a thick square. The corners will burn long before the centre is even warm. Round thin foods and ring shaped foods cook successfully in the microwave.

Covering

A cover traps heat and steam which causes food to cook more quickly. Use a lid or microwave cling film with a corner folded back to prevent splitting.

Browning

Meats and poultry that are cooked fifteen minutes or longer will brown lightly in their own fat. Food that is cooked for a shorter period of time may be brushed with a browning sauce such as Worcestershire sauce, soy sauce or barbecue sauce to achieve an appetizing colour. Since relatively small amounts of browning sauce is added to food, the original flavour of the recipe is not altered.

Covering with greaseproof paper

Greaseproofing effectively prevents spattering and helps food retain some heat. But because it makes a looser cover than a lid or clingfilm, it allows the food to dry out slightly.

Arranging and spacing

Individual foods such as baked potatoes, small cakes and hors d'oeuvres will heat more evenly if placed in the oven an equal distance apart, preferably in a circular pattern. Never stack foods on top of one another.

FOOD CHARACTERISTICS & MICROWAVE COOKING

Stirring

Stirring is one of the most important of all microwaving techniques. In conventional cooking, food is stirred for the purpose of blending. Microwaved food, however, is stirred in order to spread and redistribute heat. Always stir from the outside towards the centre as the outside of the food heats first.

Turning over

Large, tall foods such as roasts and whole chickens should be turned so that the top and bottom will cook evenly. It is also a good idea to turn cut up chicken and chops.

Placing thicker portions facing outwards

Since microwaves are attracted to the outside portion of food, it makes sense to place thicker portions of meat, poultry and fish to the outer edge of the baking dish. This way, thicker portions will receive the most microwave energy and the food will cook evenly.

Shielding

Strips of aluminium foil (which block microwaves) can be placed over the corners or edges of square and rectangular food to prevent those portions from overcooking. Never use too much foil and make sure the foil is secured to the dish or it may cause 'arcing' in the oven.

Elevating

Thick or dense foods can be elevated so that microwaves can be absorbed by the underside and centre of the foods.

Piercing

Foods enclosed in a shell, skin or membrane are likely to burst in the oven unless they are pierced prior to cooking. Such foods include yolks and whites of eggs, clams and oysters and whole vegetables and fruits.

Testing if cooked

Food cooks so quickly in a microwave oven, it is necessary to test it frequently. Some foods are left in the microwave until completely cooked, but most foods, including meats and poultry, are removed from the oven while still slightly undercooked and allowed to finish cooking during standing time. The internal temperature of foods will rise between 5 °C (3 °F) and 15 °C (8 °F) during standing time.

Standing time

Foods are often allowed to stand for 3 to 10 minutes after being removed from the microwave oven. Usually the foods are covered during standing time to retain heat unless they are supposed to be dry in texture (some cakes and biscuits, for example). Standing allows foods to finish cooking and also helps flavour blend and develop.

To Clean Your Oven

- 1 Keep the inside of the oven clean
Food spatters or spilled liquids stick to oven walls and between seal and door surface. It is best to wipe up spillovers with a damp cloth right away. Crumbs and spillovers will absorb microwave energy and lengthen cooking times. Use a damp cloth to wipe out crumbs that fall between the door and the frame. It is important to keep this area clean to assure a tight seal. Remove greasy spatters with a soapy cloth then rinse and dry. Do not use harsh detergent or abrasive cleaners. The glass tray can be washed by hand or in the dishwasher.
- 2 Keep the outside of the oven clean
Clean the outside of your oven with soap and water then with clean water and dry with a soft cloth or paper towel. To prevent damage to the operating parts inside the oven, the water should not be allowed to seep into the ventilation openings. To clean control panel, open the door to prevent oven from accidentally starting, and wipe a damp cloth followed immediately by a dry cloth. Press STOP after cleaning.
- 3 If steam accumulates inside or around the outside of the oven door, wipe the panels with a soft cloth. This may occur when the microwave oven is operated under high humidity conditions and in no way indicates a malfunction of the unit.
- 4 The door and door seals should be kept clean. Use only warm, soapy water, rinse then dry thoroughly.
DO NOT USE ABRASIVE MATERIALS, SUCH AS CLEANING POWDERS OR STEEL AND PLASTIC PADS.
Metal parts will be easier to maintain if wiped frequently with a damp cloth.

WARNING

Please ensure cooking times are correctly set as over cooking may result in FIRE and subsequent DAMAGE to the OVEN.

1. Do not attempt to tamper with, or make any adjustments or repairs to the door, control panel, safety interlock switches or any other part of the oven. Repairs should only be undertaken by a qualified service technician.
2. Do not operate the oven when empty. It is best to leave a glass of water in the oven when not in use. The water will safely absorb all microwave energy, if the oven is accidentally started.
3. Do not dry clothes in the microwave oven, which may become carbonized or burned if heated too long.
4. Do not cook food wrapped in paper towels, unless your cook book contains instructions, for the food you are cooking.
5. Do not use newspaper in place of paper towels for cooking.
6. Do not use wooden containers. They may heat-up and char. Do not use ceramic containers which have metallic (e.g. gold or silver) inlays. Always remove metal twist ties. Metal objects in the oven may arc, which can cause serious damage.
7. Do not operate the oven with a kitchen towel, a napkin or any other obstruction between the door and the front edges of the oven, which may cause microwave energy leakage.
8. Do not use recycled paper products since they may contain impurities which may cause sparks and/or fires when used in cooking.
9. Do not rinse the turntable by placing it in water just after cooking. This may cause breakage or damage.
10. Small amounts of food require shorter cooking or heating time. If normal times are allowed they may overheat and burn.
11. Be certain to place the oven so the front of the door is 8 cm or more behind the edge of the surface on which it is placed, to avoid accidental tipping of the appliance.
12. Before cooking, pierce the skin of potatoes, apples or any such fruit or vegetable.
13. Do not cook eggs in their shell. Pressure will build up inside the egg which will burst.
14. Do not attempt deep fat frying in your oven.
15. Remove the plastic wrapping from food before cooking or defrosting. Note though that in some cases food should be covered with plastic film, for heating or cooking.
16. If the oven door is damaged, the oven must not be operated until it has been repaired by a qualified service technician.
17. If smoke is observed keep the oven door closed and switch off or disconnect the oven from the power supply.
18. When food is heated or cooked in disposable containers of plastic, paper or other combustible materials look at the oven frequently to check if the food container is deteriorating.

Q What's wrong when the oven light will not glow?

A There may be several reasons why the oven light will not glow.
Light bulb has blown.
Door is not closed.

Q Does microwave energy pass through the viewing screen in the door?

A No. The holes, or ports, are made to allow light to pass; they do not let microwave energy through.

Q Why does the beep tone sound when a pad on the Control Panel is touched?

A The beep tone sounds to assure that the setting is being properly entered.

Q Will the microwave oven be damaged if it operates empty?

A Yes. Never run it empty or without the glass tray.

Q Why do eggs sometimes pop?

A When baking, frying, or poaching eggs, the yolk may pop due to steam build up inside the yolk membrane. To prevent this, simply pierce the yolk before cooking. Never microwave eggs in the shell.

Q Why is standing time recommended after microwave cooking is over?

A After microwave cooking is finished, food keeps on cooking during standing time. This standing time finishes cooking evenly throughout the food. The amount of standing time depends on the density of the food.

Q Is it possible to pop corn in a microwave oven?

A Yes, if using one of the two methods described below:
1 Popcorn-popping utensils designed specifically for microwave cooking.
2 Prepackaged commercial microwave popcorn that contains specific times and power outputs needed for an acceptable final product.

FOLLOW EXACT DIRECTIONS GIVEN BY EACH MANUFACTURER FOR THEIR POPCORN PRODUCT. DO NOT LEAVE THE OVEN UNATTENDED WHILE THE CORN IS BEING POPPED. IF CORN FAILS TO POP AFTER THE SUGGESTED TIMES, DISCONTINUE COOKING. OVERCOOKING COULD RESULT IN THE CORN CATCHING FIRE.

CAUTION

NEVER USE A BROWN PAPER BAG FOR POPPING CORN. NEVER ATTEMPT TO POP LEFTOVER KERNELS.

Q Why doesn't my oven always cook as fast as the cooking guide says?

A Check your cooking guide again to make sure you've followed directions correctly, and to see what might cause variations in cooking time. Cooking guide times and heat settings are suggestions, chosen to help prevent overcooking, the most common problem in getting used to a microwave oven. Variations in the size, shape, weight and dimensions of the food require longer cooking time. Use your own judgement along with the cooking guide suggestions to test food condition, just as you would do with a conventional cooker.

PLUG WIRING INFORMATION / TECHNICAL SPECIFICATIONS

Warning

This appliance must be earthed

The wires in this mains lead are colored in accordance with the following codes
BLUE ~ Neutral
BROWN ~ Live
GREEN & YELLOW ~ Earth

As the colours of the wires in the mains lead of this appliance may not correspond with the coloured markings identifying the terminals in your plug proceed as follows:

The wire which is colored BLUE must be connected to the terminal which is marked with the letter N or Colored BLACK.

The wire which is colored BROWN must be connected to the terminal which is marked with the letter L or colored RED.

The wire which is colored GREEN & YELLOW or GREEN must be connected to the terminal which is marked with the letter E  or Ground label attached.

Technical Specification

	MS-345SD	
Power Input	230 V AC / 50 Hz	
Output	900 W (IEC705 rating standard)	
Microwave Frequency	2450 MHz	
Outside Dimension	556 mm(W) X 325mm(H) X 444 mm(D)	
Power Consumption	1,200 Watts	

