



# Room Air Conditioner OWNER'S MANUAL

## SPLIT TYPE ROOM AIR CONDITIONER

- Please read carefully and thoroughly this manual before operating this unit.
- Contact the authorized SVC man for repair or maintenance of this unit.
- Contact the installer for installation of this unit.
- The appliance is not intended for use by young children or infirm persons without supervision.
- Young children should be supervised to ensure that they do not play with the appliance.

**MODELS: LS-P0760CL/LS-P0760HL  
 LS-P0962CL/LS-P0962HL  
 LS-S0960CL/LS-S0960HL  
 LS-S1260CL/LS-S1260HL**

ENGLISH.....P.1	- P. 28
ITALIANO .....P.29	- P. 56
ESPAÑOL .....P.57	- P. 84
FRANÇAIS .....P.85	- P. 112
DEUTSCH .....P.113	- P. 140
GREEK.....P.141	- P. 168

Prior to installation, this air-conditioning unit must be submitted for approval by the utility service which provides electricity (EN 60555-3 Norm).



# CONTENTS

<b>SAFETY PRECAUTIONS</b> .....	3
Installation precautions .....	3
Operation precautions .....	4
<b>PRODUCT COMPONENT IDENTIFICATION</b> .....	7
(1) Feature .....	7
(2) Indoor Unit, Outdoor Unit .....	8
(3) Name and Function-Remote Controller .....	9
(4) Remote Controller Preparation .....	10
<b>AIR CONDITIONER OPERATION</b> .....	11
(1) Operation Mode .....	11
(2) Operation Procedure .....	11
(3) Sleep Mode Auto-Control Setting .....	17
(4) Airflow Direction Procedure .....	18
(5) Setting the Present Time .....	19
(6) Timer Setting .....	20
(7) Operation Details .....	22
<b>FORCED OPERATION</b> .....	23
<b>CARE AND MAINTENANCE</b> .....	24
<b>OPERATION TIPS</b> .....	26
<b>BEFORE CALLING FOR SERVICE</b> .....	27
<b>NOTE</b> .....	28

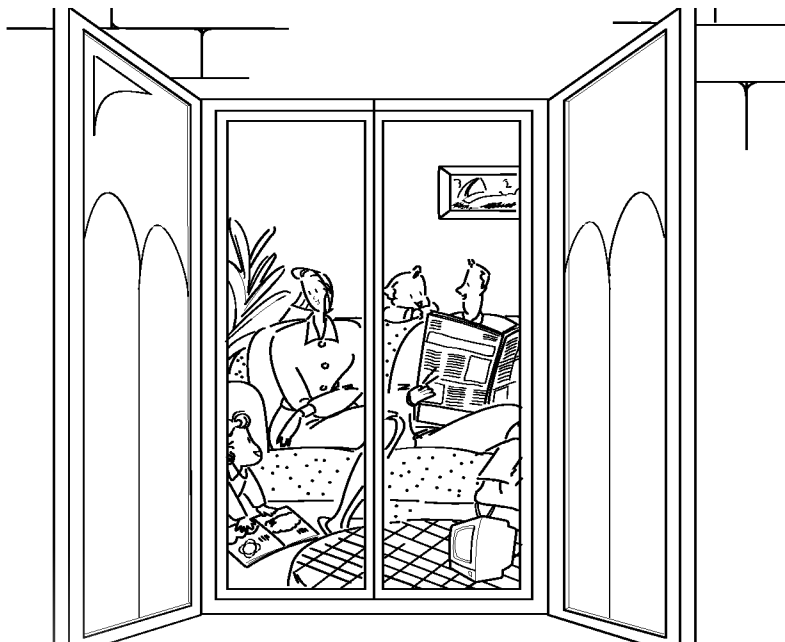

# SAFETY PRECAUTIONS

## Before operating, please read the following "Safety precautions" carefully.

To prevent injury to the user or other people and properties damage, the following instructions must be followed.

- Incorrect operation due to ignoring of instruction will cause harm or damage, the seriousness is classified by the following indications.



**Warning** : This indication shows the possibility of causing death or serious injury.



**Caution** : This indication shows the possibility of causing injury or damage to properties only.

- The items to be followed are classified by the following symbols.



Symbol(with white background) denotes item that is PROHIBITED from doing.



Symbol(with white background) denotes item that is COMPULSORY to be carried out.

## Installation precautions



### WARNING

- **Do not install, remove and reinstall the unit by yourself.**

Improper installation will cause water leakage, electrical shock or fire. Please consult authorized dealer or specialist for the installation work.



### CAUTION

Please confirm the following important points when installation.

- **This room air conditioner must be earthed.**



It may cause electrical shock if grounding is not perfect.

- **Do not install the unit at place where leakage of flammable gas may occur and/or in an explosive atmosphere.**



In case of gas leaks and accumulates at the surrounding of the unit, it may cause fire ignition.

- **Confirm drainage piping is connected properly.**



If it is not connected perfectly, it may cause water leakage and dampen the furniture.

- The reverse cycle system of the air conditioner is based on the air cooling type heat pump which absorbs heated air from the outdoor unit and discharges it indoor.

Therefore if the outdoor unit is exposed in the very low temperature, specifically below 0°C, the heating capacity drops off rapidly. In this case, we recommend customers not to operate the air conditioner.

The temperature described on the labels is measured based on an international standard I.S.O.

	INDOOR	OUTDOOR	
	D.B	D.B	W.B
TEMP.	20±1 °C	7±1 °C	6±1 °C

## Operation precautions



### WARNING

#### Plug in the power plug properly.

- Otherwise, it will cause electrical shock or fire due to heat generation or electrical shock.

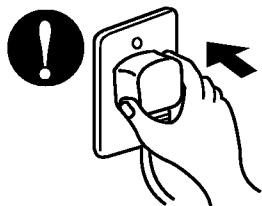

#### Do not operate or stop the unit by inserting or pulling out the power plug.

- It will cause electrical shock or fire due to heat generation.

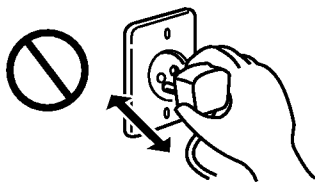

#### Do not damage or use an unspecified power cord.

- It will cause electrical shock or fire.

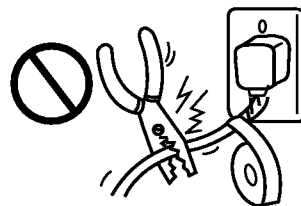

#### Do not modify power cord length or to share the single outlet with other appliances.

- It will cause electrical shock or fire due to heat generation.

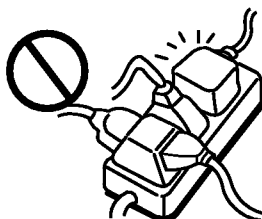

#### Do not operate with wet hand.

- It may cause electrical shock.

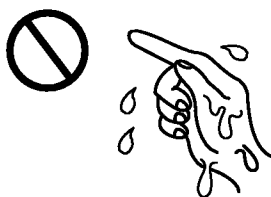

#### Do not insert your finger or stick, etc. into the air inlet/air outlet.

- Since the fan rotates at high speed, this may cause an injury.

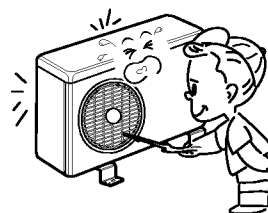

#### Do not expose the skin to cool air directly for long time.

- This could damage your health.

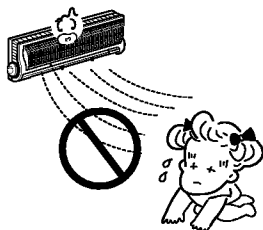

#### When an abnormality (smell of burning, etc) occurs, stop the air conditioner, and disconnect the power plug or turn off the breaker.

- If the unit continues to be operated in an abnormal condition, it may cause a fire, trouble, etc. In this case, consult your dealer.

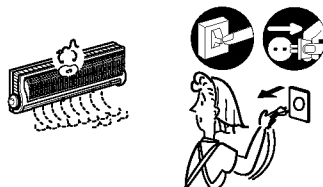

#### Repair or relocation should not be done by the customer.

- If this is done in correctly, it may cause a fire, electric shock, injury by dropping of the unit, water leakage, etc. Consult your dealer.

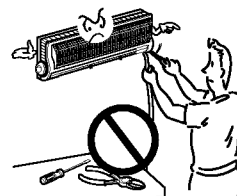



# CAUTION

**When the air filter is to be removed, do not touch the metalparts of the indoor unit.**

- It may cause an injury.

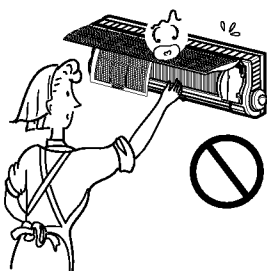

**Do not clean the air conditioner with water.**

- Water may enter the unit and degrade the insulation. It may cause an electric shock.

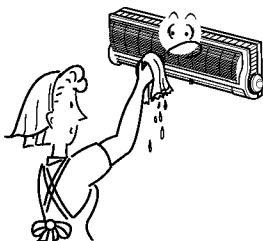

**Ventilate well when used together with a stove, etc.**

- An oxygen shortage may occur.

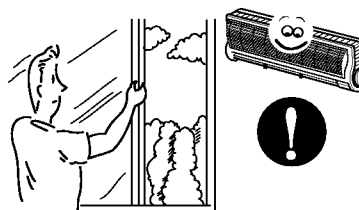

**When the unit is to be cleaned, switch off, and turn off the breaker.**

- Since the fan rotates at high speed during operation, it may cause an injury.

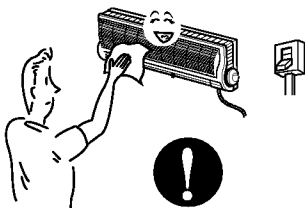

**Do not put a pet or house plant where will be exposed to direct air flow.**

- This could injure the pet or plant.

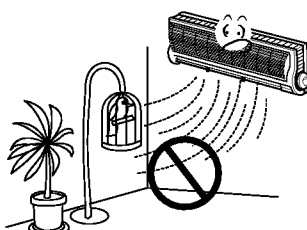

**Do not use for special purposes.**

- Do not use this air conditioner to preserve precision devices, food, animal, plants and art objects. It may cause deterioration of quality, etc.

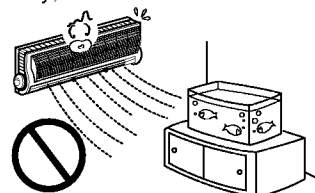

**Do not operate switches with wet hands.**

- It may cause an electric shock.

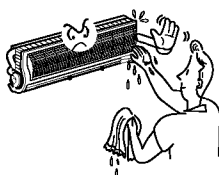

**Do not apply an insecticide or flammable spray.**

- It may cause a fire or deformation of the cabinet.

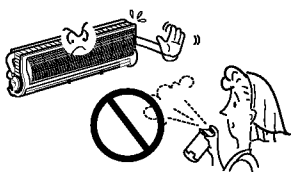

**Do not put a stove, etc. where is exposed to direct air flow.**

- It may cause imperfect combustion.

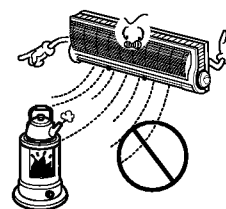



## CAUTION

- It may cause an injury.

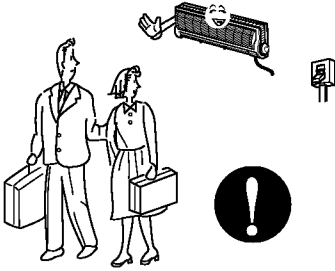

- In the cooling mode, if it is operated in a room with high humidity (80%r.h. or more) for a long time, water condensed in the air conditioner may drop and may wet and spoil furniture, etc.



- It may cause an injury through dropping or falling down.

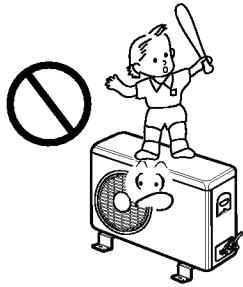

- It may cause an injury, etc. by falling down.

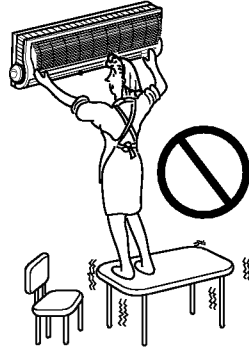

- The unit may drop or fall down and cause an injury.

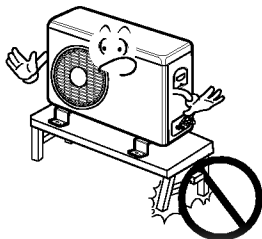

## For installation



## WARNING

- Consult your dealer for installing the air conditioner.



## CAUTION

- Do not connect a grounding wire to a gas pipe, water pipe, lightning rod or ground wire of a telephone.

If a grounding is incorrect, it may cause an electric shock.



**Install an earth leakage breaker depending on the place where the air conditioner is to be installed (humid place, etc.)**

- If the earth leakage breaker is not installed, it may cause an electric shock



- If gas leaks and collect around the unit, it may cause an explosion.

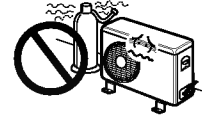

- If the drainage route is incomplete, water may drop from the unit. It may wet and spoil furniture.

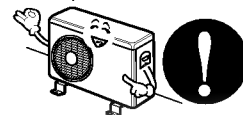

# PRODUCT COMPONENT IDENTIFICATION

## ↙A **Soft Dry Operation Mode**(page 13)

This mode is designed to dehumidify without overcooling.

## ↙B **Natural wind by CHAOS logic**(page 22)

This mode automatically controls the indoor fan speed and creates the feeling of a pleasant breeze like a natural wind by CHAOS logic.

## ↙C **Auto Operation**(page 15)

In selecting this mode of operation, the setting temperature, indoor fan speed, and the desired operation mode are automatically set by Fuzzy rule on the basis of sensing the room temperature.

During Auto Operation, the vertical louver swings up and down automatically in according to 1/f rhythm. Pressing the Airflow Direction Control Button will set the louvers as the desired position. If you want to go on with the 1/f swing of vertical the louver, press again the Airflow Direction Control Button.

## ↙D **ON/OFF Dual Timer Setting**(page 21)

You can program the room air conditioner to turn itself on or off so as to ensure you maximum comfort when you return from being away.

## ↙E **Sleep Mode Auto Control**(page 17)

A touch of the Sleep Mode Button automatically controls the indoor fan speed, and adjusts the setting temperature to create a more comfortable sleep.

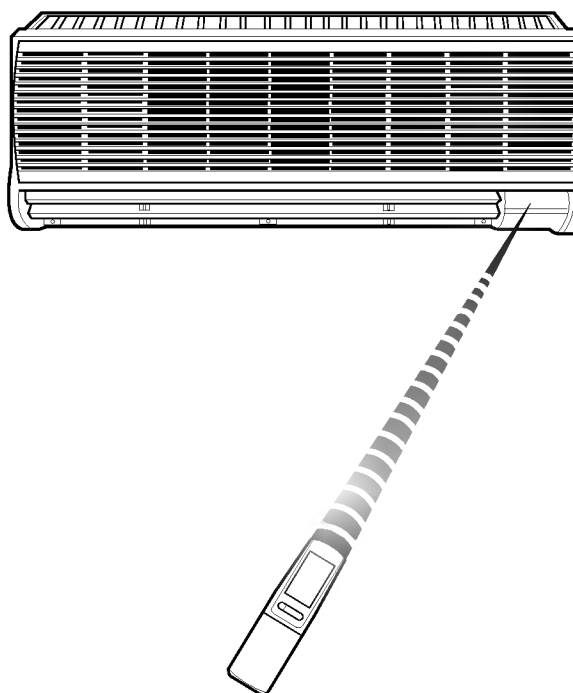

**Wireless Remote Controller puts all functions at your fingertips.**

### **CAUTION**

#### **of handling the Remote Controller**

- Aim at the signal receptor on the room air conditioner so as to operate.
- The remote control signal can be received at a distance of up to about 7m.
- Be sure that there are no obstructions between the remote controller and the signal receptor.
- Do not drop or throw the remote controller. Do not place the remote controller in a location exposed to direct sunlight, or near the heating unit, or any other heat source.
- Block a strong light over the signal receptor with a curtain or etc. so as to prevent the abnormal operation.  
(ex:electronic quick start, ELBA, inverter type fluorescent lamp)

## (2) Indoor Unit, Outdoor Unit

### Indoor Unit

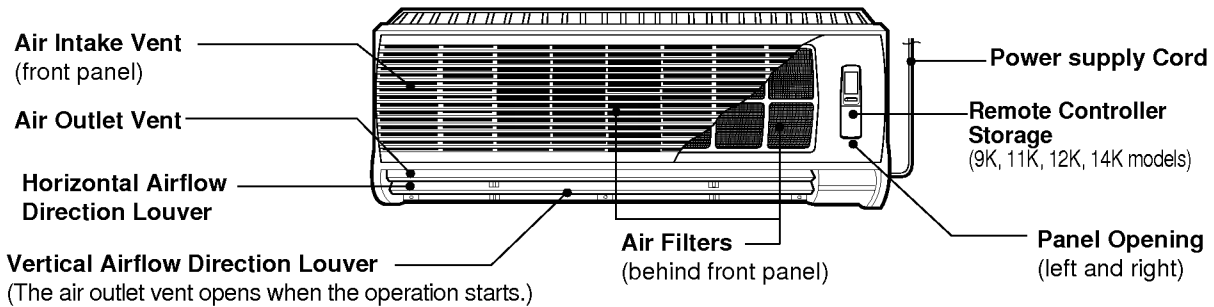

### Indoor unit controls and indicators

**Open the front panel**  
Press the panel to open (left and right side of front panel) and open the panel upward.

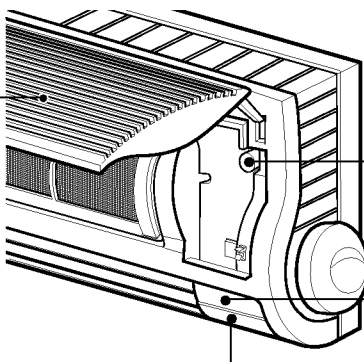

#### Forced Operation Button

Used for operation when the remote controller cannot be used.  
(When operation is stopped by the remote controller without removing power plug, the room air conditioner consumes approximately 2W of electricity.)

#### Signal Receptor

Receives the signals from the remote controller.  
(Signal receiving sound: two short beeps or one long beep.)

#### Operation Indication Lamps

- ⓘ On : Lights up during the air conditioner operation.
- ☆ Sleep Mode : Lights up during Sleep Mode Auto operation.
- 🕒 Timer : Lights up during timer operation.
- ❄️ Deice Mode : Lights up during Deice Mode operation.  
(Blinks on and off during hot start)  
(Heat Pump Only)
- OUT DOOR : Lights up during the compressor operation. (Cooling Only)

### Outdoor Unit

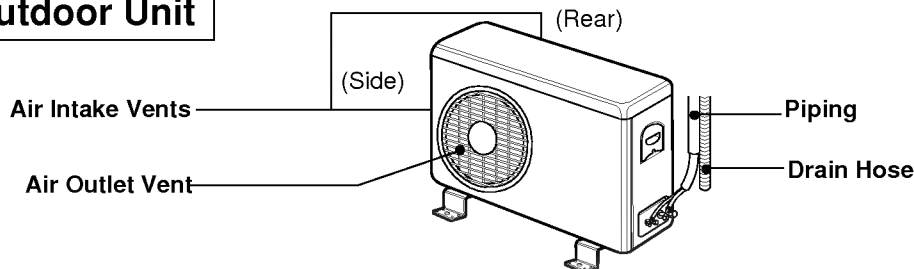



### (3) Name and Function-Remote Controller

#### Remote Controller

##### Signal transmitter

Transmits the signals to the room air conditioner.

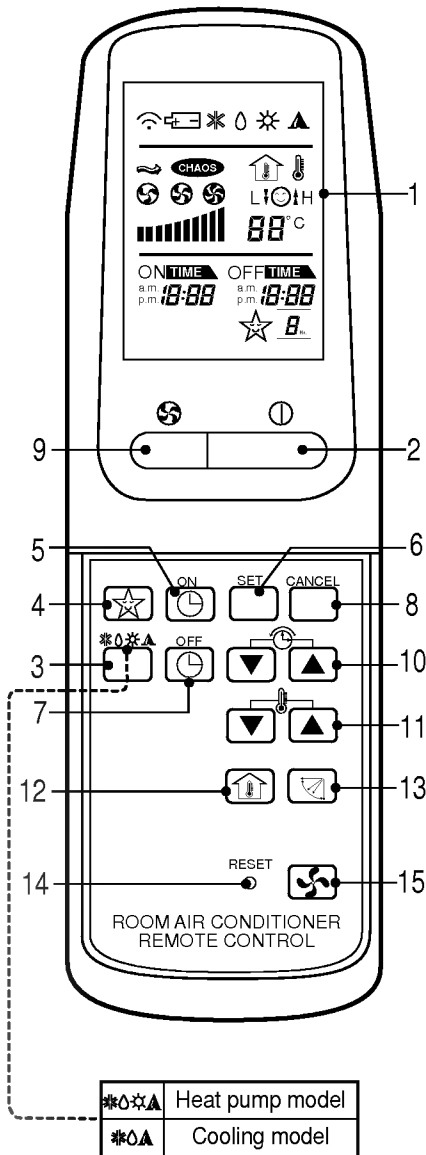

- ↙A **Operation display**  
Displays the operation conditions.
- ↙B **Start/Stop Button**  
Operation starts when this button is pressed, and stops when the button is pressed again.
- ↙C **Operation Mode Selection Button**  
Used to select the operation mode.
  - Cooling Operation Mode.
  - Soft Dry Operation Mode.
  - Heating Operation(Heat Pump Only).
  - Auto Operation Mode.
- ↙D **Sleep Mode Auto Button**  
Used to set Sleep Mode Auto Operation.
- ↙E **ON Timer Button**  
Used to set the time of starting operation.
- ↙F **Timer Set Button**  
Used to set the timer until the desired time is obtained.
- ↙G **OFF Timer Button**  
Used to set the time of stopping operation.
- ↙H **Timer CANCEL Button**  
Used to cancel the timer operation.
- ↙I **Indoor Fan Speed Selector**  
Used to select the desired fan speed.
- ↙J **Time Setting Button**  
Used to adjust the time.
- ↙K **Room Temperature Setting Button**  
Used to adjust the room temperature.
- ↙L **Room Temperature Checking Button**  
Used to check the room temperature.
- ↙M **Airflow Direction Control Button**  
Used to set the desired airflow direction.
- ↙N **Reset Button**
- ↙O **Fan Operation Button (Cooling only)**  
Used to operate the indoor fan only.

## How to store the remote controller (9K, 11K, 12K, 14K Models)

**1** Press the left and the right side to open the front panel upward.

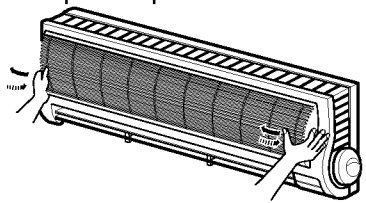

**2** Store the remote controller.  
(Remove it when using.)

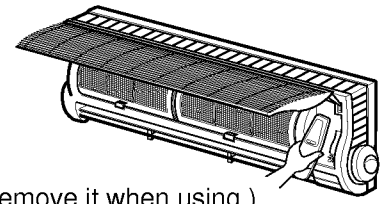

**3** Press the left and the right side to close the front panel.

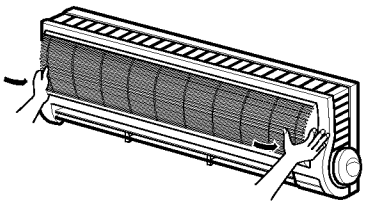

## How to mount onto a wall All Models

**1** Use the screws to secure the holder to the wall.

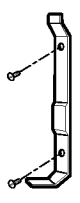

Confirm that the remote control signals can be received from this location.

**2** To attach the remote controller to the holder.

(1) Hook



(2) Press

**3** To remove.

(1) Pull

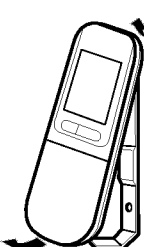

(2) Unhook

## How to insert batteries

**1** Remove the cover from the back of the remote controller.

- Slide the cover according to the arrow direction.

**2** Insert the two batteries.

- Be sure that the (+) and (-) directions are correct.
- Be sure that both batteries are new.

**3** Re-attach the cover.

- Slide it back into position.

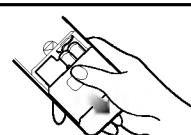
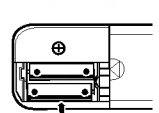
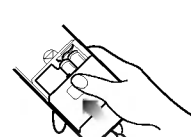
- Do not use rechargeable batteries, such batteries differ from standard dry cells in shape, dimensions, and performance.
- Remove the batteries from the remote controller if the air conditioner is not going to be used for some long time.

# AIR CONDITIONER OPERATION

## (1) Operation Mode

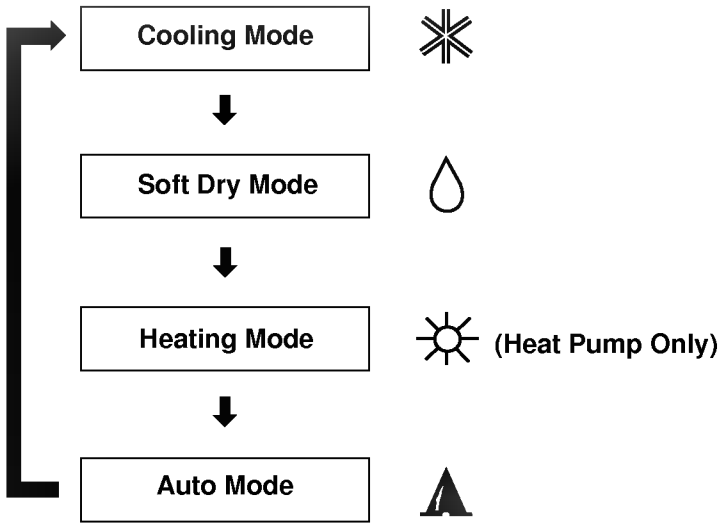

## (2) Operation Procedure

- 1st** Start/Stop Button
- 2nd** Operation Mode Selection Button
- 3rd** Room Temperature Setting Button
- 4th** Indoor Fan Speed Selection Button

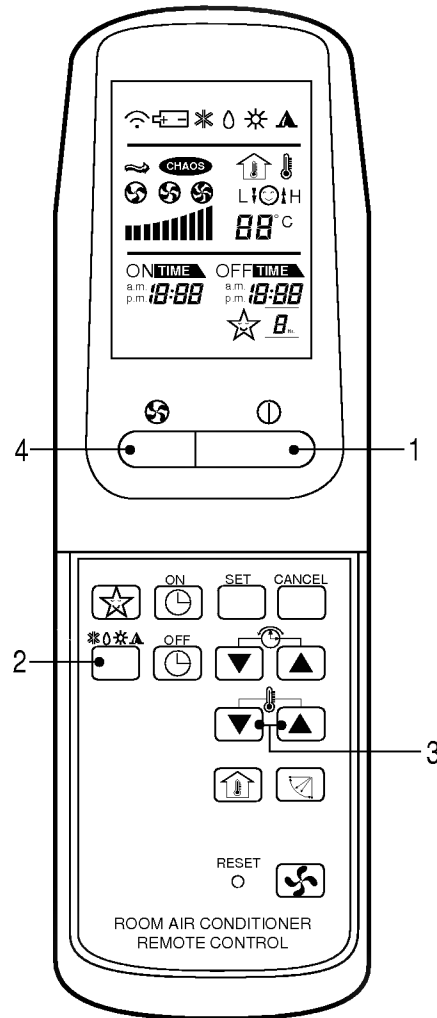

## ➤ A Cooling Operation Mode

(① LED lamp ON)

**1** Press the Start/Stop Button.

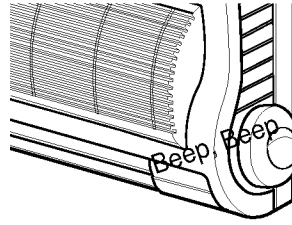
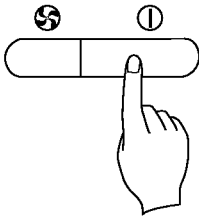

- Two short beeps will sound and the operation lamp will light up.

**2** Select Cooling Operation.

Press the Operation Mode Selection Button.

Each time the button is pressed, the operation mode is shifted in the arrow direction.

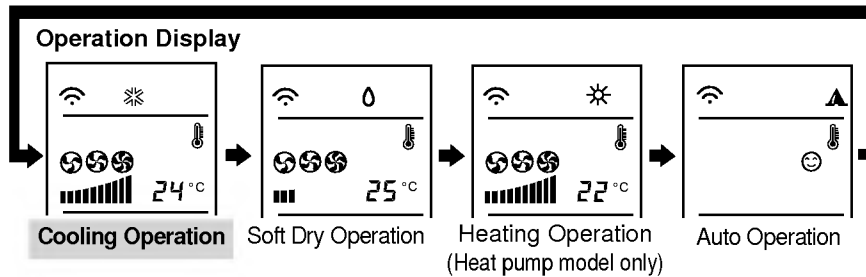
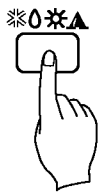

**3** Set the temperature.

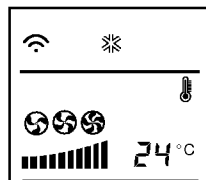

- The temperature can be set within a range of 18°C ~ 30°C by 1°C.

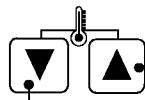

- To raise the Temperature
- To lower the Temperature

**4** Set the fan speed.

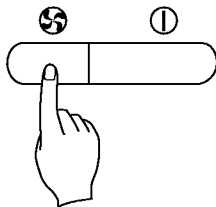

- Select the fan speed in four steps - low, medium, high, CHAOS.

- The display shows high fan speed.

- Each time the button is pressed, the fan speed mode is shifted.

## ➤ B Soft Dry Operation Mode

This mode dehumidifies without overcooling.

(① LED lamp ON)

**1** Press the Start/Stop Button.

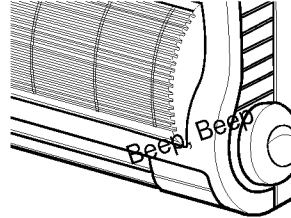
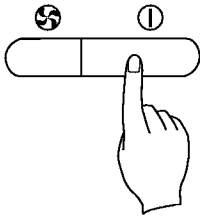

- Two short beeps will sound and the operation lamp will light up.

**2** Select Soft Dry Operation.

Press the operation Mode Selection Button.

Each time the button is pressed, the operation mode is shifted in the arrow direction.

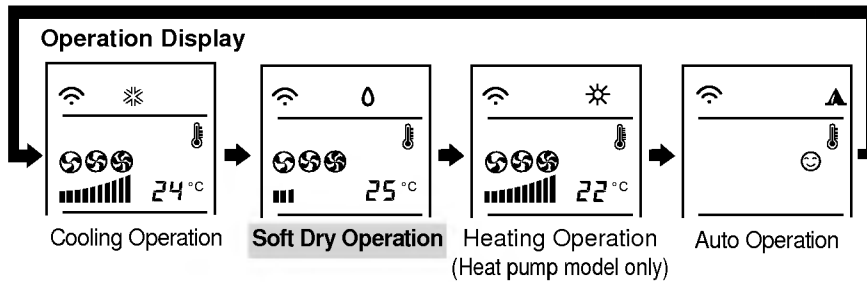
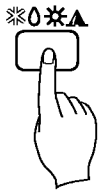

**3** Set the Temperature lower than the room temperature.

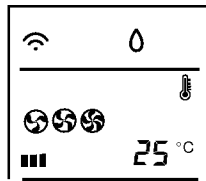

- The temperature can be set within a range of 18°C~30°C by 1°C.

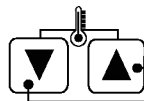

To raise the Temperature  
To lower the Temperature

**4** During Dry Operation

- The indoor fan speed is automatically set to the low, so the shift of the indoor fan speed is impossible because of already being set to the best speed for Dry Operation by Micom Control.
- The indoor fan may be stopped not so as to be the room overcooling.

## ◀ Heating Operation Mode

(① LED lamp ON)

**1** Press the Start/Stop Button.

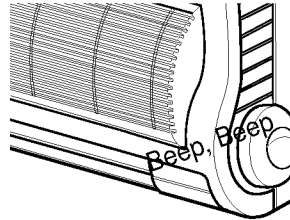
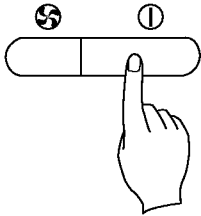

- Two short beeps will sound and the operation lamp will light up.

**2** Select Heating Operation.

Press the Operation Mode Selection Button.

Each time the button is pressed, operation mode is shifted in the arrow direction.

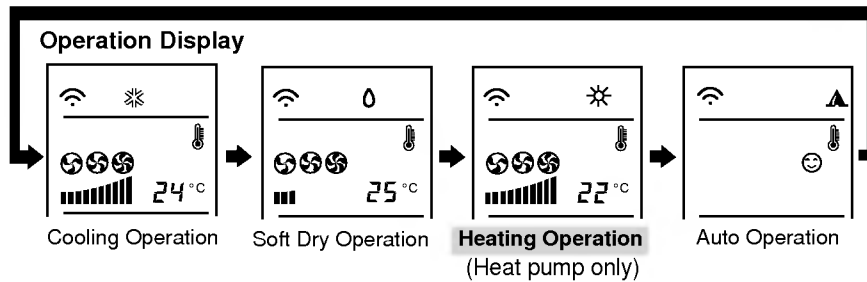
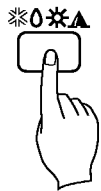

**3** Set the temperature.

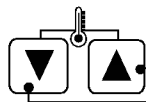
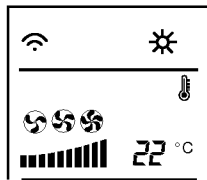

To raise the Temperature  
To lower the Temperature

- The temperature can be set within a range of 16°C~30°C by 1°C.

**4** Set the fan speed.

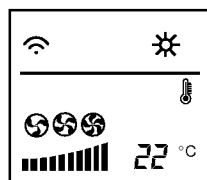
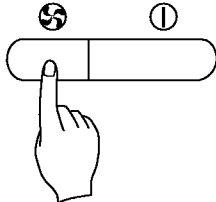

- Each time the button is pressed, the fan speed mode is shifted.

- Select the fan speed in four steps - low, medium, high, CHAOS.
- The display shows high fan speed.

## ▷D Auto Operation Mode

(① LED lamp ON)

### 1 Press the Start/Stop Button.

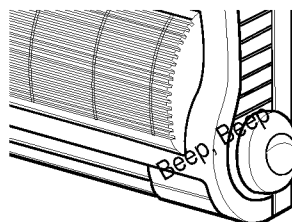
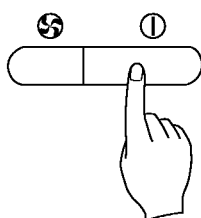

- Two short beeps will sound and the operation lamp will light up.

### 2 Select Auto Operation.

Press the Operation Mode Selection Button.

Each time the button is pressed, the operation mode is shifted in the arrow direction.

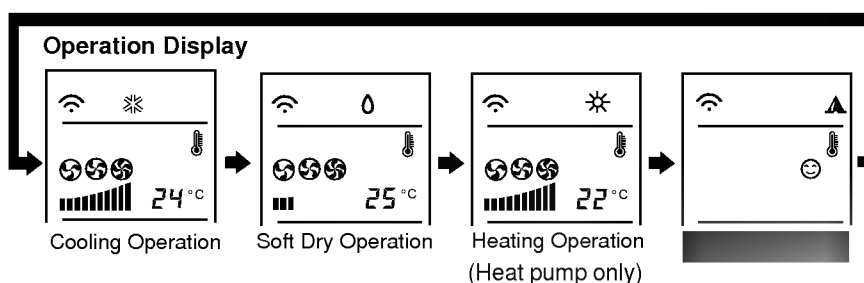
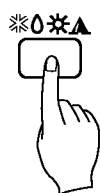

### 3 Set the temperature.

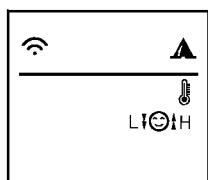

- The desired operation mode and the setting temperature and the fan speed are automatically set by Fuzzy rule on the basis of sensing the room temperature.

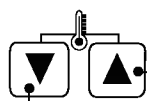

— To raise the Temperature  
— To lower the Temperature

### 4 During Auto Operation.

- It is impossible to switch the indoor fan speed during Auto Operation because of being already set to the best position by Fuzzy rule.
- It is possible to press the room temperature setting button only two times so as to change the automatically setting temperature.
- If the room air conditioner is not operating as desired, switch to cooling mode or other mode.

## Fan Operation

(① LED lamp ON)

**1** Press the Start/Stop Button.

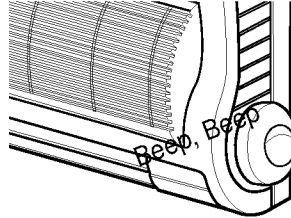
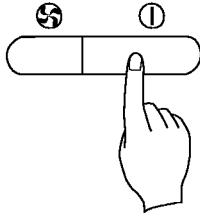

- Two short beeps will sound and the operation lamp will light up.

**2** Select Fan Operation Button.

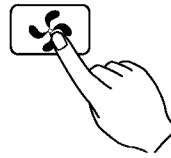

**3** Each time Indoor Fan Speed Selector is pressed, the fan speed mode is shifted in the arrow direction.

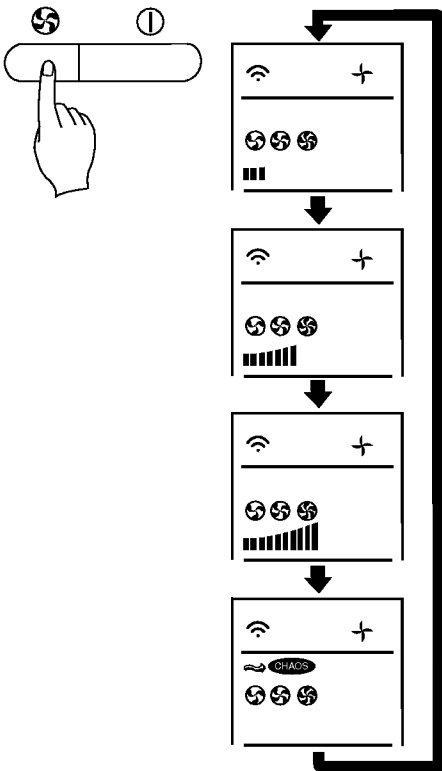

- Fan speed is low.

- Fan speed is medium.

- Fan speed is high.

- Natural wind by CHAOS logic:  
The indoor fan speed is automatically changed from the high to the low, or reversely by CHAOS logic.



### (3) Sleep Mode Auto Control Setting

(☆ LED lamp ON)

#### Remote Controller

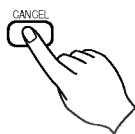
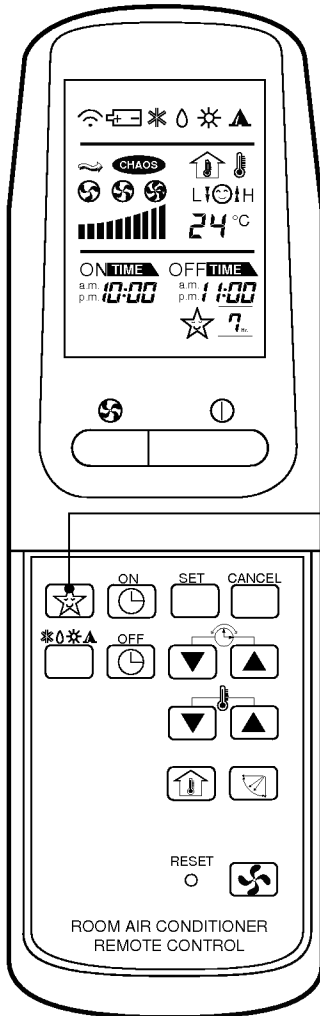

- The Sleep Mode will be operated at a low fan speed(Cooling) or a med. Fan speed prevent the room from being too cold(Cooling) or too hot(Heating) by automatically the setting temperature being raised(Cooling) or being decreased(Heating) for comfortable sleeping.

#### Press the Sleep Mode Auto Button.

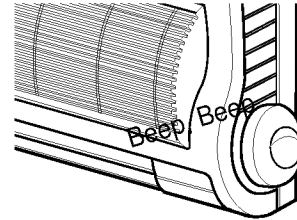

1. Press the Sleep Mode Auto Button and set the time to turn off.
2. Check the Sleep Mode Auto LED of the room air conditioner to light up.
3. The Timer is programmed by 1 hour each pressing the sleep mode auto button from 1 hour to 7 hours.
4. The indoor fan is switched to a low speed.

- The setting temperature will be automatically raised by 1°C 30 minutes later and by 2°C 1 hour later(Cooling) or continued without any change(Heating).
- So as to cancel the Sleep Mode, press the CANCEL button several times until disappear the Sleep Mode(Star pictograph).

## ∟A Vertical Airflow Direction Control

### Airflow Direction Control

The airflow direction can be adjusted as desired by using the remote controller. This is effective when you want to cool yourself directly, such as after taking a bath.

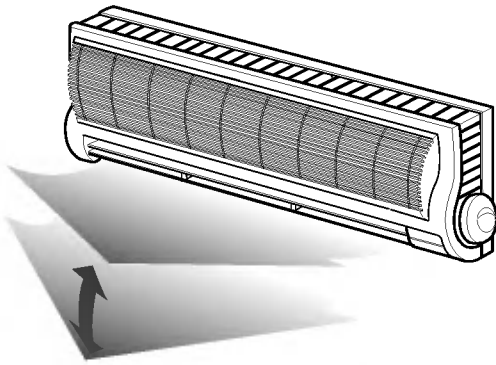

Remote Controller

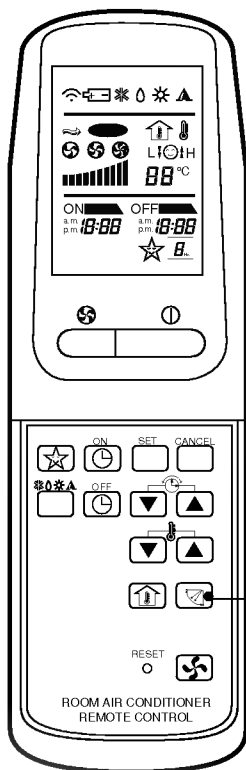

### Airflow Direction Control Button

- 1 Press the Start/Stop Button.  
(Confirm the unit on operation.)

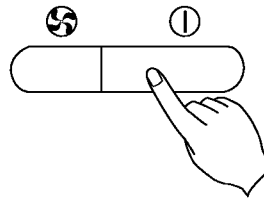

- 2 Press the Airflow Direction Control Button for the vertical louver's swinging up and down automatically.



- 3 Press again the Airflow Direction Control Button to set the vertical louver at the desired airflow direction.



### CAUTION

- Always use the remote controller to adjust the airflow direction. Manually moving the vertical airflow direction louver by hand could cause operation errors.
- When air conditioner operation is stopped, the vertical airflow direction louver will close the air conditioner's air outlet vent.

## Horizontal Airflow Direction Control

- Adjust the horizontal airflow direction by manually moving the horizontal airflow direction louver by hand.

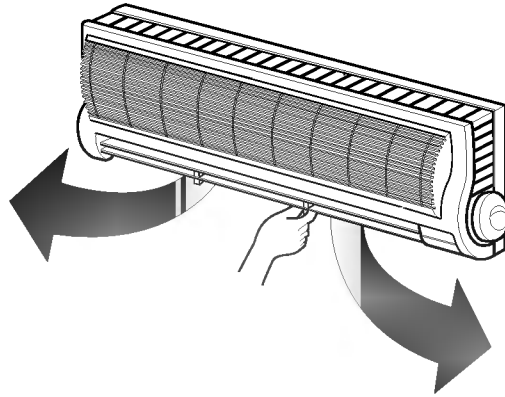

The present time can be set only when pressing the reset button or when replacing batteries for the remote controller.

- Press the Start/Stop Button after pressing the RESET Button or changing batteries for Remote Controller.

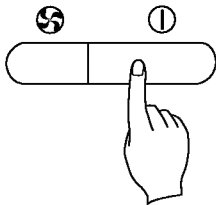

- Press the Time Setting Button until being set the desired time.

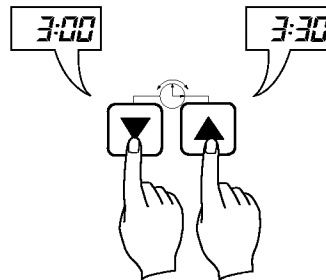

- Press the Time SET Button.



**NOTE :** Check a.m. and p.m. Indicator in setting time.

## (6) Timer Setting

(🕒 LED lamp ON)

### Remote Controller

- 1 ON Timer Button or OFF Timer Button
- 2 Time Setting Button
- 3 Timer SET Button
- 4 Timer CANCEL Button

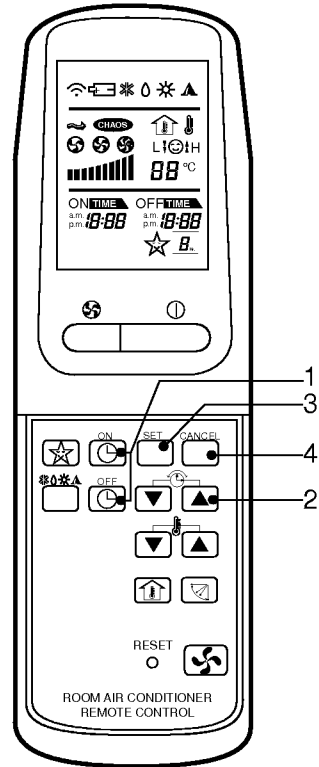

- 1 Press the ON Timer Button or OFF Timer Button.

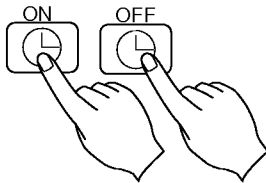

The timer setting will be displayed.

- 2 Change the Timer Setting and press the Timer Set Button.

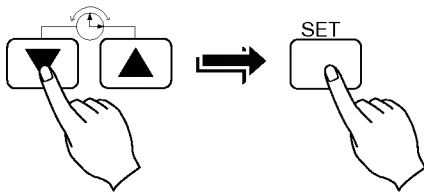

### To cancel the settings

Press the Timer Cancel button.

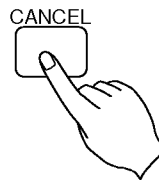

(The timer lamp on the air conditioner and the display will go out.)

### If the settings are cancelled by a power failure.

Press the Start/Stop Button, and then set the timer again as desired time according to Timer Setting Procedure.

# Timer Setting Procedure

**1** Confirm the present time. (Refer page 19)

**2** Press ON Timer Button or OFF Timer Button.

- Select one of the following four types of operation.
- Each time the button is pressed, the operation mode is shifted to the arrow direction.

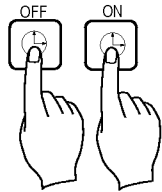

Delay  
OFF Timer

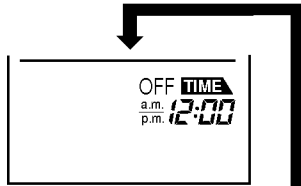

Operation stops at OFF Timer Setting.

Delay  
ON Timer



Operation starts at ON Timer Setting.

Delay OFF  
and ON Timer

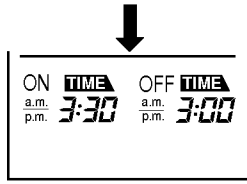

Operation stops at OFF Timer Setting and starts at ON Timer Setting.

Delay ON  
and OFF Timer

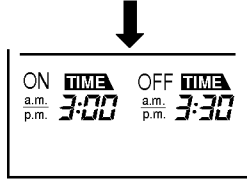

Operation starts at ON Timer Setting and stops at OFF Timer Setting.

**NOTE** : Check a.m. and p.m. Indicator in setting time.

**3** Press the Time Setting Button until being set the desired time.

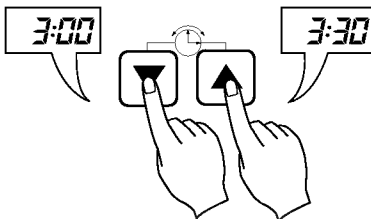

**4** Set the Timer SET Button.

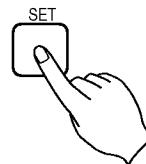

## (7) Operation Details

### • Soft Dry Operation Mode

When the room temperature is higher than the setting temperature, it operates cooling mode as the setting temperature, the setting fan speed (if CHAOS mode, then med.), and then it will be switched to Soft Dry Operation Mode when the room temperature reaches the setting temperature.

In Soft Dry Operation Mode, the indoor fan speed is automatically switched to the low.

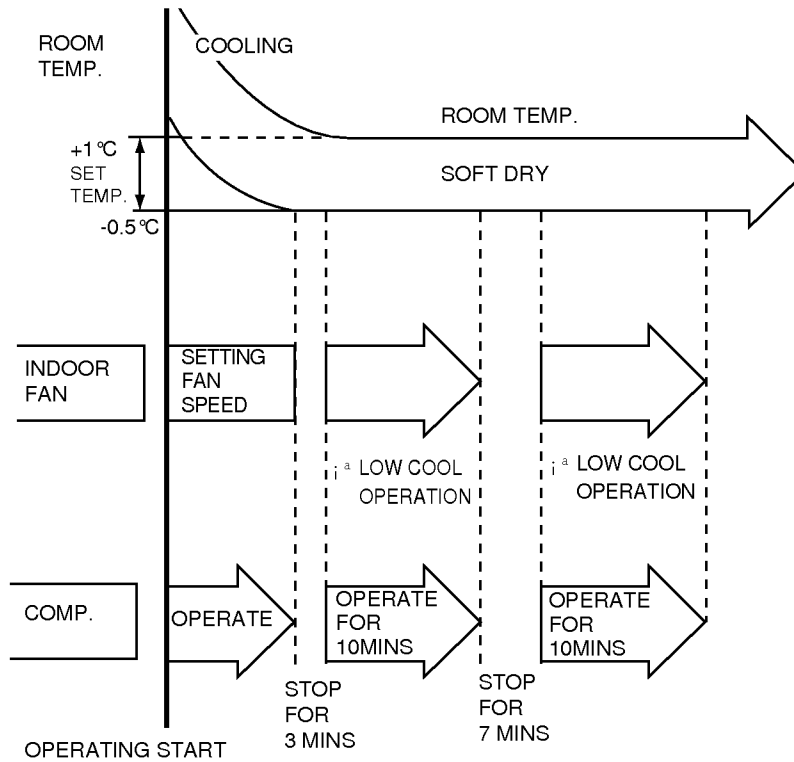

### • Natural wind by the CHAOS logic

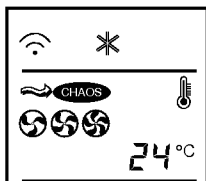

For more fresh feeling than other fan speed mode,

press the Indoor Fan Speed Selector and set to CHAOS mode.

In this mode, the wind blows like natural breeze by automatically fan speed switching from the high to low, or reversely in according to the CHAOS logic.

# FORCED OPERATION

## Operation procedures when the remote controller can't be used.

Open the front panel upward and press the Forced Operation Button.

If you want to stop operation, press again.

During Forced operation, the operating conditions are automatically set as the following:

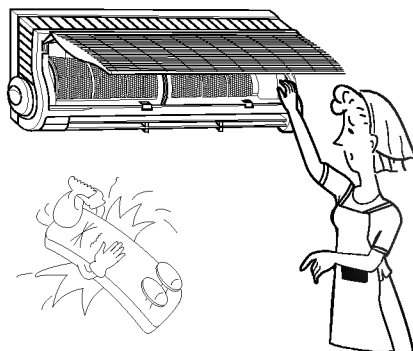

	Cooling Model	Heat pump Model		
		Room Temp. $\geq 24^{\circ}\text{C}$	$24^{\circ}\text{C} > \text{Room Temp.} \geq 21^{\circ}\text{C}$	Room Temp. $< 21^{\circ}\text{C}$
Operating mode	Cooling	Cooling	Soft Dry	Heating
FAN Speed	High	High	Soft Dry Rule	High
Setting Temp.	$22^{\circ}\text{C}$	$22^{\circ}\text{C}$	Air Intake Temperature	$24^{\circ}\text{C}$

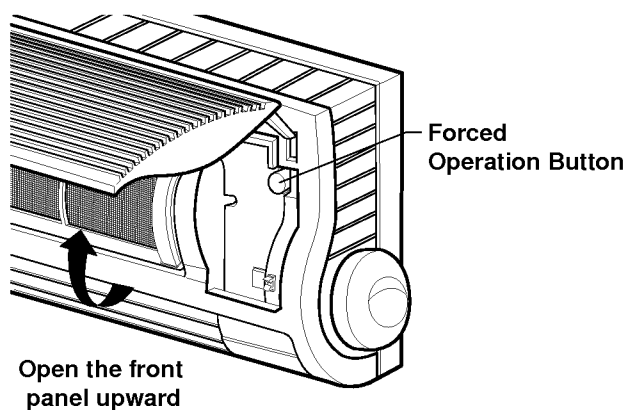

Press the Forced Operation Button.

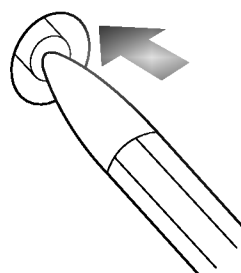

- Press the Forced Operation Button once again to stop operation.

## Helpful information

Airflow speed and cooling capacity

The cooling capacity indicated in the specification is the value when the fan speed is set to high, and the capacity will be lower at low or medium fan speed.

High fan speed is recommended when you wish to cool the room quickly.

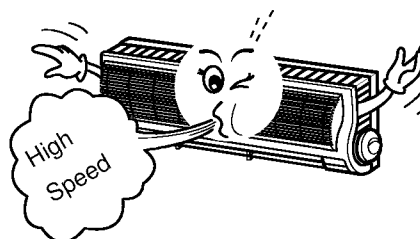

# CARE AND MAINTENANCE

## Before performing any maintenance procedure

- Disconnect the power plug or turn off the breaker.

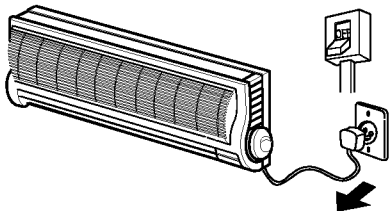

### CAUTION

When the unit is to be cleaned, switch off and disconnect the power plug or turn off the breaker.

Since the fan rotates at high speed during operation, it may cause an injury.

- Clean using soft dry cloth.

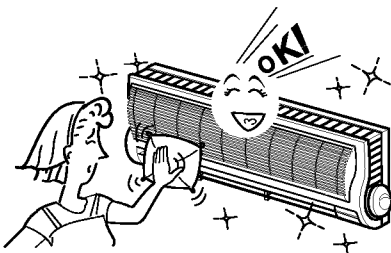

- Never use any of the followings:
  - Water hotter than 40°C.  
Could cause deformation and/or discoloration.
  - Volatile substances.  
Could damage the surfaces of the air conditioner.



## Cleaning the air filter (about once every 2 weeks)

- 1 Remove the air filters.**
  - Take hold of the tab and pull slightly forward to remove the filter.

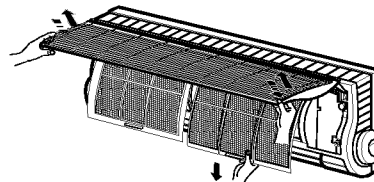

### CAUTION

When the air filter is to be removed, do not touch the metal parts of the indoor unit.

It may cause an injury.

- 2 Clean dirt from the air filter using a vacuum cleaner or by washing with water.**
  - If dirt is conspicuous, wash with a solution of detergent in lukewarm water.
  - If hot water (50°C or more) is used, it may be deformed.

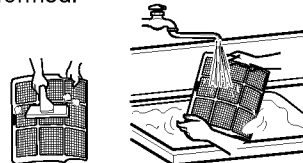

- 3 After washing with water, dry well in the shade.**
  - Do not expose the air filter to direct sunlight or heat from a fire when drying it.

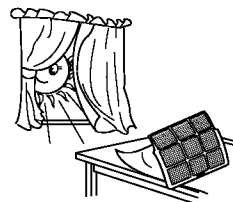

- 4 Install the air filter.**

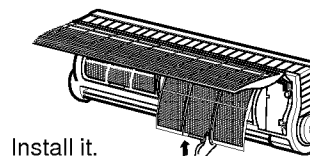

Install it.



## WHEN THE AIR CONDITIONER IS NOT GOING TO BE USED FOR A LONG TIME.

Operate the air conditioner at the following settings for 2 to 3 hours.

(Summer)

• Type of operation : Fan Operation

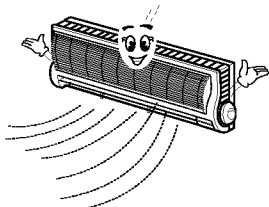

This will dry out the internal mechanisms.

Turn off the breaker, and disconnect the plug.



Turn off the breaker when the air conditioner is not going to be used for a long time.

Dirt may collect and may cause a fire.

Remove the batteries from the remote controller.

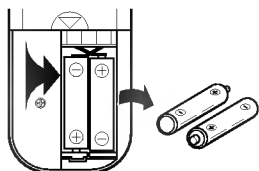

Clean the air filter and install it in the indoor unit.

(Refer to page 24 for cleaning it.)

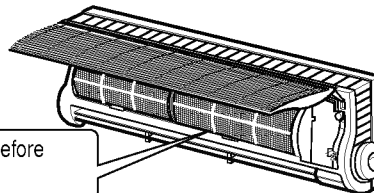

Clean it before installing.

Check that the air inlet and outlet of the indoor/outdoor unit are not blocked.

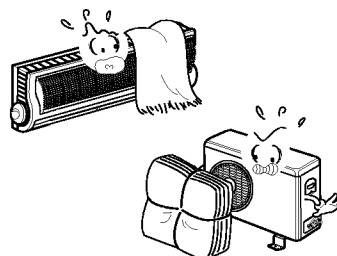

Check that the ground wire is connected correctly. It may be connected to the indoor unit side.



Apply grounding.

Do not connect a grounding wire to a gas pipe, water pipe, lightning rod or ground wire of a telephone. If a grounding is incorrect, it may cause an electric shock.

### Helpful information

The air filters and your electric bill.

If the air filters become clogged with dust, the cooling capacity will drop, and 6% of the electricity used to operate the air conditioner will be wasted.

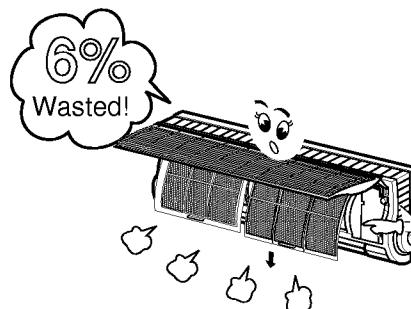

# OPERATION TIPS

This is not good for the health and wastes electricity.

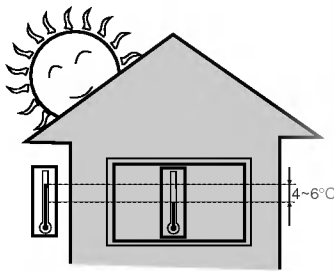

Do not let direct sunshine enter the room when the air conditioner is in operation.

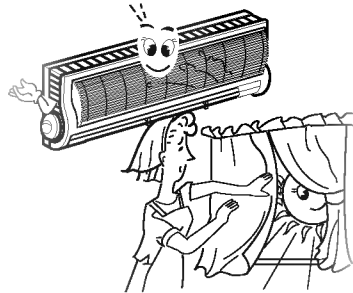

Adjust the vertical and horizontal airflow direction to ensure a uniform temperature in the room.

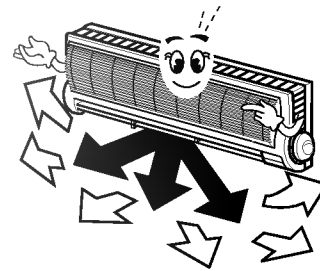

Avoid opening doors and windows as much as possible to keep the cool air in the room.

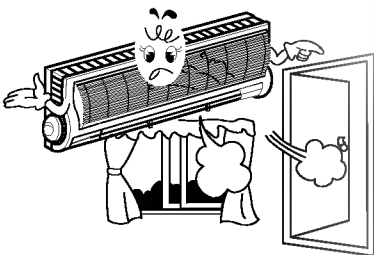

Blockages in the air filter reduce the airflow and lower cooling and dehumidifying effects. Clean at least once every two weeks.

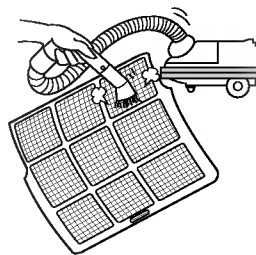

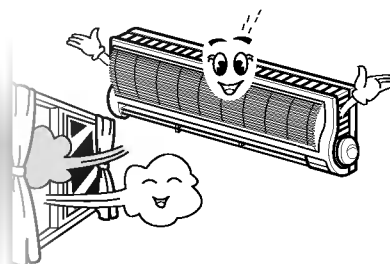

Since windows are kept closed, it is a good idea to open them and ventilate the room now and then.

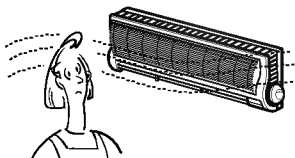
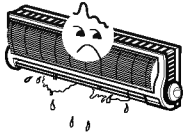
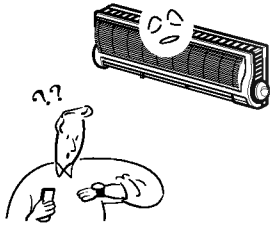
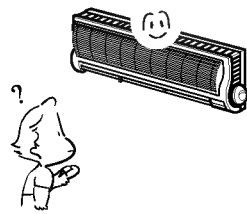
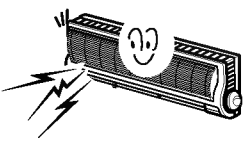

# BEFORE CALLING FOR SERVICE

Check the following points before requesting repairs or service.... If the malfunction persist, please contact your dealer.

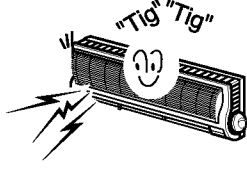
 <ul style="list-style-type: none"> <li>• Have you made a mistake in timer operation?</li> <li>• Has the fuse blown or has the circuit breaker been tripped?</li> </ul>	 <ul style="list-style-type: none"> <li>• Check that this is not a damp smell exuded by the walls, carpet, furniture or cloth items in the room.</li> </ul>	 <ul style="list-style-type: none"> <li>• Condensation occurs when the airflow from the air conditioner cools the warm room air.</li> </ul>	 <ul style="list-style-type: none"> <li>• This is the protector of the mechanism.</li> <li>• Wait about three minutes and operation will begin.</li> </ul>
 <ul style="list-style-type: none"> <li>• Is the air filter dirty? See air filter cleaning instructions.</li> <li>• The room may have been very hot when the room air conditioner was first turned on. Allow time for it to cool down.</li> <li>• Has the temperature been set incorrectly?</li> <li>• Are the indoor unit's air inlet or outlet vents obstructed?</li> </ul>	 <ul style="list-style-type: none"> <li>• For a noise that sounds like water flowing.               <ul style="list-style-type: none"> <li>-This is the sound of freon flowing inside the air conditioner unit.</li> </ul> </li> <li>• For a noise that sounds like the compressed air releasing into atmosphere.               <ul style="list-style-type: none"> <li>-This is the sound of the dehumidifying water being processed inside the air conditioning unit.</li> </ul> </li> </ul>	 <ul style="list-style-type: none"> <li>• Are the batteries depleted?</li> <li>• Are the batteries inserted in the opposite (+) and (-) directions?</li> </ul>	 <ul style="list-style-type: none"> <li>• This sound is generated by the expansion/constriction of the front panel, etc. due to changes of temperature.</li> </ul>

## NOTE

SPLASH PROOF : The outdoor side of this appliance is SPLASH PROOF and the indoor side is ordinary.

