

Safety Precautions

Safety Precautions3

About the Controls on the Air Conditioner

Controls5
 Ventilation6
 Air Direction.....6
 How to Attach Drain Pan....6
 How to Connect a Drain Hose.7

Care and Maintenance

Air filter Cleaning.....7
 How to Attach Front Grille to Cabinet.....7

Features and Installation

Features8
 How to install the unit.....9
 How to use the Reversible Inlet Grille9

Before you call for service...

Normal Operating10
 Abnormal Operation10

FOR YOUR RECORDS

Staple your receipt to this page in case you need it later.
 Write down the model and serial numbers here:

Model #

Serial #

You can find them on a label on the side of each unit.

Dealer's Name

Date Purchased

READ THIS MANUAL

Inside you will find many helpful hints on how to use and maintain your air conditioner properly. Just a little preventive care on your part can save you a great deal of time and money over the life of your air conditioner.

You'll find many answers to common problems in the chart of troubleshooting tips. If you review our chart of **Troubleshooting Tips** first, you may not need to call for service at all.

CAUTION

- Contact the authorized Service technician for repair or maintenance of this unit.
- The air conditioner is not intended for use by young children or infirm persons without supervision.
- Young children should be supervised to ensure that they do not play with the air conditioner.

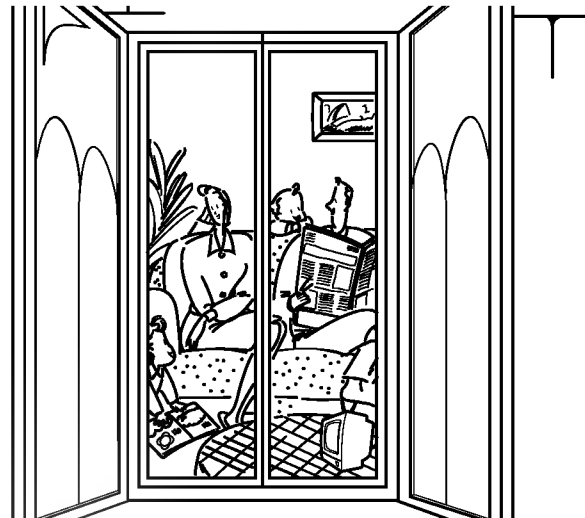

Safety Precautions

To prevent injury to the user or other people and property damage, the following instructions must be followed.

■ Incorrect operation due to ignoring of instruction will cause harm or damage. The seriousness is classified by the following indications.



WARNING

: This symbol indicates the possibility of death or serious injury.



CAUTION

: This symbol indicates the possibility of injury or damage to properties only.

■ Meanings of symbols used in this manual are as shown below.



Be sure not to do.



Be sure to follow the instruction.



WARNING

• Otherwise, it will cause electric shock or fire due to heat generation.

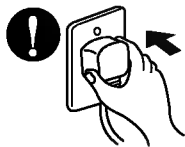

• It will cause electric shock or fire due to heat generation.



• It will cause electric shock or fire.
• If the power cord is damaged, it must be replaced by the manufacturer or an authorized service center or a similarly qualified person in order to avoid a hazard.



• It will cause electric shock or fire due to heat generation.

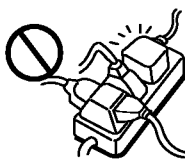

• It will cause electric shock.



• This could damage your health.

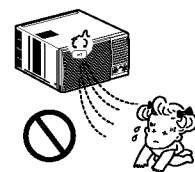



CAUTION

• It may cause an injury.

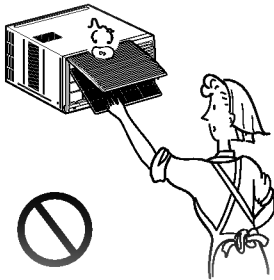

• Water may enter the unit and degrade the insulation. It may cause an electric shock.

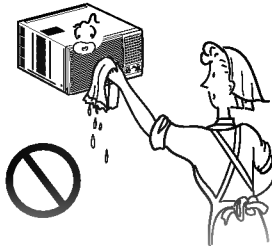

• An oxygen shortage may occur.

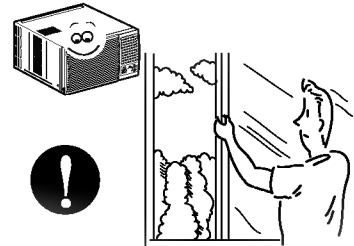

• Since the fan rotates at high speed during operation, it may cause an injury.

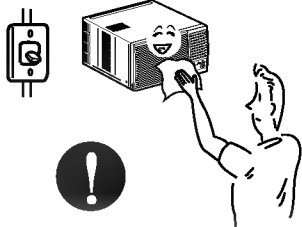

• This could injure the pets or plants.

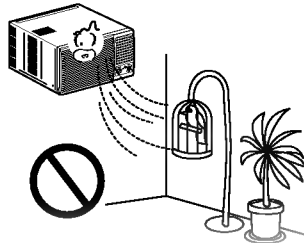

• Do not use this air conditioner to preserve precision devices, food, pets, plants, and art objects. It may cause deterioration of quality, etc.

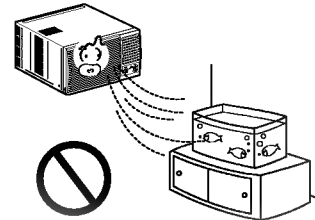

• It may cause an electric shock.

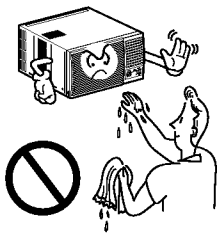

• It may cause a fire or deformation of the cabinet.

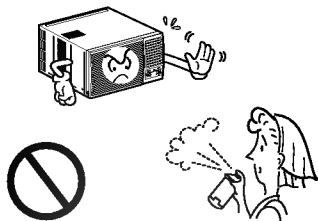

• It may cause imperfect combustion.

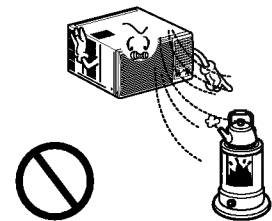

About the Controls on the Air Conditioner

The controls will look like one of the following.



Controls

<p>Operation</p>		<p>OFF (0) : Turns the air conditioner off.</p> <p>MED FAN (⊕) : Permits the medium fan speed operation without cooling.</p> <p>LOW FAN (⊗) : Permits the low fan speed operation without cooling.</p> <p>HIGH COOL (⊛) : Permits cooling with the high fan speed operation.</p> <p>MED COOL (⊙) : Permits cooling with the medium fan speed operation.</p> <p>LOW COOL (⊘) : Permits cooling with the low fan speed operation.</p>
<p>Thermostat</p>		<p>Thermostat will automatically control the temperature of the room. Select higher number for lower room temperature. The temperature is selected by turning the knob to the desired position. The 5 or 6 position is a normal setting for average conditions.</p>

• FOR NORMAL COOLING

1. Turn the Operation Knob to the High Cool from the Low Cool setting.
2. Set the Thermostat control to the desired temperature mark 5 (the mid-point is a good starting position). If the room temperature is not satisfactory after a reasonable time, adjust the control to a cooler or warmer setting, as appropriate.

• FOR MAXIMUM COOLING

1. Turn the Operation Knob to the High Cool setting.
2. Set the Thermostat control to the largest 9 temperature mark.

• FOR QUIETER OPERATION

1. Turn the Operation Knob to the Low Cool setting.
2. Set the Thermostat control as needed.

• AUTO SWING

- ON (Δ) : Air swing is operated while OPERATION knob is set to the COOL position.
- OFF (↑) : Stops the operation of air swing.

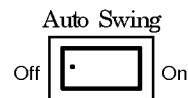

When the air conditioner has been performed its cooling operation and is turned off or set to the fan position, wait at least 3 minutes before resetting to the cooling operation again.

Additional controls and important information.

Ventilation

The ventilation lever must be in the CLOSE position in order to maintain the best cooling conditions. When fresh air is necessary in the room, set the ventilation lever to the OPEN position. The damper is opened and room air is drawn out.

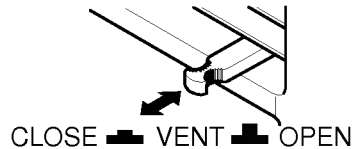

NOTE: Before using the ventilation feature, position the lever, as shown. First, pull down part (A) to horizontal line with part (B).

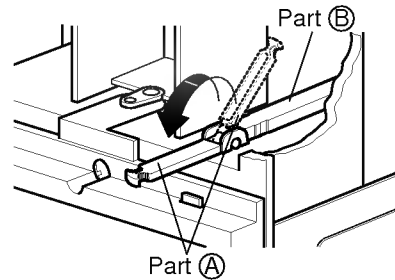

Air Direction

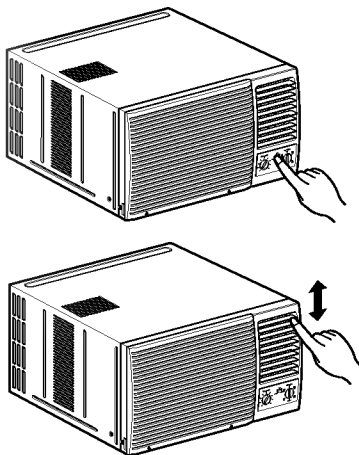

The direction of air can be controlled wherever you want to cool by adjusting the horizontal louver and the vertical louver.

• HORIZONTAL AIR-DIRECTION CONTROL

To control horizontal direction of air flow, set to the ON position the air-swing switch and the air flow will be swept horizontally by the automatic air-swing system.

If you want to stop the air flow from moving, switch off the air swing switch at the desired position of the vane.

• VERTICAL AIR-DIRECTION CONTROL

The vertical air direction is adjusted by moving the horizontal louver.

How to Attach Drain Pan

The air conditioner employs a proper drain method whereby the condensed water (moisture removed from the air) is drained to the outside.

In very humid weather, (and for reverse cycle models in the reverse mode) excessive condensate water removed from the air may cause some water to collect. To remove this excess water you can install the drain pan as detailed below.

1. Take the drain pan which is located in the air discharge.
2. Remove the hole rubber from the base-pan (for some models).
3. Install the drain pan to the right corner of the cabinet with 4 (or 2) screws.
4. Connect the drain hose to the outlet located at the bottom of the drain pan. You can purchase the drain hose or tubing locally to satisfy your particular needs. (Drain hose is not supplied).

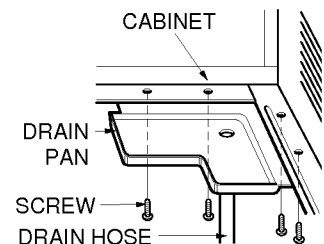

How to Connect a Drain Hose

A drain hole is provided at the rear of the air conditioner unit.

Select a drain method according to the following.

1. Remove the hole rubber from the base-pan. (for some models)
2. Connect a drain hose to the drain pipe as shown in Fig. 1.
3. Or connect a pipe elbow to the drain pipe, then connect a drain hose to the pipe elbow as shown in Fig. 2.

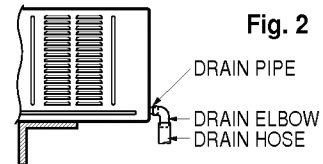
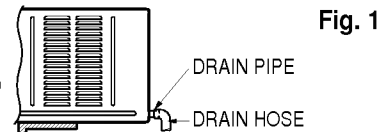

Care and Maintenance

TURN THE AIR CONDITIONER OFF AND REMOVE THE PLUG FROM THE POWER OUTLET.

Air Filter Cleaning

The air filter should be checked at least twice a month to see if cleaning is necessary. Trapped particles in the filter will build up and block the airflow. This reduces the cooling capacity and also causes an accumulation of frost on the cooling coils.

1. Open the inlet grille upward by pulling out the bottom of the inlet grille.(a)
In another case, you can open the inlet grille downward by pulling out the top of the inlet grille.(b)
2. Remove the air filter from the front grille assembly by pulling the air filter up or down slightly.
3. Wash the filter using lukewarm water below 40 °C (104 °F).(c)
4. Gently shake the excess water from the filter completely. Replace the filter.

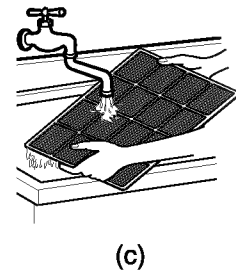
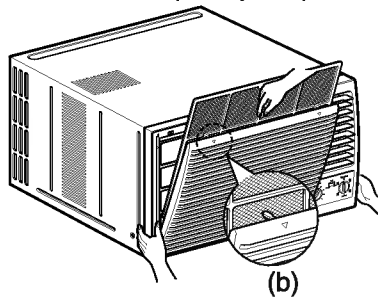
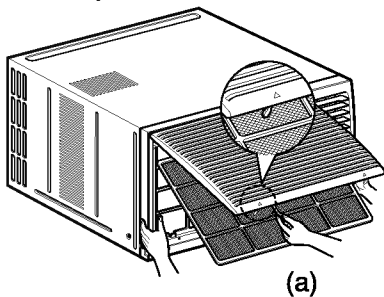

NOTE: Mark Δ of inlet grille means opening direction.

How to Attach Front Grille to Cabinet

1. Pull down front grille from the cabinet top.
2. Push front grille's tips toward the cabinet in order to insert front grille's tabs into the cabinet.
3. Open the inlet grille.
4. Tighten the screw through the front grille into the plate of the evaporator.
5. Close inlet grille.

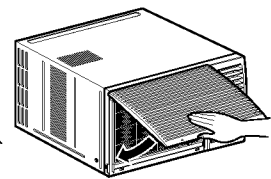
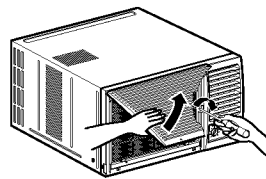
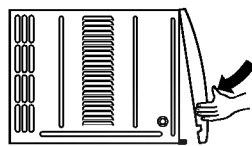
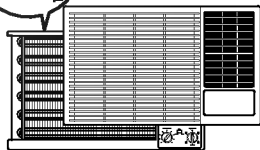

Features and Installation

Learning parts name prior to installation will help you understand the installation procedure.

Features

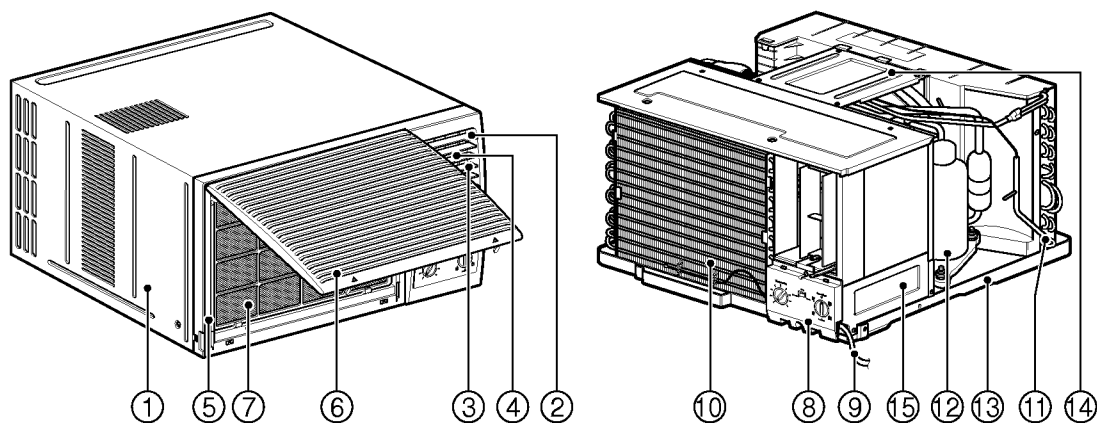

- | | |
|--|-------------------|
| 1. CABINET | 7. AIR FILTER |
| 2. HORIZONTAL AIR DEFLECTOR
(VERTICAL LOUVER) | 8. CONTROL BOARD |
| 3. VERTICAL AIR DEFLECTOR
(HORIZONTAL LOUVER) | 9. POWER CORD |
| 4. AIR DISCHARGE | 10. EVAPORATOR |
| 5. FRONT GRILLE | 11. CONDENSER |
| 6. INLET GRILLE (AIR INTAKE) | 12. COMPRESSOR |
| | 13. BASE PAN |
| | 14. BRACE |
| | 15. COVER CONTROL |

Installation

How to Install the Unit

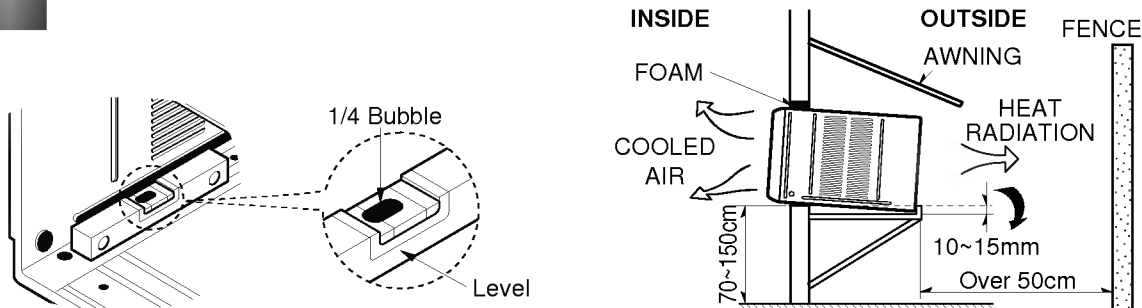

1. To avoid vibration and noise, make sure the unit is installed securely and firmly.
2. Install the unit where the sunlight does not shine directly on the unit.
If the unit receives direct sunlight, build an awning to shade the cabinet.
3. There should be no obstacle, like a fence, within 50cm which might restrict heat radiation from the condenser.
4. To prevent reducing performance, install the unit so that louvers of the cabinet are not blocked.
5. Install the unit a little obliquely outward not to avoid leaking the condensed water into the room (10~15mm or 1/4 bubble with level).
6. Install the unit with its bottom portion 70~150cm above the floor level.
7. Stuff the foam between the top of the unit and the wall to prevent air and insects from getting into the room.
8. The power cord must be connected to an independent circuit. The green wire must be grounded.
9. Connect the drain tube to the base pan hole in the rear side if you need to drain (consult a dealer.)
Plastic hose or equivalent may be connected to the drain tube.

How to Use the Reversible Inlet Grille

The grille is designed to clean the filter both upward and downward.

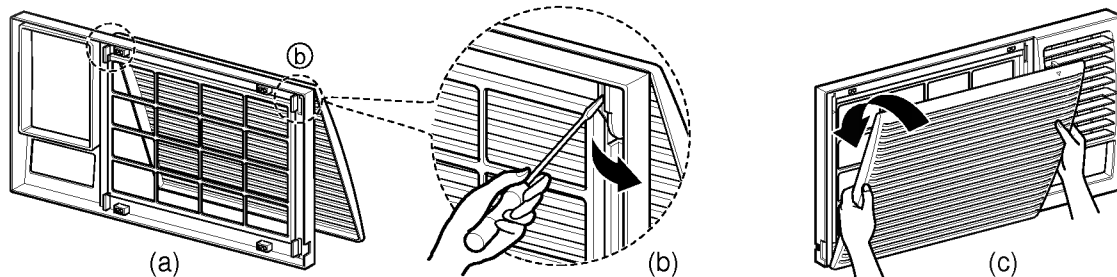

A. Before attaching the front grille to the cabinet, if you want to pull out the filter upward;

1. Open the inlet grille slightly (a).
2. Turn inside out the front grille (a).
3. Disassemble the inlet grille from the front grille with separating the hinged part by inserting a straight type screw-driver tip (b).
4. Then, rotate the inlet grille 180 degrees and insert the hooks into bottom holes of the front grille.
5. Insert the filter and attach the front grille to the cabinet. (Refer to page 7)

B. If you want to pull out the filter downward;

The grille is already designed that way.

Before you call for service...



Troubleshooting Tips

Save time and money! Review the chart below first and you may not need to call for service.

Normal Operating

- You may hear a pinging noise caused by water being picked up and thrown against the condenser on rainy days or when the humidity is high. This design feature helps remove moisture and improve efficiency.
- You may hear the thermostat click when the compressor cycles on and off.
- Water will collect in the base pan during high humidity or on rainy days. The water may overflow and drip from the outdoor side of the unit.
- The fan may run even when the compressor does not.

Abnormal Operation

Air conditioner does not start	■ <i>The air conditioner is unplugged.</i>	• Make sure the air conditioner plug is pushed completely into the outlet.
	■ <i>The fuse is blown/circuit breaker is tripped.</i>	• Check the house fuse/circuit breaker box and replace the fuse or reset the breaker.
	■ <i>Power failure.</i>	• If power failure occurs, turn the operation knob to OFF . When power is restored, wait 3 minutes to restart the air conditioner to prevent tripping of the compressor overload.
Air conditioner does not cool as it should	■ <i>Airflow is restricted.</i>	• Make sure there are no curtains, blinds, or furniture blocking the front of the air conditioner.
	■ <i>The THERMOSTAT may not be set high enough.</i>	• Turn the knob to a higher number. The highest setting provides maximum cooling.
	■ <i>The air filter is dirty.</i>	• Clean the filter at least every 2 weeks. See the operating instructions section.
	■ <i>The room may have been hot.</i>	• When the air conditioner is first turned on you need to allow time for the room to cool down.
	■ <i>Cold air is escaping.</i>	• Check for open furnace floor registers and cold air returns. • Set the air conditioner's vent to the closed position.
Air conditioner freezing up	■ <i>Cooling coils have iced up.</i>	• See Air Conditioner Freezing Up below.
	■ <i>Ice blocks the air flow and stops the air conditioner from cooling the room.</i>	• Set the operation knob at Med Fan or High Cool with the thermostat at 1 or 2 .