



LG **SXS** REFRIGERATOR

User's Guide

Please read this guide thoroughly before operating and keep it handy for reference at all times.

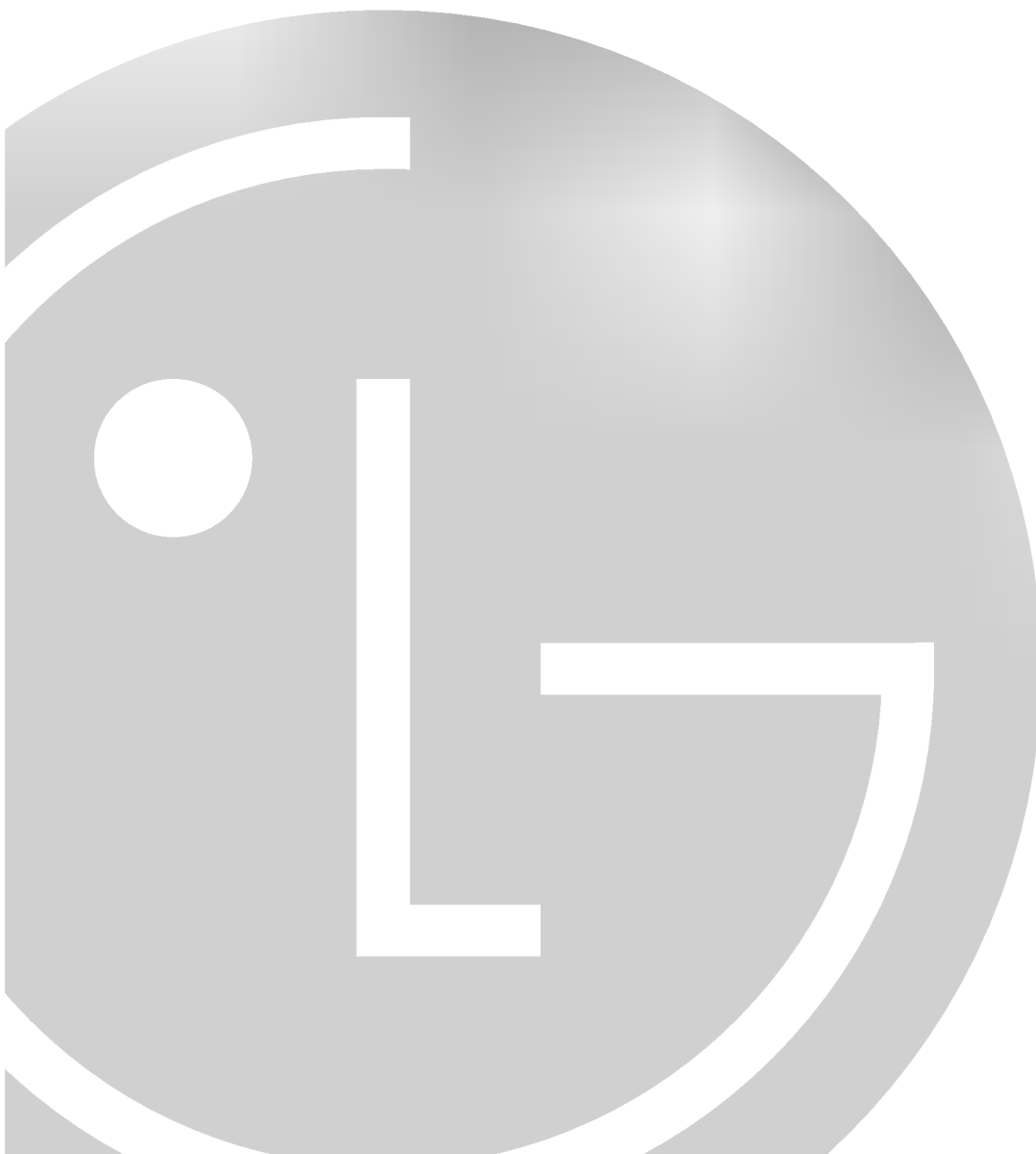

Table of Contents

Introduction	Entry	3
	Important Safety Instruction	3
	Identification of Parts	4
Installation	Where to Install	5
	Door Removal	6
	Mount the freezer and refrigerator compartment	7
	Feed Water Pipe Installation	7
	Height Adjustment	8
Operation	Getting started	9
	Designation of Functional Adjustment Board	9
	Adjusting the Temperatures and Functions	10
	Automatic Ice maker & Dispenser	11
	Home bar	14
	Shelf	15
	Egg Box	16
	Convert into a Vegetable or fresh compartment	16
Deodorizer	17	
Suggestion on food storage	Location of Foods	17
	Storing Foods	19
Care and maintenance	How to Dismantle Parts	20
	General Information	22
	Cleaning	22
	Trouble Shooting	23

Entry

The model and serial numbers are found on the inner case of the refrigerator compartment of this unit. These numbers are unique to this unit and not available to others. You should record requested information here and retain this guide as a permanent record of your purchase. Staple your receipt here.

Date of Purchase : _____

Dealer Purchased From : _____

Dealer Address : _____

Dealer Phone No. : _____

Model No. : _____

Serial No. : _____

Important Safety Instruction

Before it is used, this refrigerator must be properly installed and located in accordance with the installation instructions in this document.

Never unplug your refrigerator by pulling on the power cord. Always grip plug firmly and pull it straight out from the outlet.

When moving your appliance away from the wall, be careful not to roll over the power cord or to damage it in any way.

After your refrigerator is in operation, do not touch the cold surfaces in the freezer compartment, particularly when your hands are damp or wet. Skin could adhere to these extremely cold surfaces.

Unplug the power cord from the power outlet for cleaning or other requirements. Never touch it with wet hands because you can get an electric shock or be hurt.

Never damage, process, severely bend, pull out, or twist the power cord because damage the power cord may cause a fire or electric shock. You have doubts on whether the appliance is properly grounded.

Never place glass products in the freezer because they may be broken due to expansion when their contents are frozen.

Never allow your hands within the ice storage bin of the automatic ice maker. You could be hurt by the operation of the automatic ice maker.

Never allow anyone to climb, sit, stand or hang on the Home Bar door. These actions may damage the refrigerator and even tip it over, causing severe personal injury.

If possible, connect the refrigerator to its own individual electrical outlet to prevent it and other appliances or household lights from causing an overload that could cause a power outage.

If the supply cord is damaged, it must be replaced by a special cord or assembly from the manufacturer or its service agent.

Don't use an extension cord

Power cord replacement

Child entrapment warning

DANGER: Risk of child entrapment.

Before you throw away your old refrigerator or freezer:

Take off the doors but leave the shelves in place so that children may not easily climb inside.

The appliance is not intended for use by young children or infirm persons without supervision.

Young children should be supervised to ensure that they do not play with the appliance.

Don't store

Don't store or use gasoline or other flammable vapor and liquids in the vicinity of this or any other appliance.

Grounding (Earthing)

In the event of an electric short circuit, grounding (earthing) reduces the risk of electric shock by providing an escape wire for the electric current.

In order to prevent possible electric shock, this appliance must be grounded

Improper use of the grounding plug can result in an electric shock. Consult a qualified electrician or service person if the grounding instructions are not completely understood, or if you have doubts on whether the appliance is properly grounded.

Identification of Parts

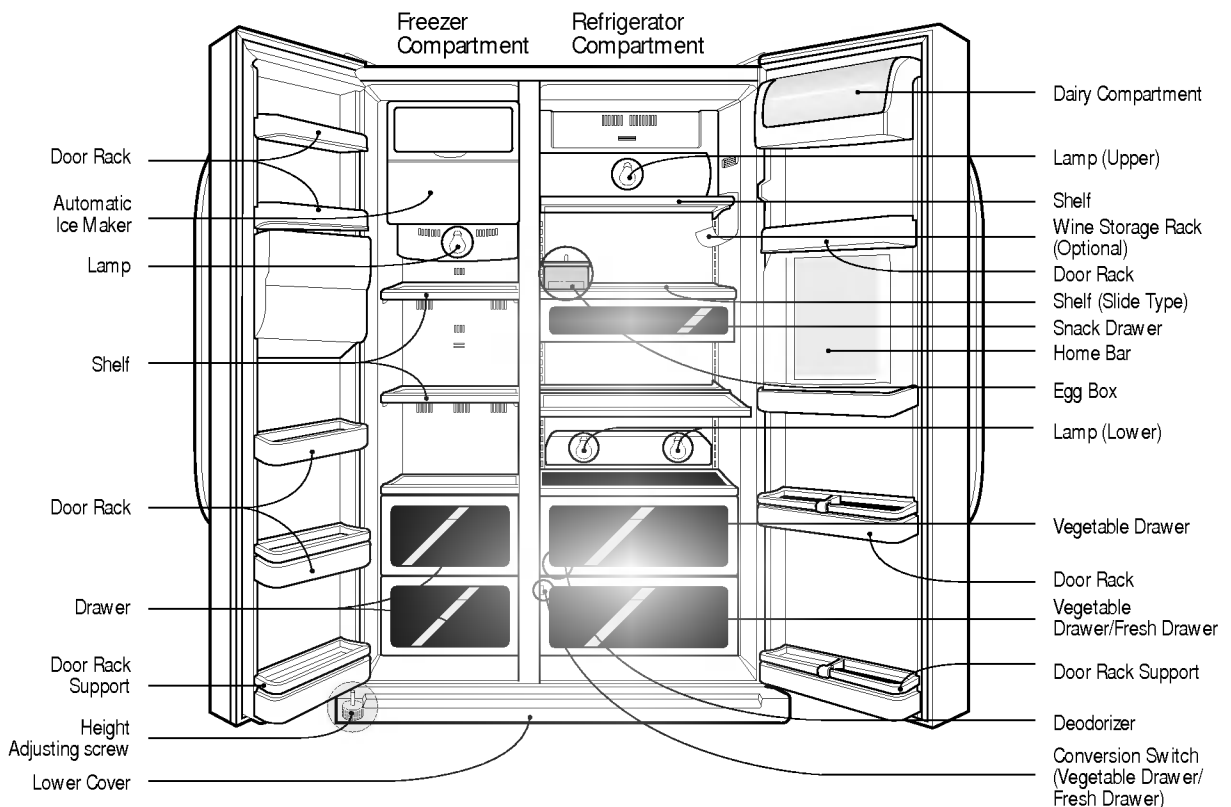

NOTE

- If you found some parts missing from your unit, they may be parts only used in other models. (i.e. the "Home Bar" is not included in all models)

Where to Install

Strong and even floor

Unstable installation may cause vibration and noise. If the floor to install the refrigerator on is not even, make the refrigerator level by rotating the height adjusting screw. Carpet or floorcloth on which a refrigerator is installed may be discolored by heat from the bottom of the refrigerator. So, it is necessary to place a thick pad below the refrigerator.

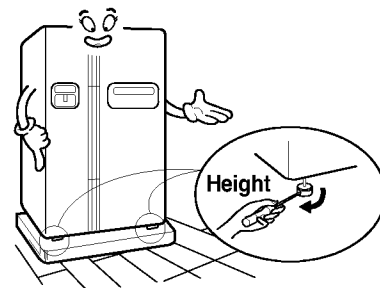

A proper distance from adjacent items

Please keep the refrigerator at a proper distance from other things. Too small a distance from adjacent items may result in lowered freezing capability and increased electricity charges consumption.

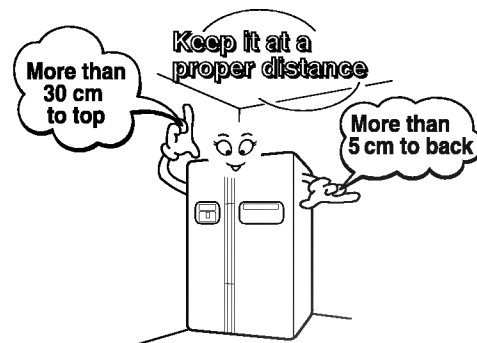

Where feed water pipe can be easily connected in a dry place

Select a place where a feed water pipe can be easily connected between the automatic ice maker and dispenser.

A wet or near-water place, refrigerator may be rusted or electricity may be leaking

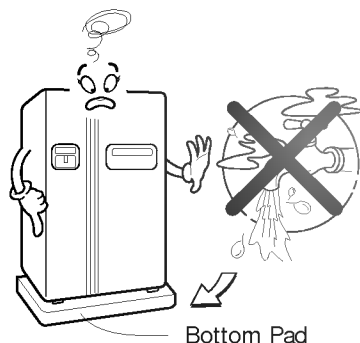

Where is free from heat or coal gas

Places where ambient temperature are high, freezing capability is deteriorated and electric charge is increased.

Coal gas and smoke may discolor the appearance of refrigerator.

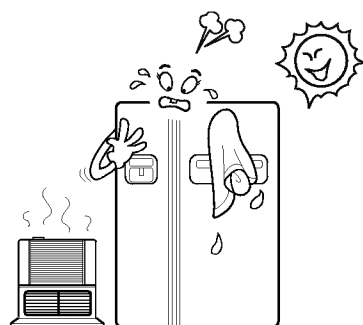

NOTE

- Install the refrigerator at a place where the ambient temperature is 5°C~43°C. Too high or low ambient temperature may cause functional troubles. Also, the tube between the dispenser and automatic ice maker may be frozen.

Door Removal

If your access door is too narrow for the refrigerator to pass the through, remove the refrigerator door and pass the refrigerator laterally.

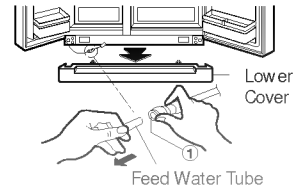

Remove the lower cover by lifting upward, and then pull up the feed water tube while pressing area ① shown in the figure to the right.

Remove lower cover and then feed water pipe

Remove the freezer compartment door

1) Separate all connection wires except for the earth line after removing the hinge cover by loosening the screws.

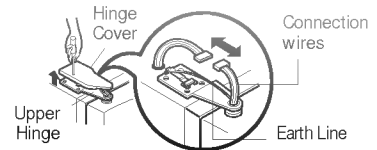

2) Remove the keeper by rotating it to counted clockwise (①) and then lifting the upper hinge up (②).

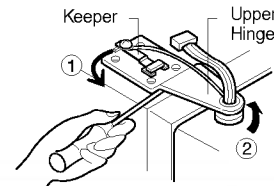

NOTE

- In removing the upper hinge, be careful so that the door does not to fall over frontward.

3) Remove the freezer compartment door by lifting it upward. This time, the door should be lifted enough for the feed water pipe tube to be completely pulled out.

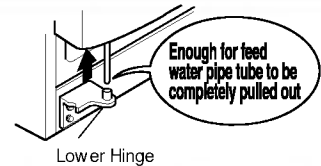

NOTE

- Move the refrigerator compartment door passing through the access door and laying it down but be careful not to damage the feed water pipe tube.

Remove the refrigerator door

1) Loosen the hinge cover screws and remove the cover. Remove all connection wires, if any, except for the earth line

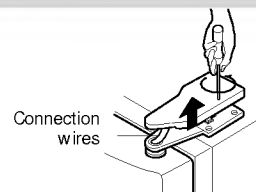

2) Remove keeper by rotating it clockwise (①) and then remove the upper hinge by lifting it up (②).

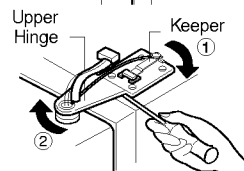

3) Remove the refrigerator compartment door by lifting it up.

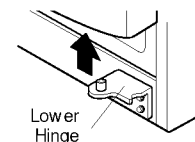

Pass the refrigerator

Pass the refrigerator laterally through the access door as shown in the right figure.

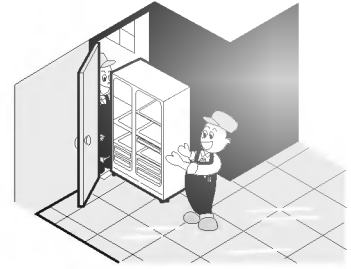

Mount the freezer and refrigerator compartment doors

Mount them in the reverse sequence of removal after they pass through the access door.

Feed water pipe Installation

Before installation

- Automatic ice maker operation needs water pressure of 147~834 kPa (1.5~8.5 kgf/cm²) (That is, an instant paper cup (180 cc) will be fully filled within 3 sec.).
- If water pressure does not reach the rating 147 kPa (1.5 kgf/cm²) or below, it is necessary to purchase a separate pressure pump for normal automatic icing and cool water feed.
- Keep the total length of the feed water pipe tube within 12 m and be careful for the tube not be bent straightly. If the tube is 12 m or longer it may cause trouble in water feed owing to the drain water pressure.
- Install the feed water pipe tube at a place free from heat.

Warning

- Connect to potable water supply only.
- Automatic Ice maker must be installed by manufacturer's services.

Height Adjustment

If the freezer compartment door is lower than the refrigerator compartment door

Make them level by inserting flat (- type) driver into the groove of the left height adjusting screw and rotating it clockwise (⌚).

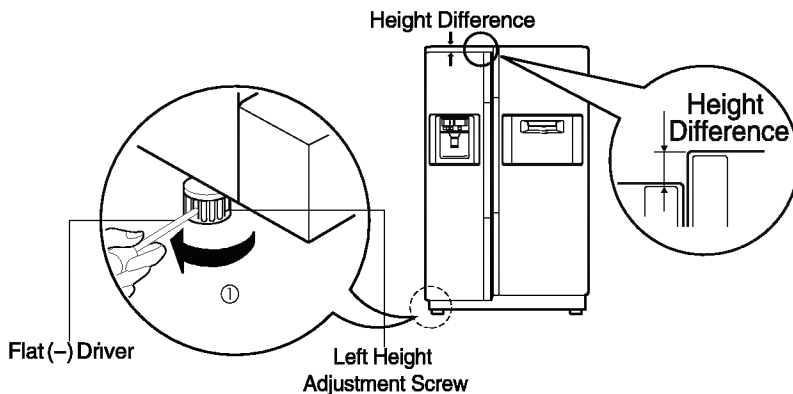

If the freezer compartment door is higher than the refrigerator compartment door

Make them level by inserting flat (- type) driver into the groove of the right height adjusting screw and rotating it clockwise (⌚).

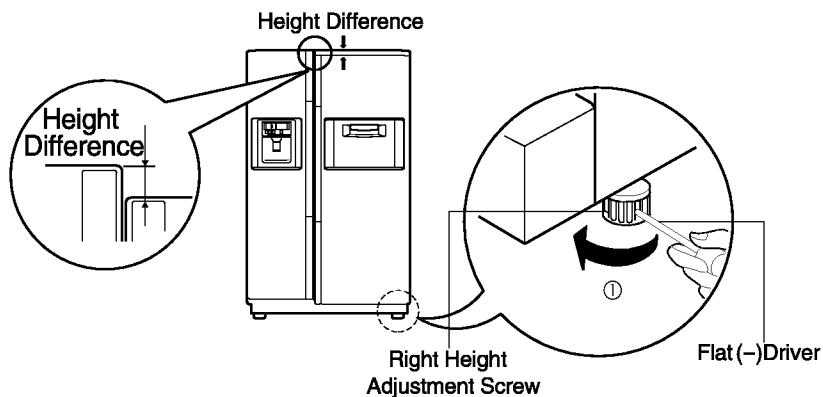

After leveling the door height

Refrigerator door will close smoothly by heightening the front side by adjusting the height adjusting screw. If the door does not close well because of bad Open/Close, performance may be affected.

Getting Started

When your refrigerator is first installed, allow it to stabilize at normal operating temperatures for 2~3 hours prior to filling it with fresh or frozen foods. If operation is interrupted, wait 5 minutes before restarting.

Designation of Functional Adjustment Board

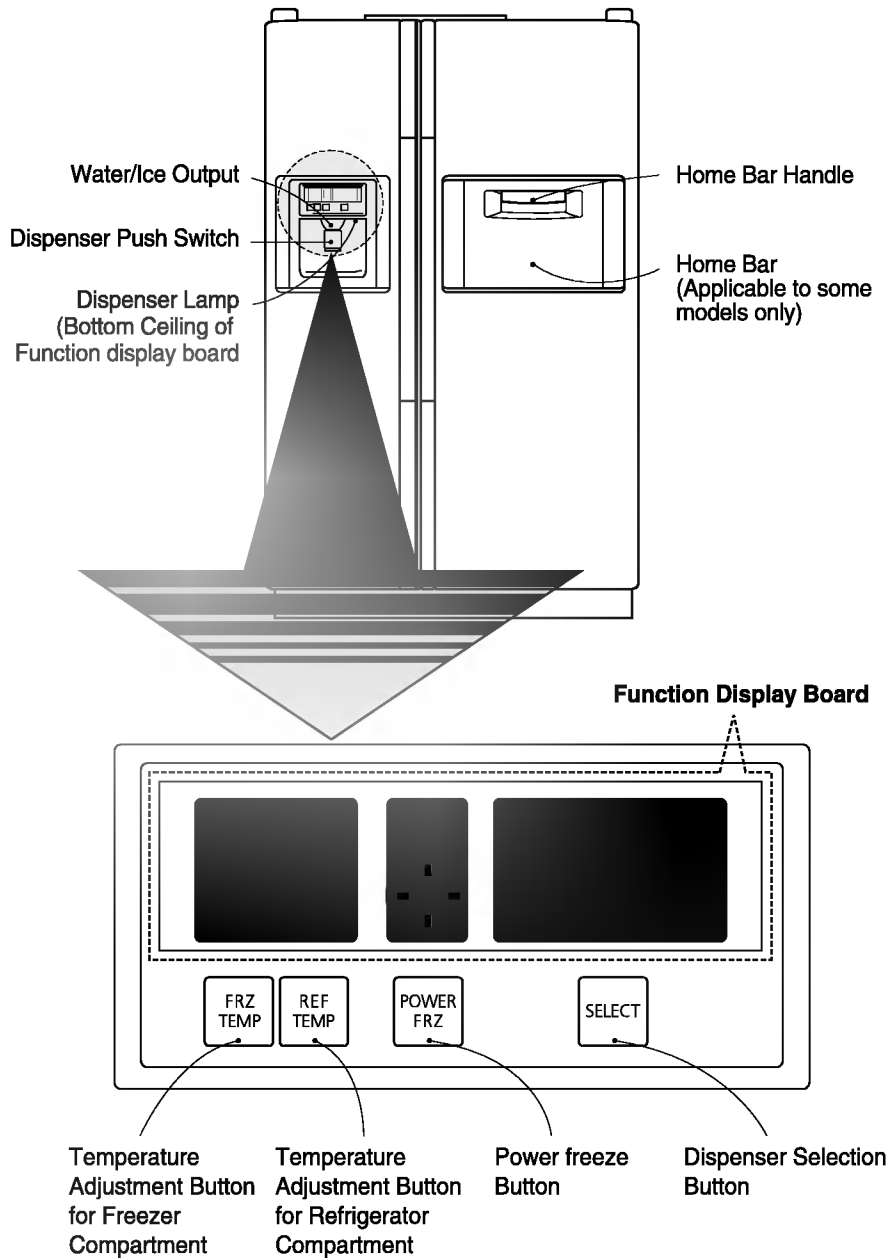

Adjust the Temperature and Functions

How to adjust the temperature in the freezer compartment

This lamp indicates the temperature status of the freezer compartment.

- At first powering or after a power failure, 2(Proper) will be lit.
- Pressing  button will move the temperature setting through 2(Proper) → (Proper Strong) → 3(Strong) → (Strongest) → 1(Weak) → (Proper Weak) in sequence.
- Generally, 2(Proper) is good for food storing. Select an appropriate one among 1(Weak), (Proper Weak) or (Proper Strong), 3(Strong), and (Strongest) according to the storing amount and using frequency.



Low Temperature
(When frozen foods are thawing)

High Temperature
(When foods are severely thawing)



How to adjust the temperature in refrigerator compartment

This lamp indicates the temperature status of the refrigerator compartment

- At first powering or after a power failure, 2(Proper) will be lit.
- Pressing  button will move the temperature setting through 2(Proper) → (Proper Strong) → 3(Strong) → (Strongest) → 1(Weak) → (Proper Weak) in sequence.
- Generally, 2(Proper) is good for food storing.



Low Temperature
(To make food cooler)

High Temperature
(When foods are frozen)



Select an appropriate one among 1(Weak), (Proper Weak) or (Proper Strong), 3(Strong) and (Strongest) according to the storing amount and using frequency.

NOTE

- Set the temperature adjusting board to a desirous compartment as inner temperature may be varied according to the using environment. Inner temperature is increasingly lowered getting to 3.
- Detach the protective tape on the front surface of function display board to make the surface and light more clear.

Power freeze



This lamp indicates that the power freeze function is in operation. The power freeze function is used to freeze food or make ice faster in the freezer compartment.

- Pressing  button operates power freeze function, with the lamp ON.
- One pressing of the button switches the status from setting to release, or reversely.
- Power freeze will be automatically released, though no release action is taken, after a certain time passes.



Dispenser use selection

This lamp indicates the selection between water and ice.

- At the first powering or after a power failure,  will be lit.
- Crushed ice, water, or cubed ice can be selected with the  button.



Door open alarm

An alarm will ring 3 times if the refrigerator door is left opened for more than 1 minute. This alarm will ring at 30 sec. and stop when the door is opened. 'Door Open Alarm' function makes alarm sound only, having no separate indicating function. If the alarm sound does not stop even after the freezer and refrigerator compartment doors are closed, contact the service center.

Self-diagnosis (fault detection) function

The Self-diagnosis function operates when something is wrong with the unit. When an error occurs in the unit, pressing any of the buttons will have no effect. Immediately contact the service center without turning the power OFF. If the power is OFF, it takes much longer for the service engineer to find the cause of the problem.

How ice/cold water is supplied

Water is cooled while stored in the water tank in the refrigerator compartment, and then sent to the dispenser. Ice is made in the automatic ice maker and sent to the dispenser divided into crushed or cubed form ice.

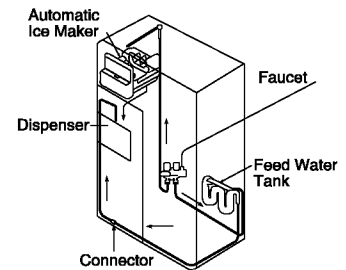

NOTE

- It is normal that the water is not very cold enough at first. If you want colder water, add ice into the glass.

How to use dispenser

- Select one among crushed ice, water, and cubed ice and slightly press the push switch with a glass or other container.

Crushed Ice

Light the crushed ice indicating lamp by pressing the selection button.

- Crushed ice will be dispensed by pressing the push switch with a glass.

Water

Light the water indicating lamp by pressing the selection button.

- Water will be dispensed by pressing the push switch with a glass.

Cubed Ice

Light the cubed ice indicating lamp by pressing the selection button.

- Cubed ice will be dispensed by pressing the push switch with a glass.

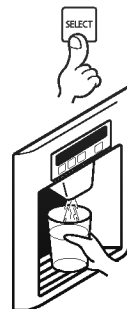
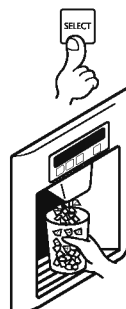

NOTE

- Crushed ice will be automatically selected after a power failure or when the power plug is connected again.
- Place glasses or other containers near the ice outlet otherwise ice is likely to be dropped on the floor.
- A snap sound will be heard in 5 seconds after ice is fully dispensed. This sound is made when the ice outlet is closed.
- Please leave your glass near the ice outlet for 2~3 seconds after releasing your glass from pressing the push switch to allow any left over water or ice to be dispensed.
- Please wipe away water dropped below the dispenser by removing the water collector cover.
- If cubed ice is selected following crushed ice, there may still be some left over crushed ice that is dispensed.

Automatic ice maker

- The automatic ice maker can automatically make 8 pieces of ice cube at a time, 80 pieces a day. But these quantities may be varied according to various conditions including how many times the refrigerator door opens and closes.
- Ice making stops when the ice storage bin is full.

NOTE

- It is normal that a noise is produced when ice made is dropped into the ice storage bin.

When ice maker does not operate smoothly

Ice is lumped together

- When ice is lumped together, take the ice lumps out of the ice storage bin, break them into small pieces, and then place them into the ice storage bin again.
- When the ice maker produces too small or lumped ice, the amount of water supplied to the ice maker need to adjusted. Contact the service center.
- ※ If ice is not used frequently, it may lump together.

Power failure

- Ice meet drop into the freezer compartment. Take the ice storage bin out and discard all the ice then dry it and place it back. After the machine is powered again, crushed ice will be automatically selected.

The unit is newly installed

- It takes about 12 hours for a newly installed refrigerator to make ice in the freezer compartment.

Cautions

Throw away the ice (about 20 pieces) and water (about 7 glasses) first made after refrigerator installation.

The first ice and water may include particles or odor from the feed water pipe or feed water box. This is necessary in case that the refrigerator has not been used for a long time.

Keep children away from the dispenser.

Children may push switch incorrectly bad or damage lamps.

Be careful that food is not block the ice passage.

If foods are placed at the entrance of ice passage, ice may not be dispensed. The ice passage may also be covered with ice powder if splinter ice is used only. This time, remove the ice powder accumulated.

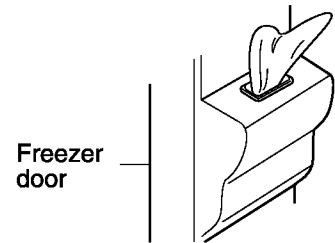
**Never store beverage cans or other foods in ice storage bin for the purpose of rapid cooling.**

Such actions may damage the automatic ice maker.

Never use thin crystal glass or crockery to collect ice.

Such glasses or containers may be broken.

Put ice first into a glass before filling water or other beverages.

Water may be splashed if ice is added to existing liquid in a glass.

Never touch a hand or other tools on ice outlet.

Touch may cause a part breakage or hand injury.

Never remove the ice maker cover.**Sometimes level the surface so that the ice storage bin is fully filled with ice.**

Ice is piled up just near the ice maker. So, such status may be considered, by the ice maker, that the ice storage bin is fully filled and ice making operation may stop.

If discolored ice is dispensed, immediately contact Service Center, stopping use.**Never use too narrow or deep glass.**

Ice may be jammed in ice passage and, thus, the refrigerator may be failed.

Keep the glass at a proper distance from ice outlet.

A glass too close to the outlet may hinder ice from coming out.

Home Bar (In select Models Only)

How to use

Gently pull the handle of the home bar to open it.

- You can access the home bar without opening the refrigerator door, thus saving electricity.
- The Inner lamp is lit in the refrigerator compartment when the home bar door opens. So it is easy to see item in the compartment.

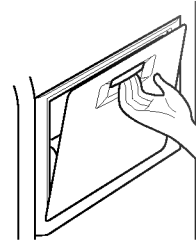

Store frequently accessed items, such as beverages in the home bar.

- Home bar is kept at the right temperature thanks to a temperature sensor only for the home bar.

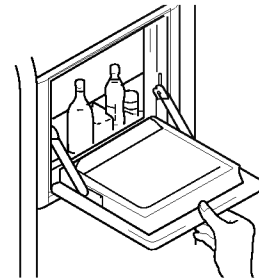

Use the home bar door as a stand

- You can use the home bar door as a stand to pour beverages and such but never use the home bar door as a chopping board and take care not to damage it with sharp objects.
- Never rest your arms or press down on it.

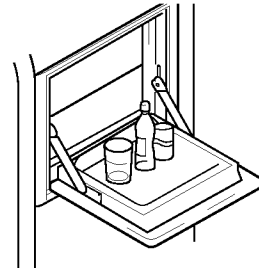

Never take out the inner home bar cover

- The Home bar will not function properly without the cover.

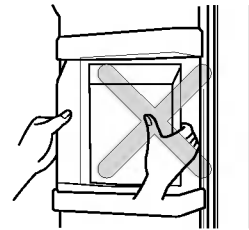

Never place heavy matters on the home bar door or allow children to hang on it.

- Not only the home bar door may be damaged, but also children may get hurt.

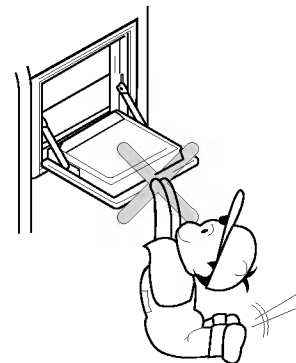

Shelf

Slide type tempered glass shelf
(In select models only)

Slide type shelf allows you to place or take food out or put it in more conveniently.

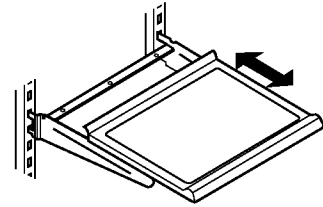

Attachable wine corner (In select models only)

Bottles can be stored laterally with this wine corner. This can be attached to any shelf.

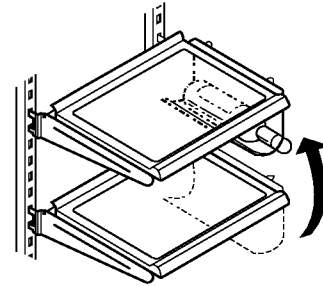

Wine holder adjustment :

Wine holder can be separated by pulling it straight out and installed by placing it at the end of the shelf you want and pushing it inward.

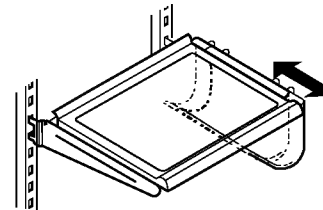

Shelf height adjustment

The Refrigerator compartment shelf is movable so that you can place it at a proper height according to the space you need for different food items..

How to separate a shelf :

At delivery, shelves are fixed with keepers so that they cannot be moved during distribution. So, remove keepers first, lift the shelf up (①), and then separate it pushing it down (②).

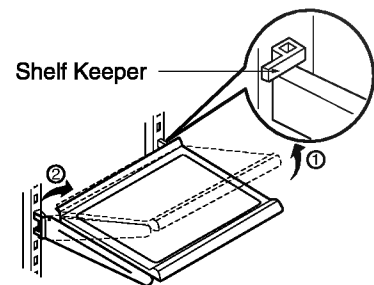

How to install a shelf :

Position the shelf at the desired height and hang its links on the grooves. This time, lower the front side of the shelf and hang it on the grooves.

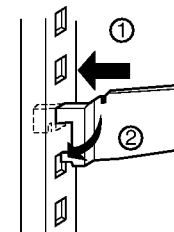

NOTE

- Make the shelf horizontal. Otherwise it may fall off.

Egg Box

You can move the egg box to a place you want and select another form of box according to the amount of eggs.

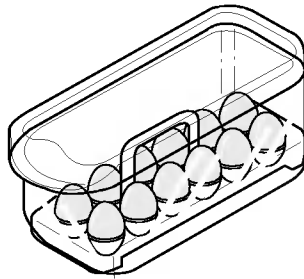

[Normal]

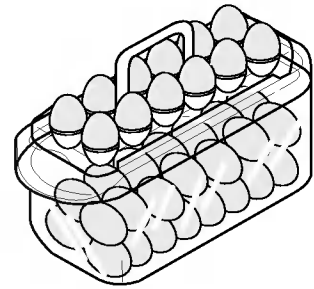

[For Many Eggs]

NOTE

- Never use the egg box as an ice storage bin. It can break.
- Never store the egg box in the freezer compartment or fresh compartment.

Convert into a Vegetable or Fresh compartment

- The Bottom drawer in the refrigerator can be converted into a vegetable or fresh compartment

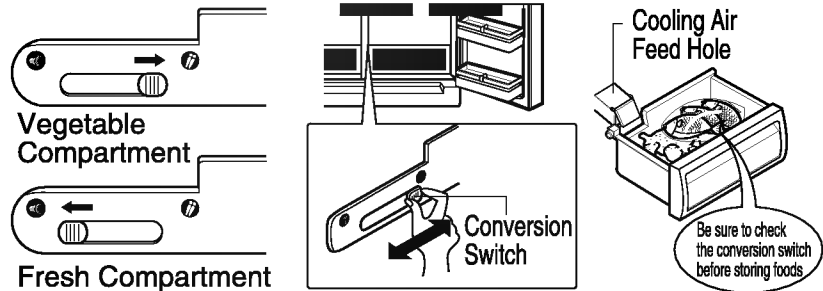

The Fresh compartment maintains the temperature at a lower point than the refrigerator compartment so that meat or fish can be stored fresh longer.

NOTE

- Vegetables or fruits are frozen if the conversion switch is set to fresh compartment. So, be sure to check it before storing foods.
- If possible, do not place food around the cool air feed hole, which is connected to the conversion switch, because it is difficult to use the conversion switch.

Deodorizer

This system efficiently absorbs strong odors by using the optical catalyst. This system does not have any effect on stored food.

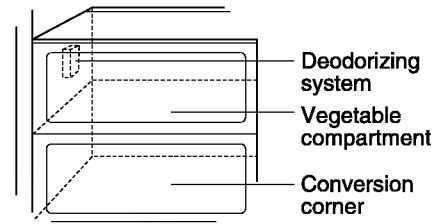

How to use the deodorizing system

- Since it is already installed onto the cool air intake duct from the refrigerator compartment, you need no separate installation.
- Please use closed containers to store food with pungent odors. Otherwise, this odor can be absorbed by other food in the compartment.

Location of Food

(Refer to 4pages, Identification of Parts)

Automatic ice maker	Automatically made ice is stored.
Wine rack	Store wine.
Snack Drawer	Store small foods such as bread, snacks, etc.
Freezer compartment shelf	Store various frozen foods such as meat, fish, ice cream, frozen snacks, etc. <ul style="list-style-type: none">▪ Store small packaged frozen food.▪ Temperature is likely to increase as door opens. So, do not store long-term food such as ice cream.
Freezer compartment door rack	<ul style="list-style-type: none">▪ Store meat, fish, chicken, etc. after wrapping them with aluminum.
Freezer compartment drawer	
Dairy compartment	Store dairy products such as butter, cheese, etc.
Egg box	Place this egg box in the proper location.
Home bar	Store frequently accessed foods such as beverage, etc..
Refrigerator compartment shelf	Store side dishes or other foods at a proper distance from each other for effective cooling.
Refrigerator compartment door rack	Store small packaged food or beverages such as milk, juice, beer, etc..
Vegetable compartment	Store vegetables or fruits.
Vegetable compartment/fresh compartment conversion corner	Store vegetable, fruits, meat to thaw, fish, etc. setting the conversion switch as necessary. Be sure to check the conversion switch setting before storing foods.

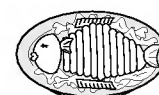
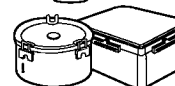
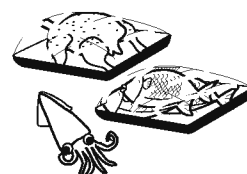
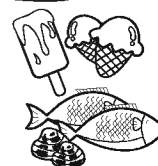
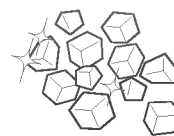

Storing Foods

- Store fresh food in the refrigerator compartment. How food is frozen and thawed is an important factor in maintaining its freshness and flavor.
- Do not store food which goes bad easily at low temperatures, such as bananas, and melons.
- Allow hot food to cool prior to storing, placing hot food in the refrigerator could spoil other food, and lead to higher energy consumption.
- When storing the food, cover it with vinyl wrap or store in a container with a lid. This prevents moisture from evaporating, and helps food to keep its taste and nutrients.
- Please keep a distance at least 15 mm from the air vents to food.
- Do not open the door frequently. Opening the door lets warm air enter the refrigerator, and cause temperatures to rise.
- Never keep too much food in door rack because they may push against by inner racks so that the door cannot be fully closed.

Freezer compartment

- Do not store bottles in the freezer compartment - they may break when frozen.
- Do not refreeze food that has been thawed. This causes loss of taste and nutrient.
- When storing frozen food like ice cream for a long period, place it on the freezer shelf, not in the door rack.

Refrigerator compartment

- Avoid placing moist food in top refrigerator shelves, it could freeze from direct contact with chilled air.
- Always clean food prior to refrigeration. Vegetables and fruits should be washed and wiped, and packed food should be wiped, to prevent adjacent food from spoiling.
- When storing eggs in their storage rack or box, ensure that they are fresh, and always store them in an upright position, which keeps them fresh longer.

NOTE

- If you keep the refrigerator in a hot and humid place, and frequently open the door or put a lot of vegetables in it, moisture may form in it which has no effect on its performance. Just wipe the moisture with a cloth free.

How to Dismantle Parts

NOTE

- Dismantling is done in the reverse sequence of assembly.
Be sure to unplug the power plug before dismantling and assembly.
Never apply severe force to dismantle parts. Parts may be damaged.

Freezer compartment lamp

Separate the lamp by pulling it out (②) while slightly lifting the lamp cover (①).
Turn the bulb counterclockwise. Max. 240 V . 60 W bulb for refrigerator is used and can be purchased at a service center.

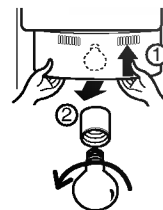

Dispenser lamp

Remove the cover by inserting a flat (- type) driver into the front groove and pulling it out, and then remove the lamp. Max. 240 V 15 W bulb for refrigerator is used and can be purchased at a service center.

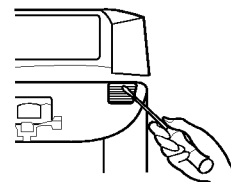

Freezer compartment shelf

Lift the front side (①) and pull it out (②).

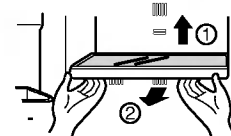

Door rack and support

Lift the door rack holding both sides (①) and pull it out to (②) direction.

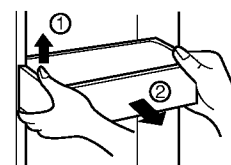

Ice storage bin

Hold the ice storage bin as shown in the right figure and pull it out (②) while slightly lifting it (①).

- It is recommended not to dismantle the ice storage bin unless it is necessary.
- Be sure to use both hands when removing the ice storage bin, not to drop it on the floor.
- If the ice storage bin does not fit well, slightly rotate the rotating device.

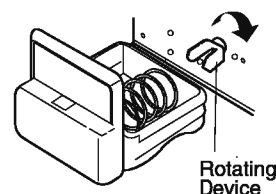
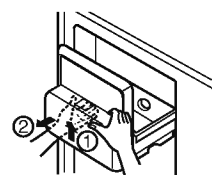

Rotating Device

After dispenser is used

Water collector has no self-drainage function. So it should be cleaned regularly. Remove the cover by pressing the left side of water collector cover and dry it with a cloth. Press the point marked as shown in the figure to remove the water collector cover.

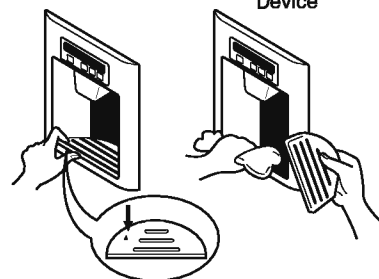

Upper lamp in refrigerator compartment

To remove the lamp cover, pull the lamp cover forwards while pressing the bottom side of the lamp cover upwards. Turn the bulb counterclockwise.

Max. 240 V 60 W bulb for refrigerator is used and can be purchased at a service center.

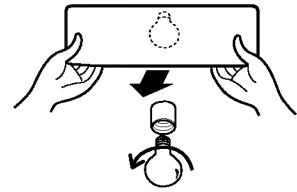

Lower lamp in refrigerator compartment

Separate the lamp cover by holding both lower sides of it and pulling it forwards. Turn the bulb counterclockwise. Max. 240 V 30 W bulb for refrigerator is used and can be purchased at a service center.

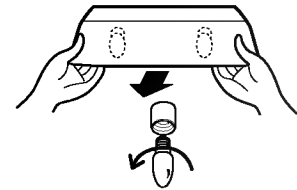

Home bar

- Separate the upper rack of the home bar and then pull out the home bar cover (①).
- The Home bar corner can be removed by pulling it upwards.

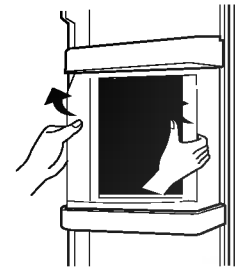

NOTE

- Be sure to remove parts on the refrigerator door to remove the vegetable compartment, snack drawer and home bar cover.

Vegetable compartment cover

- Pull out the vegetable compartment cover (②) with its backside lifted up (①), and the cover can be removed.
- To install the cover, push it fully until it touches the back wall.

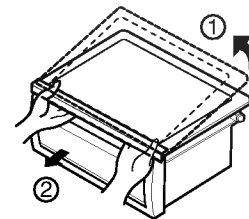

General Information

Vacation time	<p>During average length vacations, you will probably find it best to leave the refrigerator in operation. Place freezable items in freezer for longer storage.</p> <p>When you plan not to operate, keep it running remove all food, disconnect the power cord, clean the interior thoroughly, and leave each door OPEN to prevent odor formation.</p>
Power failure	<p>Most power failures are corrected in an hour or two will not affect your refrigerator temperatures.</p> <p>However, you should minimize the number of door openings while the power is off.</p> <p>During power failures of longer duration, place a block of dry ice on top of your frozen packages.</p>
If you move	<p>Remove or securely fasten down all loose items inside the refrigerator.</p> <p>To avoid damaging the height adjusting screws, turn them all the way into the base.</p>
Anti condensation pipe	<p>The outside wall of the refrigerator cabinet may sometimes get warm, especially just after installation.</p> <p>Don't be alarmed. This is due to the anti-condensation pipe, which pumps hot air refrigerator to prevent "sweating" on the outer cabinet wall.</p>

Cleaning

It is important that your refrigerator be kept clean to prevent undesirable odors. Spilled food should be wiped up immediately, since it may acidify and stain plastic surfaces if left uncleaned.

Exterior	<p>Use a lukewarm solution of mild soap or detergent to clean the durable finish of your refrigerator.</p> <p>Wipe with a clean damp cloth and then dry.</p>
Interior	<p>Regular cleaning is recommended. Wash all compartments with a baking soda solution or a mild detergent and warm water. Rinse and dry.</p>
After cleaning	<p>Please verify that the power cord is not damaged, power outlet is not overheated, or power plug is inserted well into the power outlet.</p>
Warning	<p>Always remove power cord from the wall outlet prior to cleaning in the vicinity of electrical parts (lamps, switches, controls, etc.).</p> <p>Wipe up excess moisture with a sponge or cloth to prevent water or liquid from getting into any electrical part and causing an electric shock.</p> <p>Never use metallic scouring pads, brushes, coarse abrasive cleaners, strong alkaline solutions, flammable or toxic cleaning liquids on any surface.</p> <p>Do not touch frozen surfaces with wet or damp hands, because damp object will stick or adhere to extremely cold surfaces.</p>

Trouble Shooting

Before calling for service, review this list. It may save you both time and expense. This list includes common occurrences that are not the result of defective workmanship or materials in this appliance.

Normal Operations Refrigerator

Refrigerator compressor does not run.	Refrigerator control is off.	Set refrigerator control.
	Refrigerator is in defrost cycle.	This is normal for a fully automatic defrosting refrigerator. The defrost cycle occurs periodically.
	Plug at wall outlet is disconnected.	Make sure plug is tightly pushed into outlet.
	Power outage. Check house lights.	Call local electric company.
Refrigerator runs too much or too long	Refrigerator is larger than the previous one you owned.	This is normal. Larger, more efficient units run longer.
	Room or outside weather is hot.	It is normal for the refrigerator to work longer under these conditions.
	Refrigerator has recently been disconnected for a period of time.	It takes a few hours for the refrigerator to come down to room temperature completely.
	Automatic ice maker is operating.	Operation of the ice maker causes the refrigerator to run slightly longer.
	Large amounts of warm or hot food may have been stored recently.	Warm food will cause the refrigerator to run longer until the desired temperature is reached.
	Doors are opened too frequently or too long.	Warm air entering the refrigerator causes it to run more. Open the door less often.
	Refrigerator or freezer door may be slightly open.	Make sure the refrigerator is level. Keep food and containers from blocking the door. See problem section. OPENING/CLOSING of Doors.
	Refrigerator control is set too cold.	Set the refrigerator control to a warmer setting until the refrigerator temperature is satisfactory.
	Refrigerator or freezer gasket is dirty, worn, cracked, or poorly fitted.	Clean or change gasket. Leaks in the door seal will cause the refrigerator to run longer in order to maintain desired temperatures.

Refrigerator compressor does not run.	Thermostat is keeping the refrigerator at a constant temperature.	This is normal. The Refrigerator goes on and off to keep the temperature constant.
Temperatures are too cold		
Temperature in the freezer is too cold but the Refrigerator Temperature is Satisfactory.	Freezer control is set too cold	Set the freezer control to a warmer setting until the freezer temperature is satisfactory.
Temperature in the refrigerator is too cold and the freezer temperature is satisfactory.	Refrigerator control is set too cold.	Set the refrigerator control to a warmer setting
Food stored in drawers freezes.	Refrigerator control is set too cold.	See above solution.
Meat stored in fresh meat drawer freezes.	Meat should be stored at a temperature just below the freezing point of water (32°F, 0°C) for maximum fresh storage time.	It is normal for ice crystals to form due to the moisture content of meat.
Temperatures are too warm		
Temperatures in the refrigerator or freezer are too warm.	Freezer control is set too warm.	Set the freezer or refrigerator control to a colder setting until the freezer or refrigerator temperature is satisfactory.
	Refrigerator control is set too warm. Refrigerator control has some effect on freezer temperature.	Set the freezer or refrigerator control to a colder setting until the freezer or refrigerator temperature is satisfactory.
	Doors are opened too frequently or too long.	Warm air enters the refrigerator/ freezer whenever the door is opened. Open the door less often.
	Door is slightly open.	Close the door completely.
	Large amounts of warm or hot food may have been stored recently.	Wait until the refrigerator or freezer has had a chance to reach its selected temperature.
	Refrigerator has recently been disconnected for a period of time.	A refrigerator requires some hours to cool down completely.
Temperature in the refrigerator is too warm but the freezer temperature is satisfactory.	Refrigerator control is set too warm.	Set the refrigerator control to a colder setting.

Sound and Noise

Louder sound levels when Refrigerator is on.	Today's refrigerators have increased storage capacity and maintain more even temperatures.	It is normal for sound levels to be higher.
Louder sound levels when compressor comes on.	Refrigerator operates at higher pressures during the start of the ON cycle.	This is normal. The sound will level off as the refrigerator continues to run.
Vibrating or rattling noise.	Floor is uneven or weak. Refrigerator rocks on the floor when it is moved slightly.	Be sure floor is level and solid and can adequately support refrigerator.
	Items placed on the top of the refrigerator are vibrating.	Remove items.
	Dishes are vibrating on the shelves in the refrigerator.	It is normal for dishes to vibrate slightly. Move dishes slightly. Make sure refrigerator is level and firmly set on floor.
	Refrigerator is touching wall or cabinets.	Move refrigerator so that it does not touch the wall or refrigerator.

Water/Moisture /Ice Inside Refrigerator

Moisture collects on the inside walls of the refrigerator.	The weather is hot and humid which increases the rate of frost buildup and internal sweating.	This is normal.
	Door is slightly open.	See problem section Opening/Closing of doors.
	Door is opened too often or too long.	Open the door less often.

Water/Moisture/Ice Outside Refrigerator

Moisture forms on the outside of the refrigerator or between doors.	Weather is humid.	This is normal in humid weather. When humidity is lower, the moisture should disappear.
	Door is slightly open, causing cold air from the inside the refrigerator to meet warm air from the outside.	This time, close the door completely.

Odors in Refrigerator		
	Interior needs to be cleaned.	Clean interior with sponge,warm water and baking soda.
	Food with strong odor is in the refrigerator.	Cover food completely.
	Some containers and wrapping materials produce odors.	Use a different container or brand of wrapping materials.
Opening/Closing of Doors/Drawers		
Door(s) will not close.	Food package is keeping door open.	Move packages that keep door from closing.
Door(s) will not close.	Door was closed too hard, causing other door to open slightly.	Close both doors gently.
	Refrigerator is not level. It rocks on the floor when it is moved slightly.	Adjust the height adjusting screw.
	Floor is uneven or weak. Refrigerator rocks on the floor when it is moved slightly.	Be sure floor is level and can adequately support refrigerator. Contact carpenter to correct sagging or sloping floor.
	Refrigerator is touching wall or cabinets.	Move refrigerator..
Drawers are difficult to move.	Food is touching shelf on top of the drawer	Keep less food in drawer.
	Track that drawer slides on is dirty.	Clean drawer and track.
Dispenser		
Dispenser will not dispense ice	Ice storage bin is empty.	When the first supply of ice is dropped into the bin, the dispenser should operate.
	Freezer temperature is set too warm.	Turn the freezer control to a higher setting so that ice cubes will be made. When the first supply of ice is made, the dispenser should operate.
	Household water line valve is not open.	Open household water line valve and allow sufficient time for ice to be made. When ice is made, dispenser should operate.
	Refrigerator or freezer door is not closed.	Be sure both doors are closed.

Dispenser will not dispense ice.	Ice has melted and frozen around auger due to infrequent use, temperature fluctuations and/or power outages.	Remove ice storage bin, and thaw and the contents. Clean bin, wipe dry and replace in proper position. When new ice is made, dispenser should operate.
Ice dispenser is jammed.	Ice cubes are jammed between the ice maker arm and back of the bin.	Remove the ice cubes that are jamming the dispenser.
	Ice cubes are frozen together.	Use the dispenser often so that cubes do not freeze together.
	Ice cubes that have been purchased or made in some other way have been used in the dispenser.	Only the ice cubes made by the ice maker should be used with the dispenser.
Dispenser will not dispense water.	Household water line valve is not open. See problem "Ice maker is not making any ice."	Open household water line valve.
	Refrigerator or freezer door is not closed.	Be sure both doors are closed.
Water has an odd taste and/or odor.	Water has been in the tank for too long.	Draw and discard 7 glasses of water to freshen the supply. Draw and discard an additional 7 glasses to completely rinse out tank.
	Unit not properly connected to cold water line.	Connect unit to cold water line which supplies water to kitchen faucet.
Sound of ice dropping	This sound is normally made when automatically made ice is dropped into ice storage bin. Volume may vary according to refrigerator's location.	
Sound of water supply	This sound is normally made when ice maker is supplied with water after dropping the automatically made ice.	
Other	Please thoroughly read 'Automatic ice maker and Dispenser' in this manual.	



LG Electronics Inc.

LG Twin Tower, 20, Yoido-Dong,
Youngdungpo-Gu, Seoul, 150-721, Korea.
<http://www.lge.co.kr>