



Room Air Conditioner OWNER'S MANUAL

WINDOW TYPE ROOM AIR CONDITIONER

- Please read carefully and thoroughly this manual before operating this unit.
- Contact the authorized SVC man for repair or maintenance of this unit.
- Contact the installer for installation of this unit.
- The appliance is not intended for use by young children or infirm persons without supervision.
- Young children should be supervised to ensure that they do not play with the appliance.

**MODELS : LWC1260ACG/ LWC1260BCG
LWC1260PCG
LWC0960AHG/ LWC0960PHG
LWC1260AHG/ LWC1260PHG**

ENGLISH	P.1 - P.12
ITALIANO.....	P.13 - P.24
FRANÇAIS.....	P.25 - P.36
FRANÇAI.....	P.37 - P.48
DEUTSCH.....	P.49 - P.60

Prior to installation, this air-conditioning unit must be submitted for approval by the utility service which provides electricity (EN 60555-3 Norm).

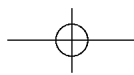

TABLE OF CONTENTS

SAFETY PRECAUTIONS.....2

FEATURES.....5

OPERATING.....6

 FUNCTION.....6~8

 HOW TO INSERT BATTERIES.....8

 VENTILATION.....9

 TO CONTROL AIR DIRECTION.....9

 AIR FILTER CLEANING.....10

 HOW TO COMBINE FRONT GRILLE WITH CABINET.....10

INSTALLATION.....11

BEFORE REQUESTING SERVICE.....12

SAFETY PRECAUTIONS

Before operating, please read the following "Safety precautions" carefully.

To prevent injury to the user or other people and properties damage, the following instructions must be followed.

■ Incorrect operation due to ignoring of instruction will cause harm or damage, the seriousness is classified by the following indications.

	Warning : This indication shows the possibility of causing death or serious injury.
	Caution : This indication shows the possibility of causing injury or damage to properties only.

■ The items to be followed are classified by the following symbols.

	Symbol(with white background) denotes item that is PROHIBITED from doing.
	Symbol(with white background) denotes item that is COMPULSORY to be carried out.

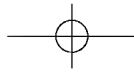

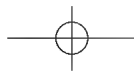

Operation precautions

WARNING

Plug in the power plug properly.

- Otherwise, it will cause electrical shock or fire due to heat generation or electrical shock.

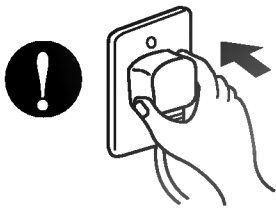

Do not operate or stop the unit by inserting or pulling out the power plug.

- It will cause electrical shock or fire due to heat generation.

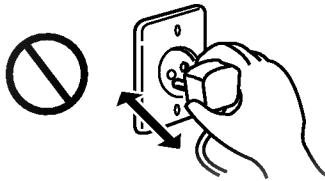

Do not damage or use an unspecified power cord.

- It will cause electrical shock or fire.
- If the supply cord is damaged, it must be replaced by a special cord or assembly available from the manufacturer or its service agent.



Do not modify power cord length or to share the single outlet with other appliances.

- It will cause electrical shock or fire due to heat generation.

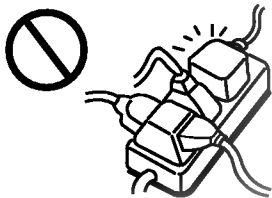

Do not operate with wet hand.

- It may cause electrical shock.



Do not expose the skin to cool air directly for long time.

- This could damage your health.

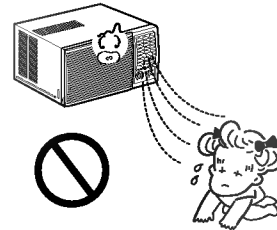

When an abnormality (smell of burning, etc) occurs, stop the air conditioner, and disconnect the power plug or turn off the breaker.

- If the unit continues to be operated in an abnormal condition, it may cause a fire, trouble, etc. In this case, consult your dealer.

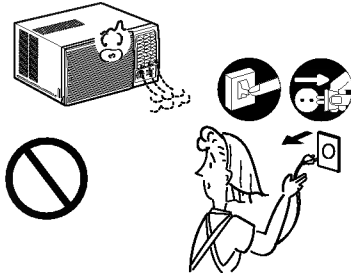

Repair or relocation should not be done by the customer.

- If this is done in correctly, it may cause a fire, electric shock, injury by dropping of the unit, water leakage, etc. Consult your dealer.

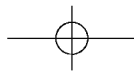
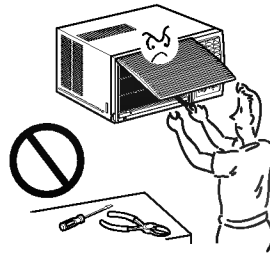

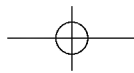

CAUTION

When the air filter is to be removed, do not touch the metalparts of the unit.

- It may cause an injury.

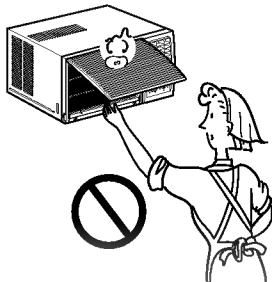

Do not clean the air conditioner with water.

- Water may enter the unit and degrade the insulation. It may cause an electric shock.

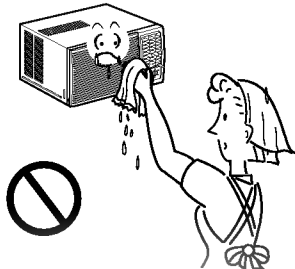

Ventilate well when used together with a stove, etc.

- An oxygen shortage may occur.

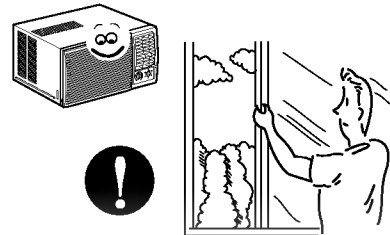

When the unit is to be cleaned, switch off, and turn off the breaker.

- Since the fan rotates at high speed during operation, it may cause an injury.

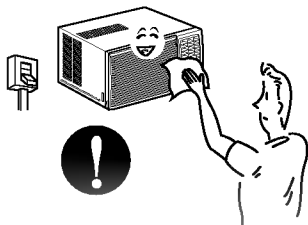

Do not put a pet or house plant where will be exposed to direct air flow.

- This could injure the pet or plant.

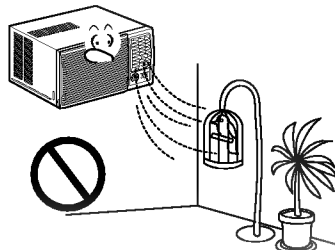

Do not use for special purposes.

- Do not use this air conditioner to preserve precision devices, food, animal, plants and art objects. It may cause deterioration of quality, etc.

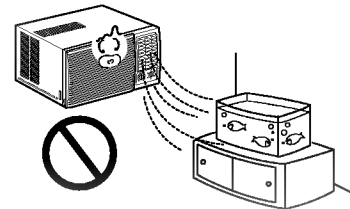

Do not operate switches with wet hands.

- It may cause an electric shock.

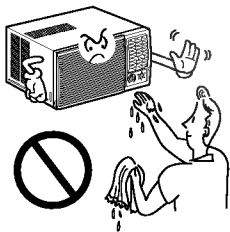

Do not apply an insecticide or flammable spray.

- It may cause a fire or deformation of the cabinet.

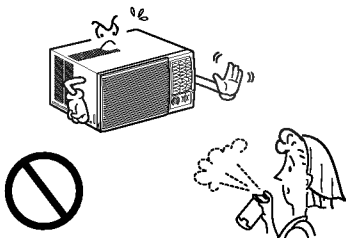

Do not put a stove, etc. where is exposed to direct air flow.

- It may cause imperfect combustion.

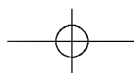
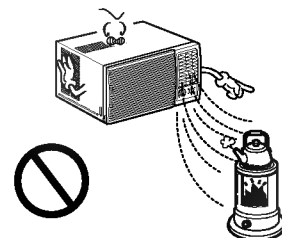

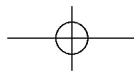

FEATURES

ENGLISH

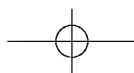
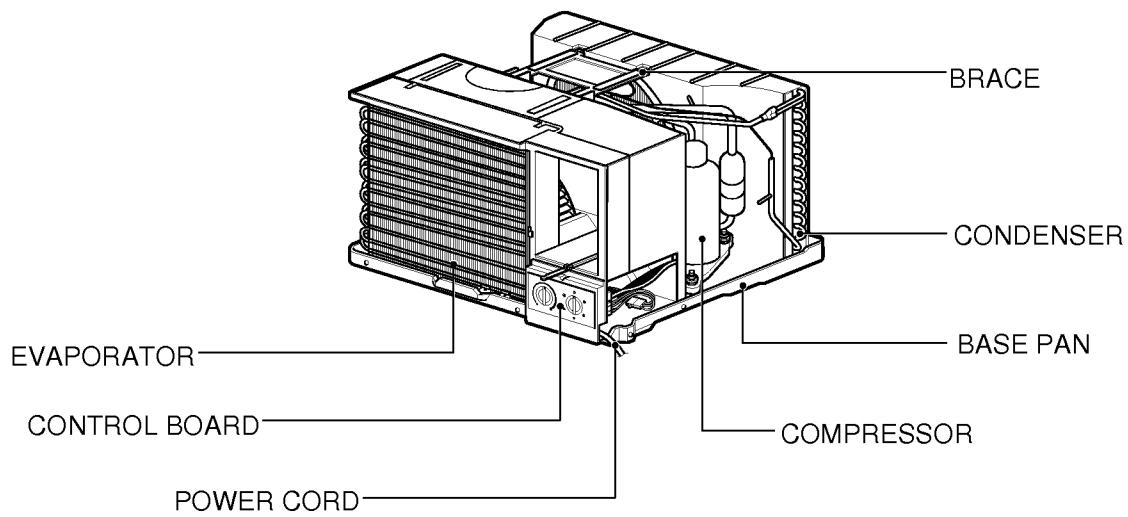
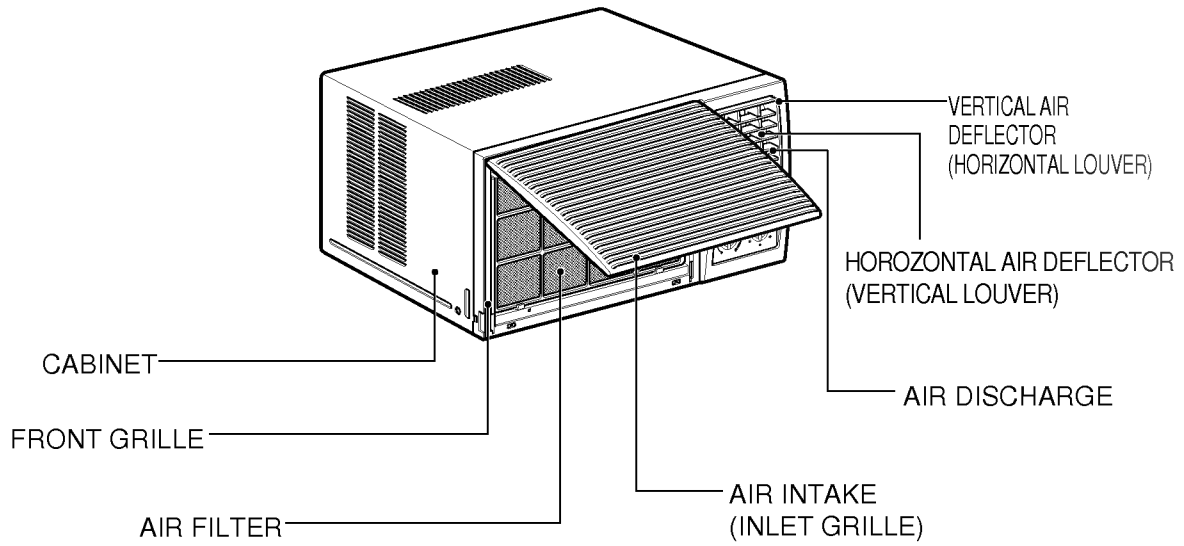

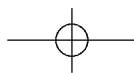

OPERATING

CAUTION

When the air conditioner has been performing its cooling operation and is turned off or set to the fan position, wait at least 3 minutes before resetting to the cooling operation again.

FUNCTION

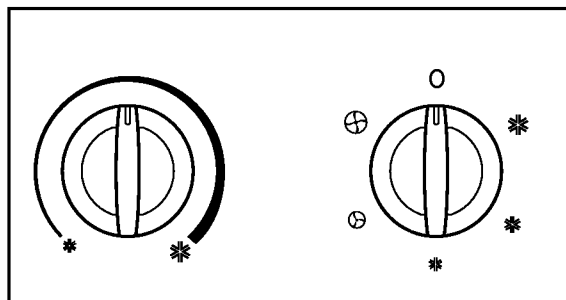
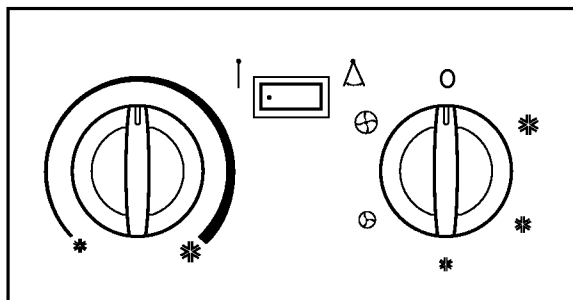

• THERMOSTAT

Thermostat will automatically control the temperature of the room. Select the right side for lower room temperature. The temperature is selected by turning the knob to the desired position.

The middle position of arc is a normal setting for average conditions.

• AUTO SWING

ON (Δ): Air swing is operated while OPERATION knob is set to the COOL position.

OFF (◻): Stops the operation of air swing.

• OPERATION

○ : Turns the air conditioner off.

⊕ : Permits the medium fan speed operation without cooling.

⊗ : Permits the low fan speed operation without cooling.

✱ : Permits cooling with the high fan speed operation.

✱ : Permits cooling with the medium fan speed operation.

✱ : Permits cooling with the low fan speed operation.

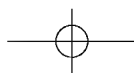

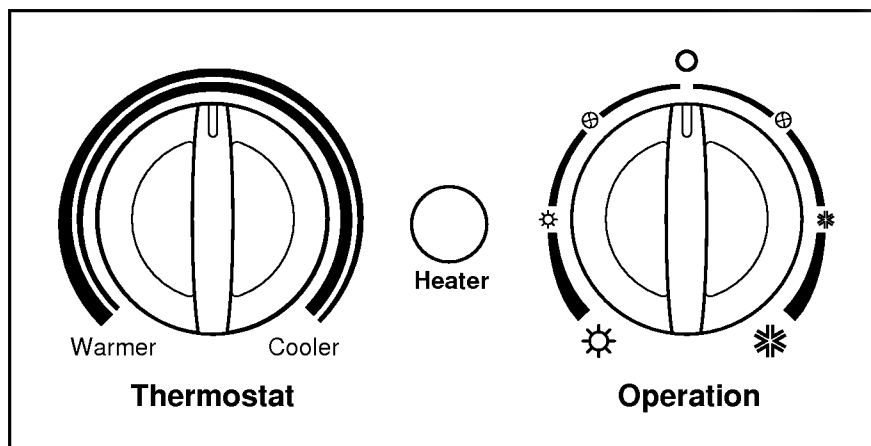
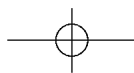

• THERMOSTAT

Turn the thermostat control to the desired setting. The central position is a normal setting for average conditions. You can change this setting, if necessary, in accordance with your temperature preference.

The thermostat automatically controls cooling or heating, but the fan runs continuously whenever the air conditioner is in operation. If the room is too warm, turn the thermostat control clockwise. If the room is too cool, turn the thermostat control anticlockwise.

• HEATER LAMP

When the unit sets heating operation condition, the green lamp is lighted.

When the frost settles on the heat exchanger of the outside, defrosting is made automatically and the green lamp is unlighted.

The unit may give a "hiss" and the fan motor stops for 1 to 10 minutes.

• OPERATION

- : Turns the air conditioner off.
- ⊕ : Permits the low fan speed operation without cooling(heating).
- * : Permits cooling with the low fan speed operation.
- * : Permits cooling with the high fan speed operation.
- ⊕ : Permits heating with the low fan speed operation.
- ⊕ : Permits heating with the high fan speed operation.

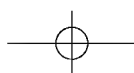

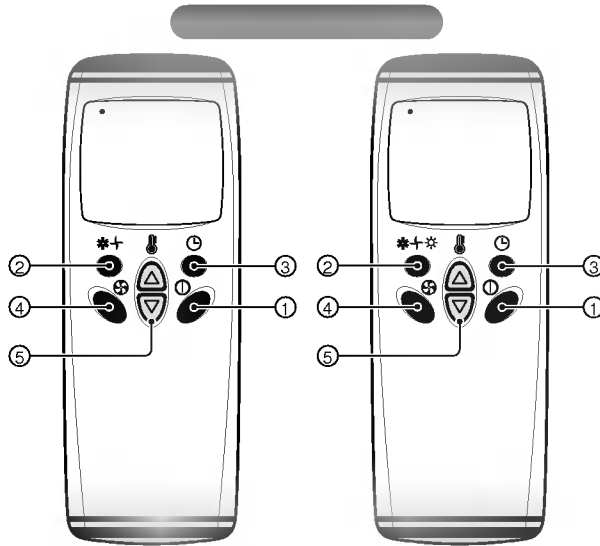
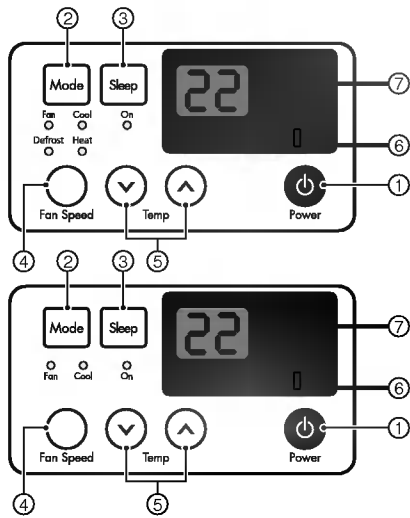
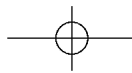

1 POWER BUTTON

Operation starts, when this button is pressed and stops when you press the button again.

2 OPERATION MODE SELECTION BUTTON

Select Cooling, Heating, or Fan mode with this button.

3 ON/OFF TIMER BUTTON

Set the time of starting and stopping operation.
The timer is set by 1 hour.

4 FAN SPEED SELECTOR

Select the fan speed. Cooling Model: 3 steps{High[F3] → Low[F1] → Med[F2] → High[F3]...}
Heating Model: 2 steps{High[F2] → Low[F1] → High[F2]...}

5 ROOM TEMPERATURE SETTING BUTTON

Control the room temperature within a range of 16°C to 30°C. The room temperature will be adjusted by 1°C 30 min., and by 2°C 1 hour later.

AUTO RESTART SWITCH

In failure of electric power, if the switch is set to "ON", the unit runs as previous setting operation when power returns.

SIGNAL RECEIVER

HOW TO INSERT BATTERIES

1 Remove the cover from the back of the remote controller.

- Slide the cover according to the arrow direction.

2 Insert the two batteries.

- Be sure that the (+) and (-) directions are correct.
- Be sure that both batteries are new.

3 Re-attach the cover.

- Slide it back into the position.

• Do not use rechargeable batteries, such batteries differ from standard dry cells in shape, dimensions, and performance.

• Remove the batteries from the remote controller if the air conditioner is not going to be used for an extended length of time.

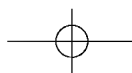
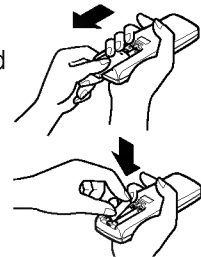

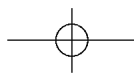

VENTILATION

The ventilation lever must be in the CLOSE position in order to maintain the best cooling conditions. When fresh air is necessary in the room, set the ventilation lever to the OPEN position. The damper is opened and room air is exhausted.

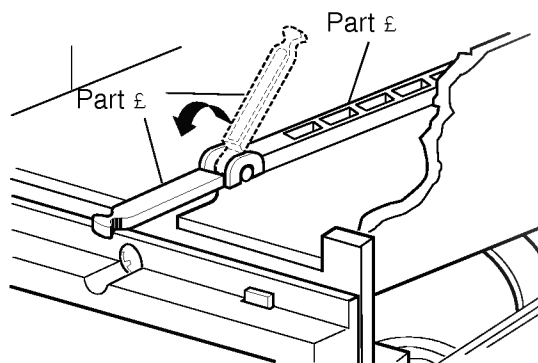
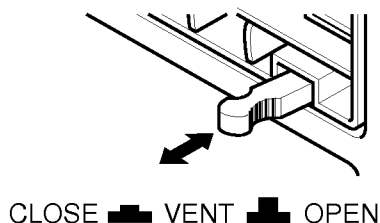

NOTE: Before using the ventilation feature, make a ventilaiton kit. First, pull down part E to E horizontal line with part E .

TO CONTROL AIR DIRECTION

The direction of air can be controlled whenever you want to cool by adjusting the horizontal louver and the vertical louver.

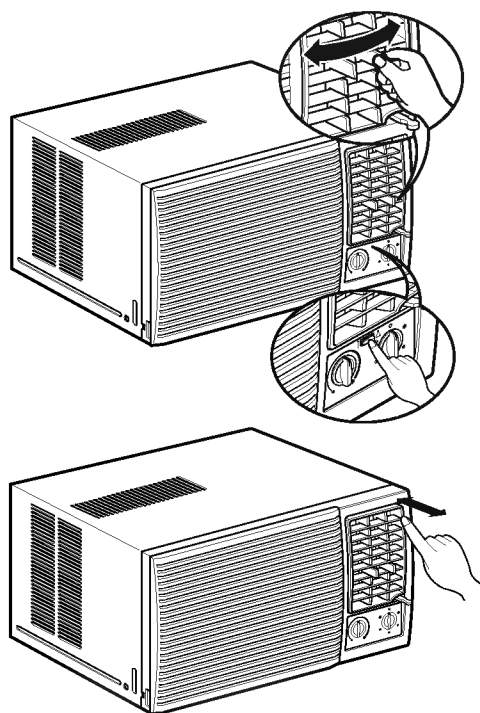

- **HORIZONTAL AIR DIRECTION CONTROL**

The horizontal air direction is adjusted by moving the vertical louver right or left.

- **AUTO SWING MODELS**

To control horizontal direction of air flow, set to the Δ (ON) position the air-swing switch and the air flow will be swept horizontally by the automatic air-swing system.

If you want to stop the air flow from moving, switch off the air swing switch at the desired position of the vane.

- **VERTICAL AIR DIRECTION CONTROL**

The vertical air direction is adjusted by adjusting the horizontal louver forward or backward.

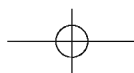

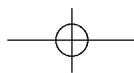

AIR FILTER CLEANING

The air filter should be checked at least twice a month to see if cleaning is necessary. Trapped particles in the filter will build up and block the airflow. This reduces the cooling capacity and also causes an accumulation of frost on the cooling coils.

1. Open the inlet grille upward by pulling out the bottom of the inlet grille.
2. Remove the air filter from the front grille assembly by pulling the air filter up slightly.
3. Wash the filter using lukewarm water below 40°C(104°F).
4. Gently shake the excess water from the filter completely. Replace the filter.

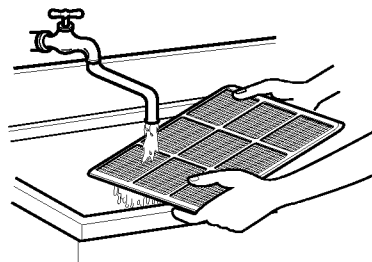
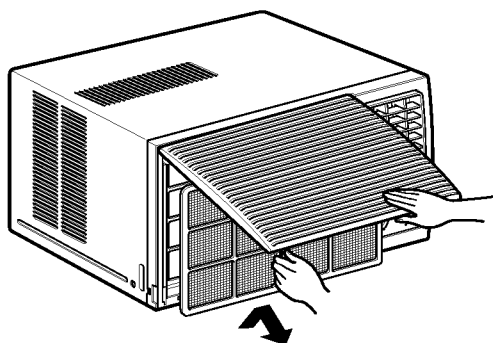

HOW TO COMBINE FRONT GRILLE WITH CABINET

1. Pull down front grille from the cabinet top.
2. Push front grille's tips toward the cabinet in order to insert front grille's tabs into the cabinet.
3. Open the inlet grille.
4. Tighten the screw through the front grille.
5. Close inlet grille.

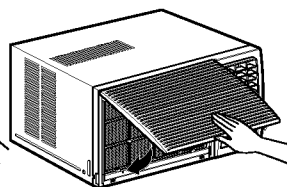
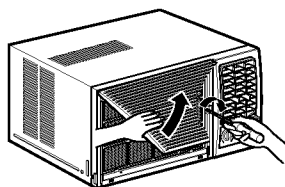
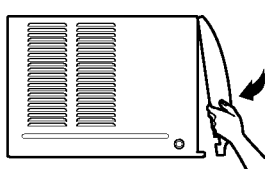
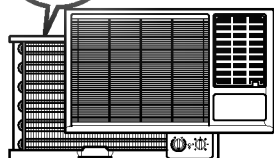

USE THE REVERSIBLE INLET GRILLE

1. If you want to pull out the filter upward, open the inlet grille slightly.
Turn inside out the front grille.
Disassemble the inlet grille from the front grille with separating the hinged part by inserting a "-" type screw-driver tip. Rotate the inlet grille 180 degrees and insert the hooks into the lower holes of front grille. Then, insert the filter.
2. If you want to pull out the filter downward, use the reversible inlet grille without change.(The grille is already assembled for that way.)

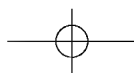
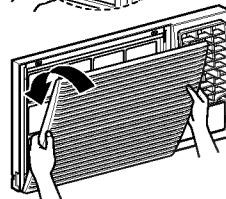
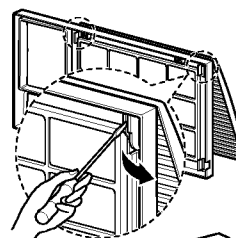

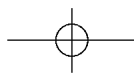

INSTALLATION

ENGLISH

If a power plug is not to be used, provide a circuit breaker between power source and the unit as shown below.

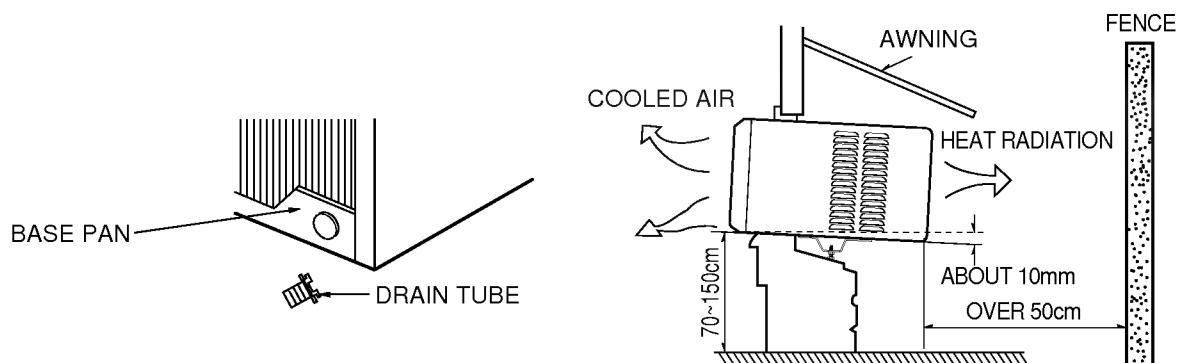
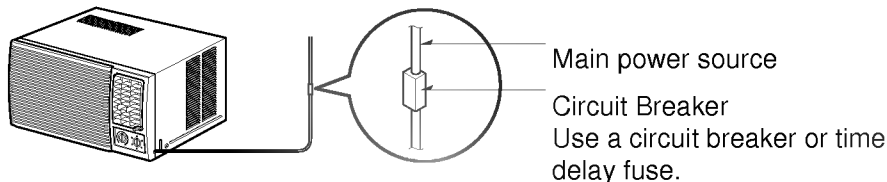

1. To avoid vibration and noise, make sure the unit is installed securely and firmly.
2. Install the unit where the sunlight does not shine directly on the unit.
If the unit receives direct sunlight, build an awning to shade the cabinet.
3. There should be no obstacle, like a fence, within 50cm which might restrict heat radiation from the condenser.
4. Install the unit a little obliquely outward not to leak the condensed water into the room (about 10mm)
5. Install the unit with its bottom portion 70-150cm above the floor level.
6. The power cord must be connected to an independent circuit. The green wire must be grounded.
7. Connect the drain tube to the base pan hole.
Plastic hose or equivalent may be connected to the drain tube.

NOTE

Before installing the Air Conditioner back into the case, remove the white styrofoam shipping block from the compressor.

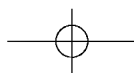
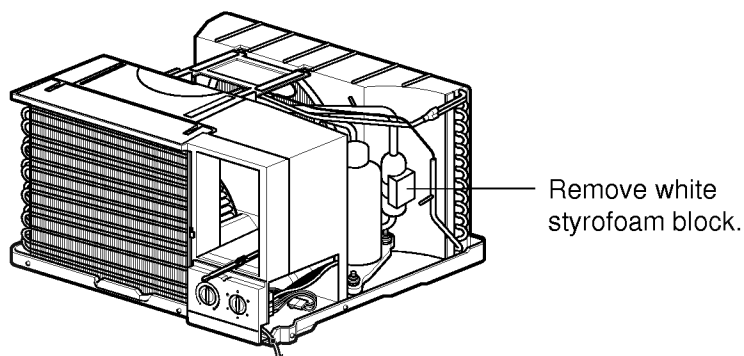

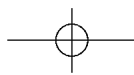

HOW TO ATTACH DRAIN PAN

The air conditioner employs a proper drain method whereby the condensate water (moisture removed from the air) is drained to the outside.

In very humid weather, (and for reverse cycle models in the reverse mode) excessive condensate water removed from the air may cause some water to collect. To remove this excess water you can install the drain pan as detailed below.

1. Take the drain pan which is located in the air discharge or on the barrier.
2. Remove the hole rubber from the base-pan(for some models).
3. Install the drain pan to the left corner of the cabinet with 4 (or 2) screws.
4. Connect the drain hose to the outlet located at the bottom of the drain pan.
You can purchase the drain hose or tubing locally to satisfy your particular needs.
(Drain hose is not supplied)

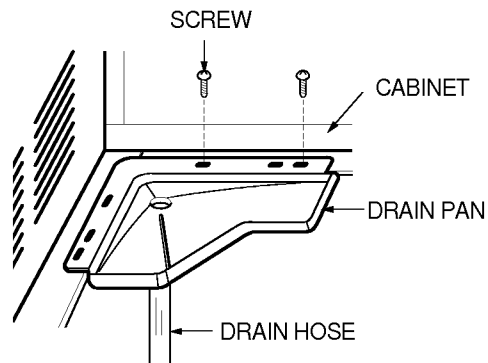

BEFORE REQUESTING SERVICE

When you find something wrong with your room air conditioner, please check carefully referring to the following items. If you can't find out the causes of trouble, get into contact with your dealer.

A. WHEN THE AIR CONDITIONER CANNOT OPERATE;

1. Is the air conditioner plugged into the receptacle properly?
2. Is there a local power failure?
Try another electrical product.
3. Has the air conditioner been accidentally switched off?
4. Is the circuit overloaded by other devices on the same line?
5. At cooling condition:
Is the thermostat set too high temperature (the lowest number position of the pannel) compared with the temperature of indoor?

B. AIR CONDITIONER RUNS, BUT DOES NOT COOL SUFFICIENTLY;

1. Is the operation switch set properly?
2. Is the thermostat control set properly to provide the desired temperature?
3. Are there too many people than the usual number in the room?
4. Is the air circulation impeded by drapes, furniture etc., or by an improper louver setting?
5. Are the doors or windows open, or is there an unusual heat source in the room?
6. Is the ventilation damper closed for maximum cooling?
7. Is the filter clean so that it will not obstruct the air flow?

NOTE

SPLASH PROOF: The outdoor side of this appliance is splash proof and the indoor side is ordinary.

