



# Washing Machine

## OWNER'S MANUAL

**WD-1041WF**

Thank you for purchasing LG Fully Automatic Washer. Please read your owner's manual carefully, it provides instructions on safe installation, use and maintenance. Retain it for future reference.

Record the model and serial numbers of your washing machine



### Protection against wrinkles

With the alternate rotation of the drum, the wrinkling in the laundry is minimized.

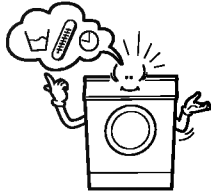

### Preferred temperature selection

There are 4 temperature selections between cold and 95°C

### Low noise speed control system

By sensing the load and balance, evenly distributes the load to minimize the spinning noise level.



### Child-Lock

The Child-Lock system has been developed to prevent children from pressing any button to change the program during operation.

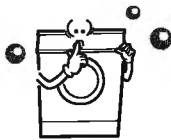

### Delay finish

Delayed Washing can be set easily from 3 hours to 19 hours.

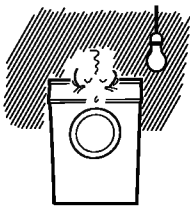

### Auto Restart

Although the washing machine is turned off by a power failure, it restarts automatically in its stopped again and the process is properly adjusted and it will be the same when the machine unplugged in operation is plugged in again.

- Warnings . . . . . 3
- Specification . . . . . 4
- Installation . . . . . 5
- Preparing your laundry . . . . . 7
- Adding detergent . . . . . 7
- Control panel . . . . . 8
- How to use your washing machine . . . . . 9
- Delayed washing . . . . . 11
- Maintaining . . . . . 12
- Trouble-shooting guide . . . . . 14

# Warnings

**You must read the whole of this instruction book before you use the appliance.**

**Follow the advice carefully.**

**Keep the book for future reference. If you sell or give away the appliance, make sure that the book is passed to the new owner.**

**The following warnings are provided in the interests of overall safety.**

**You must read them before the appliance is installed or used.**

This appliance is designed to be used by adults. Children should not be allowed to touch the controls or play with the product.

It is dangerous to modify the specifications of this appliance in any way.

This appliance is heavy. Care should be taken when moving it.

All packaging and transit bolts must be removed before the appliance is used.

Serious damage may occur if this is not done.

Any plumbing work required to install this appliance should be carried out by a qualified plumber or a competent person.

Any electrical work required to install this appliance should be carried out by a qualified electrician or a competent person.

Make sure that the appliance does not stand on its electrical supply cable.

If the machine is situated on a carpeted floor, please adjust the feet to ensure that air can circulate freely.

Always unplug the appliance and turn off the water tap after use.

Do not overload the appliance.

Only wash fabrics which are designed to be machine washed. If in doubt, follow the instructions you find on the label of the item itself.

Avoid electric heaters, candles, etc. near the machine. It may ignite or deform the machine.

Don't sprinkle water. It may cause a fire or electric shock.

Use the exclusive 220-240V outlet with ground terminal. Do not use an extension cord or double adapter.

Make sure that all pockets are empty. Hard, sharp objects such as coins, safety pins, nails, screws or stones can cause extensive damage.

Do not wash laundry stained with edible oil, machine oil, dry-cleaning oil, gasoline, etc. It may cause fire or explosions.

This appliance is designed for domestic use. It must not be used for purposes other than those for which it was designed.

Do not machine wash fabrics which are saturated with petroleum products. If volatile cleaning fluids have been used, make sure that they are thoroughly removed from the fabric before it is placed in the appliance.

Do not operate near places with ignitable material such as gasoline, benzene, etc. or inflammable gas leak. Due to volatile nature of these material, It can cause fire or explosions.

Use only the recommended quantities of fabric softener. An excessive amount could damage the laundry.

Leave the porthole door slightly ajar between washes to preserve the door seal.

Before you open the door of the machine check that the water has drained. Do not open the door if you can still see water.

Pets and children may climb into the washing machines. Check your appliance each time before use.

The glass door becomes very hot during washing. Keep children away from the appliance while it is in use.

You should not attempt to repair the machine yourself. Repairs carried out by inexperienced or unqualified persons may cause injury and/or more serious faults to the machine.

This product should be serviced by an authorized Service Centre only, and only genuine spare parts should be used.

When disposing of your old washing machine, the electric cable must be cut off and the door catch must be made inoperative to avoid it becoming a death trap for a child.

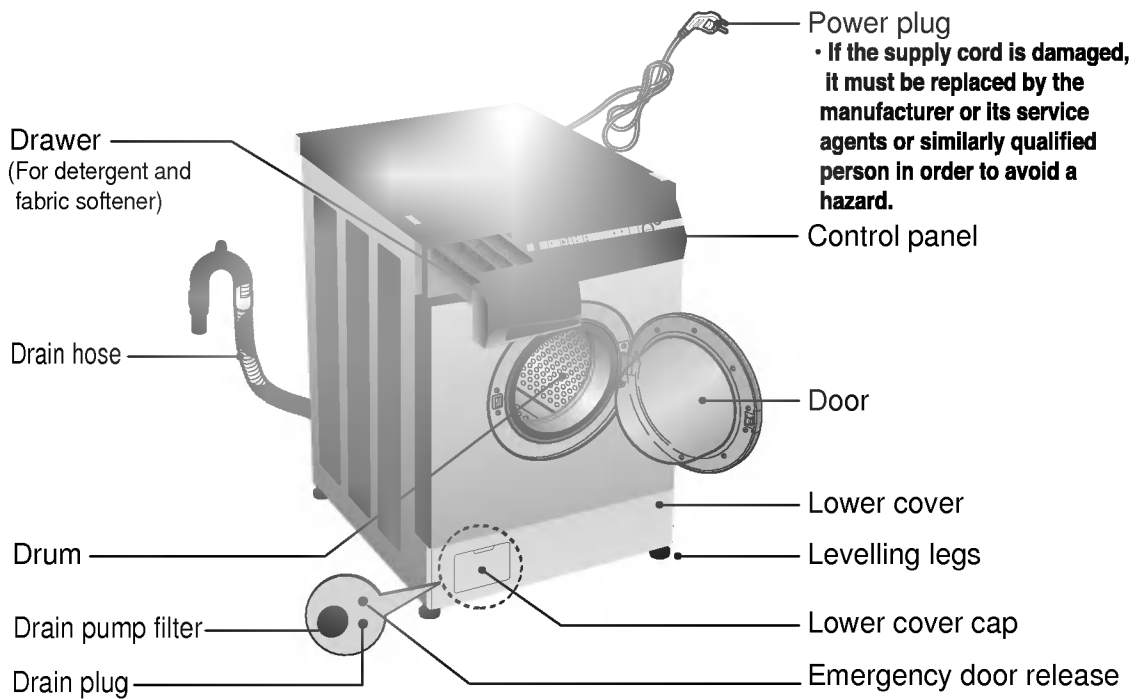

Name	:	Front loading washing machine
Power supply	:	220-240V, 50Hz
Size	:	600mm(W) × 600mm(D) × 850mm(H)
Weight	:	67kg
Wash capacity	:	7.0kg
Heating	:	2200W
Spin speed	:	600/800/1000 rpm
Wash consumption	:	67 ℓ (9.6 ℓ / kg )
Permissible water pressure	:	0.3-10kgf/cm <sup>2</sup> (30-1000kPa)

The appearance and specifications may be varied without notice to raise the units quality

### Accessories

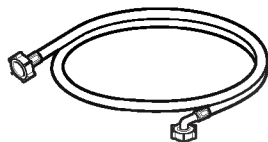

Inlet hose(1EA)

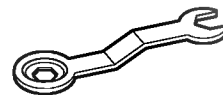

Spanner

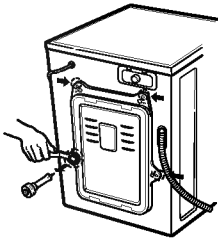

Keep the transit bolts and spanner for future use in case the machine is to be transported again.

## How to disassemble the transit bolts.

To protect the washer during transportation, the special 4 bolts are locked. Before operating the washer, remove the bolts.

(If they are not removed, it may cause heavy vibration, noise and malfunction)

1. Locate the 4 bolts that secures the back cover.
2. Unscrew the 4 bolts with a spanner provided.
3. Take out the 4 bolts.

## Level adjustment

### 1. Select a place for installation

Place it at a firm and even floor

Place it more than 2cm away from the wall or other furniture

### 2. Check the gap

Ensure all feet are firmly on the floor.

### 3. Level adjustment

After adjusting the level, check it by shaking the washer.

Readjust the level if necessary.

Levelling should be done within 1.5 degree angle.

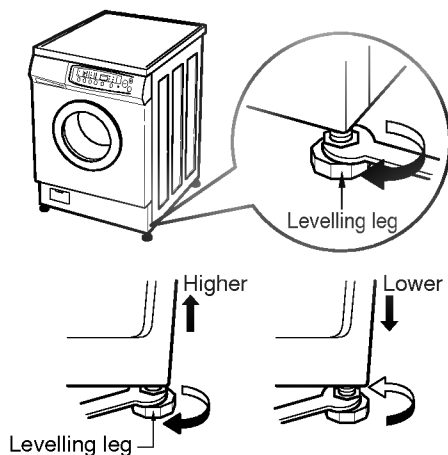

If the washer is not levelled, it may cause noise or vibration.

## Electrical connection

Do not use an extension cord or double adapter.

If the supply cord is damaged, it must be replaced by the manufacturer or its service agents or similarly qualified person in order to avoid a hazard.

Always unplug the machine and turn off the water supply after use.

Connect the machine to an earthed socket in accordance with current wiring regulations.

If the appliance is supplied from a cord extension set or electrical portable outlet device, the cord extension set or electrical portable outlet device should be positioned so it is not subject to splashing or ingress of moisture.

If a stationary appliance is provided with a supply cord and a plug, the instructions shall state that the appliance must be positioned so that the plug is accessible.

## Water drain

Hook over the edge of a sink using the plastic hose hanger supplied with the machine.

Make sure there are no kinks in the hose and that it is not crushed.

Secure the hose so that it can not be dislodged while the appliance is running.

The drain hose should not be placed higher than 85cm above the floor.

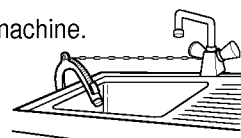

# Installation

## Connecting the inlet hose

1. Unscrew the fixing screw to attach the faucet.
2. Push the connector up till the rubber packing is in tight contact with the faucet. Then tighten the 4 screws.
3. Push the water supply hose vertically upwards so that the rubber packing within in the hose can adhere completely to the faucet and then tighten it by screwing it to the right.

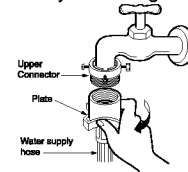
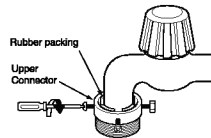
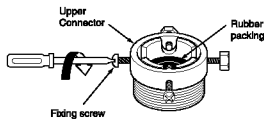

## Connecting the inlet hose (How to connect the hose of one touch type.)

1. Untighten the upper connector screw.
2. Push the upper connector up till the rubber packing is in tight contact with the faucet. Then tighten the 4 screws.
3. Connect the water supply hose to the middle connector, pushing the plate down.

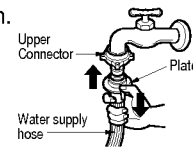
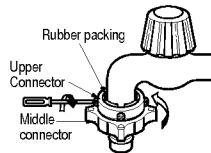
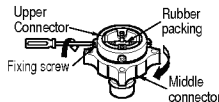

- In case the diameter of the faucet is large remove the guide plate.

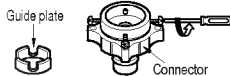

- Turn the middle connector not to have water leaked.

- To separate the water supply hose from the middle connector sut off the fauce. Then pull the inlet hose down, pushing the plate down.

Used the horizontal faucet	
Horizontal faucet	
Extension faucet	
Square faucet	

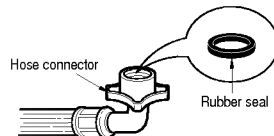

- Make sure that the rubber seal is inside the hose connector.

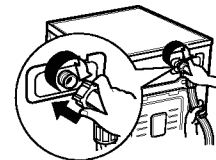

- Your machine comes with only cold water connection.
- Make sure that there are no kinks in the hose and that it is not crushed.

## Connecting the inlet hose (How to connect the hose of screw type.)

- Two rings are supplied with the water inlet hose in the valve connector in order to prevent water leaks.
- Your machine comes with only cold water connection. Connect to cold water using the inlet valve.
- Check water tightness of washing machine connections by turning the tap completely on.
- Periodically check the condition of the hose and replace the hose if necessary.
- Make sure that there are no kinks in the hose and that it is not crushed.

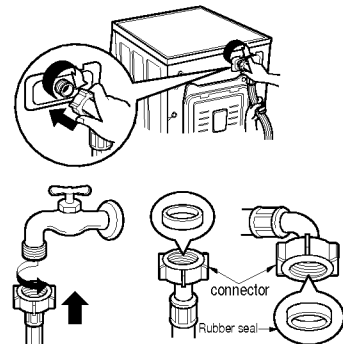



Check pocket for any articles (coin, safety pin, paper clips, etc.)  
 Close zips and fasten button or hooks : loose belt or ribbons should be tied together.  
 Never wash whites and coloureds together.  
 Follow the wash code symbols on each garment label and manufacturer's washing instructions.

Soiled condition	Washing	Temperature
Heavily soiled	- Pre wash - Main wash	Heavily soiled cottons : cold - 95°C Normally soiled cottons : cold - 95°C Colored cottons : cold - 60°C
Normally Soiled	- Main wash	Synthetics : cold - 60°C Delicate fabrics : cold - 40°C Woollens : cold - 40°C

## Where to place the detergent

Pull out the detergent drawer.  
 Put the detergent and fabric softener in the detergent drawer before washing.  
 Close the detergent drawer completely.

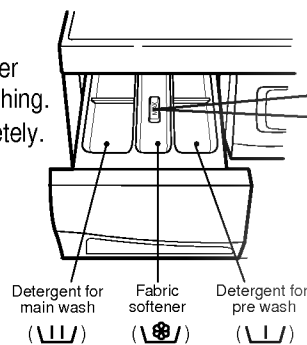

### The drawer for fabric softener

- Do not leave the fabric softener in the detergent drawer for more than 2 days. (Fabric softener could harden)
- Do not open the drawer during water fill cycle.
- Softener will automatically add during last rinsing cycle.
- Do not fill past MAX indicator.
- Do not use solvents (benzine, etc.)

Softener level



- Programs with PRE-WASH (M) (P)
- MAIN-WASH only (M)



The detergent should be used according to the instruction of the detergent manufacturer.  
 If the detergent is used over the recommended amount too many bubbles will be generated thus causing an inferior washing result. Which will cause malfunction.  
 Use detergent only for drum washing machine.

## Detergent dosages

Do not exceed manufacturer's recommended dosages as shown on the detergent package.

The amounts depend on

- degree and type of soiling
- amount of wash
  - full load : according to manufacturers' instructions
  - part load : 3/4 of the normal amount
  - minimum load (about 1kg) : 1/2 the amount used for full load

Water hardness in your area.

## Choosing the right detergent

The type of detergent depends on

- the type of fabric (cotton, synthetic, delicate items, wool)
- colour
- wash temperature
- degree and type of soiling

NOTE : use appropriate detergent only for wool

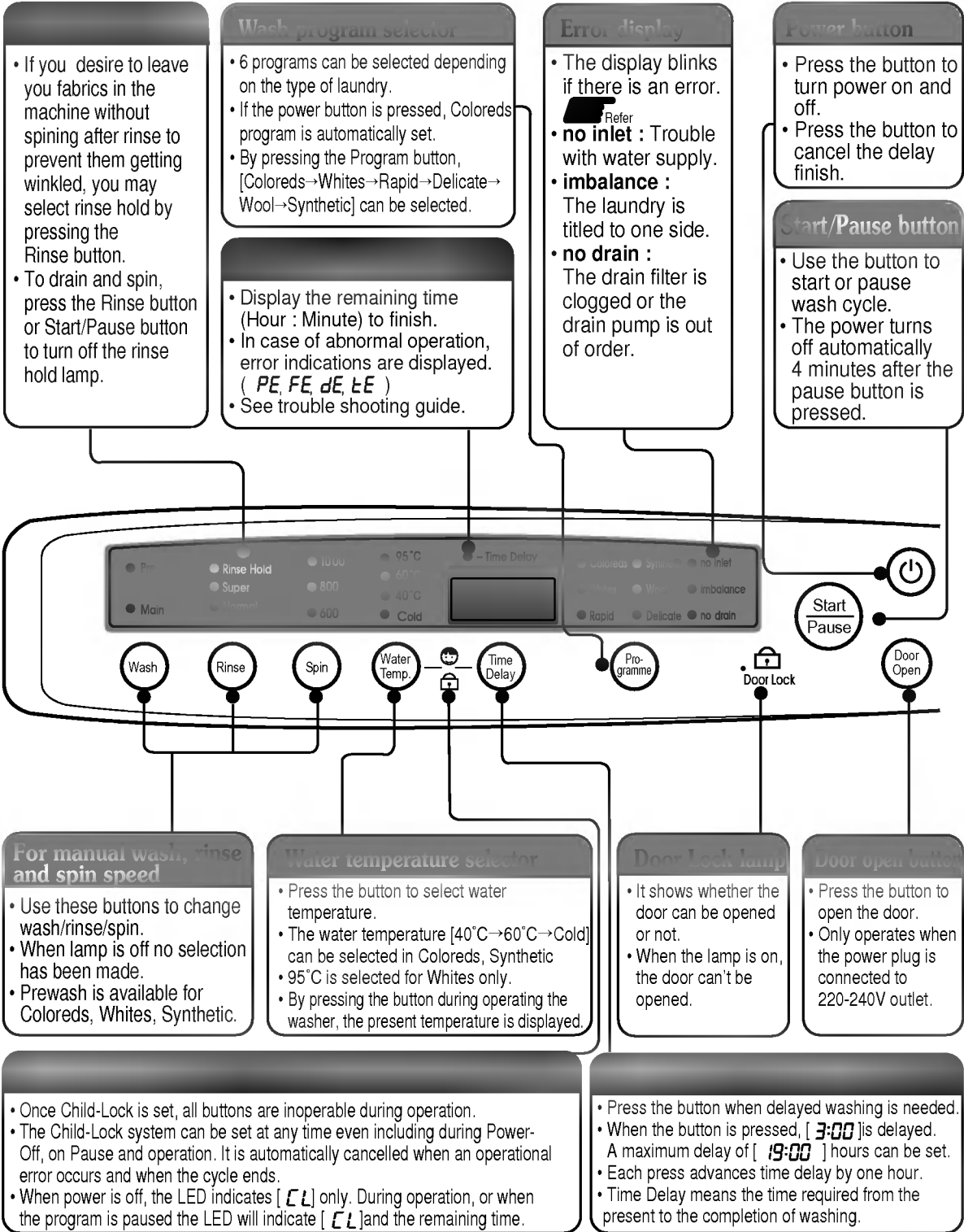



## The whole washing process is carried out automatically with just one touch.

(If no program is selected, Coloreds program will commence.)

### Prepare the washing

- Make sure that the machine is plugged in the electric supply.
- Turn on the cold water tap.
- Press the Door Open button.
- Load the laundry and close the door.
- Put the detergent and fabric softener into drawer.

### In case of automatic washing

1. Press the Power button.
2. Press the Start/Pause button to start the washing machine.  
The coloreds program is carried out automatically.
3. The optimum wash program is selected once the load is detected.

### To change the washing program

1. Press the Power button.
2. [Coloreds Whites Rapid Delicate Wool Synthetic] will appear in order by pressing the Program button.

Make adjustment to water temperature, rinse or spin cycles to suit your wash needs by pressing these buttons.

		• Select the function to change rinse, spin and water temperature. • ( ) indicates manual operations.				Washing time
		Wash	Rinse	Spin	Water Temp	
<b>Coloreds</b>	Colored blouses, aprons, shirts, bed linen	Main wash (Pre + Main)	Normal(Super) (Normal+Rinse Hold) (Super+Rinse Hold)	800 (600, 1000)	40°C (Cold, 60°C)	about one hour & 46 minutes
<b>Whites</b>	First check if the laundry is machine washable. White cottons and linen(towels, sheets...)	Main wash (Pre + Main)		800 (600, 1000)	95°C	about 2 hours & 23 minutes
<b>Rapid</b>	For quick washing of less dirty laundry or frequently used towels.	Main wash		800 (600, 1000)	Cold (40°C)	about 43 minutes
<b>Delicate</b> (Below 3.0kg)	Delicate laundry easily damaged.(silk, curtains.....)	Main wash		600	Cold (40°C)	about one hour & 9 minutes
<b>WOOL</b> (Below 1.0kg)	Machine washable woollens with pure new wool only.	Main wash		600	Cold (40°C)	about 45 minutes
<b>Synthetic</b> (Below 4.0kg)	Polyamide, Acrylic, Polyester	Main wash (Pre + Main)		800 (600, 1000)	40°C (Cold, 60°C)	about one hour & 46 minutes

3. Press the Start/Pause button to start the cycle.



### Completion of washing

- If the washing is completed, the display shows [ End ] with a beep. Press the Door Open button and take out the laundry.
- Switch off the appliance and turn off the tap.

# How to use your washing machine

## More convenient manual operations of Coloreds program

It is more convenient to operate manually in Coloreds program than in others because Coloreds program is firstly set with power on.

### In Coloreds,

When you want wash only, press the Wash button to select the washing method.

When you want rinse only, press the Rinse button to select the rinsing method.

When you want spin only, press the Spin button to select the Spin speed.

When you want wash and rinse only, press the Wash button and Rinse button to select each method.

When you want rinse and spin only, press the Rinse button and Spin button to select each method.

## The Child-Lock system

The Child-Lock system can be programmed and cancelled by pressing the both Water Temp. and Time Delay buttons simultaneously.

**Child-Lock** (If you want to lock all the buttons to prevent all the setting from a child or infirm persons, you can use this option.)

If you want to change the program when the Child-Lock system is on,

1. Press both **Water Temp.** and **Time Delay** buttons.
2. Press the **Start/Pause** button.
3. Change the desired program and press the **Start/Pause** button.

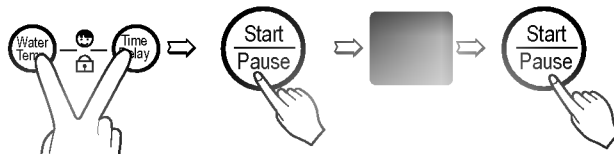

If you want to deactivate Child-Lock during wash cycle, press both Water Temp. and Time Delay simultaneously.



If the lamp turn off, the door can be open by pressing the Door Open button, additional laundry can be put in during the washing. In other words, it shows whether the door can be open or not.

In case of adding laundry (when is off)

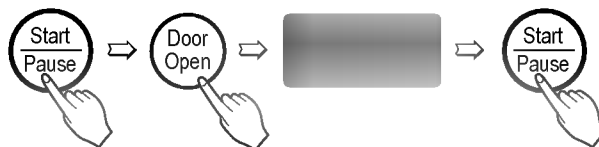

If the lamp is on, select spin cycle to drain water and press the Start/Pause button and than Door Open button to open the door.

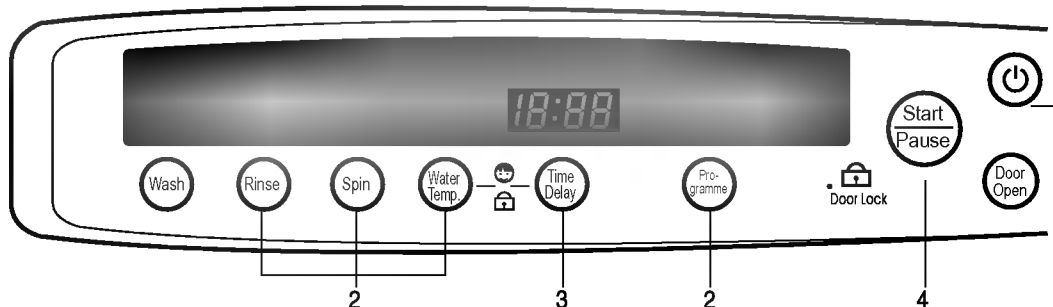

### Prepare the washing

- Plug the power into the exclusive 220-240V outlet.
- Turn on the water tap.
- Put in the laundry and close the door.
- Place the detergent and fabric softener in the drawer.

#### 1. Press the Power button

#### 2. Press the Program selection button to select the program you require.

Select the rinse, spin and the water temperature.

#### 3. Press the Time Delay button

Select the finish time you require by pressing the Time Delay button.

### Time Delay setting.

**Example)** If you want to complete the washing after 5 hours, press the Time Delay button and adjust the time.

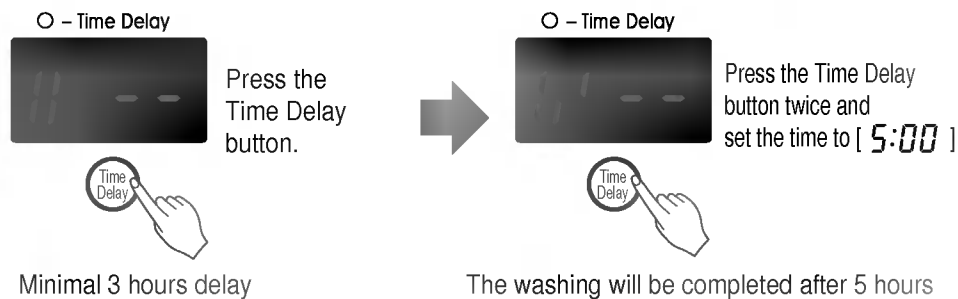

Time delay is possible between 3 to 19 hours and not possible under 3 hours.  
 Time delay does not proceed during power failure.  
 According to the condition of water supply and temperature, the delayed time and the actual washing time can be slightly different.  
 The Power button can be use to cancel the time delay.  
 Each press advances Time Delay by one hour.

#### 4. Press the Start / Pause button

All lamps except the time delay and the remaining time display will be turned off.



#### The washing is completed at the selected time

Unplug the appliance and turn off the tap.

#### The washing program for when you go out.

If you are unable to unload the washing machine at the end of delay cycle, it is best not to select the spin cycle or use [Rinse Hold].

Unplug the power plug prior to maintaining  
Clean the filter periodically every 3 months.

### Clean the filter in the inlet valve

When no water flows through detergent drawer, or filter is clogged with foreign material "no inlet" is displayed of the control panel.

1 Turn off the water tap.

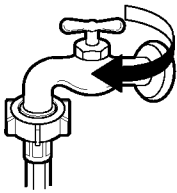

2 Unplug the power plug from the outlet.

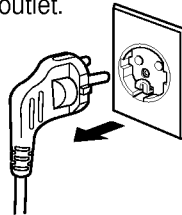

3 Disconnect the inlet hose

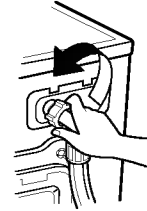

4 Pull out the filter with a tool or by hand and clean it using a toothbrush.

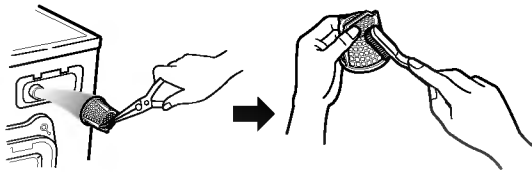

5 Connect the inlet hose and check water leakage.

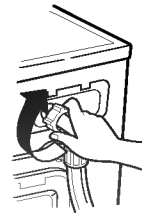

Insert the filter in its original place.

### Clean the drain pump filter

1 Open the lower cover cap ( ) by using coin. Turn the drain plug ( ) to pull out the hose.

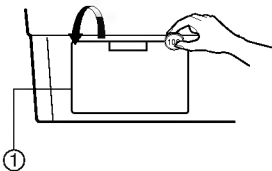

2 Unplug the drain plug ( ), then the water flows out. At this time use a vessel to prevent water flowing on the floor. If the water does not flow any more, turn the pump filter ( ) open to the left.

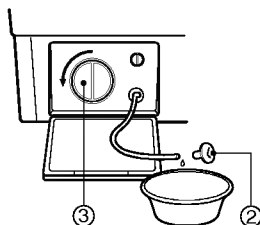

3 Take out any foreign material from the pump filter ( ). After cleaning, turn the pump filter ( ) clockwise and insert the drain plug ( ) to the original place. Close the lower cover cap.

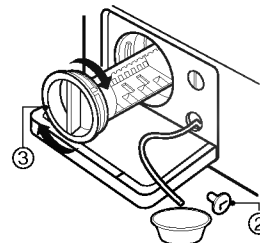

### Clean the filter in the inlet valve

1 Turn off the water tap and remove the inlet hose.

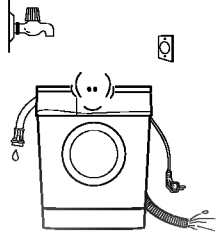

2 Drain water in the machine using drain plug ( ).

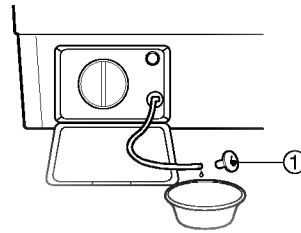

### When the machine is frozen

1 Pour hot water (about 50°C) on the faucet and remove the inlet hose.

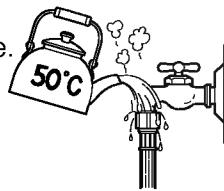

2 Submerge the separated hose in hot water (about 50°C).

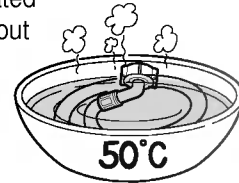

3 Pour the hot water in the drawer and maintain it for 10 minutes for melting.

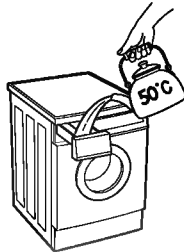

4 Connect the inlet hose to the water tap and check the drain after turning on the water tap and operating the washing machine.

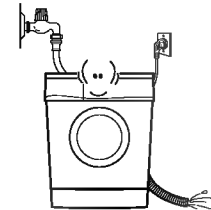

### Maintenance of the drawer

1 Pull out the drawer slightly upware.

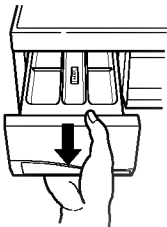

2 Wash it clearly.

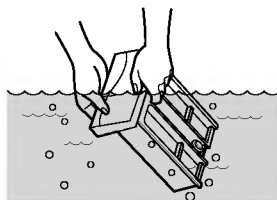



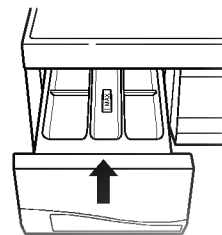





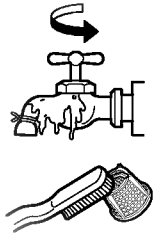

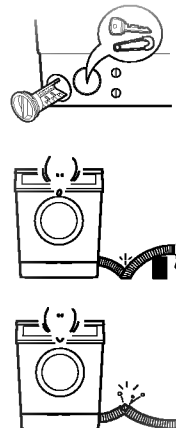

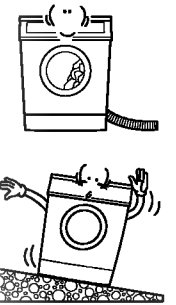

3 Insert it in its original place.

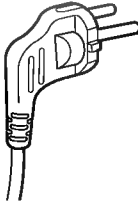
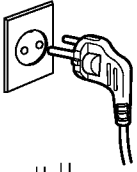
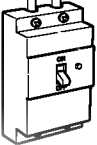

# Trouble – Shooting guide

Check the following before asking for service if the error message is displayed during washing, rinsing, spinning.  
Request for service in the case of failure or damage except the followings.

Symptom	Check points	Solution
	 <ul style="list-style-type: none"> <li>• Is the water tap turned off ?</li> <li>• Is the water frozen?</li> <li>• Is the water pressure low or the filter clogged ?</li> </ul>	<ul style="list-style-type: none"> <li>• Turn the water tap on.</li> <li>• Melt it with 50°C hot water <b>13</b> Refer</li> <li>• Disconnect the inlet hose and clean the filter. <b>12</b> Refer</li> </ul>
	 <ul style="list-style-type: none"> <li>• Is there foreign matter in the drain filter ?</li> <li>• Is the drain hose bent or higher than 85cm above the floor ?</li> <li>• Is the hose clogged ?</li> <li>• Is the hose frozen ?</li> </ul>	<ul style="list-style-type: none"> <li>• Clean and remove foreign material from drain filter. <b>12</b> Refer</li> <li>• Put the drain hose evenly.</li> <li>• Place the drain hose under 85cm from the floor. <b>6</b> Refer</li> <li>• Melt it with 50°C hot water. <b>13</b> Refer</li> </ul>
	 <ul style="list-style-type: none"> <li>• Is the laundry tilted to one side in the drum?</li> <li>• Is the washer leveled?</li> </ul>	<ul style="list-style-type: none"> <li>• Spread the laundry evenly.</li> <li>• Release imbalance by pressing the [Start / Pause] button. If it happens after rinsing or spinning, call for service.</li> <li>• Install it on a firm and even floor. <b>5</b> Refer</li> </ul>
	 <ul style="list-style-type: none"> <li>• Is the door opened?</li> </ul>	<ul style="list-style-type: none"> <li>• Close the door.</li> <li>• * If [ dE ] is not released, call for service.</li> </ul>
		<ul style="list-style-type: none"> <li>• Unplug the power plug and call for service</li> </ul>

Symptom	Check points	Solution
	If the water overfills due to the abnormal water valve, you will get "FE," display.	<ul style="list-style-type: none"> <li>• Close the water tap.</li> <li>• Unplug the power plug.</li> <li>• Call for service</li> </ul>
	"PE," is displayed if the water level sensor malfunctions.	
   	<ul style="list-style-type: none"> <li>• Did you press the [ Power ] button?</li> <li>• Is the power plug unplugged?</li> <li>• Is the power supply correct?</li> <li>• Is the short-circuit breaker turned off?</li> </ul>	<ul style="list-style-type: none"> <li>• Turn it on.</li> <li>• Plug it to power supply.</li> <li>• Use exclusive 220-240V outlet with ground terminal.</li> <li>• Turn it on.</li> </ul>
	 <ul style="list-style-type: none"> <li>• Did you use more detergent than recommended?</li> <li>• Did you use low suds detergent for the front loading washing machine?</li> </ul>	<ul style="list-style-type: none"> <li>• Use the recommended amount.</li> <li>• Use detergents for front loading washing machines only.</li> </ul>
	 <ul style="list-style-type: none"> <li>• Did you remove the transit bolts?</li> <li>• Is the washer tilted?</li> <li>• Is the drain pump clogged with foreign matters ?</li> <li>• Is the washer loaded with excessive clothes?</li> </ul>	<ul style="list-style-type: none"> <li>• Remove it.</li> <li>• install it on the firm and even floor and level it.</li> <li>• Remove foreign matter from the drain filter.</li> <li>• Remove the excessive loads.</li> </ul> <p><b>12</b> Refer</p>