

# Color Monitor

USER GUIDE  
BENUTZERHANDBUCH  
MANUEL D'UTILISATION  
GUIDA UTENTE  
GUIA DEL USUARIO

MODEL:CS990DC

USER GUIDE

CS990DC Color Monitor

## AGENCY REGULATORY NOTICE

---

### FCC Compliance Statement

This equipment has been tested and found to comply with the limits for a Class B digital device pursuant to Part 15 of the FCC Rules. These limits are designed to provide reasonable protection against harmful interference in a residential installation.

This equipment generates, uses, and can radiate radio frequency energy and if not installed and used in accordance with the instructions, may cause harmful interference to radio communications. However, there is no guarantee that interference will not occur in a particular installation.

If this equipment does cause harmful interference to radio or television reception (which can be determined by turning the equipment off and on), the user is encouraged to try to correct the interference by using one or more of the following measures:

- Reorient or relocate the receiving antenna.
- Increase the separation between the equipment and the receiver.
- Connect the equipment into an outlet on a circuit different from that to which the receiver is connected.
- Consult the dealer or an experienced radio/TV technician for help.

**Caution:** Changes or modifications not expressly approved by the party responsible for compliance could void the user's (or your) authority to operate the equipment. Only peripherals (digital input/output devices, terminals, printers, etc.) certified to comply with the Class B limits may be attached to this monitor. Operation with non-certified peripherals is likely to result in interference to radio and TV reception.

Only shielded Signal Cables may be used with this System.

---

**Canadian  
D.O.C.  
Notice**

This Class B digital apparatus meets all requirements of the Canadian Interference-Causing Equipment Regulations.

Cet appareil numérique de la classe B respecte toutes les exigences du Règlement sur le matériel brouilleur du Canada.

**CE  
Conformity  
Notice**



Products with the "CE" Marking comply with the EMC Directive(89/336/EEC) and LOW VOLTAGE Directive (73/23/EEC) issued by the Commission of the European Community.

Compliance with these directives implies conformity to the following European Norms :

EN 55022 ; Radio Frequency Interference  
EN 50082-1:1992 ; Electromagnetic Immunity  
EN 60555-2 ; Power Line Harmonics  
EN 60555-3 ; Voltage Fluctuations  
EN 60950 ; Product Safety

## Table of Contents

---

<b>Introduction</b>	
Features .....	A1
<b>Monitor Registration</b>	
Notice .....	A2
Trademark Acknowledgments .....	A2
<b>Important Precautions</b>	
On Safety .....	A3
On Installation .....	A4
On Cleaning .....	A4
On Repacking .....	A4
<b>Connecting the monitor</b>	
Connection to any IBM VGA PC compatible system .....	A5
Connecting to an Apple Macintosh PC .....	A6
<b>Location and Function of Controls</b>	
Front View .....	A7
Rear View .....	A7
<b>Control Panel Function</b>	
OSD Enter Button .....	A8
OSD Exit Button .....	A8
OSD Select/Adjustment Buttons .....	A8
Brightness Adjustment Control .....	A8
Contrast Adjustment Control .....	A8
Power (DPMS) Indicator .....	A8
Power ON/OFF Button .....	A8
<b>On Screen Display (OSD) Control Adjustment</b> .....	A9
<b>On Screen Display (OSD) Selection and Adjustment</b> .....	A10
<b>Video Memory Modes</b>	
Display Modes (Resolution) .....	A16
User Modes .....	A16
Recalling Display Modes .....	A16
<b>Energy Saving Design</b>	
Power Consumption .....	A17
<b>MPR II, Self Diagnostics and DDC</b>	
Low Radiation Compliance (MPR II) .....	A18
Self Diagnostics .....	A18
DDC (Display Data Channel) .....	A18
<b>Troubleshooting and Service</b>	
Troubleshooting .....	A19
Service .....	A20
<b>Specifications</b>	
Specifications .....	A21

## Introduction

---

Thank you for purchasing a high resolution monitor. It will give you high resolution performance and convenient reliable operation in a variety of video operating modes.

### Features

- The monitor is a 19-inch (18.0-inch viewable ) intelligent, microprocessor based monitor compatible with most analog RGB (Red, Green, Blue) display standards, including IBM PC®, PS/2®, Apple®, Macintosh®, Centris®, Quadra®, and Macintosh II family.
- The monitor provides crisp text and vivid color graphics with VGA, SVGA, XGA, and VESA Ergo modes (non-interlaced), and most Macintosh compatible color video cards when used with the appropriate adaptor. The monitor's wide compatibility makes it possible to upgrade video cards or software without purchasing a new monitor.
- Digitally controlled auto-scanning is done with the microprocessor for horizontal scan frequencies between 30 and 96kHz, and vertical scan frequencies between 50-160Hz. The microprocessor-based intelligence allows the monitor to operate in each frequency mode with the precision of a fixed frequency monitor.
- The microprocessor-based digital controls allow you to adjust conveniently a variety of image controls by using the OSD (On Screen Display).
- The monitor has 31 memory locations for display modes, 5 of which are factory preset to popular video modes.
- This monitor is capable of producing a maximum horizontal resolution of 1600 dots and a maximum vertical resolution of 1200 lines. It is well suited for CAD work and sophisticated windowing environments.
- For greater user health and safety, this monitor complies with the stringent Swedish TCO'95 requirements for low radiation emissions.
- For low cost of monitor operation, this monitor is certified as meeting the EPA Energy Star requirements, and utilizes the VESA Display Power Management Signalling (DPMS) protocol for power saving during non-use periods.

## Monitor Registration

---

The model and serial numbers are found on the rear of this unit. These numbers are unique to this unit and not available to others. You should record requested information here and retain this guide as a permanent record of your purchase. Staple your receipt here.

Date of Purchase : \_\_\_\_\_  
Dealer Purchased From : \_\_\_\_\_  
Dealer Address : \_\_\_\_\_  
Dealer Phone No. : \_\_\_\_\_  
Model No. : \_\_\_\_\_  
Serial No. : \_\_\_\_\_

### Trademark Acknowledgments

**IBM** is a registered trademark and **VGA** is a trademark of International Business Machines Corporation.

---

**Warning :** To reduce the risk of fire or electric shock, do not expose this appliance to rain or moisture.

**Avertissement :** Ne pas placer cet appareil dans un endroit humide. Cela peut entraîner un incendie ou une décharge électrique.

## Important Precautions

---

This unit has been engineered and manufactured to assure your personal safety, but improper use can result in potential electrical shock or fire hazard. In order not to defeat the safeguards incorporated in this monitor, observe the following basic rules for its installation, use, and servicing. Also follow all warnings and instructions marked directly on your monitor.

### On Safety

---

Use only the power cord supplied with the unit. In case you use another power cord, make sure that it is certified by the applicable national standards if not being provided by the supplier. If the power cable is faulty in any way, please contact the manufacturer or the nearest authorized repair service provider for a replacement.

Operate the monitor only from a power source indicated in the specifications of this manual or listed on the monitor. If you are not sure what type of power supply you have in your home, consult with your dealer.

Overloaded AC outlets and extension cords are dangerous. So are frayed power cords and broken plugs. They may result in a shock or fire hazard. Call your service technician for replacement.

### Do not Open the Monitor

- There are no user serviceable components inside.
- There are Dangerous High Voltages inside, even when the power is OFF.
- Contact your dealer if the monitor is not operating properly.

### To Avoid Personal Injury :

- Do not place the monitor on a sloping shelf unless properly secured.
- Use only a stand recommended by the manufacturer.
- Do not try to roll a stand with small casters across thresholds or deep pile carpets.

### To Prevent Fire or Hazards:

- Always turn the monitor OFF if you leave the room for more than a short period of time. Never leave the monitor ON when leaving the house.
- Keep children from dropping or pushing objects into the monitor's cabinet openings. Some internal parts carry hazardous voltages.

- 
- Do not add accessories that have not been designed for this monitor.
  - During a lightning storm or when the monitor is to be left unattended for an extended period of time, unplug it from the wall outlet.
  - Do not bring magnetic devices such as magnets or motors near the picture tube.
- 

### **On Installation**

---

Do not allow anything to rest upon or roll over the power cord, and do not place the monitor where the power cord is subject to damage.

---

Do not use this monitor near water such as near a bathtub, washbowl, kitchen sink, laundry tub, in a wet basement, or near a swimming pool.

---

Monitors are provided with ventilation openings in the cabinet to allow the release of heat generated during operation. If these openings are blocked, built-up heat can cause failures which may result in a fire hazard. Therefore, NEVER:

- Block the bottom ventilation slots by placing the monitor on a bed, sofa, rug, etc.
  - Place the monitor in a built-in enclosure unless proper ventilation is provided.
  - Cover the openings with cloth or other material.
  - Place the monitor near or over a radiator or heat source.
- 

### **On Cleaning**

---

- Unplug the monitor before cleaning the face of the picture tube.
  - Use a slightly damp (not wet) cloth. Do not use an aerosol directly on the picture tube because overspray may cause electrical shock.
- 

### **On Repacking**

---

- Do not throw away the carton and packing materials. They make an ideal container in which to transport the unit. When shipping the unit to another location, repack it in its original material.
-



## Connecting the Monitor

---

### Connection to any IBM VGA PC compatible system

Figure 1 shows the signal cable connections from the monitor to the Video Graphics Array (VGA) port typical in an IBM PC or PC compatible. This also applies to any graphics video card for PC-CAD or workstation that has a 15 pin high density (3 row) D-Sub connector.

1. Power off both the monitor and PC.
2. Connect the 15 pin VGA connector of the supplied signal cable to the output VGA video connector on the PC and the matching input connector on the rear of the monitor. The connectors will mate only one way. If you cannot attach the cable easily, turn the connector upside down and try again. When mated, tighten the thumbscrews to secure the connection.
3. Power ON the PC, then the monitor.
4. If you see the **SELF DIAGNOSTICS** message, check the signal cable and connectors.
5. After using the system, power OFF the monitor, then the PC.

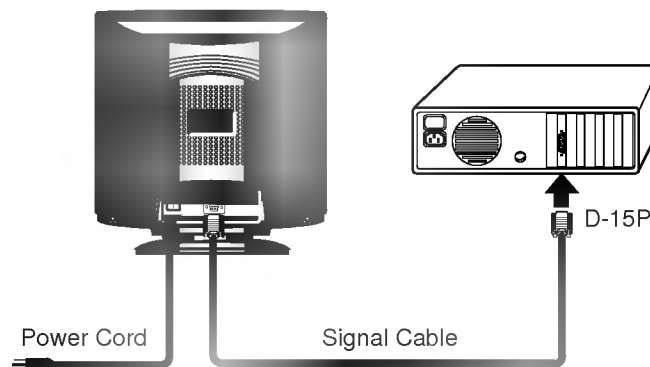

Figure 1.

---

## Connecting to an Apple Macintosh PC

Figure 2 shows the connection to an Apple Macintosh, using a separately purchased adapter.

1. Power OFF both the monitor and the PC.
2. Locate the appropriate MAC to VGA adapter block at your local computer store. This adapter changes the high density 3 row 15 pin VGA connector to the correct 15 pin 2 row connection to mate with your MAC. Attach the other end of the signal cable to the side of the adapter block with 3 rows.
3. Connect the attached adapter block/signal cable to the video output on your MAC.
4. Power ON the PC, then the monitor.
5. If you see the **SELF DIAGNOSTICS** message, check the signal cable and connectors.
6. After using the system, power OFF the monitor, then the PC.

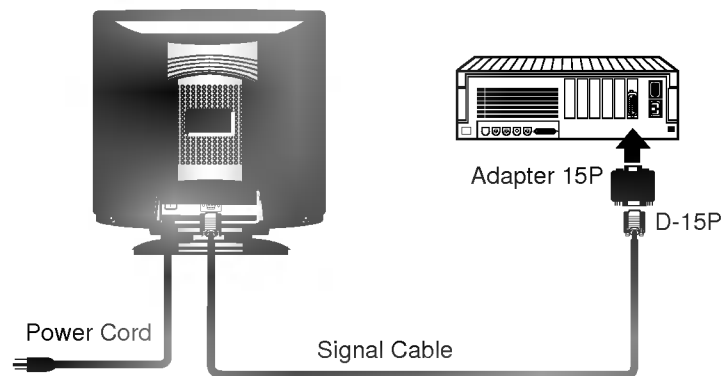
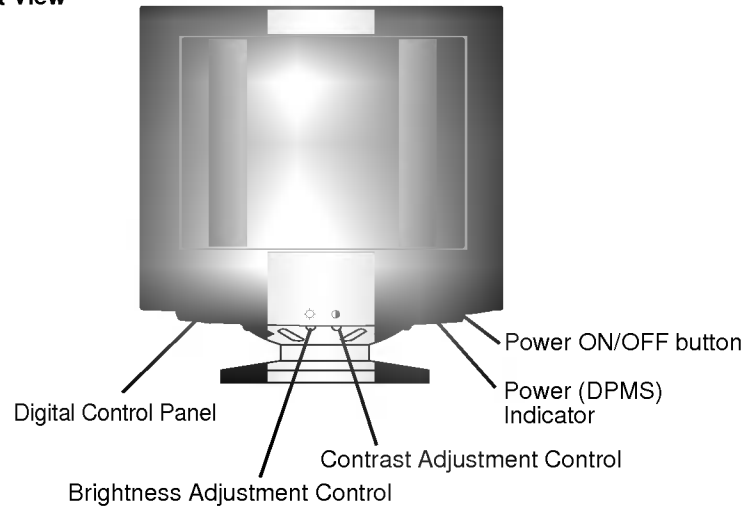

Figure 2.

## Location and Function of Controls

---

### Front View





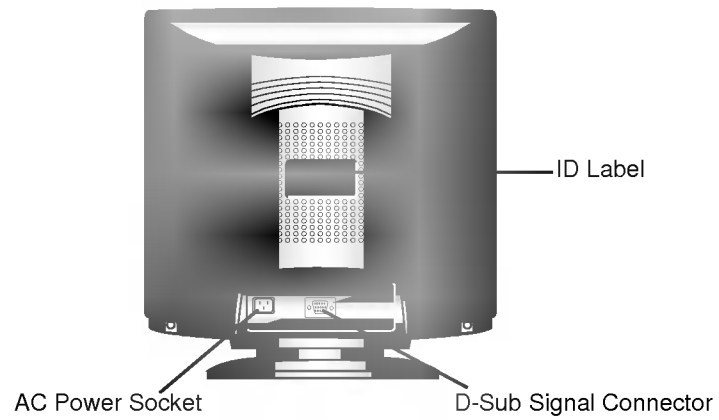



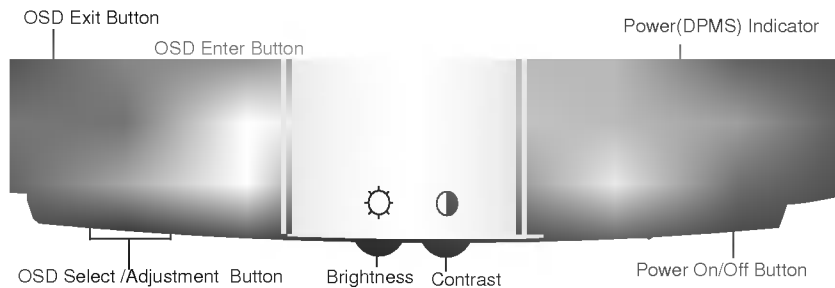

### Rear View



## Control Panel Function

### Front Panel Controls



Control	Function
 <b>OSD Enter Button</b>	Use this button to start/enter and exit from the On Screen Display (OSD). If there is no OSD on the screen, One click (press) of this button will show the Main Menu.
 <b>OSD Exit Button</b>	To disappear of the OSD on the screen.
 <b>OSD Select/ Adjustment Buttons</b>	Use these buttons for selecting (highlighting) an OSD icon to be adjusted. It is also used for selecting the level of the selected item to be adjusted.
 <b>Brightness Adjustment Control</b>	Used to adjust the brightness of the screen.
 <b>Contrast Adjustment Control</b>	Adjust the display to the contrast desired.
 <b>Power (DPMS) Indicator</b>	This indicator lights up green when the monitor operates normally. If the monitor is in DPM (Energy Saving) mode (stand-by/ suspend/off), this indicator color changes to amber.
 <b>Power ON/OFF Button</b>	Use this button to turn the monitor on or off.

## On Screen Display (OSD) Control Adjustment

Making adjustments to the image size, position and operating parameters of the monitor are quick and easy with the On Screen Display Control system, using only the Enter button and Adjustment Control buttons. A quick example is given below to familiarize you with the use of the controls. Following this section is an outline of the available adjustments and selections you can make using the OSD.



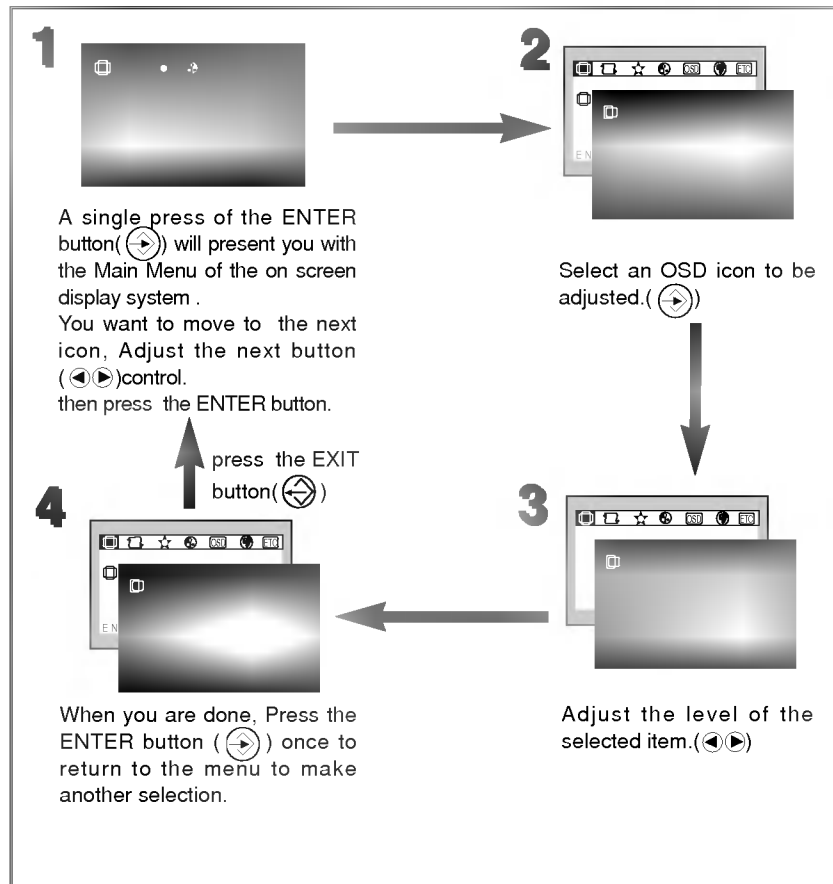





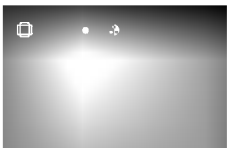

**Note :** Allow the monitor to stabilize for at least 30 minutes before making image adjustment.



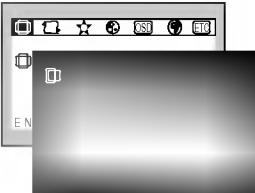



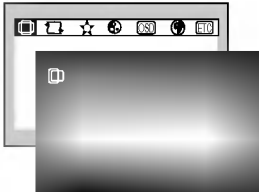





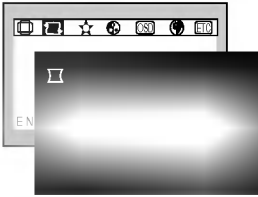

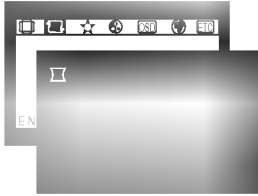

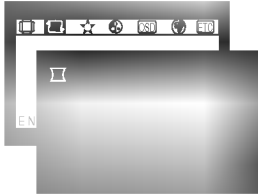

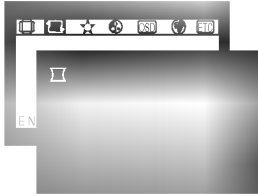
## On Screen Display(OSD) Selection and Adjustment

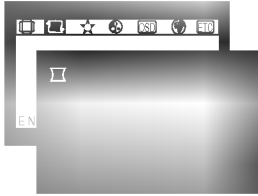
You were introduced to the procedure of selection and adjusting an item using the OSD system.

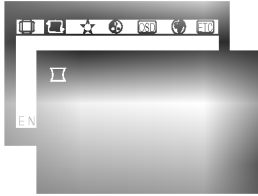
Listed below are the icons, icon names, and icon descriptions of the items that are shown on the Menu.

OSD Adjust	Description
	<p> <b>H Position (Horizontal Position)</b> To move picture image left and right.</p>
	<p> <b>H Size (Horizontal Size)</b> To adjust image width.</p>
	<p> <b>V Position (Vertical Position)</b> To move image up and down.</p>
	<p> <b>V Size (Vertical Size)</b> To adjust image height.</p>
	<p> <b>Zoom</b> To adjust horizontal and vertical image size simultaneously.</p>
	<p> <b>Tilt</b> To correct image rotation.</p>
	<p> <b>Recall</b> If the monitor is operating in a factory preset mode, this control will reset the image to the factory preset mode. If the monitor is operating in a user mode, this control has no effect.</p>

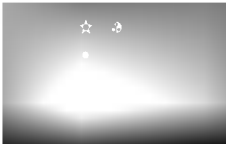
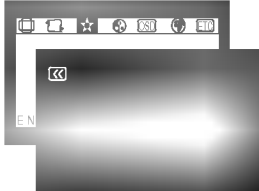
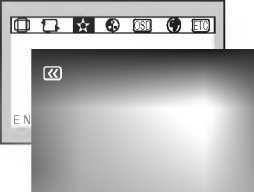
OSD Adjust	Description
	<p> <b>(side) Pincushion</b> To correct the bowing in and out of the image.</p>
	<p> <b>Trapezoid</b> To correct geometric distortion.</p>
	<p> <b>Pin balance (Side pincushion balance)</b> To correct the balance of both sides bowing.</p>
	<p> <b>Parallelogram</b> This control adjusts for a skewing of the screen image.</p>
	<p> <b>Top Corner</b> To correct the irregular distortion of the displayed image.</p>
	<p> <b>Bottom Corner</b> To correct the irregular distortion of the displayed image.</p>
	<p> <b>Recall</b> Select the <b>Recall</b> screen to reset Side Pincushion Balance, Parallelogram, Top Corner and Bottom Corner to their original factory preset settings. If the monitor is operating in a user mode, this control has no effect.</p>

OSD Adjust	Description
	<p><b>H Moire (Horizontal Moire)</b>  Reduce horizontal moire when interference patterns of dark steady wavy lines appear on your screen. The moire adjustments may affect the focus of the screen.</p>
	<p><b>V Moire (Vertical Moire)</b>  Reduce vertical moire when interference patterns of dark steady wavy lines appear on your screen. The moire adjustments may affect the focus of the screen.</p>
	<p><b>H Convergence (Horizontal Convergence)</b>  This item allows you to adjust the horizontal convergence. The horizontal convergence control adjust the alignment of the red and blue horizontal fields.</p>
	<p><b>Degauss</b>  Used to demagnetize the picture to give a more accurate image and color.</p>

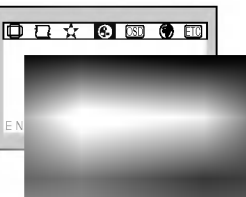

OSD Adjust	Description
	<p>9300 <b>9300K</b> To appear the display's color temperature. Slightly bluish white.</p>
	<p>6500 <b>6500K</b> To appear the display's color temperature. Slightly reddish white.</p> <hr/> <p><input checked="" type="checkbox"/> <b>User</b> To set your own color levels. Allow for specific adjustments to Red, Green and Blue (R/G/B).</p> <hr/> <p><input checked="" type="checkbox"/> <b>Color Temp (Temperature)</b> Temperature range is from 5000K to 10000K. So, user easily color set without adjustment Red, Green and Blue (R/G/B).</p>

---

OSD Adjust	Description
------------	-------------

---

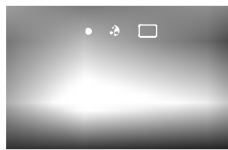

 **H Position (Horizontal Position)**  
This item lets you adjust the OSD horizontal position.

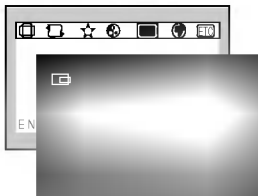

 **V Position (Vertical Position)**  
This item lets you adjust the OSD vertical position.

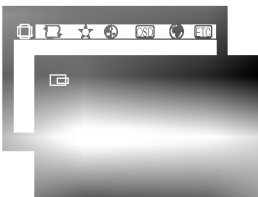



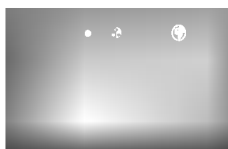

 **OSD Time**  
To control OSD display time from 5 second to 120 second.

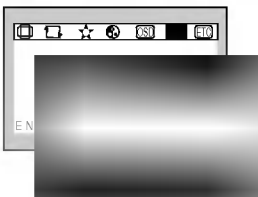

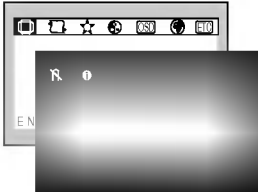
 **Language**  
To choose the language in which the control names are displayed. OSD Menus are available in 8 language: **English, Deutsch, Français, Español, Italiano, Svenska, Suomi and Português.**



OSD Adjust	Description
	<p><b>Degauss</b> Used to demagnetize the screen if minor color impurity occurs.</p>
	<p><b>Information</b> To inform users of preset and user mode data. This item provides information about the stored video modes.</p>
	<p><b>Video Level</b> To select input signal Level (0.7V or 1.0V).</p>
	<p><b>DDC (Display Data Channel)</b> To select the DDC plug and play function.</p>
	<p><b>CLAMP Clamp</b> In case of input SOG(Sync On Green) Video Signal, the background raster will appear the green. Then, to select the SOG(Sync On Green) in the clamp, will take you back to the original background raster.</p>

## Video Memory Modes

---

The monitor has 31 memory locations for display modes, 5 of which are factory preset to popular video modes.

### ■ Display Modes (Resolution)

Display Modes(Resolution)	Horizontal Freq.(kHz)	Vertical Freq.(Hz)
1 VESA 640 x 480	43.269	85
2 VESA 800 x 600	53.674	85
3 VESA 1024 x 768	68.677	85
4 VESA 1280 x 1024	91.146	85
5 VESA 1600 x 1200	93.750	75

---

### ■ User Modes

Modes 6-31 are empty and can accept new video data. If the monitor detects a new video mode that has not been present before or is not one of the preset modes, it stores the new mode automatically in one of the empty modes starting with mode 6.

If you use up the 26 blank modes and still have more new video modes, the monitor replaces the information in the user modes starting with mode 6.

### ■ Recalling Display Modes

When your monitor detects a mode it has seen before, it automatically recalls the image settings you may have made the last time you used that mode.

You may, however, manually force a recall of the factory default display settings of the each preset mode by pressing the Recall button. All preset modes are automatically recognized by the monitor as its microcontroller senses the incoming signal characteristics.

The ability to recall the preset modes is dependent on the signal coming from your PC's video card or system. If this signal does not match any of the factory modes, the monitor automatically sets itself to display the image.

## Energy Saving Design

This monitor complies with the EPA's Energy Star program, which is a program designed to have manufacturers of computer equipment build circuitry into their products to reduce power consumption during time of non-use.

This monitor also goes into its energy saving mode if you exceed the monitor's operating limits, such as the maximum resolution of 1600x1200 or the frequency refresh rates of 30-96kHz horizontal or 50-160Hz vertical. When this monitor is used with a Green or EPA Energy Star PC, or a PC with a screen blanking software following the VESA Display Power Management Signalling (DPMS) protocol, this monitor can conserve significant energy by reducing power consumption during periods of non-use. When the PC goes into the energy saving mode, the monitor will go into a suspended operation state, indicated by the Power LED light changing from a green color to an amber color. After an extended period in the suspended mode, the monitor will then enter a semi-OFF mode to conserve more energy. In the semi-OFF mode or DPMS OFF mode as we call it in our specifications, the Power LED will still show an amber color. When you awaken your PC by hitting a key or moving the mouse, the monitor will also awaken to its normal operating mode, indicated by the green Power LED light. By following these conventions, the power consumption can be reduced to the following levels:

### Power Consumption

	Hori.	Verti.		Power	
Normal(Max.)	On	On	Normal	≤ 130W	Green
Stand-by	Off	On	Off	≤ 8W	Amber
Suspend	On	Off	Off	≤ 8W	Amber
Off	Off	Off	Off	≤ 3W	Amber

## Low Radiation Compliance (MPR II)

---

This monitor meets one of the strictest guidelines available today for low radiation emissions, offering the user extra shielding and an antistatic screen coating. These guidelines, set forth by a government agency in Sweden, limit the amount of emission allowed in the Extremely Low Frequency (ELF) and Very Low Frequency (VLF) electromagnetic range.

## Self Diagnostics



This monitor can sense when there is a possible problem present, and informs you of this condition by presenting you with a **SELF DIAGNOSTICS** OSD. This OSD may pop up when it is On but no signal is detected. In this case the message **CHECK SIGNAL CABLE** will be high lighted, alerting you to check the signal cable connections.

## DDC (Display Data Channel)

DDC is a communication channel over which the monitor automatically informs the host system (PC) about its capabilities. This monitor has two DDC function; DDC1 and DDC2B. DDC1 and DDC2B carry out uni-directional communication between the PC and the monitor. Under these situations, the PC sends display data to the monitor but not commands to control the monitor settings.

**Note** : PC must support DDC functions to do this.

If your monitor is displaying a mono chrome image or the wrong resolution, select the DDC OFF function.

## Troubleshooting

---

### Self diagnostics message.

- The signal cable is not connected.
- 

### OUT OF FREQUENCY message appears.

- The frequency of the sync input is outside the operating range of the monitor.

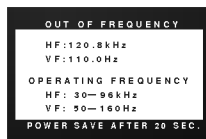

\*Horizontal Frequency: 30-96kHz

\*Vertical Frequency: 50-160Hz

Use the graphics board's utility software to change the frequency setting (Refer to the manual for graphics board).

---

### The power LED is illuminated amber.

- Display power management mode.
  - There is no sync signal.
  - The signal cable is not fastened securely.
  - Check the computer power and graphics adapter configuration.
- 

### The image on the SCREEN is not centered, or too small, or not a rectangle shape.

- Image adjustment not been done yet in the current operating mode. Use the SELECT and ◀ or ▶ buttons to set the image to your liking.
- 

### The monitor doesn't enter the power saving off mode (Amber).

- Computer video signal is not VESA DPMS standard. Either the PC or the video controller card is not using the VESA DPMS power management function.

**Note :** If the power indicator(LED) light is blinking amber, may result in abnormal condition of the monitor.

Then press a power ON/OFF button on the front panel control and call your service technician for more information.

---

## **Service**

---

Unplug the monitor from the wall outlet and refer servicing to qualified service personnel when :

- The power cord or plug is damaged or frayed.
- Liquid has been spilled into the monitor.
- The monitor has been exposed to rain or water.
- The monitor does not operate normally following the operating instructions. Adjust only those controls that are covered in the operating instructions. An improper adjustment of other controls may result in damage and often requires extensive work by a qualified technician to restore the monitor to normal operation.
- The monitor has been dropped or the cabinet has been damaged.
- The monitor exhibits a distinct change in performance.
- Snapping or popping from the monitor is continuous or frequent while the monitor is operating. It is normal for some monitors to make occasional sounds when being turned on or off, or when changing video modes.

---

Do not attempt to service the monitor yourself, as opening or removing covers may expose you to dangerous voltage or other hazards. Refer all servicing to qualified service personnel.

---



## Specifications

### Sync Signal Types

Type	H. Sync	V. Sync	Green
Separate Sync	H. Sync	V. Sync	-
Composite Sync	H/V Sync	-	N.C
Sync On Green	-	-	H/V Sync

(N.C : No Connection)

### Signal Connector Pin Assignment

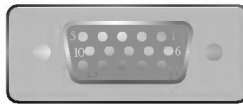

Pin	Signal (D-Sub)	Pin	Signal (D-Sub)
1	Red	9	NC
2	Green	10	Ground
3	Blue	11	Ground
4	Ground	12	SDA
5	Self-Test	13	Hori. Sync
6	Red Ground	14	Vert. Sync
7	Green Ground	15	SCL
8	Blue Ground		

**Note** :No. 5 Pin have to ground on the PC side.

## Specifications

---

### Picture tube

- 19 inches (18.0 inches viewable) FST, 90° deflection
- 0.26 mm dot pitch, Non-glare, Darkface
- Anti-Static, U-Coating

### Sync Input

- Horizontal Frequency : 30 - 96kHz (Automatic)
- Vertical Frequency : 50 - 160Hz (Automatic)
- Input Form : Separate, Composite, SOG(Sync On Green), Positive/Negative,
- Signal input : 15 pin D-Sub Connector

### Video Input

- Input Form : Separate, RGB Analog, 0.7 Vp-p/75 ohm, Positive
- Maximum Resolution : 1600 x 1200, 75Hz

### Power Input

- AC 100-240V 50/60Hz 2.0A

### Dimensions (with tilt/swivel stand)

- Width : 458 mm/18.0inches
- Depth : 479 mm/18.9 inches
- Height : 468 mm/18.4 inches

### Weight

- Net : 22.5kg (49.60lbs)

### Environment

- Operating condition
  - Temperature : 10°C to 35°C
  - Humidity : 10% to 90% non-condensing
- Storage condition
  - Temperature : 0°C to 60°C
  - Humidity : 5% to 90% non-condensing

Information in this document is subject to change without notice.