



Washing Machine

OWNER'S MANUAL

MODELS : WF-T5101(~5)PC(H/P), T5101(~5)PD(E/F)
WF-T5111(~5)PC(H/P), T5111(~5)PD(E/F)
WF-T5201(~7)PC(H/P), T5201(~7)PD(E/F)
WF-T5211(~7)PC(H/P), T5211(~7)PD(E/F)
WF-T6101(~5)TC(H/P), T6101(~5)TD(E/F)
WF-T6111(~5)TC(H/P), T6111(~5)TD(E/F)
WF-T6201(~7)TC(H/P), T6201(~7)TD(E/F)
WF-T6211(~7)TC(H/P), T6211(~7)TD(E/F)
WF-T5301(~7)TC(H/P), T5311(~7)TD(E/F)
WF-T5401(~5)TC(H/P), T5411(~5)TD(E/F)

Please read this manual carefully before operating your set.
Retain it for future reference.
Record model name and serial number of the set.
Quote this information to your dealer when you require service.

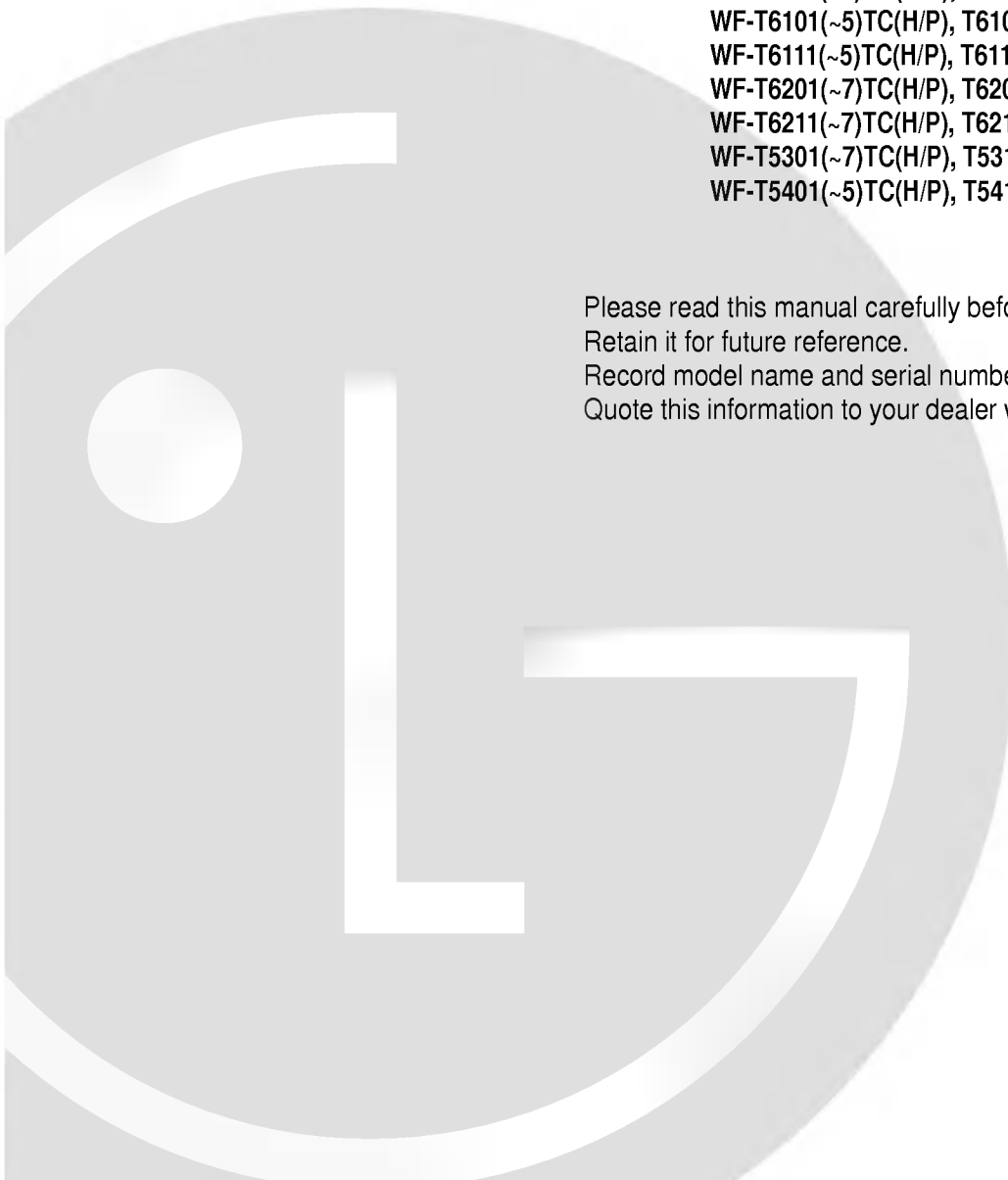

Product Features



The Turbo Drum washing machine does not operate with the lid open. If the lid is opened during wash, rinse and spin cycles, the machine will stop automatically.

Fuzzy Logic Control

- A built-in load sensor automatically detects and measures the laundry load and a microprocessor optimizes washing conditions such as ideal water level and washing time.
- Advanced technology is built into the Electronic Control System which ensures the best washing result.



Turbo Drum washing

- While the "Punch + 3" pulsator rotates in one direction, the Turbo Drum rotates in the opposite direction. This creates an even flow of water in both the upper and lower parts of the drum, resulting in an enhanced washing and rinsing action.



3 Step washing

- 3 sept washing makes best washing effect with low tangling.

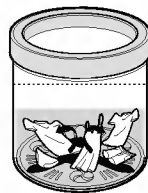

Rubbing

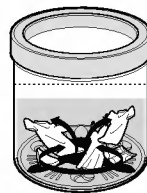

Rubbing and Shaking



Shaking and Disentangling

Lint Filter

- Lint and loose threads from laundry generated during the washing cycle are caught by the lint filter for a cleaner wash.



Auto Restart

- In the event of a power failure, the washing machine will automatically start its interrupted cycle when power is resumed.



※ Applied models : WF-T5101(~5)PD(E/F), T5111(~5)PD(E/F)
WF-T5201(~7)PD(E/F), T5211(~7)PD(E/F)
WF-T6101(~5)TD(E/F), T6111(~5)TD(E/F)
WF-T6201(~7)TD(E/F), T6211(~7)TD(E/F)
WF-T5301(~7)TD(E/F), T5311(~7)TD(E/F)
WF-T5401(~5)TD(E/F), T5411(~5)TD(E/F)

Read this manual

Inside you will find many helpful hints on how to use and maintain your washer properly. Just a little preventive care on your part can save you a great deal of time and money over the life of your washer. You will find many answers to common problems in the Troubleshooting section. If you review our chart of Troubleshooting Tips first, you may not need to call for service at all.

Introduction	Safety information	4
	Identification of Parts	5
Before Starting to Wash	Function Information	6
	Preparation Before Washing	7
	Use of Water, Detergent, Bleach and Softener	8
	Function of each Button	10
Washing Programs	Fuzzy Wash (Normal Wash)	12
	Economy Wash	12
	Jean Wash	12
	Wool Wash	12
	Soak Wash	12
Additional Function Options	Delay Start (Reservation) Wash	14
	Option Washing	15
	Other useful Functions	16
Installation	Placing and Leveling	17
	Connecting Water Supply Hose	18
	Connecting Drain Hose	21
Care and Maintenance	Grounding Method	22
	Cleaning	23
Specification	Specification	27

WARNING!

For your safety, the information in this manual must be followed to minimize the risk of fire or explosion, electric shock, or to prevent property damage, personal injury, or loss of life.

For your better understanding, these precautions are separated into two categories.

We urge you to pay special attention to them in the interests of your own safety, and protection of your machine against damage:

Violation of these guidelines could result in serious or fatal injury.

Following these guidelines will protect your machine against damage.

Installation	<ul style="list-style-type: none"> • The appliance is not intended for use by young children or infirm persons without supervision. • Do not install the washing machine in a damp place. • Keep the washing machine away from fire or heat source. • Young children should be supervised to ensure that they do not play with the appliance. • The base opening must not be obstructed by carpeting when the washing machine is installed on a carpeted floor. 	<ul style="list-style-type: none"> • Do not put your hands or feet under this machine. • Do not place any rugs or heavy material over the power cord. • Since the machine is heavy, a minimum of two persons should move it. • Do not install the washer where it is exposed to sunlight, wind, rain, etc. • The appliance must be positioned so that the plug is accessible
Power Supply cord	<ul style="list-style-type: none"> • Make sure to ground the earth wire or connect it to a ground detector after you put the power cord into an outlet. • When the power cord is loose, do not use it. • Do not damage the power cords. • Do not plug many cords into one outlet at the same time. • If the power cord or fuse is damaged, it must be replaced by the manufacturer or its service agents or similarly qualified people in order to avoid a hazard. • If the appliance is supplied from a cord extension set or electrical portable outlet device the cord extension set or electrical portable outlet device should be positioned so it is not subject to splashing or ingress of moisture. • Do not place any electric appliance with a charging battery, magnetically-driven appliance and magnetic body on the washer. 	<ul style="list-style-type: none"> • Make sure the power cord is free of dust and plug it in properly so that the cord will not move. • Do not touch the power cord with wet hands.
Operation	<ul style="list-style-type: none"> • When you take out the laundry, be careful not to fall into the washer. • Do not put hands into the rotating tub. • Do not sprinkle water over the buttons. • Make sure the lid is closed during operation of the spin cycle. 	<ul style="list-style-type: none"> • Do not press the buttons with sharp objects. • Check the hose connection and open the tap before activating the machine. • Do not pour more than 50°C(122°F) water into the tub. • Do not wash any waterproof materials.
Maintenance	<ul style="list-style-type: none"> • Do not put heavy objects on the machine. • Unplug the cord when the machine is not in use. 	<ul style="list-style-type: none"> • Do not pour corrosive materials or bleach over the washing machine. It will cause damage to the power cord or the machine. • Never disassemble or remodel the washer and power cord by yourself. Only a qualified technician should work on the machine.

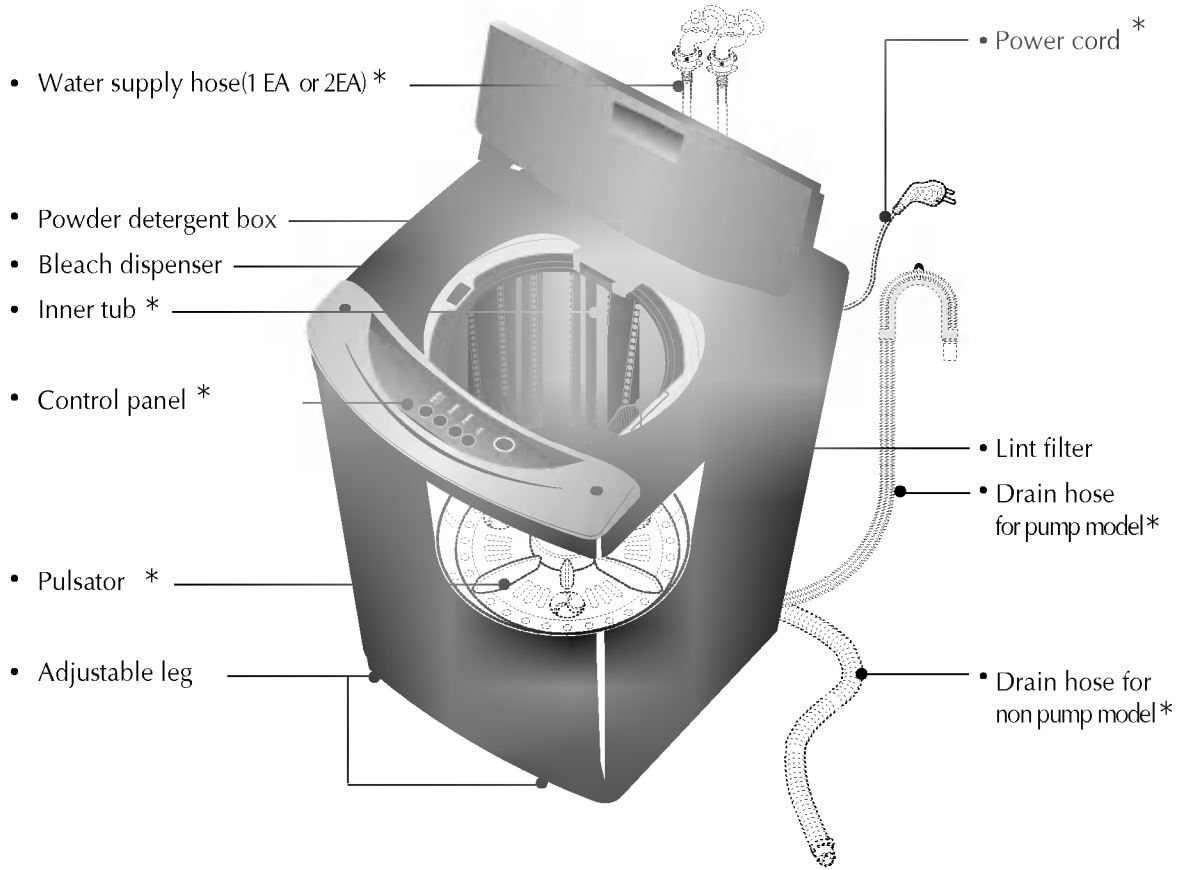

Water supply hoses

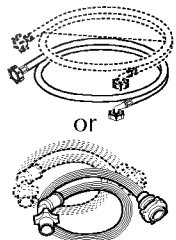

or

1 Each for cold and hot water

Drain hose

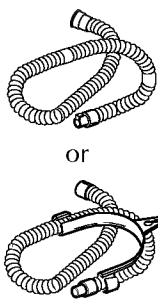

or

Anti-rat cover (option)

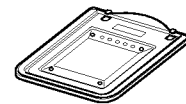

Note

“ ” Part can be different according to the model.

Our machine provides various washing methods which suit various conditions and types of laundry.

Different types of laundry washing

Fuzzy (Normal) Wash

Use this Program for normal clothes except for woolen clothes and lingerie. The sensor automatically detects the quantity of laundry and selects the appropriate water level, wash power, washing time, rinsing time and spinning time. (refer to p12)

Economy wash can be selected to wash lightly soiled clothes of less than 2.0 kg in a short time. (refer to p12)

Thick and heavy clothes or those which are excessively dirty like jeans or working uniforms can be washed. (refer to p12)

Delicate clothes (lingerie, wool etc.) which may be easily damaged can be washed. (refer to p12)

Soak Wash can be selected to wash heavily soiled laundry by soaking in water for some time to remove dirt and grime. (refer to p12)

Other washing methods

Delay Start (Reservation) Wash

Delay Start (Reservation) Wash is used to delay the **finishing time** of the operation. Delayed Start washing can be set according to preference. (refer to p14)

Spin, Rinse/Spin, Rinse, Wash/Rinse, and Wash only options can selected. (refer to p15)

Preparation Before Washing

To get the best results, different fabrics need to be washed in different ways.

SOIL (Heavy, Normal, Light) Separate clothes according to amount of soil
COLOR (Whites, Lights, Darks) Separate white fabrics from colored fabrics.
LINT (Lint producers, Collectors) Separate lint producers and lint collectors.

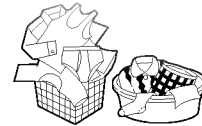

- **Check all pockets to make sure that they are empty.** Things such as nails, hairclips, matches, pens, coins and keys can damage both your washer and your clothes.
- **Close zippers, hook and strings** to make sure that these items don't snag on other clothes.
- **Mend any torn garments or loose buttons.** Tears or holes may become larger during washing.
- Remove any **loose brassiere wires** as they can damage your washing machine and clothes.
- **Pre-treat dirt and stains.**
- Make sure the clothes are washable in water.
- Check the washing instructions.

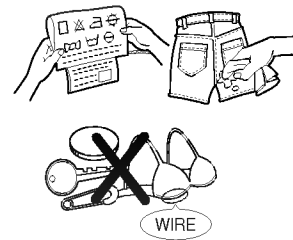

Brush a little detergent dissolved in water onto stains like collars and cuffs to help shift dirt.
 Treat stains **AS SOON AS POSSIBLE**. The longer they are left the harder they are to remove.



Light and Large-size clothing

Clothes like downs and woollens are light weight, large and float easily. So use a nylon net and wash them in a small amount of water. If the laundry floats during the wash cycle, it may become damaged. Use dissolved detergent to prevent the detergent from clumping.

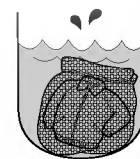

Use nylon nets for long, delicate items.
 For laundry with long strings or long length, a net will prevent tangling during washing.
 Fasten zippers or hooks on items before washing.
 ※ Nylon net is not supplied by LG.

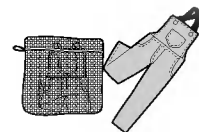

Using water

- This machine detects the quantity of laundry automatically, then sets the water level and proper amount of detergent.
- When you select a wash program, the water level and amount of detergent (to be used) will be shown on the control panel.



- When the water level is automatically detected, it may differ depending on the quantity of laundry even though the same water level is indicated on the control panel.

Water temperature

- The machine sets the appropriate temperature automatically according to the wash program .
- You can change the water temperature by pressing the WATER TEMP button. (refer to p10)

Using Detergent and Fabric Softener

- When you select a wash program, the water level and the amount of detergent will be shown on the control panel. The amount of a cup in the diagram is about 40g for concentrated detergent.
- For the correct amount of detergent, refer to detergent manufacturer's instruction .

Available Detergent Type

- Synthetic detergents that yield a low level of foam are recommended.
- When liquid detergent is used, mix it with water (1:1) and pour it into the bleach dispenser.



If excessive detergent is used, the rinse will not be as clean and efficient. Also, it could cause environmental pollution, so use it accordingly.

- Do not use concentrated fabric softener. This may cause some problems in automatic dispensing.
- For more details refer to the softener products instructions for use.

- Open the detergent dispenser and deposit the appropriate amount of detergent .

Powder Detergent dispenser.

Where you deposit the detergent

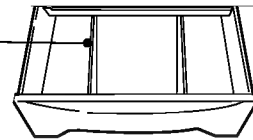

- ! Don't use softener with detergent. Use softener in last rinse water
- When using dispenser, dilute softener(30ml) with fresh water(30ml)
- When filling dispenser, do not splash or overfill. It may stain clothes.
- Never pour fabric softener directly on clothes. It may stain them
- If spotting occurs, wet and rub hand dishwashing liquid (or mild bar soap) and rewash.

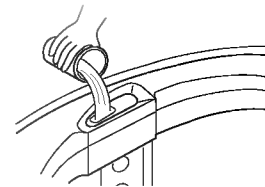

Fabric Softener will be inserted automatically during the final rinse.

Using Bleach

Check fabric care labels for special instructions.

- Use oxygenated bleach.
- Powdered bleach should mixed with water and then be deposited into the tub.
- For more details refer to the products instruction for use.

- Separate the laundry to be bleached and deposit liquid bleach into the Bleach dispenser. The dispenser dilutes liquid chlorine bleach before it reaches into your wash load.

Bleach dispenser

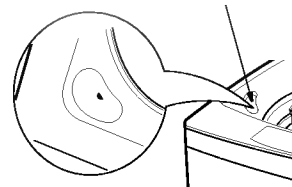

Attention

- Do not insert bleach or fabric softener directly onto laundry. This may affect colors or damage clothing
- Do not mix chlorine bleach with ammonia or acids such as vinegar and/or rust remover. Mixing can produce a toxic gas which may cause death.

- Use to select water temperature. Pressing the button allows you to select Cold ► Warm (Hot&Cold) ► Hot ► Cold respectively. Default setting is Cold.

- Use to adjust the water level as required. The appropriate amount of detergent is shown next to the water level in the WATER-DETERGENT diagram
- Water level is automatically selected for fuzzy (normal) and jean programs. The following settings are indicated as the button is pushed LARGE ► EX-LARGE ► SMALL ► MEDIUM ► LARGE

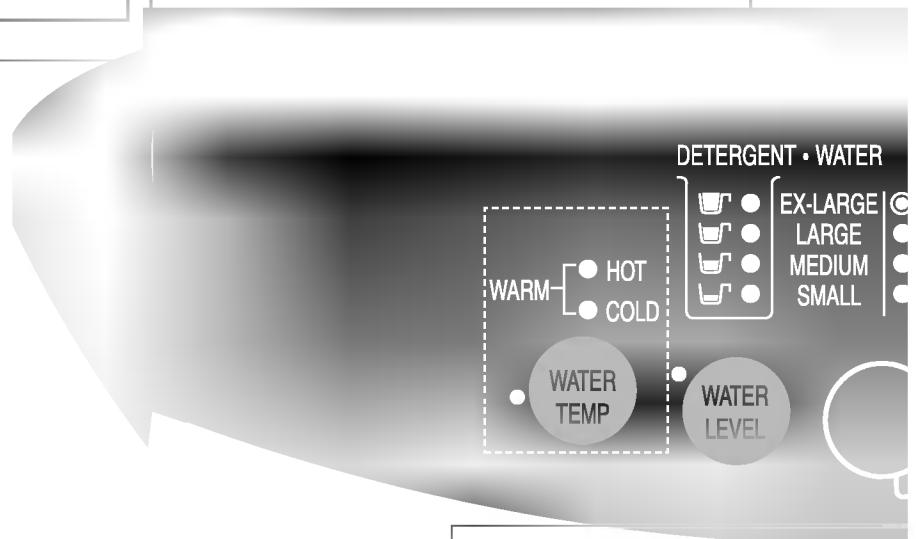

- Use to select SOAK, WASH, RINSE and SPIN functions as desired.





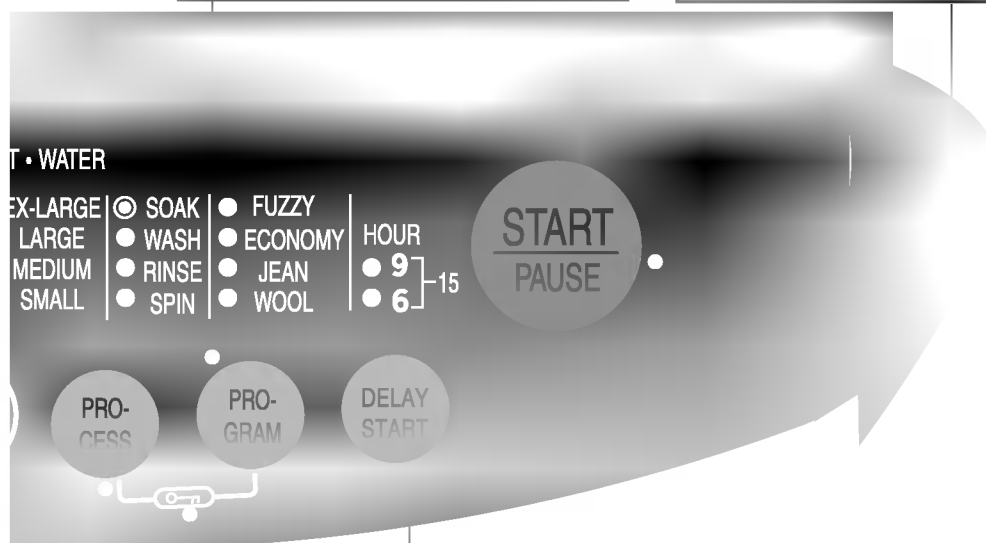













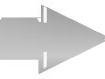

- Use for selecting wash program.
- This button allows you to select 4 different programs for different kinds of laundry and dirtiness.
- program selections light up in sequence as follows: FUZZY (NORMAL) ► ECONOMY ► JEAN ► WOOL ► FUZZY (NORMAL) etc. Select the desired program by pressing the button.



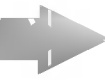
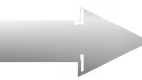













- Use to start or pause the washing process.
- Repeats start and pause by pushing the button.
- The power goes off automatically 10 minutes after stopping.
- ※ This appliance is fitted with a safety function that automatically stops the operation of the washing machine when it is exposed to heavy disturbance on the mains.



Use to lock or unlock the control buttons to prevent setting from being changed by a child.
To lock, push the PROCESS, and PROGRAM buttons simultaneously and to unlock push them one more time during the washing process.
(refer to p 16)

• Use to set a delayed finishing time.
The time changes 6→9→15(6+9)→6hr when the button is pushed.
(refer to p14)

Washing Programs		Add the laundry			Add the detergent	
<p>Fuzzy Washing (Normal Wash)</p> <p>Used for normal loads, this mode automatically selects the most appropriate conditions and completes the sequence in one operation. The built-in sensor detects the size of the load and the ideal wash power and wash, rinse and spin times are set accordingly</p>					 <ul style="list-style-type: none"> • Add the appropriate quantity of detergent as indicated by the water level next to WATER-DETERGENT. Or follow the detergent manufacturer's instructions 	
<p>Economy Wash</p> <p>Use this mode when washing lightly solided clothes for a short time. The weight should be under 2.0kg.</p>			 <ul style="list-style-type: none"> • Select the ECONOMY program on the Control panel. 			
<p>Jean Wash</p> <p>Use jeans program when washing heavy, thick, and extremely dirty laundry such as jeans and work outfits.</p>			 <ul style="list-style-type: none"> • Select the JEAN program on the Control panel. 			
<p>Wool Wash</p> <p>Use this program for washing delicate fabrics such as lingerie and woolens. (wash only "water washable" clothes) Before washing your woolens check the care label for the washing instructions. (wash only water washable clothes)</p>			 <ul style="list-style-type: none"> • Select the WOOL program on the Control panel. 		 <ul style="list-style-type: none"> • Use neutral detergent appropriate for the laundry. • When washing woolens use a mild detergent recommended for washing wool. 	
<p>Soak Wash</p> <p>Use this mode for washing excessively dirty laundry by soaking in water for some time to remove proteins and fats. 'SOAK' mode can be used with all washing programs simultaneously except for "WOOL" program.</p>			 <ul style="list-style-type: none"> • The SOAK will not work in WOOL Program. 			<p>• Keep pressing the PROCESS button until the SOAK light is on and then WASH, RINSE, SPIN lights are on simultaneously.</p> <p>• If necessary, select the desired washing process from (SOAK+WASH+RINSE+SPIN), (SOAK+WASH+RINSE), (SOAK+WASH) manually.</p> <div data-bbox="1240 1667 1333 1745" style="border: 1px solid black; padding: 2px;"> <ul style="list-style-type: none"> ● SOAK ● WASH ● RINSE ● SPIN </div>

	Close the lid	Finish	Caution & Note
 <ul style="list-style-type: none"> • The pulsator rotates for 8 seconds to detect the laundry load. • Then the water level and the amount of detergent to be used will be shown and water will be supplied. 	 <ul style="list-style-type: none"> • Water will be supplied for 2 minutes after the start of the wash to supplement the water the laundry has absorbed. 	 <ul style="list-style-type: none"> • When the wash program ends, the buzzer will ring for 10 seconds before the Power goes off automatically. 	<ul style="list-style-type: none"> • If water is already in the tub, or putting wet laundry into the tub before starting will increase the water level. • With lightweight bulky loads, water level can be set low. • Changes to water temperature (hot/cold) and wash level are possible during operation. (refer to p 10)
			
			
 <p>gent ie</p> <p>ild mend- ool.</p>			<ul style="list-style-type: none"> • When setting the water level manually, do not set to MEDIUM to prevent damage to laundry. • Washing with hot water may damage the laundry (Water is set to cold automatically). Ensure that the load is under 2kg • In order to avoid damage to laundry, the spin cycle may appear slow. This also avoids wrinkles and clothing may still contain some water. This is normal. • Soak Wash cannot be selected for the Wool Wash program.
 <ul style="list-style-type: none"> • The water level and the amount of detergent to be used will be shown and water will be supplied. 			

Delay Start (Reservation) Wash

Delay Start (Reservation) Wash is used to delay the finishing time of the operation. The hours to be delayed can be set by the user accordingly. The time on the display is the finishing time, not the start time.

Press the **POWER** button to turn power on.



Press the **PROGRAM** button to select the washing program.



- Select the program for laundry on the Control panel. This method will not work in Wool Program.

Press the **Delay Start (RESERVATION)** button to set the time when the delayed washing is to be completed.



- The time changes as following order (6→9→15→6Hours).

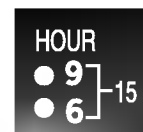

Add the detergent.

- The appropriate quantity of detergent marked next to the water level of WATER-DETERGENT.
- When the lid is open the machine will not operate, and an alarm signal will remind you to close the lid

Add the laundry and press the **START/PAUSE** button.



- When you press the START/PAUSE button the light will blink.

Close the lid.

- Water will be supplied for 2 minutes after the start of the wash to supplement the water the laundry has absorbed.

Finish

The washing will be finished according to the delayed time.

- If the lid is open, the machine will not work, and an alarm signal will alarm to remind you to close the lid.
- To select washing program, spinning time, water level or hot/cold manually, press the Delay Start (RESERVATION) button and select the desired option. Then press the START/PAUSE button.
- When the laundry cannot be taken out immediately after the wash program ends, it is better to omit the spinning program. (The laundry will be wrinkled if left for a long time after spinning.)

When you only need the Wash, Wash/Rinse or Rinse cycles, these can be set manually

Press the **AUTO OFF** (Power) button to turn power on.



- Press the **PROCESS** button until above Option Washing light is on. (refer to p11)
- When you want to only drain, wait until the water in the washing tub drains completely and then, turn off the power.

Press the **WATER LEVEL** button, to control the water level according to the amount of laundry. If you do not choose anything, it is set the **LARGE** water level automatically. (refer to p10)



Add the laundry into the washing tub.

Press the **START/PAUSE** button.



Add the detergent and close the lid.

- When a **Wash, Wash/Rinse** or **Rinse** only option is selected, after the wash is completed the water will not be drained off, If you wish to drain the water, press the **SPIN** button and wait until the water in the tub has drained completely. Then press the **START/PAUSE** button .
- **If you do not specify the water level**, then Medium will be automatically selected.
- If only Rinse is selected, the process will start from Water Supply.

Child Lock Function

If you want to lock all the keys to prevent all the setting from being changed by a child, you can use the child lock option.

Press the **POWER** button.



- Turn Power on.

Press the **START/PAUSE** button to start washing.



- After all washing conditions are set according to the manual.

Press both the **PROCESS** button and the **PROGRAM** button simultaneously.

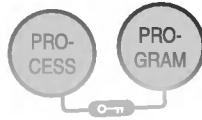

- During the wash program, all the buttons are locked until washing is completed or it is child-lock function is deactivated manually.

If you want to unlock during wash, press both the **PROCESS** and the **PROGRAM** button simultaneously again.

Note

- In child-Lock mode, all process light will blink.

Mute Option

If you want to use the washing machine without alarm signal sounds, press both the **WATER LEVEL** and **PROCESS** buttons simultaneously.

To make buzzer work, press both the **WATER LEVEL** and **PROCESS** buttons simultaneously one more time.

Place the machine on a flat and firm surface which allows proper clearance.

We suggest a minimum clearance of 2cm right side and left sides of the machine for ease of installation.

At the rear, a minimum clearance of 10cm is suggested.

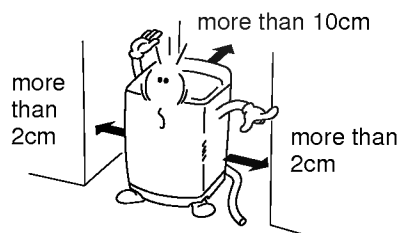

Check that the machine is level

Open the lid and look from above to see if it is same as shown.

Top view of the machine

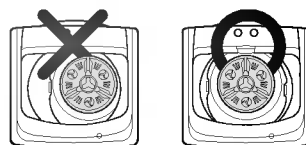

Leveling the machine

Lift the front of the washing machine and twist the Adjustable Leg until the washing machine is placed evenly.

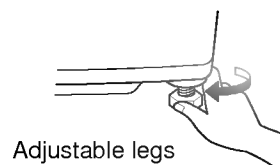

※ Installing the Anti-Rat Cover (option)
The anti-rat cover should be affixed firmly from the back of the washer

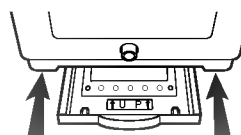

If the power is supplied from a cord extension set or generator, the cord extension set or electrical portable outlet device should be positioned so that it is not exposed to splashing or ingress of moisture.

Connecting Water Supply Hose

Before connecting the Water Supply Hose to the water tap, check the hose type and then choose the correct instruction here under.

Note that the Water Supply Hose supplied may vary from country to country, Make sure to connect the blue inlet hose to the cold water tap, and the orange inlet hose to the hot water tap

Connecting Water Supply Hose to water tap

 (Normal tap without thread & screw type inlet hose.)

Untighten the screw

Untighten the screw of the connector so that the tap can be placed in the middle.

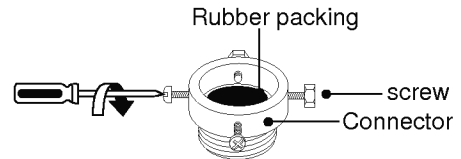

Fixing the connector to the tap

Push the upper connector up till the rubber packing is in tight contact with the tap. Then tighten the 4 screws.

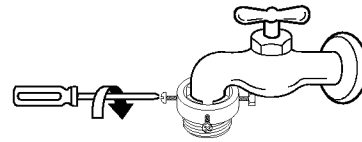

Attach the water supply hose connects securely to the connector

Push the water supply hose vertically upwards so that the rubber seal within the hose can adhere completely to the tap.

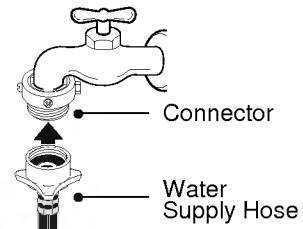

Fixing the connector of connector and water supply hose

Attach the water supply hose to the connector and then tighten it by screwing it to the right.

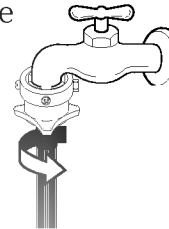

Check the connection of water supply hose and the connector

After connecting the hose, open the tap to check for any water leakage.

In case of water leakage, close the tap and start again from step 1

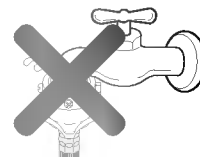

(Normal tap without thread & one touch type inlet hose.)

Separate Middle connector from Water Supply Hose

Separate Middle connector from the Water Supply Hose by pulling the Pressing Rod and the Pressing Handle that is attached to the Water Supply Hose while pressing them.

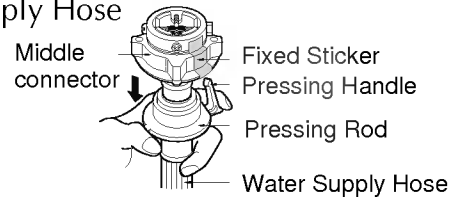

Loosen the fixed nuts to connect the connector to the tap

Untighten the screw of the connector so that the tap can be placed in the middle.

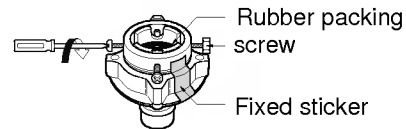

In case the tap is too large.

If the tap diameter is too large or is square, untighten the 4 screws and remove the guide plate. Then follow step 1.

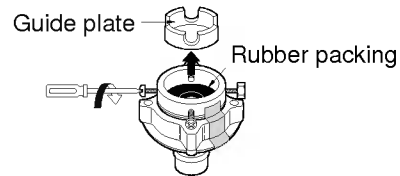

Fixing Connectors to the Tap

Push the upper connector up till the rubber packing is in tight contact with the tap. Then tighten the 4 screws.

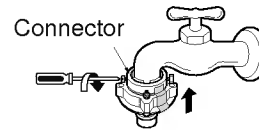

Fixing Upper Connector and Middle Connector

Remove the fixed sticker in between the Upper and Middle Connectors. Tighten the connectors by holding one connector and twist middle connector to the right.

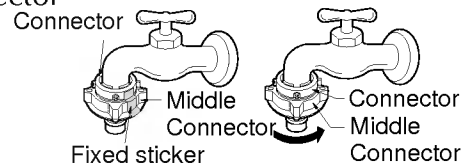

Connecting Middle Connector and Water Supply Hose

Press down the pressing rod of the Water Supply Hose which was separated from middle connector (refer to Step 1) and then join it to the middle connector.

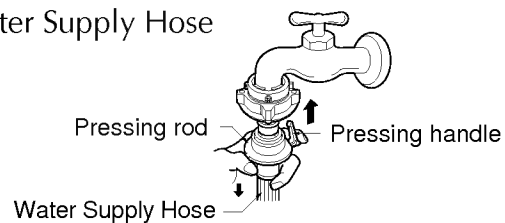

Check for water leakage

After connecting the hose, open the tap to check for any water leakage.

If the connection leaks, close the tap and start again from step 1.

If you skip step 1, water leakage may occur.



Connecting Water Supply Hose

Attach the water supply hose to the tap.

Push the water supply hose up so that the rubber packing within the hose can adhere completely to the tap.

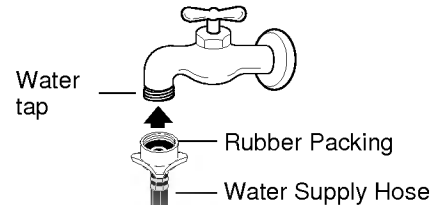

Connect the water supply hose to the tap.

Connect the water supply hose to the tap and then tighten it by screwing it to the right.

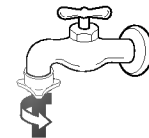

Check water leakage.

After connecting the hose, open the tap to check for any water leakage.



Connecting Water Supply Hose to the machine

Connect the water supply hose to inlet valve of the washing machine, and then lock it by turning the hose connecting part.

Check to see if there is a rubber seal inside the connector.

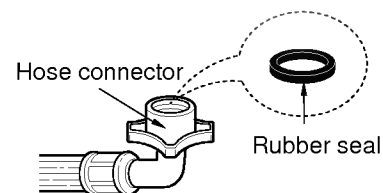

Before connecting Drain Hose, check your Drain Hose model and choose the correct instructions.

Fit the machine end of the drain hose to the outlet of the drain pump and tighten the clamp.

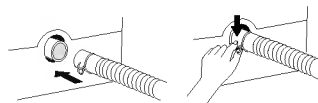

Put the other end of the drain hose over the standpipe or wash tub.

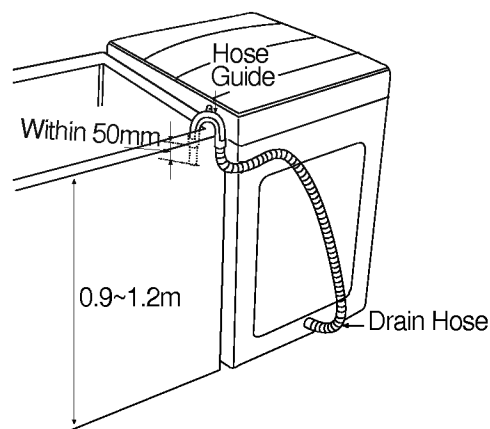

Note

- To prevent siphoning, the drain hose should not extend more than 50mm from the end of the hose guide.
- The discharge height should be approximately 0.9 ~ 1.2m from the floor.

Before connecting

Ensure that the hose clip is set as indicated here.

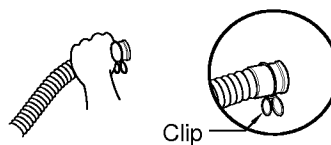

Connect the Elbow Hose

Push the elbow hose toward the body of the washing machine.



Place the Drain Hose

To change the direction of the hose, pull out the elbow hose and change the direction. Repeat Step2.

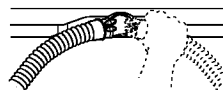

Earth wire should be connected.
If the earth wire is not connected, there is possible a danger of electric shock caused by the current leakage.

Grounding Method with Ground insert space Terminal

If the AC current outlet has a ground terminal, then separate grounding is not required. Note that AC power outlet configurations may differ from country to country

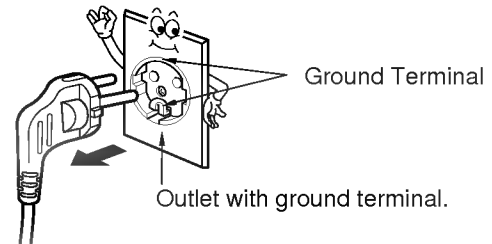

Other Grounding Method

Connect the Ground Wire to a Ground Copper Plate and bury it more than 75cm in the ground.

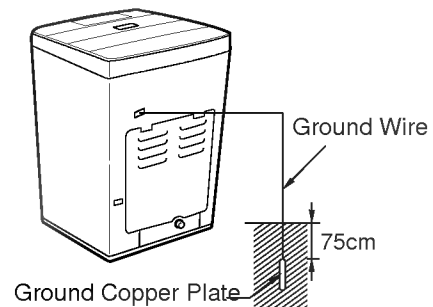

Connect the ground Wire to the socket provided exclusively for Grounding.

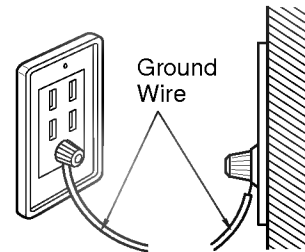

Using Short Circuit Breaker

If grounding methods described above are not possible, a separate circuit breaker should be employed and installed by a qualified electrician

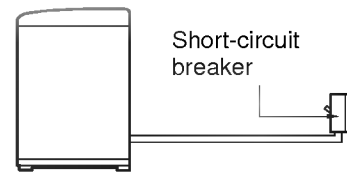

- To prevent a possible explosion, do not connect ground to a gas pipe
- Do not connect ground to telephone wires or lightning rods. This may be dangerous during electrical storms
- Connecting ground to plastic has no effect
- Ground wires should be connected when an extension cord is used.

When water supply into the tub is not clean or the filter is clogged with particles (Such as sand), clean the filter in the inlet valve occasionally. (The figure of power cord and water tap may vary according to the country)

To Clean the Filter in the Inlet Valve

Close the tap before turning off the power.
Select both hot/cold and then press the [START/PAUSE] button to remove water from the machine completely.

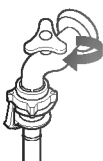

Turn off the power before pulling out the cord.

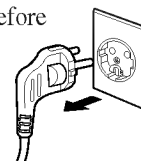

After removing the water supply hose pull out the filter. Then use a brush to clean the filter.

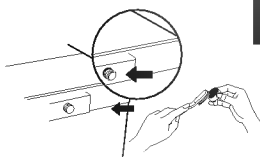

Replace the filter after cleaning it.

To Clean the Lint Filter

Pull out the lint filter from the tub in the direction shown below.



Turn the net inside out to clean the filter and rinse it with water.

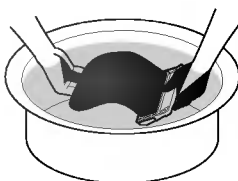

Replace the filter to the original location. Push the lip of the filter until a pop sound is heard.



Note

- If the lint filter is torn or damaged, purchase a new one from LG service center.

To Clean the Pump casing (for pump model)

Unfasten 4 screws of the back cover.

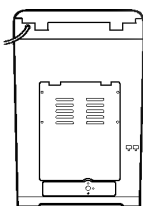

Turn the cap as shown in diagram and unfasten it. Remove foreign objects such as pin, button, coin, etc

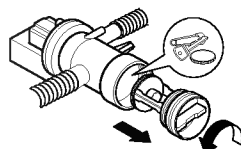

(Bottom view)

Reassemble the cap to the arrow direction and fasten it.

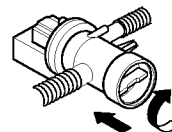

(Bottom view)

- Check if water leaks after reassembling. (The Rubber ring is in the cap)

WHEN THERE IS A FEAR OF FREEZING

Close the water taps and remove the Water Supply Hose.

Remove the water which remains in the water supply.

Lower the drain hose and drain the water in the bowl and the drain hose by spinning.

IF FROZEN

Remove the water supply hose, and immerse it in hot water at approx.. 40 °C.

Pour approx.. 2 liters of hot water at approx.. 40 °C, into the bowl and let it stand for 10 minutes.

Connect the water supply hose to the water tap and confirm that the washing machine performs the supply and drainage of water.

- | | |
|-----------------------|---|
| Wash Inner-tub | Leave the lid open after washing to allow moisture to evaporate. If you want to clean the inner-tub use a clean soft cloth dampened with liquid detergent, then rinse. (Do not use harsh or gritty cleaners.) |
| Inlet Hoses | Hoses connecting washer to faucet should be replaced every 5 years. |
| Exterior | Immediately wipe off any spills. Wipe with damp cloth. Try not to hit surface with sharp objects. |
| Long Vacations | Be sure water supply is shut off at faucets. Drain all water from hoses if weather will be below freezing. |

SCRUD

Scrud is the name given to the waxy build-up that can occur within any washer when the fabric softener comes into contact with detergent. This build-up is not brought about by a fault in the machine.

If scrud is allowed to build-up in the machine it can result in stains on your clothes or an unpleasant smell in your washer.

If you wish to use fabric softener we recommend.

- Using fabric the dispenser, do not splash or overfill.
- Clean dispenser as soon as the cycle has finished.
- Clean your machine regularly
- Cold water washing increases the chance of this build-up occurring. We recommend a warm or hot wash at regular intervals e.g. approx. every 5th wash.
- Fabric softener of thinner consistency is less likely to leave residue on the dispenser and contribute to a build-up

CLEANING THE INSIDE OF YOUR WASHER





- Fill your machine with hot water. Add about two cups of a powder detergent that contains phosphate.
- Let it rotate for several minutes.
- Stop the machine, drain the machine and run the machine through a regular cycle.
We do not recommend that you wash clothes during this procedure.

Look for your problem below, then check the things we suggest. More often than not, this will give you the answer to your problem. And you'll be able to carry on without having to telephone your service center.

WASH PROBLEM

Problem	Possible Causes	What To Do
Lint or residue on clothes	Incorrect sorting Washing too long	<ul style="list-style-type: none"> • Separate lint producers from lint collectors. • Wash small loads for a shorter time than larger loads.
Detergent on clothes	Detergent not dissolving	<ul style="list-style-type: none"> • Try using less detergent • Use warmer water temperature. • Try a liquid detergent. • Try pre-dissolving the detergent
Black spots on clothes	Incorrect use of fabric softener Dye transfer	<ul style="list-style-type: none"> • When filling dispenser, do not splash or overfill. • Never pour fabric softener directly on clothes. • Pre-treat stain and rewash. • Sort whites or lightly colored items from dark colors. • Wash and dry non-colorfast clothes separately
Snags, holes, tears, rips or excessive wear	Pins, snaps, hooks, sharp buttons, belt buckles, zippers, and sharp objects left in pockets Undiluted chlorine bleach	<ul style="list-style-type: none"> • Fasten snaps, hooks, buttons, and zippers. • Remove any loose brassiere wires. • Remove objects in pockets and sharp buttons. • Turn knits (which snag easily) inside out. • Check bleach package instructions for proper amount. • Never add undiluted bleach to wash or allow clothes to come in contact with undiluted bleach.
The laundry comes out dirty	Water temperature is too cold. Stain is not pre-treated Washer is overloaded Incorrect sorting	<p>Use warmer water temperature</p> <p>Brush a little detergent dissolved in water onto stains like collars and cuffs to help shift dirt. Wash stains as soon as possible. The longer they are left the harder they are to remove.</p> <p>Did you load too much into the machine?</p> <p>White clothes are better washed separately. Separate light and heavily soiled items.</p>

Before calling for service check the problem against the list belows.

Symptom	Error Message	Check up
Water Supply Failure		<ul style="list-style-type: none"> • Is the water tap shut off? • Is the water supply cut off ? • Is the tap or water supply hose frozen ? • Is the water pressure low or is the filter of the inlet valve clogged with impurities? • Is Hot/Cold selected to Hot when the hose connected is Cold? • Is the Cold hose connected to Hot?
Drainage Failure		<ul style="list-style-type: none"> • Is the drain hose positioned correctly? • Is the drain hose bent or placed too high? • Is the internal part of the hose or drain pump (only pump model) clogged with impurities? • Check if electric power has gone off.
Spin Failure		<ul style="list-style-type: none"> • Is the laundry evenly balanced? • Is the washing machine placed on a flat surface?
Door(Lid) Open		<ul style="list-style-type: none"> • Is the lid closed?
Internal sensing failure		<ul style="list-style-type: none"> • Ask for help at the LG Electronic branch of the Service Center
Power failure		
Overflow failure		

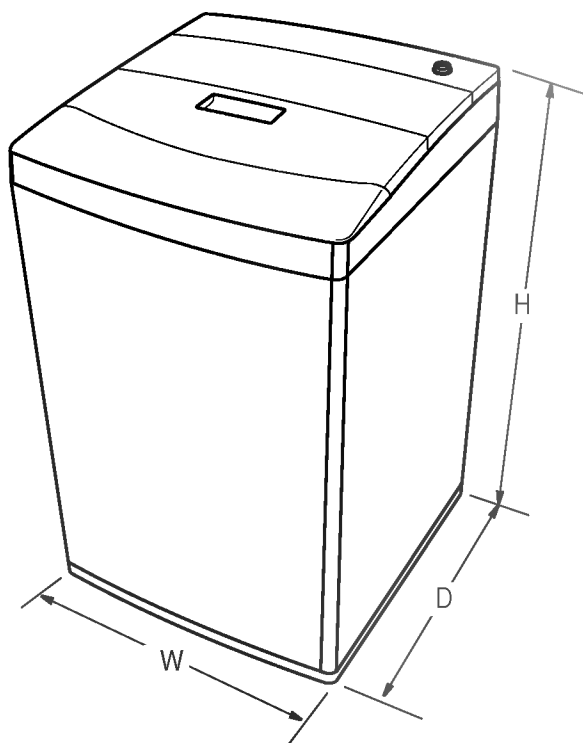

WF-T5101(~5)PC(H/P), T5101(~5)PD(E/F), T5111(~5)PC(H/P), T5111(~5)PD(E/F)

WF-T5201(~7)PC(H/P), T5201(~7)PD(E/F), T5211(~7)PC(H/P), T5211(~7)PD(E/F)

WF-T6101(~5)TC(H/P), T6101(~5)TD(E/F), T6111(~5)TC(H/P), T6111(~5)TD(E/F)

WF-T6201(~7)TC(H/P), T6201(~7)TD(E/F), T6211(~7)TC(H/P), T6211(~7)TD(E/F)

WF-T5301(~7)TC(H/P), T5311(~7)TD(E/F), T5401(~5)TC(H/P), T5411(~5)TD(E/F)

WF-T5201(~7), T6201(~7), T5301(~7) : 530(W) x 540(D) x 850(H)

WF-T5211(~7), T6211(~7), T5311(~7) : 530(W) x 540(D) x 900(H)

WF-T5101(~5), T6101(~5), T5401(~5) : 540(W) x 540(D) x 850(H)

WF-T5111(~5), T6111(~5), T5411(~5) : 540(W) x 540(D) x 890(H)

30 - 800 kPa (0.3 -8 kgf /cm²)

In our continuing effort to improve the quality of our appliances, it may be necessary to make changes to the appliance without revising this manual.



LG Electronics Inc.

