



**Video Cassette Recorder  
OWNER'S MANUAL**

**MODEL: BC490W/BC290W**



**Before connecting, operating or adjusting this product,  
please read this instruction booklet carefully and completely.**

# Precautions & features

## Information



Position your VCR so that no bright light or sunlight falls directly onto it.

Care should be taken not to expose your VCR to any unnecessary vibration, moisture, dust or heat.

During electrical storms it is advisable to unplug both the aerial cable and mains plug to prevent accidental damage to your VCR and TV.

**Do not operate your VCR if it is damaged. Your VCR should not be repaired by anyone except qualified service personnel.**

Never remove the back cover of your VCR as this can expose you to very high voltage and other hazards. If your VCR does not operate properly, please check the Troubleshooting Check List (see p. 28). If your VCR still does not operate properly, unplug it and call your dealer.



Just to name a few examples of the extraordinary features:

- ez (easy) operations (see p. 26)
- Programmable 80 channel memory with Frequency synthesised tuner
- ACMS (Automatic Channel Memory System)
- 7 event/1 month programmable timer
- Shuttle Controls (BC490W)
- LP - Long Play - recording & playback
- ICON OSD (On Screen Display)
- Energy Saving function
- NTSC playback on PAL TV
- Logic & Picture Search
- Child Lock
- Auto Head Cleaner
- Auto Power on and Play
- Frame advance & Slow motion functions (BC490W)
- Still function
- Real Time Counter
- Quick Start function
- Auto Tracking System



## Welcome to LG

Thank you for buying this LG video cassette recorder Model **BC490W/BC290W**.

<b>Description</b>	<b>2 - 5</b>	<b>Advanced Operations</b>	<b>19 - 26</b>
Precautions & features	2	Instant Timer Recording (ITR)	19 - 20
Remote Control Location & function	4	Timer Recording using On Screen Display	21 - 22
Your VCR's Controls	5	Energy Saving	23
<b>Setting Up</b>	<b>6 - 14</b>	On Screen Display	23
Connecting to a TV & Camcorder	6	Tape Counter Memory Stop	24
Tuning in a video channel on your TV	7 - 8	Child Lock	24
How to use the main menu	9	Automatic Memory Power Shut-Off	25
Tuning in TV Stations Automatically	10	Video Doctor (Self-Diagnosis)	25
Tuning in TV Stations Manually	11 - 12	ez (easy) Operations	26
Changing the order of TV Stations	13	<b>Helpful Hints</b>	<b>27 - 28</b>
Deleting & Selecting TV Stations	14	Tape Copying	27
<b>Basic Operations</b>	<b>15 - 18</b>	Specifications	27
Playing a tape	15 - 16	Troubleshooting Check List	28
CM (Commercial Message) Skip	16		
OPR (Optimum Picture Response)	16		
Setting the Colour System	17		
Setting the Clock Manually	18		

# Table of Contents

# Remote Control

## Location & Function

**To install batteries:**  
Your REMOTE CONTROL HANDSET is powered by two AA type batteries.

1. To insert them, push the tab backwards and lift off the cover of the handset.
2. Put the two batteries into the compartment making sure the + and - are correctly positioned.
3. Replace the cover.

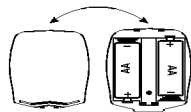

Your video recorder (VCR) is designed so that almost all of its features can be controlled from the REMOTE CONTROL HANDSET. Some features can also be controlled from the FRONT PANEL of the video recorder. The maximum operating distance that you may control your video recorder is about 7.5 metres (25 feet). It must also be within an angle of 30 degrees either side of the REMOTE SENSOR on the front of your video recorder.

To avoid damage from possible battery leakage, remove the batteries if you do not plan to use the remote control handset for an extended period of time. Do not use batteries of differing age or type. Always discard batteries safely.

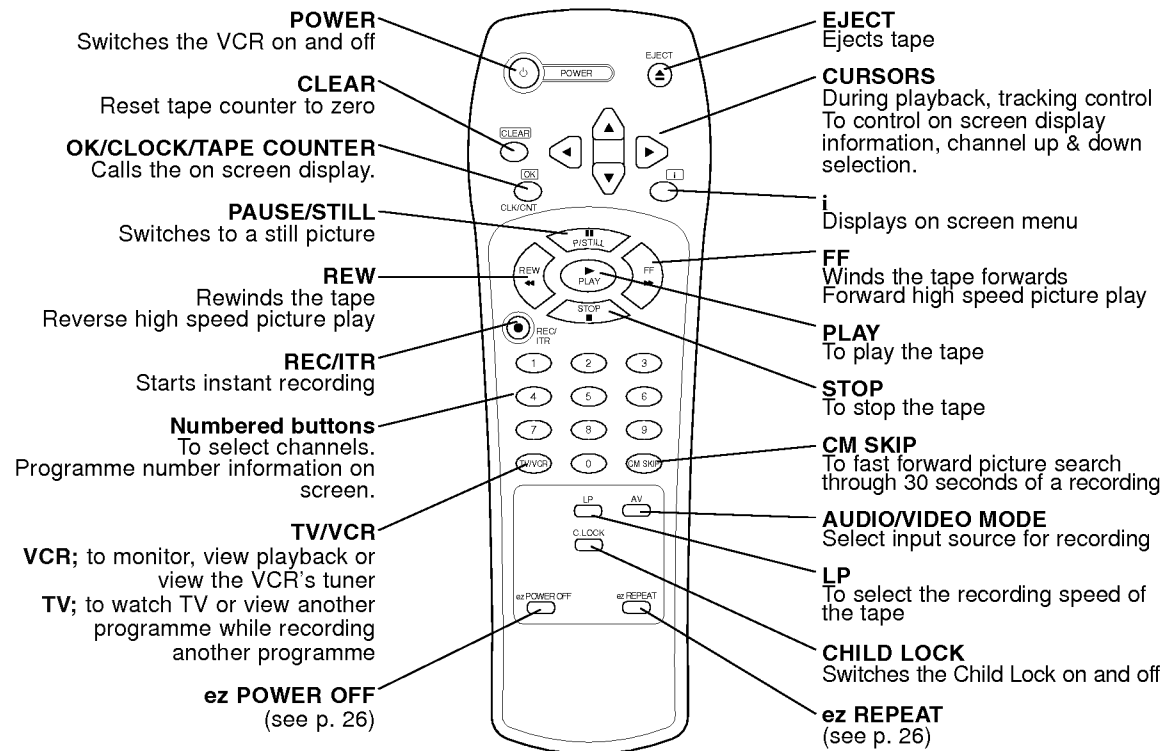

# Your VCR's Controls



Each button on your VCR has the same function as its corresponding button on the remote control handset.

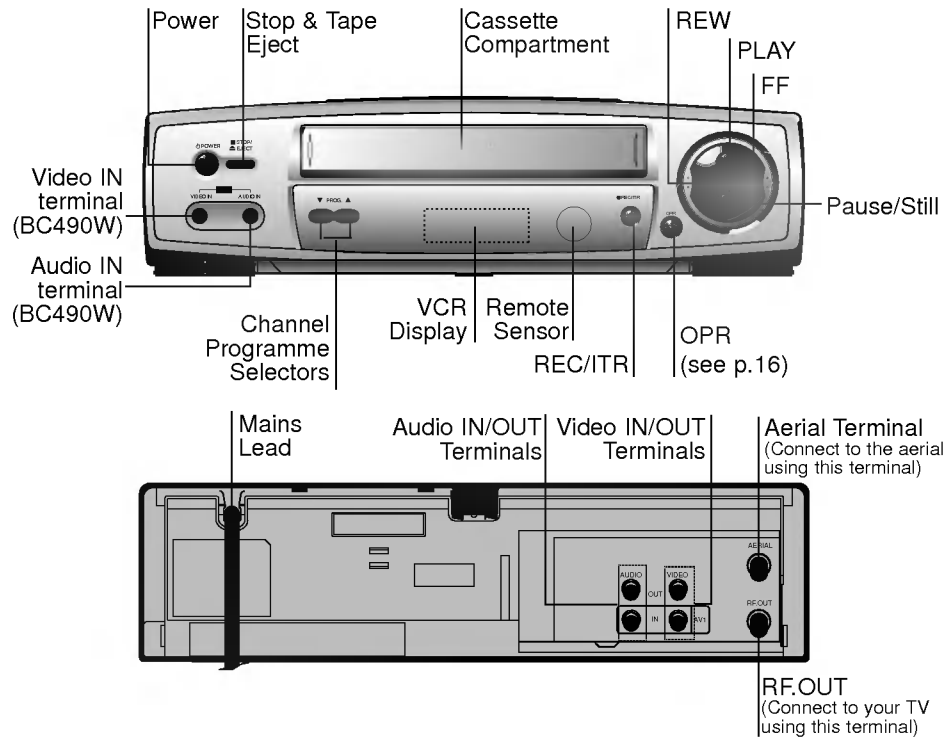

# Connecting To a TV & Camcorder

## Using your VCR very first time

Following picture will display on the TV screen when you have just connected your video recorder for the very first time.

To make tuning TV stations, please follow stages 3 to 4 as shown "ACMS" (see p. 10).

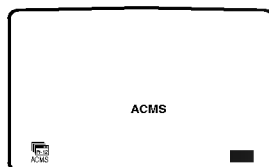

Make sure all connections are made with both your VCR and additional appliance unplugged from the mains to avoid damaging your equipment. Connecting a VCR using a RCA lead is one of the best ways to achieve optimum sound and picture quality from video-tape playback.

### Aerial

The quality of the sound and picture can be greatly influenced by the positioning, quality and state of repair of your external aerial.

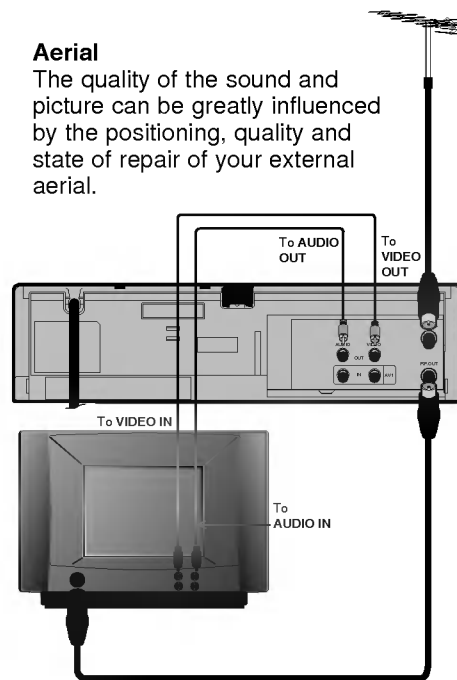

All connections must be made with all appliances unplugged from the mains.



Make sure all connections are made with both your VCR and camcorder unplugged from the mains to avoid damaging your equipment. To make connecting your camcorder easier we have designed the Audio IN and Video IN terminals on the front panel of your VCR(BC490W).

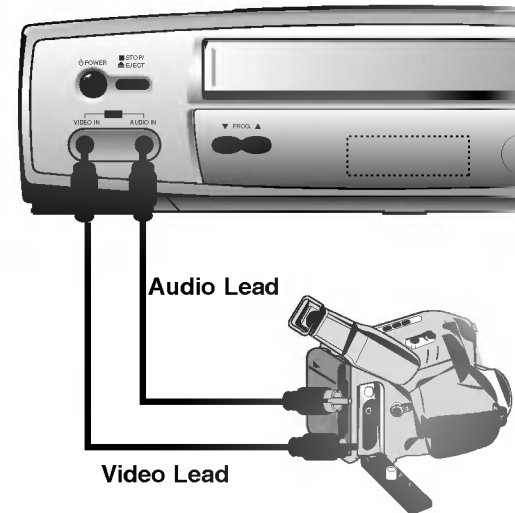



Your TV receives signals from the video recorder (VCR) like another TV station. You have to select a channel number on your TV and tune it in so that you may watch video tapes. If you connect a monitor or a TV set equipped with **RCA** terminal this adjustment will not be necessary, simply select the **AV** mode on your TV.

**1**

Make sure that you have correctly installed your VCR as described earlier in this book.

Press **POWER** to turn on your VCR.

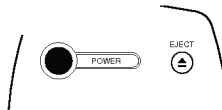

Turn on your TV.

**2**

Insert a pre-recorded video tape into your VCR and press **PLAY** on the remote control.

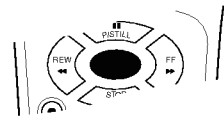

Select a TV channel number on which you wish to watch video's.

Don't worry if you don't have a video-tape to play at this stage! If you switch your VCR on and continue stages **3 ~ 4**, instead of seeing video playback tune your TV until you see a bright blue screen.

**3**

Tune this channel until the video picture is sharp and the sound is clear.

If you have used a **RCA** cable you will not have to tune your TV, simply select the **AV** channel. The **AV** channel is already pre-tuned for optimum video playback on your TV.

**4**

Store this channel on your TV.

You will need to look at the TV instruction book if you do not know how to do this.

## Tuning in a Video channel On your TV

The output frequency of this video recorder (VCR) is set at UHF channel 36. If channel 36 is already used by another TV station, or if the picture is distorted, you can change the transmitter channel of your VCR. Stages 5~8 will show you how to change the output frequency of your VCR.

# Tuning in a Video channel On your TV



Make sure that you have correctly installed your VCR and successfully tuned in a dedicated video channel on your TV. If you do not tune in a dedicated video channel on your TV you will be unable to view and record video tapes!

**5**

Only carry out stages 5 ~ 8 if you cannot obtain clear video playback as described in stages 1 ~ 4.

Select a TV channel number on which you wish to watch video's.

Make sure that your VCR is in standby by pressing **POWER** on the remote control (only the clock will be displayed).

**6**

Press **PROG. ▲** or **▼** on the front of your VCR for more than 4 seconds.



**CH36** will appear in the VCR display.

The following picture will be displayed on the TV screen.

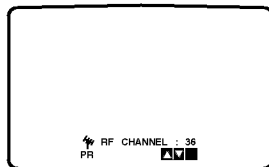

**7**

Press **PROG. ▲** or **▼** to select another video channel.



You may select any channel number between 22 and 68.

**8**

Select a TV channel number on which you wish to watch video's.

Tune this channel so that a bright blue screen appears.

Store this channel on your TV.

Press **POWER** when you have finished.







This VCR can easily be programmed by using the menu displayed on screen. The menus are controlled from the REMOTE CONTROL HANDSET.

**1**

Turn on your TV set.

Press **POWER** to turn on your VCR.

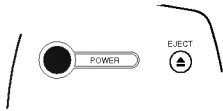

**2**

Press **i**.

The main menu will appear on the TV screen.

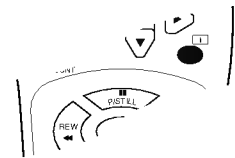

**3**

Press **◀** or **▶** to select the desired menu.

Press **OK** and press **▲** or **▼** to select the sub menu.

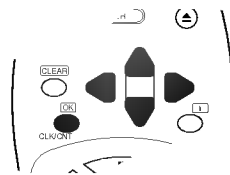

**4**

Press **"i"** to remove the menu.

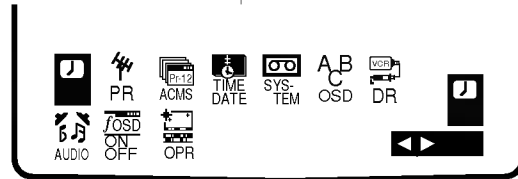
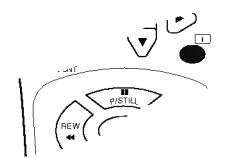

- **REC** - Timer recording setting (see p. 21 to 22).
- **PR** - Manual tuning setting (see p. 11 to 12).
- **ACMS** - ACMS (Automatic Channel Memory System) (see p. 10).
- **TIME DATE** - Date & clock setting (see p. 18).
- **SYSTEM** - To set the Colour System (see p. 17).
- **ABC OSD** - To change the language setting for OSD (see right).
- **DR** - To check a problem with your VCR (see p. 25).

- **AUDIO** - To select the channel of audio output according to your TV type ("B/G" for PAL B/G TV, "D/K" for PAL D/K TV)
- **F.OSD ON/OFF** - To switch the display of operational mode of your VCR ON or OFF (see p. 23).
- **OPR** - To improve the playback picture (see p. 16).

#### LANGUAGE SELECTION

You can select the language among English, Russian, Deutsch, Francais, and Polski.

**How to use the main menu**

# Tuning in TV stations Automatically

**1**

Make sure that you have correctly installed your VCR and tuned a video channel on your TV as described earlier in this book.

Switch on your TV and select the channel you wish to watch videos.

Press **POWER** to turn on your VCR.

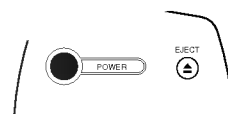

**2**

Press **i**.

The main menu will appear on the TV screen.

Press **◀** or **▶** to select the **ACMS**.

Press **OK**.

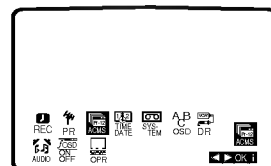
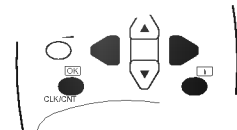

**3**

Press **OK** to start the automatic tuning process.

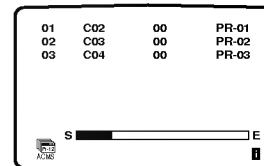
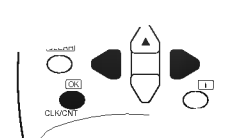

**4**

The TV station table will appear when tuning is complete.

Press **i** to save your settings.

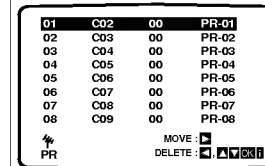
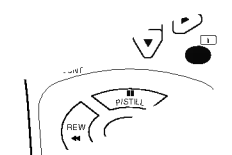



In certain areas of the country broadcast signals may be too weak for your VCR's automatic tuning process to find or assign TV stations correctly. You must tune in these weaker broadcast stations manually in order for your VCR to store them.

# Tuning in TV stations Manually

**1**

Press **i**.

The main menu will appear on the TV screen.

Press **◀** or **▶** to select the **PR**.

Press **OK**.

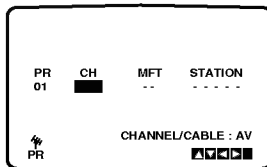
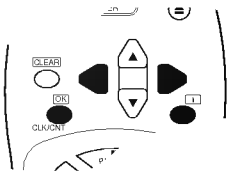

**2**

Press **i**.

The station table will appear.

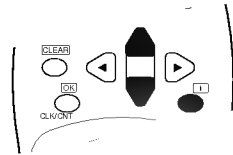

Press **▲** or **▼** to select the programme number that you want to tune (for example, PR 07).

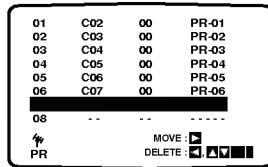

**3**

Press **OK**.

Press **AV** to select **C** (Standard stations) or **S** (Cable stations): C02 - C71, S01 - S41.

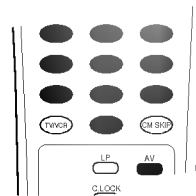

Enter the channel number of station that you want to tune with the **numbered buttons**.

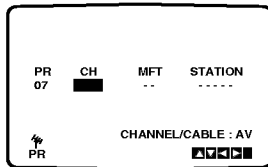

**4**

Searching will stop when it locates a station.

Control the fine tuning of the station by pressing **▲** or **▼**.

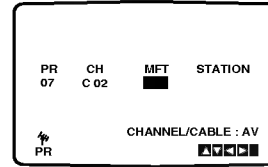
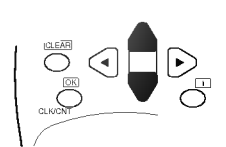

# Tuning in TV stations Manually

**5** Press **▶** to select **STATION** and press **OK**.

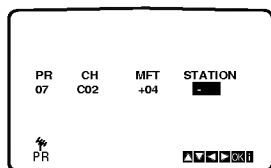
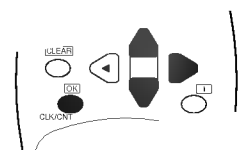

**6** Press **▲** or **▼** to select **letters** and **numbers** for the new station name.

Press **◀** or **▶** to move back and forth between characters.

Press **OK**.

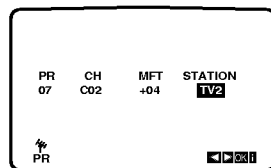
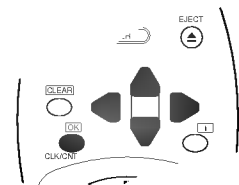

**7** Press **i**, confirm the station placement.

If you wish to manually tune other stations repeat stages 1-7.

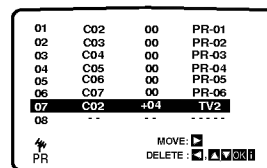
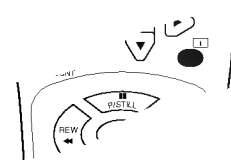

**8** Press **i** again to remove the menus from the TV screen.

Your new TV station has now been tuned into your VCR.



# Changing the order of TV stations



After tuning TV stations into your VCR you may wish to **change** the order in which they are stored without having to retune them against! The instructions given on this page will show you how you can simply move them into your desired order.

**1**  
Press **i**.

The main menu will appear on the TV screen.

Press **◀** or **▶** to select the **PR**.

Press **OK**.

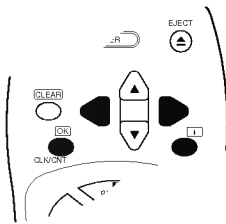

PR	CH	MFT	STATION
01	█	00	ARD

CHANNEL/CABLE : AV

**2**  
Press **i**.

Press **▲** or **▼** to select the **programme number** you want to move (for example, PR 03).

Press **▶**.

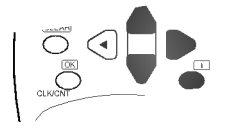

01	C02	00	ARD
02	C03	00	ZDF
03	█	█	█
04	C05	00	BR3
05	C06	00	HR3
06	C07	00	N 3
07	C08	00	NDR3
08	C09	00	SWF3

**3**  
Press **▲** or **▼** to place the cursor line at the position where to insert the selected programme. (for example, PR 05)

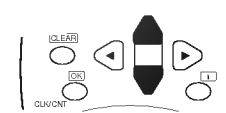

01	C02	00	ARD
02	C03	00	ZDF
03	C05	00	BR3
04	C06	00	HR3
05	█	█	█
06	C07	00	N 3
07	C08	00	NDR3
08	C09	00	SWF3

**4**  
Press **OK**.

The selected programme will be moved to the new programme number.

Press **i**.

If you wish to move other TV stations repeat stages 1 - 4.

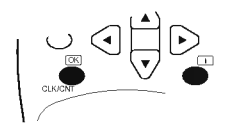

01	C02	00	ARD
02	C03	00	ZDF
03	C05	00	BR3
04	C06	00	HR3
05	█	█	█
06	C07	00	N 3
07	C08	00	NDR3
08	C09	00	SWF3

# Deleting & Selecting TV Stations



## Selecting stored TV stations:

Stored TV stations can be selected in either of two ways. Press ▲ or ▼ to select different stations that are tuned into your VCR.

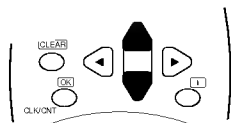

You may also directly select stations using the **numbered buttons** on the remote control.

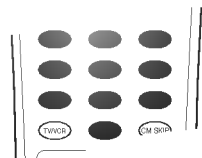

After tuning TV stations into your VCR you may wish to **delete** a station. The instructions given on this page will show you how easily delete any unwanted TV stations.

**1**

Press **i**.

The main menu will appear on the TV screen.

Press ◀ or ▶ to select the **PR**.

Press **OK**.

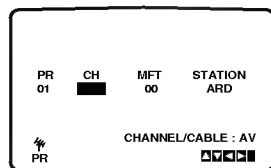
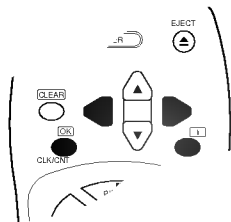

**2**

Press **i**.

Press ▲ or ▼ to select the **programme number** you want to delete. (for example, PR 01)

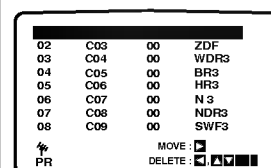
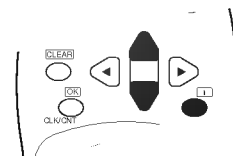

**3**

Press ◀.

After a short while, the selected station will be deleted.

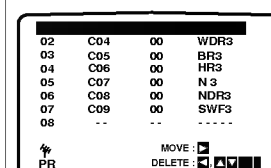
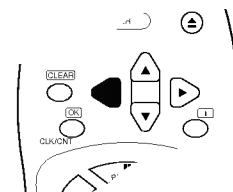

**4**

Press **i**.

If you wish to delete other TV stations repeat stages 1 - 4.

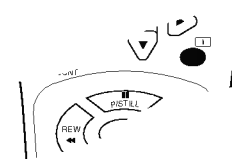

# Playing a tape



You will only be able to load and eject video cassettes when your VCR is plugged into the mains. Your VCR may also play back recordings from NTSC tapes (on PAL TV).

## Getting a better picture

When a cassette is inserted and playback started, the automatic tracking function works to get the best possible picture automatically. If the quality of the recording is poor, repeatedly press ▼ or ▲ on the remote control to manually adjust the tracking until any distortions have been removed. Press numbered 0 on the remote control to switch automatic tracking back on again.

**1**

Make sure that you have correctly connected your VCR as described earlier in this book.

Turn on your TV and select the video channel for video playback.

Press **POWER** to turn on your VCR.

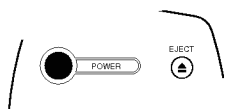

Insert the video cassette into your VCR.

The video cassette should have the window side facing up and the arrow facing away from you.

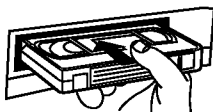

**2**

Press **PLAY** to start playing your tape.

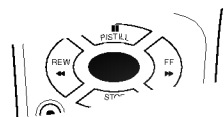

If you load a video cassette which has had its record protection tab removed playback of the cassette will start automatically.

## AUTO TRACKING

Your VCR will automatically adjust the tracking to give the best picture quality.

**3**

## Still picture :

Press **P/STILL** to pause a picture.

Press **P/STILL** repeatedly to advance the still picture frame by frame(BC490W).

Press ▲ or ▼ to reduce the vertical tremble during still picture(BC490W).

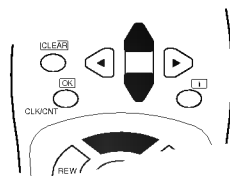

Still pictures will have a lot of white streaks across them, this is quite normal and doesn't mean that there is anything wrong with your VCR! Tapes can be paused for up to 5 minutes. After 5 minutes your VCR will stop playing the tape to prevent damaging the tape or your VCR.

**4**

Press **PLAY** to continue playing your tape.

## Picture search:

During playing back press either **FF** or **REW** to this will enable you to rapidly wind the tape (7 times normal playback speed) and see where you are on the tape.

## Logic search:

During fast forwarding or rewinding press and hold **FF** or **REW** the picture will be played back at 7 times normal playback speed.

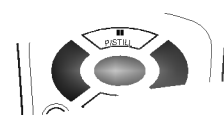

# Playing a tape

 During playback of a video cassette you can select picture sharpness by pressing **OPR** on the front of your VCR.

- Press 1:  
To make a picture **softer**.
- Press 2:  
To make it **clearer**.
- Press 3:  
To switch off.



Picture search will only continue for about 3 minutes, after which your VCR will return to normal playback. During picture search, logic search, and CM Skip the sound is muted and there will be some noise streaks on the picture.

**5**  
**Slow motion playback, Shuttle (BC490W)**  
During playing back or still picture press ◀ or ▶.

You can reach the following playback speeds.  
(-7xplay, -3xplay, -play, still, 1/19 slow, play, 2xplay, 7xplay)

To switch off the slow motion and shuttle, press the desired function.

During slow motion and shuttle, the noise bars may appear on the picture according to the status of tape.

If distortions can be seen in the picture, reduce them with ▲ or ▼.

**6**  
Press **STOP** to end playback.

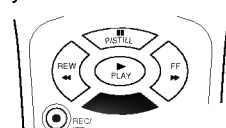

Press **EJECT**.

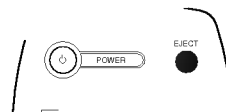

If the end of the tape is reached, your VCR will stop playback automatically, rewind, stop, eject the tape and place itself into power off.

## CM (Commercial Message) Skip:

This feature enables you during playback of a tape to skip a commercial break in a few seconds, then resume normal playback.

While tape is playing press **CM SKIP** on the remote control to skip commercial (or another programme material).

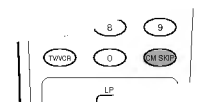

Repeatedly press **CM SKIP** to skip material:

- |         |             |
|---------|-------------|
| 1 Press | 30 seconds  |
| 2 Press | 60 seconds  |
| 3 Press | 90 seconds  |
| 4 Press | 120 seconds |
| 5 Press | 150 seconds |
| 6 Press | 180 seconds |

## OPR (Optimum Picture Response):

This feature automatically improves playback picture quality by adjusting your VCR to the condition of the tape.

Press **i**.  
Press ◀ or ▶ to select **OPR**.  
Press **OK**.



Press ▲ or ▼ repeatedly to select: **OFF, SOFT** or **SHARP**.

Please note you may only set OPR to on when playing a tape.

Press **i** to remove the menus.





Your VCR is equipped with triple colour standard, you can play back a tape in PAL B/G and SECAM D/K.

During playback your VCR detects the colour system automatically. If there are colour problem please select the colour system manually.

**1**

Press **i**.

The main menu will appear on the TV screen.

Press **◀** or **▶** to select the **SYSTEM**.

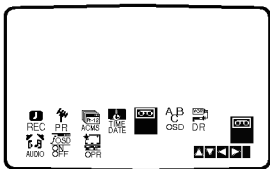
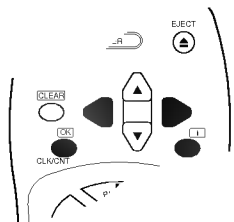

**2**

Press **OK**.

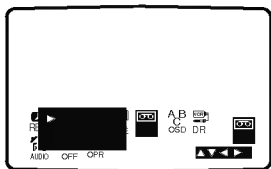
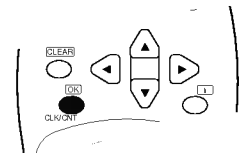

**3**

Press **▲** or **▼** to select according to the **COLOUR** system used.

**AUTO** : automatic colour selection,

**PAL** : PAL recordings

**MESECAM** : MESECAM recordings.

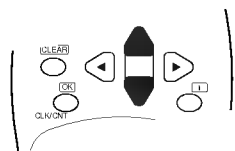

**4**

Press **i** to remove the menus from the TV screen.

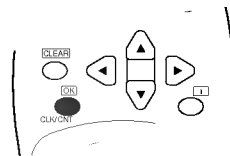

## Setting the Colour System

# Setting the Clock Manually

The clock in your VCR controls time, day and date settings for your VCR.



**1**

Press **i**.

Press **◀** or **▶** to select **TIME DATE**.

Press **OK**.

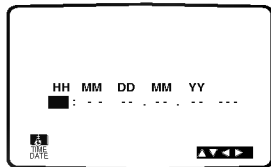
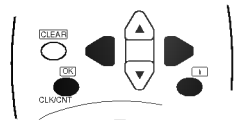

**2**

Use the **numbered buttons** on the remote control to alter or enter the **HOURS, MINUTES, DAY, MONTH** and **YEAR**.

Please note your VCR uses a 24 hour clock. e.g. 1 pm will be displayed as 13:00.

When entering singles numbers a 0 must be added first, for example 1 must be entered as 01, 2 as 02 etc.

The day of the week will appear automatically when you enter the date.

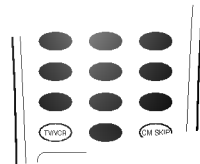

**3**

If you make a mistake press **◀** or **▶** and enter the correct details.

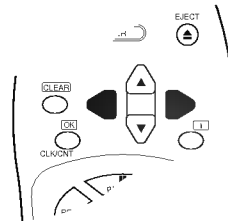

**4**

Press **i**.

Your new clock settings are stored and will appear on your video recorder's display.

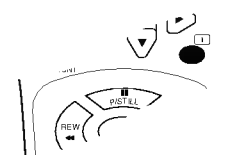



Your VCR allows you to make recordings using a variety of simple methods :  
**Instant Timer Recording (ITR)** start recording immediately for a set period of time or until the video cassette runs out.

**Timer Recording** you may record at a later time (up to 1 month from the present). Up to 7 of these automatic recordings may be set.

## Instant Timer Recording (ITR)

**1**

Make sure that you have correctly installed your VCR as described earlier in this book.

Turn on your TV and select the channel that you set up for video playback.

Press **POWER** to turn on your VCR.

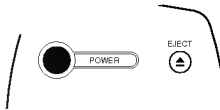

**2**

Insert a video cassette with protection tab into your VCR.

The video cassette should have the window side facing up and the arrow facing away from you.

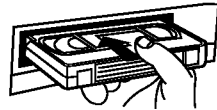

**3**

Press **▲** or **▼** to select the **programme number** you wish to record.

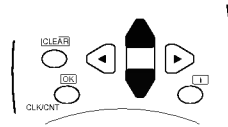

You may also directly select programme number using the **numbered buttons** on the remote control.

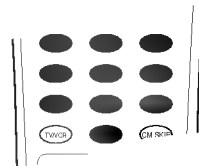

**4**

If you wish to record directly from the AUDIO/VIDEO IN terminals on the back (AV1) or on the front (AV2 : BC490W) of your VCR press **AV**, as shown by the display (AV1 or AV2) on the TV screen.

If you do not wish to record on a tape (this can happen quite easily by accident!) remove the protection tab on the back edge of the video cassette.

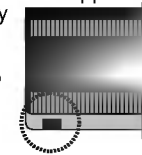

It is possible to record on a video cassette with the record protection tab removed by covering the hole with self adhesive tape.

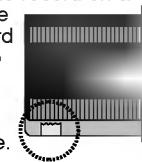

# Instant Timer Recording(ITR)

Remember you can record one programme while watching another by starting your ITR recording, press **TV/VCR** to select TV mode and then select a different channel on your TV.

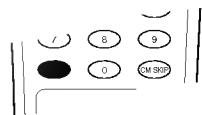

Your VCR incorporates Long Play (LP) which enables you to record up to twice the amount of time on a video cassette. For example an E-180 will record up to 180 minutes using Standard Play (SP); using LP you will be able to record up to 360 minutes. **Please note** there will be a slight loss in picture and sound quality when using LP.

**5**

Press **LP** if you wish to record in Long Play or Standard Play.

SP will produce improved picture and sound quality, however LP will provide twice as much recording time as SP. SP or LP will be displayed in your VCR display to let you know which you have selected.

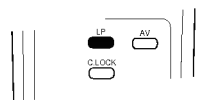

**6**

Press **REC/ITR** to start recording.

RECORD will appear on the TV screen.

Press **REC/ITR** several times. Each successive press will increase the record time by 30 minutes until you reach a maximum of 9 hours.

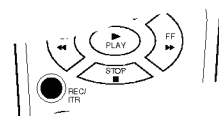

**7**

Press **P/STILL** to avoid recording unwanted scenes.

Press **P/STILL** again to continue recording.

Tapes can be paused for up to 5 minutes; RECP will be displayed when a tape is paused. After 5 minutes your VCR will stop recording to prevent damaging the tape or your VCR.

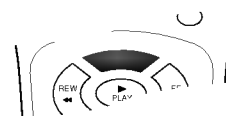

**8**

Press **STOP** to end recording.

Press **EJECT**.

EJECT will appear on the TV screen for a few seconds.

If the end of the tape is reached, your VCR will stop recording automatically, rewind, stop, eject the tape and place itself into power off.

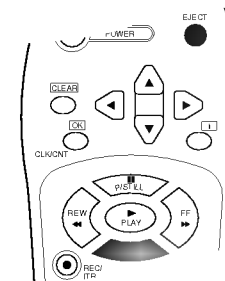



**If timer record events overlap...**

Make sure that the preset times of the timer recording events do not overlap. If they do, the earlier programme will always be given priority.

**Example:**

Programme 1 is programmed to start at 10:30 and end at 11:30.

Programme 2 is programmed to start at 11:00 and end at 12:00.

(In this case, Programme 1 will be recorded in its entirety, but only the last 30 minutes of Programme 2 will be recorded.)

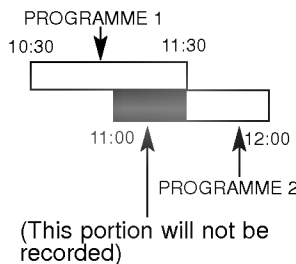

If at a later date you wish to **delete** or **change** any of the settings in timer event memory you may do so without having to enter all the timer event information again. Simply display the timer event screen. Press **▲** or **▼** to select the event that you wish to **delete** or **change**.

Press **◀** to delete the event.  
Press **OK** to change; then press **◀** or **▶** to select Station, Date, Start and End times, and LP. Press **▲** or **▼** to enter the correct information.

**5** Press the **numbered buttons** to enter the date of the programme.

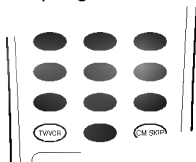

If you press **OK** before entering the date you may select one of the following automated recording features.

Press **◀** or **▶** to select, then press **OK** to confirm.

**DLY(Daily)** To record every day (except Saturday and Sunday) at the same time.

**Weekly** To record at the same time every week.

PR	DATE	TIME	SP
PR-01	■	.....	SP
..	..	.....	SP
..	..	.....	SP
..	..	.....	SP
..	..	.....	SP
..	..	.....	SP
..	..	.....	SP
..	..	.....	SP
■	SU MO TU WE TH FR SA		

**6** Press the **numbered buttons** to enter the recording start and end times of the programme that you wish to record.

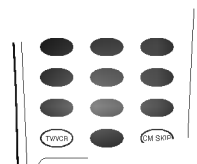

Please note your VCR uses a 24 hour clock. e.g. 1 pm will be displayed as 13:00. You may also select the the start and end times by pressing **▲** or **▼**.

PR	DATE	TIME	SP
PR-01	26	10:00-11:■	SP
..	..	.....	SP
..	..	.....	SP
..	..	.....	SP
..	..	.....	SP
..	..	.....	SP
..	..	.....	SP
..	..	.....	SP

**7** Press **▶** to select the recording speed. Press **▲** or **▼** if you wish to record in Long Play or Standard Play. Check that the timer event details are correct. Press **i** to save your settings.

If **PLEASE CHECK** is displayed, you have entered incorrect information and will need to re-enter the data. If you want to make other Timer recordings repeat stages **3 - 8**. Press **i** again to remove the menus.

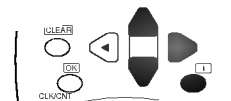

PR	DATE	TIME	SP
PR-01	26	10:00-11:00	■
..	..	.....	SP
..	..	.....	SP
..	..	.....	SP
..	..	.....	SP
..	..	.....	SP
..	..	.....	SP
..	..	.....	SP
REC. SPEED :	SP		

**8** Press **POWER** to switch your VCR off.

TIMER will appear in the video recorder's display while your VCR waits to make the recording.

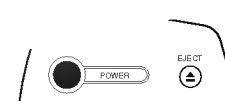



Your VCR has an Energy Save feature which if set will place your VCR into an economic power save where the clock display will disappear. If you have programmed a recording, this feature will not work.

**1**

Press **POWER** on the **VCR**.

The VCR and clock will appear on the video recorder's display.

**2**

Press **POWER** on the **VCR** again and your VCR will go into **Energy Save**.

All indicators will turn off in the video recorder's display.

Press **POWER** to switch off **Energy Save**.



You may easily display the current time or tape counter and amount of tape left, day, month, year, day of week, tape speed programme channel, and operational mode of your VCR on the TV screen. If a recording is taking place On Screen Displays will not be recorded onto the tape.

**1**

Press **OK/CLK/CNT** to display.

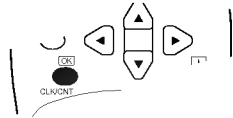

VCR Function/  
Tape Speed

Channel  
Programme

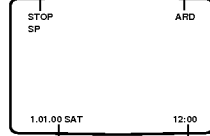

Day/Month/  
Year/Day of  
Week

Clock/Tape  
Counter &  
Amount of  
Tape Left

Press **OK/CLK/CNT** repeatedly to display the tape counter and amount of tape left.

**2**

After 3 seconds the display will clear only leaving the clock or tape counter and amount of tape left on the TV screen.

Press **OK/CLK/CNT** again to remove all displays from the TV screen.

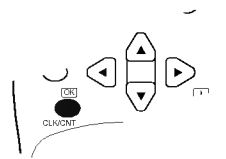

# Energy Saving On Screen Display

# Tape Counter Memory Stop Child Lock



The **Digital Tape Counter** can be displayed on your TV screen instead of the time by pressing **OK/CLK/CNT** on the remote control. The Digital Tape Counter indicates the relative positions of recordings on the tape.

**1**

Press **OK/CLK/CNT** repeatedly until the counter is displayed on screen.

Press **CLEAR** to set the counter to 0:00:00.

Press **PLAY** or start recording.

The tape counter will display the actual play time in hours, minutes and seconds.

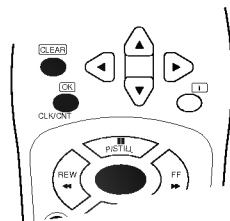

**2**

Press **STOP** when playback or recording is complete.

Press **REW**.

The tape will rewind and automatically stop when the counter returns to 0:00:00.

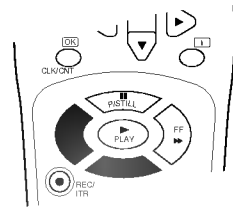

The control buttons on the front of the VCR can be switched off so that your VCR can only be operated using the remote control.

**1**

Press **C.LOCK**.

 **SAFE** will appear on the TV screen.

**SAFE** will flicker in your video recorder's display for a few seconds.

None of the buttons on the front of your VCR will work (except **STOP/ EJECT**)

If any buttons on the front of your VCR are pressed **SAFE** will flicker in your video recorder's display for a few seconds.

**2**

Press **C.LOCK** again to switch off the child lock.

 **SAFE** will disappear on the TV screen.

**OFF** will flicker in your video recorder's display for a few seconds.



# Automatic Memory Power Shut-Off

# Video Doctor (Self-Diagnosis)



## Automatic Memory Power Shut-Off

This feature of your VCR enables you to switch off your VCR automatically after tape rewind has been completed.

**1**

Press **POWER** during tape rewind.

**2**

The tape will rewind to the beginning and your VCR will automatically switch itself off.



## Video Doctor (Self-Diagnosis)

This feature informs you that there is a problem with your VCR. These error messages will appear on the TV screen.

**1**

Switch on your VCR.

Press **i**.

Press **◀** or **▶** to select **DR**.

Press **OK**.

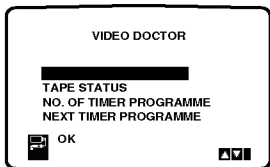
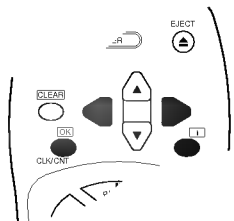

**2**

Press **▲** or **▼** to check a problem.

### HEAD STATUS

- **PLEASE CLEAN:** Clean your video heads.

### TAPE STATUS

- **NOT RECORDABLE:** Insert a tape with its protection tab in place

### NO. OF TIMER PROGRAMME

- **2** Shows the number of timer recording.

### NEXT TIMER PROGRAMME

- **PR-01 10:00~11:00** Shows the current status of timer recording.

Press **i**.

# ez (easy) Operations



## ez (easy) power off

Sequence of "Stop → Rewind → Eject → Power Off" is operated automatically by pressing ez POWER OFF.

**1**

During playing back press **ez POWER OFF**.

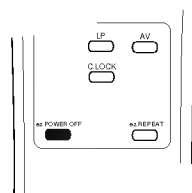

**2**

Your VCR will be operated as the following ;

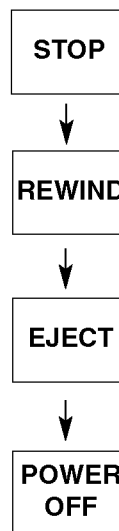

## ez (easy) repeat

By pressing & holding **ez REPEAT** during playing back, the holding section is replayed twice automatically.

**1**

During playing back, press & hold **ez REPEAT** at the point where repeat play is to be concluded. Then, your VCR is started reverse search.

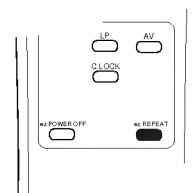

**2**

Release **ez REPEAT** at the point where repeat play is to start.

The holding section is replayed twice automatically.



Pressing **ez REPEAT** again during repeat play, return to normal play.

P/N: 3834RP0049W



A second VCR (for tape copying) should be connected to the AUDIO IN and VIDEO IN terminals on the front of your VCR(BC490W) or on the back of your VCR. Remember to select the appropriate audio/video mode by pressing the **AV** button on the remote control.

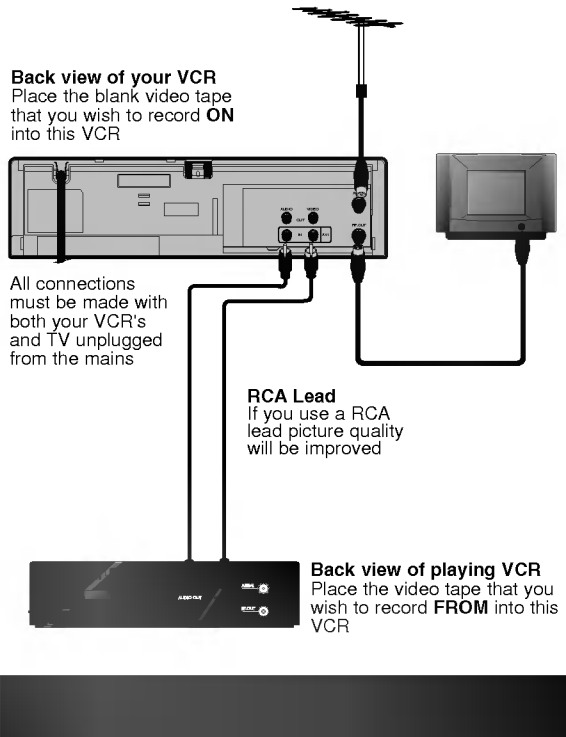

#### General

Power	110-240V~, 50/60Hz.
Power consumption	Approx. 16 Watts
Video Head System	Double azimuth 4 heads, helical scanning(BC490W) Rotary 2 heads, helical scanning (BC290W)
Tape speed	23.39 mm/sec (SP mode)/ 11.69 mm/sec (LP mode).
Tape format	Tape width 12.7 mm (0.5 inch).
Maximum recording time	4 hours (SP mode, E-240 tape)/ 8 hours (LP mode, E-240 tape).
Rewind time	Approx. 65 (+/-10) sec.(E-180 tape).
Dimensions	360 x 94 x 270 mm (W x H x D)
Weight	3.4 Kg.
Operating temperature	5°C - 35°C
Operating humidity	Less than 80%.
Timer	24 hours display type.

#### Video

Television system	CCIR standard (625 lines, 50 fields) PAL/SECAM colour signal
Recording format	PAL/MESECAM
RF reception	PAL/SECAM (B/G, D/K)
RF OUT	PAL G/K
Input level	VIDEO IN (RCA type) 1.0 Vp-p, 75 Ohm, unbalanced
Output level	VIDEO OUT (RCA type) 1.0 Vp-p, 75 Ohm, unbalanced
Signal to noise ratio	More than 43 dBm.
RF Modulator	UHF 22-68 (Adjustable).

#### Audio

Input level	AUDIO IN (RCA type) -6.0 dBm, more than 47 kohms
Output level	AUDIO OUT (RCA type) -6.0 dBm, less than 1 kohms
Track	Mono track
Frequency response	100 Hz-10 kHz (-6/+3 dB)
Signal to noise ratio	More than 43 dB (at SP mode)

# Specifications

# Tape Copying



The design and specifications are subject to change without notice.

# Troubleshooting

## Check List



### Video Head Cleaning

Whenever a video cassette is inserted into or ejected from your VCR the video head is automatically cleaned. This should mean that additional head cleaning should not be necessary. However dirt accumulating on the head after a long period of time can cause the playback picture to become blurred or broken up. High quality video cassette tapes will not normally deposit dirt onto the video head, but old or damaged tapes might.

Symptom	Check points	Symptom	Check points
<b>No picture &amp; no sound</b>	<p>Is the mains plug plugged in and switched on?</p> <p>Is the TV switched on?</p> <p>Try another channel, maybe a weak signal.</p> <p>Check aerial is it plugged in? Check aerial, is the lead broken or damaged?</p> <p>Have you tuned in a video channel on your TV to watch video on?</p> <p>If you have used a RCA lead to connect your VCR and TV have you selected the AV channel on your TV?</p> <p>Check tuning, carry out Automatic Tuning again</p>	<b>Video cassette cannot be inserted</b>	<p>Is the cassette compartment empty?</p> <p>Are you trying to insert the cassette the right way round?</p>
<b>No playback or poor picture</b>	<p>Are the TV channels tuned in properly?</p> <p>Have you tried using another cassette?</p> <p>Can you minimise the noise bars to an acceptable level with 0, ▲ or ▼ ?</p>	<b>Remote control does not work</b>	<p>Is the mains plug plugged in and switched on?</p> <p>Is the VCR switched on</p> <p>Check the batteries in remote control.</p>
<b>TV programmes cannot be recorded</b>	<p>Can you get a picture on the TV?</p> <p>Are the aerial leads and special RF connector lead between your VCR and TV connected?</p> <p>Are the TV channels tuned in properly?</p> <p>Has the safety tab on the video cassette been removed to prevent recording?</p> <p>Try another station, maybe a weak signal</p> <p>Check aerial is it plugged into TV?</p>	<b>The top of the playback picture is unstable</b>	<p>Is the video cassette damaged, have you tried using another one?</p> <p>Adjust the horizontal control on your TV.</p> <p>Check aerial is it plugged into VCR?</p> <p>Check aerial, is the lead broken or damaged?</p> <p>Check for local interference</p> <p>Make sure that you are using a video TV channel on your TV.</p>
		<b>Auto Play does not work</b>	<p>Has the safety tab been removed from the video cassette?</p>



**P/N: 3834RP0049W**