



# VACUUM CLEANER OWNER'S MANUAL

PLEASE READ CAREFULLY AND THOROUGHLY  
THE OPERATION INSTRUCTIONS AND SAFETY  
PRECAUTIONS BEFORE INSTALLING AND  
OPERATING YOUR VACUUM CLEANER.

MODEL: V-982TE  
V-982E

# IMPORTANT SAFEGUARDS

When using an electrical appliance, basic precautions should always be followed, including the following:

## READ ALL INSTRUCTIONS BEFORE USING THIS APPLIANCE

**WARNING**-To reduce the risk of fire, electric shock, or injury:

1. Do not leave appliance plugged in. Unplug it from the outlet when not in use or before servicing .
2. Do not use outdoors or on wet surfaces.
3. Do not allow it to be used as a toy. Close attention is necessary when used by children.
4. Use only as described in this manual. Use only manufacturer's recommended attachments.
5. Do not use with damaged cord or plug. If the appliance is not working as it should have been dropped, damaged, left outdoors, or dropped into water, return it to a service center.
6. Do not pull or carry by the cord as a handle, close a door on cord, or pull cord around sharp edges or corners. Do not run appliance over the cord. Keep the cord away from heated surfaces.
7. Do not unplug by pulling on cord. To unplug, grasp the plug, not the cord.
8. Do not handle plug or appliance with wet hands.
9. Do not put any object into openings. Do not use with any opening blocked; keep free of dust, lint, hair, and anything that may reduce air flow.
10. Keep hair, loose clothing, fingers, and all parts of body away from the openings and moving parts.
11. Do not pick up anything that is burning or smoking, such as cigarettes, matches, or hot ashes.
12. Do not use vacuum cleaner without filter.
13. Turn off all controls before unplugging.
14. Use extra care when cleaning stairs.
15. Do not use to pick up flammable or combustible liquids such as gasoline or use in areas where they may exist.
16. Hold the plug when rewinding onto cord reel. Do not allow the plug to whip when rewinding.
17. Do not use to pick-up the water.
18. Take electrical inspection when hose is cracked and its coat is peeled off.

**SAVE THESE INSTRUCTIONS**

# TABLE OF CONTENTS

<b>FEATURES</b> .....	4
<b>INSTALLATIONS</b> .....	5
<b>OPERATING</b>	
VACUUM CLEANER USE.....	6
DUST INDICATOR.....	7
CLEAN FILTER CLEANING.....	8
MICRO FILTER REPLACEMENT .....	9
AFTER CLEANING .....	9
ATTACHMENTS STORING .....	9
<b>BEFORE REQUESTING SERVICE</b> .....	10
<b>TROUBLE SHOOTING CHART</b> .....	10
<b>SPECIFICATIONS</b> .....	11

# FEATURES

It is important to know the vacuum cleaner parts and features to assure its proper and safe use.

Review these before using the cleaner.

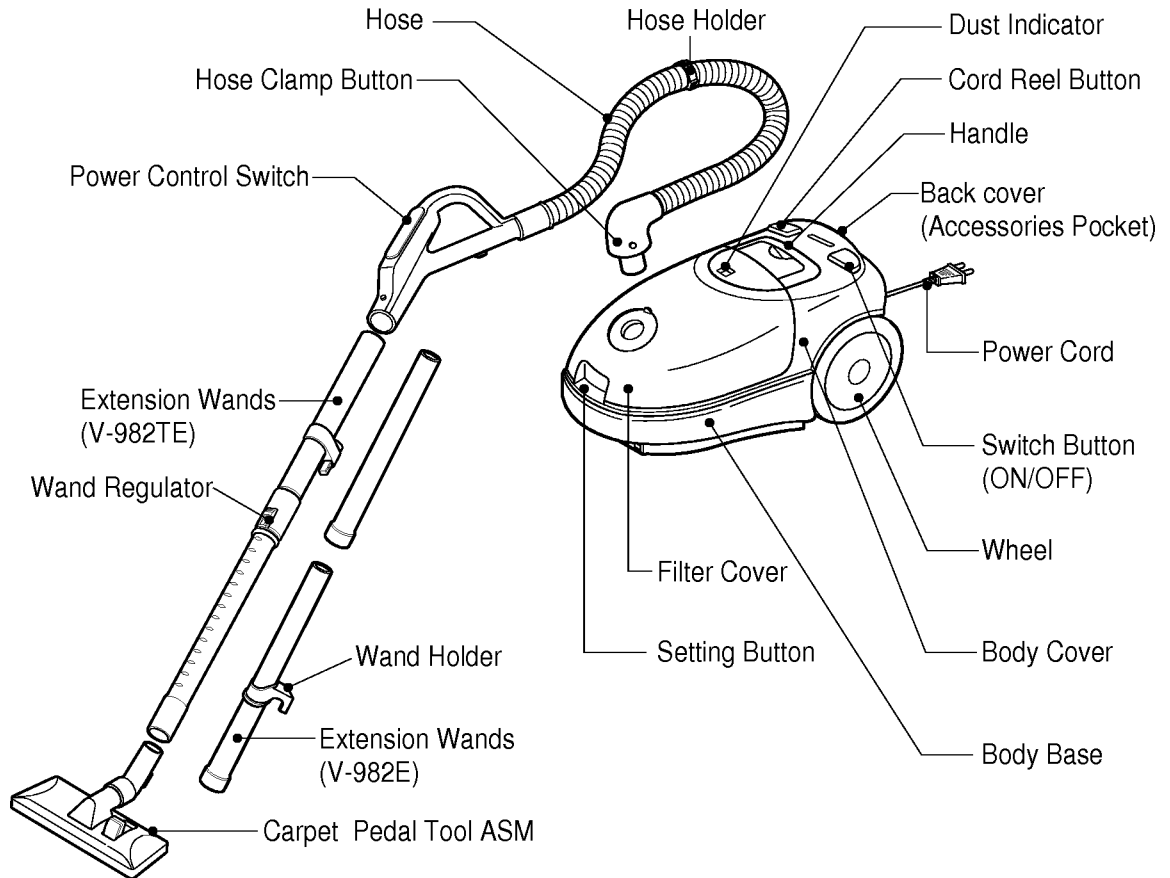

## ATTACHMENTS

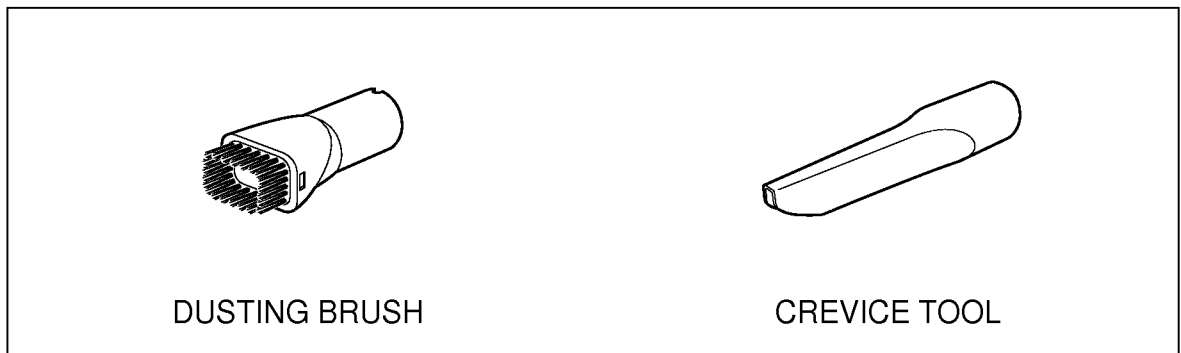

# INSTALLATIONS

Read this manual and follow these precautions before assembling or using your vacuum cleaner. When using electric appliances, basic cautions should be taken including the followings.

**WARNING:** Disconnect electrical supply before servicing and/or cleaning the unit, otherwise electric shock could occur and/or cleaner could suddenly start.

1. Electric shock could occur if used outdoors or on wet surfaces.
2. Keep children away from the vacuum cleaner at all times. Injury could result from suction.
3. Never leave a vacuum cleaner plugged in and unattended near children.
4. The cord moves rapidly when rewinding. Keep children away, provide a clear path and hold plug when rewinding the cord to avoid personal injury.

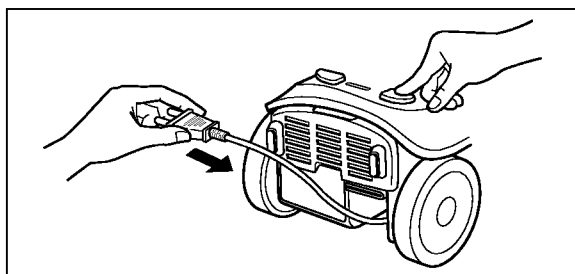

5. Always pull out the power cord by holding the plug, not the cord.

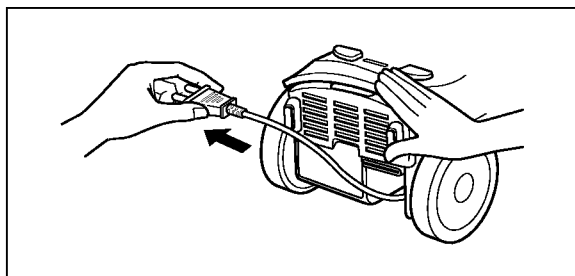

6. Always turn off cleaner before unplugging.

7. Unplug your cleaner whenever you leave it for more than a moment or when not in use.
8. Always check the dust bag after vacuuming carpet. Failure to change could cause permanent damages to the vacuum cleaner.

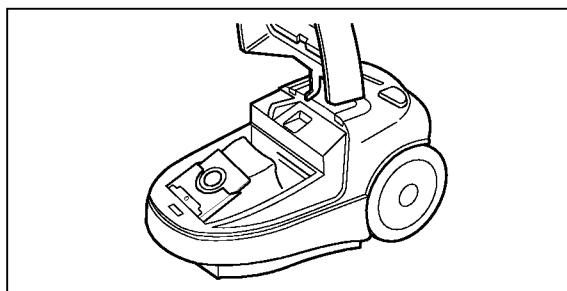

9. Don't keep cleaner on the chairs, tables, etc. Extra care must be taken when cleaning stairs.

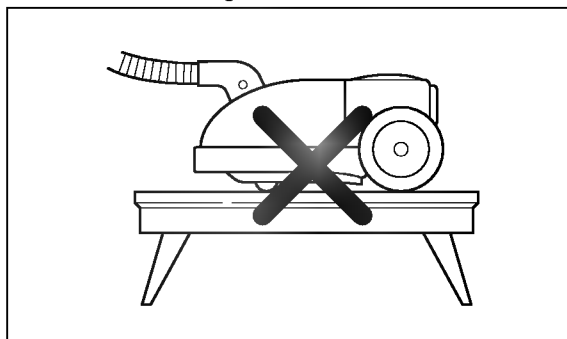

10. Never vacuum cigarette butts or fire-place ashes. Never use cleaner where flammable vapours like cleaning fluids, perfumes etc. These could cause a fire.

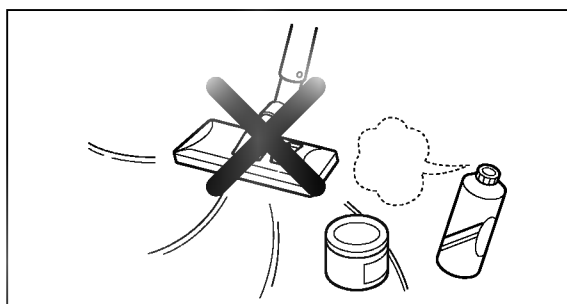

11. Store vacuum cleaner in a cool, clean, and dry place.
12. Never place sharp or heavy objects on a power cord. Shock or fire hazard could occur.

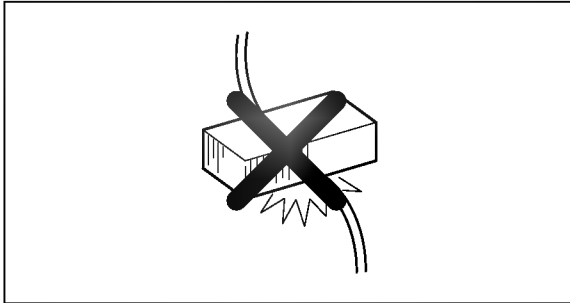

13. Never operate with a damaged cord or plug.
14. Never use the cleaner to pick up sharp hard objects, small toys, pins, paper, etc. They may damage the cleaner or dust bag.

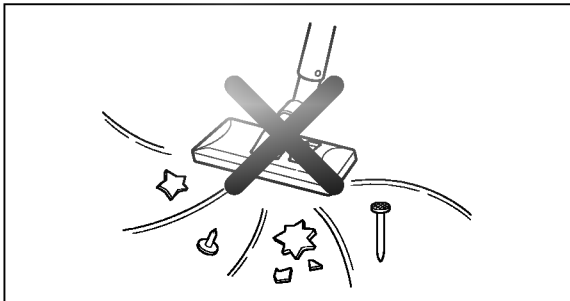

15. When not in use, you can attach the hose and the wand to the bottom of the cleaner in upright position. Push the holder into the holder slot on the bottom of the cleaner. (Fig 1)  
Also you can store the hose and the wand in horizontal position. Push the nozzle hook in the floor nozzle into the holder slot on the left of the cleaner body cover. (Fig 2)

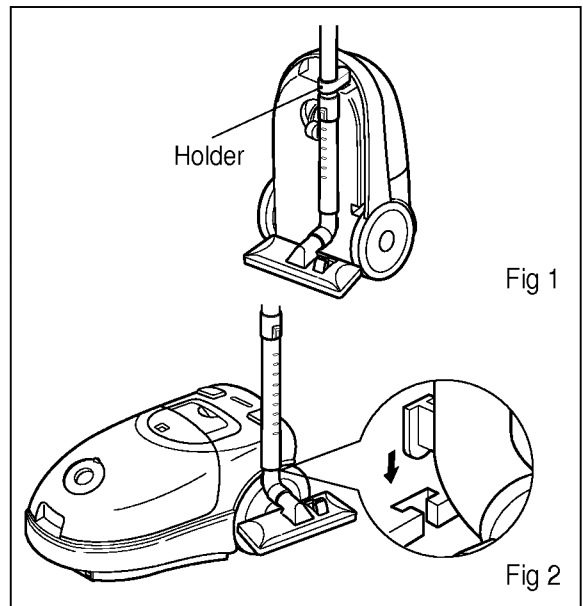

16. Use this vacuum cleaner only for those jobs expected for a home vacuum cleaner.

## OPERATING

### VACUUM CLEANER USE

1. CARPET PEDAL TOOL ASM Connection. Insert the wand firmly into the floor nozzle.
2. TELESCOPIC EXTENSIONS WAND use. Push the slider control downwards to extend or retract extension wand.

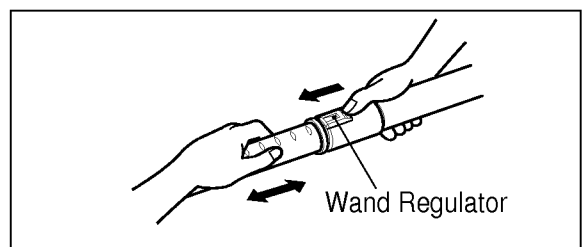
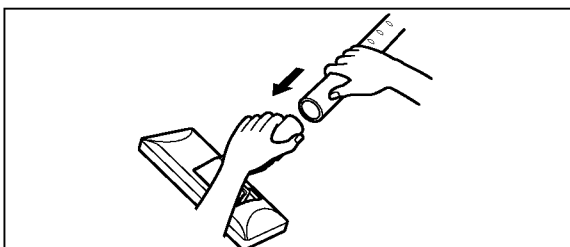

### 3. WANDS Connection

Insert the wands firmly into each other.

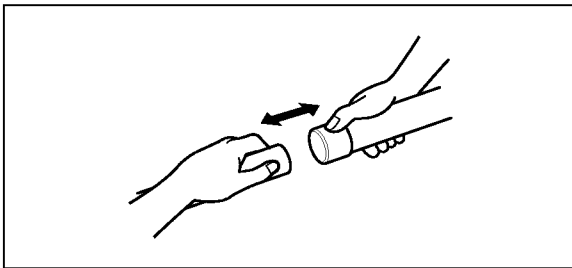

### 4. HOSE

- Insert the hose into body of the vacuum cleaner until a clicking sound is heard.
- To remove the hose, depress the hose clamp button and pull out.

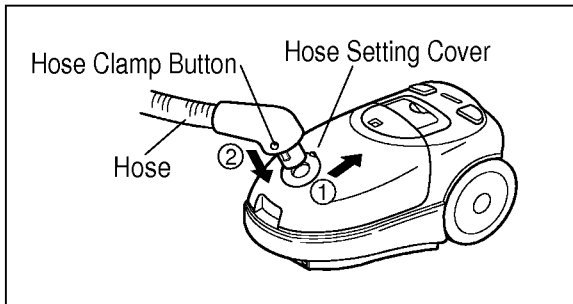

### 5. Plug connector

- Plug the cord into an outlet located near the floor.

### 6. Power control switch

- Adjusting power control select the power control switch in the handle to choose such floor, carpet, sofa, curtain.

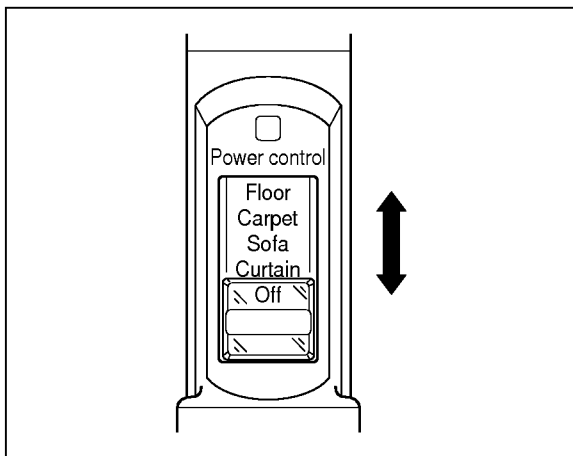

### 7. Pull out the cord from the back of the cleaner and plug into the receptacle.

- Excessive pulling out may cause problems with the reel.

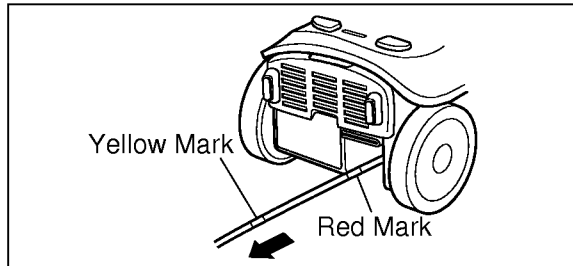

8. Pass the nozzle lightly over the floor. Do not exert excessive pressure, as this may damage the flooring, particularly parquet floors. Best results will be obtained by applying only light pressure. If the suction power weakened, raise the front end slightly, as shown in the illustration.

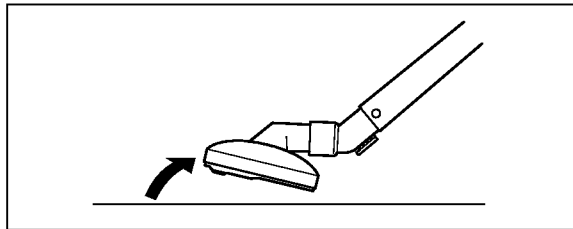

### DUST INDICATOR

- GREEN :Continue to use
- RED : Empty the filter bag. Filter bag is full
- Watch the dust indicator after detaching the nozzle 10cm from the floor.

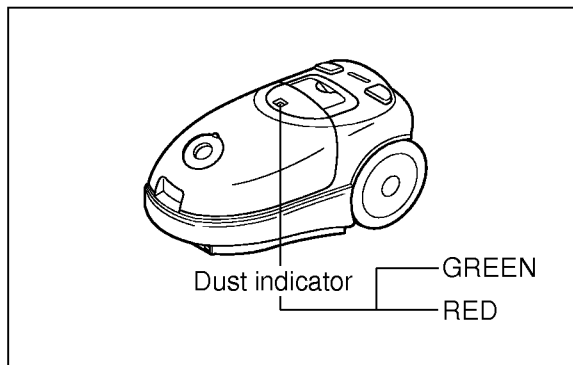

## CHANGE THE CLOTH FILTER BAG

1. Push the setting button, and then lift the filter cover.

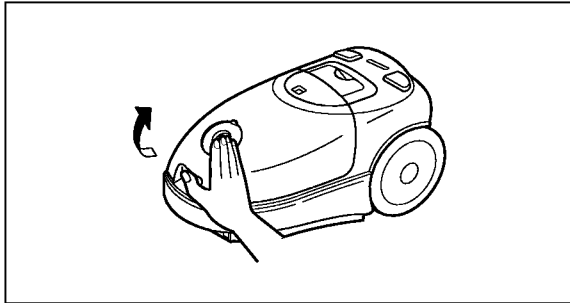

2. Take out the cloth filter bag

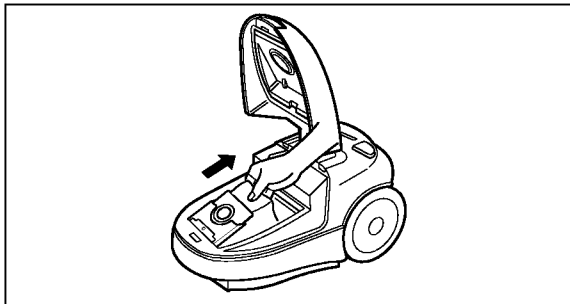

3. Slide the clip off and empty the cloth filter bag.

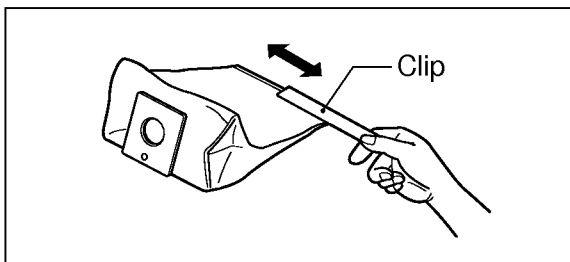

## CLEAN FILTER CLEANING

- Pull out clean filter and clean as shown.

1. Pull out clean filter.

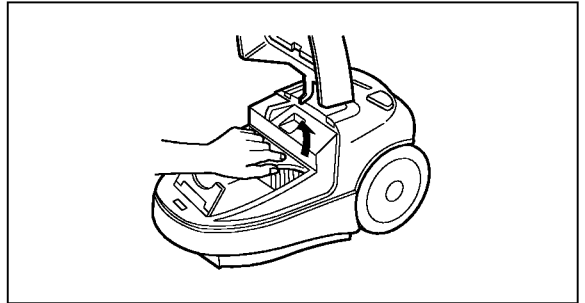

2. Brush up dust and wash filter in a warm soapy water. Do not clean in a dish washer or in a washing machine.

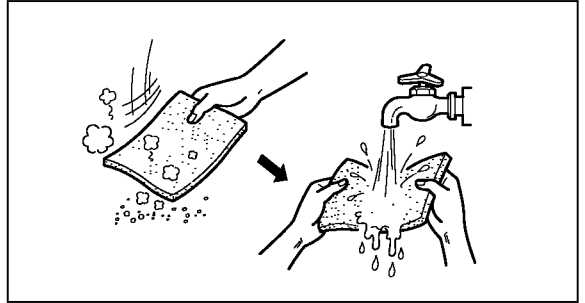

3. Remove the moisture.

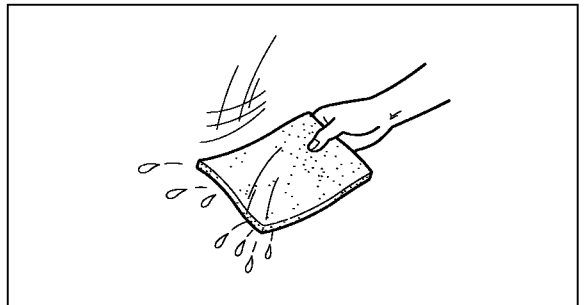

4. Dry the clean filter sufficiently in shade for about a day

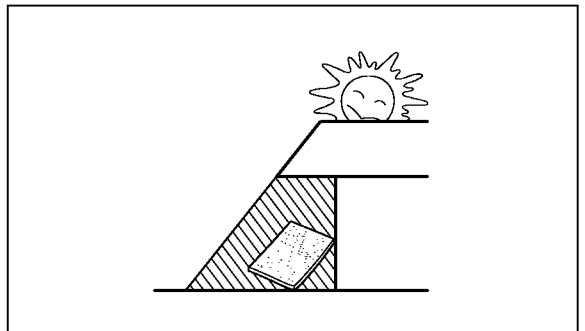



## MICRO FILTER REPLACEMENT

1. Open the rear cover

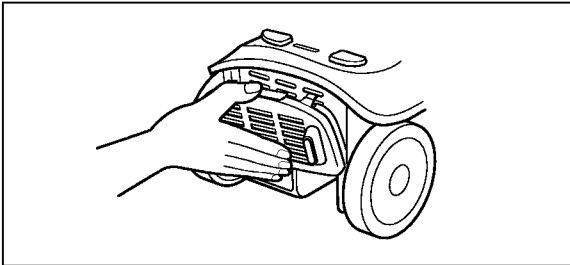

2. Replace the old micro filter with the new micro filter. Be sure to fit the guide rib of the rear cover and the holes of micro filter.

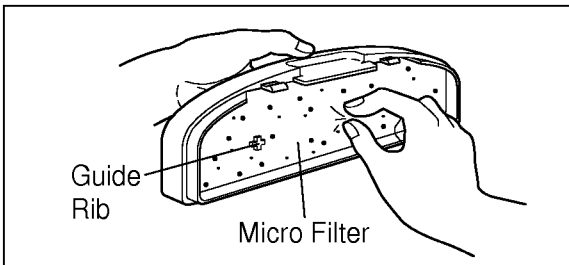

## AFTER CLEANING

1. Unplug the cord from the wall outlet. Press the cord reel button and wind the cord.

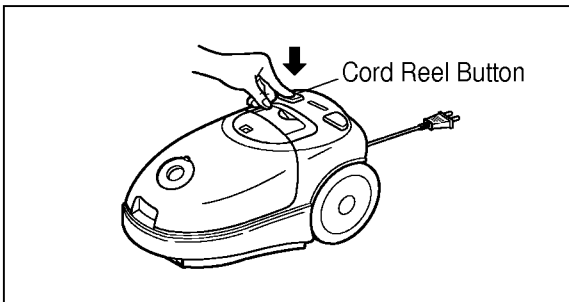

2. When not in use, you can attach the hose and the wand to the bottom of the cleaner in upright position. Push the holder into the holder slot on the bottom of the cleaner. (Fig 1)

Also you can store the hose and the wand in horizontal position.

Push the nozzle hook on the floor nozzle into the holder slot on the left of the cleaner body cover (Fig 2)

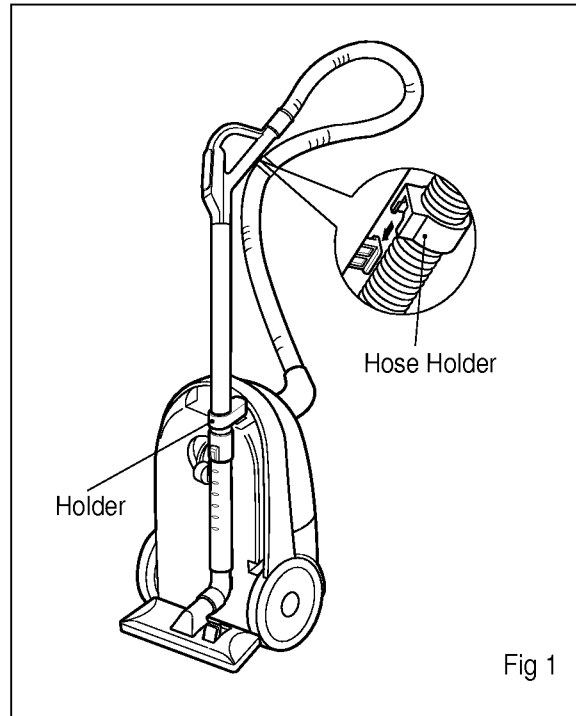

Fig 1

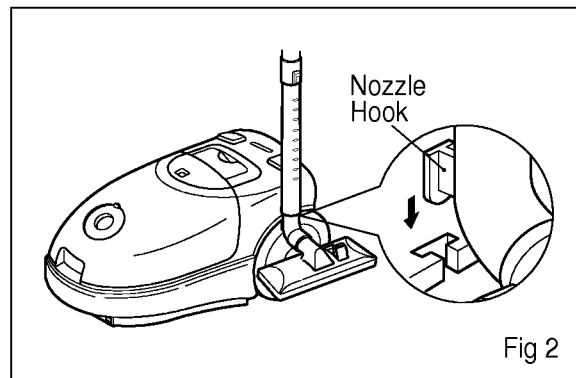
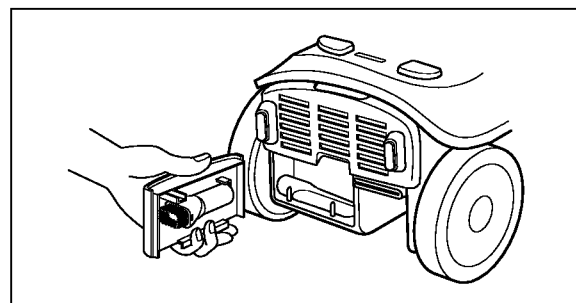

Fig 2

## ATTACHMENTS STORING

- To use crevice tool or dust brush, open the accessory cover on the back of the cleaner and take it out.



## BEFORE REQUESTING SERVICE

Other than cleaning mentioned in this instruction manual, no additional maintenance or servicing of this appliance is required. The motor is permanently lubricated and will require no oil.

Repairs, when necessary, must be performed at an authorized service facilities. This appliance is intended for HOUSEHOLD USE ONLY and not for commercial or industrial use.

## TROUBLE SHOOTING CHART

Review this chart to find do-it-yourself solutions for minor performance problems.

**WARNING :** Disconnect power supply before servicing and/or cleaning the unit as electrical shock could occur and/or cleaner could suddenly start.

Problem	Possible Cause	Possible solution
Cleaner won't run	<ol style="list-style-type: none"> <li>1. Unplugged at wall outlet.</li> <li>2. Power control S/W is in "OFF" position.</li> </ol>	<ol style="list-style-type: none"> <li>1. Plug in firmly</li> <li>2. Push switch button.</li> <li>3. Regulate power control switch.</li> </ol>
Poor suction for dirt pick-up	<ol style="list-style-type: none"> <li>1. Full or clogged filter bag.</li> <li>2. Clogged clean filter.</li> <li>3. Worn carper/floor nozzle brush.</li> <li>4. Hole in hose.</li> <li>5. Clogged carpet/floor nozzle.</li> <li>6. Canister filter cover open.</li> </ol>	<ol style="list-style-type: none"> <li>1. Change the filter bag.</li> <li>2. Change the clean filter.</li> <li>3. Change brush.</li> <li>4. Replace hose.</li> <li>5. Clean carpet/floor nozzle air passage.</li> <li>6. Close filter cover.</li> </ol>
Cleaner picks movable rugs-or carpet/floor nozzle pushes too hard	<ol style="list-style-type: none"> <li>1. Suction too strong.</li> </ol>	<ol style="list-style-type: none"> <li>1. Regulate power control switch.</li> </ol>

# SPECIFICATION

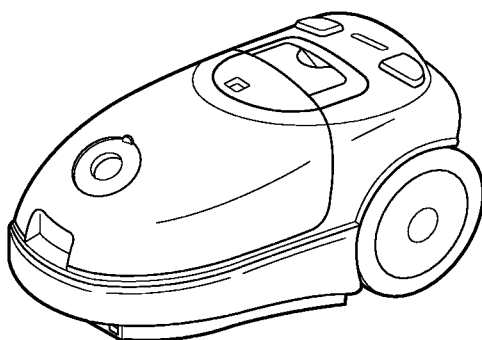

- POWER SOURCE ON THE RATING LABEL
- CAPACITY : 2.6ℓ
- CORD LENGTH : 6m
- NET WEIGHT : 8.1kg
- NET DIMENSIONS (W × L × H) : 265 × 435 × 220(mm)
- PACKING DIMENSIONS (W × L × H) : 314 × 489 × 365(mm)
- ACCESSORIES
  - Hose ..... 1
  - Extension wand ASM ..... 1
  - Carpet pedal tool ASM ..... 1
  - Crevice tool..... 1
  - Cloth filter bag ..... 1
  - Dusting brush ..... 1

\* These specification are subject to change according to the agent/buyer's request.

<p>THE SERIAL NUMBER IS FOUND ON THE BOTTOM OF THIS UNIT. THIS NUMBER IS UNIQUE TO THIS UNIT AND NOT AVAILABLE TO OTHERS YOU SHOULD RECORD REQUESTED INFORMATION HERE AND RETAIN THIS GUIDE AS A PERMANENT RECORD OF YOUR PURCHASE.</p>	<p>DATE OF PURCHASE _____</p> <p>DEALER PURCHASED FROM _____</p> <p>DEALER ADDRESS _____</p> <p>DEALER PHONE NO. _____</p> <p>MODEL NO. _____</p> <p>SERIAL NO. _____</p>
---	---



P/NO: 3874Fi3366M

MADE IN KOREA