



Please read this manual carefully before operating your set.
Retain it for future reference.
Record model number and serial number of the set.
See the label attached on the bottom of the set and quote this information to your dealer when you require service.

Model number :
Serial number :

LG LCD PROJECTOR



LCD PROJECTOR



CONTENTS

INTRODUCTION	Safety Instructions	3
	Names of parts	7
INSTALLATION AND CONNECTION	Installation and Connection	11
	Connecting to a Desktop PC	15
	Connecting to a Notebook PC	16
	Connecting to a Macintosh Desktop PC	17
	Connecting to a Macintosh PowerBook	20
	Connecting to a Video Source	21
BASIC FUNCTIONS	Turning on the Projector	22
	Operating the Projector	23
	Function checking	25
	Selecting source mode	26
	Using Still function	27
SPECIAL FUNCTIONS	Selecting language	28
	Using Flip Horizontal / Vertical function	29
	Using Blank function	31
	Checking lamp time	33
	Selecting PC screen size input signal	34
POSITIONING	Adjusting screen display	35
	Using Resize function	37
VIDEO/ TRACKING	Adjusting Video	38
	Using Tracking function	39
INFORMATION	Supported Monitor Display	41
	Maintenance	42
	Specifications	44

Before operating the unit, please read this manual carefully.

▶ Always keep the safety instructions to prevent any potential accident or misuse of the projector.

▶ Safety Instructions have two kinds of information, and each meaning of it is as below.

 **WARNING** The violation of this instruction may cause serious injuries and even death.

 **NOTES** The violation of this instruction may cause light injuries or damage of the projector.

* The meanings of symbols in the manual and the unit are as below.

▶  Take care of danger that may happen under specific condition.

▶  Take care of electric shock that may happen under specific condition.

▶ After reading this manual, keep it in the place that the user always can contact easily.

Do not attempt to repair or adjust this equipment. Contact your dealer or Service center. High risk of electric shock!

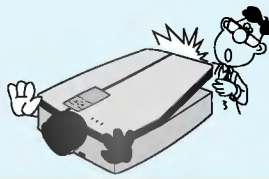

Do not place anything containing liquid on top of the projector. High risk of Electric Shock or damage to the projector.

This may cause a fire or could give an electric shock.

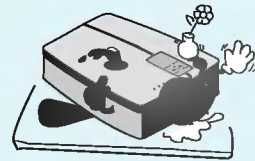

Don't insert any object into the exhaust vent .

This may cause a fire or could give an electric shock.



Don't place the projector in direct sunlight or near a heat source(radiator or heater).

This may cause a fire or could give an electric shock.

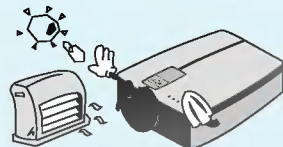

Don't remove any covers (except lens cover). High risk of Electric Shock!

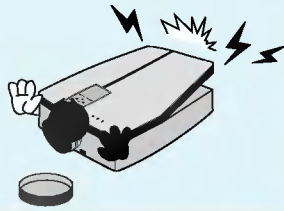

Use an air spray or soft cloth that is wet with a neutral detergent and water for removing dust or stains on the projection lens.

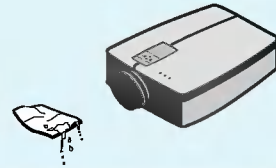

Only use the correct type of batteries for the remote control. Dispose of used batteries carefully.

This may cause a fire or could give an electric shock.

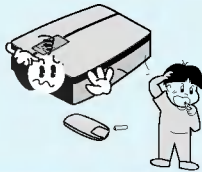

Don't look directly onto the lens when the projector is in use. Eye damage may occur!

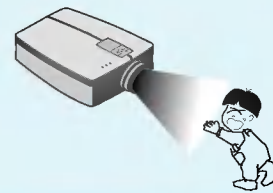

Don't use the projector in damp place such as a bathroom or any place where it is likely to get wet. Serious damage could occur or risk of Electric Shock!

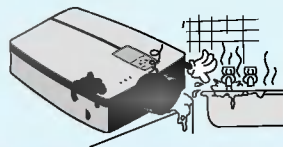

Don't use the projector if there is smoke or unusual smell from the projector. Disconnect from the mains and contact the service center. Risk of fire!

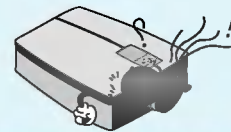

Don't look at laser beam directly as it may cause eye damage.



Only use the projector on a level and stable surface.

It may fall down or be upset.



Don't cover the project when in use.

It makes internal temperature increase and causes a fire.

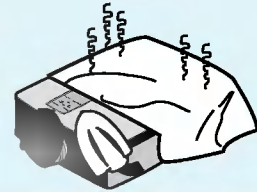

Disconnect from the mains and remove all connections before moving.

Damage of cords may cause a fire or electric shock.

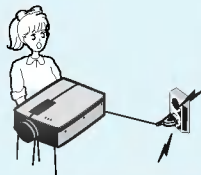

Ensure the projector is connected to the nearest mains socket to prevent the mains lead from being stretched.

Loose connection may cause fire.



Never touch the power plug with wet hand.

It may cause electric shock.

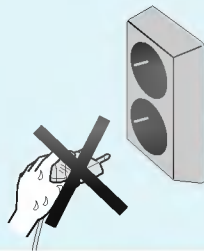

Don't use alcohol, benzene, or thinners to clean any plastic parts of the projector. Never use industrial chemicals or detergents.

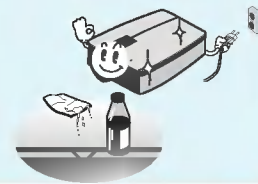

Ensure the power lead doesn't trail across any hot objects like a heater.

It may make covering parts melted and cause a fire or electric shock.

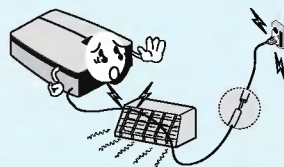

When disconnecting from the mains don't pull the mains lead as this may damage the lead internally.

If you hold the cord when unplugging, the internal line of the cord may be cut. This may cause heating and a fire.

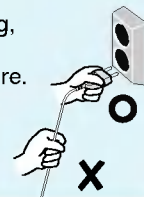

Don't touch the lens of the projector. It may cause damage of it.

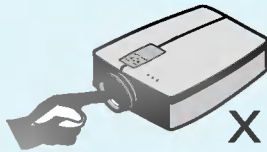

Don't use any sharp tools on the projector as this will damage the casing.

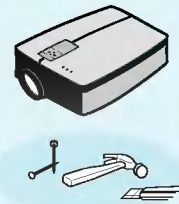

If the projector requires cleaning inside contact the service centre. Accumulated dust can cause mechanical failure.



Place the projector where people will not trip or tread on the power lead.

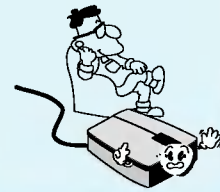

Use the indicated type of power source on the projector. If you are not sure of the type of power available, consult your dealer or customer service center.

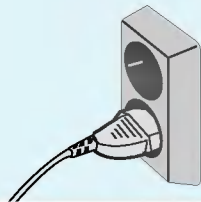

Don't place the projector or the remote control on a heater or use in a heated car.

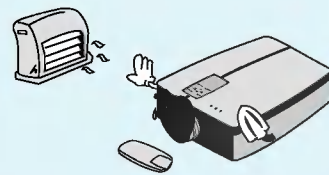

Don't use the projector when the power cord or the plug is damaged or the connecting part of wall socket is loose.

It may cause electric shock or a fire.



Be sure to unplug when you don't use the projector for a long period or you are absent.

Accumulated dust may cause a fire, electric shock from deterioration, or electric leakage.

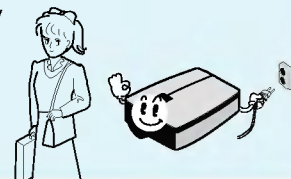



Main Body

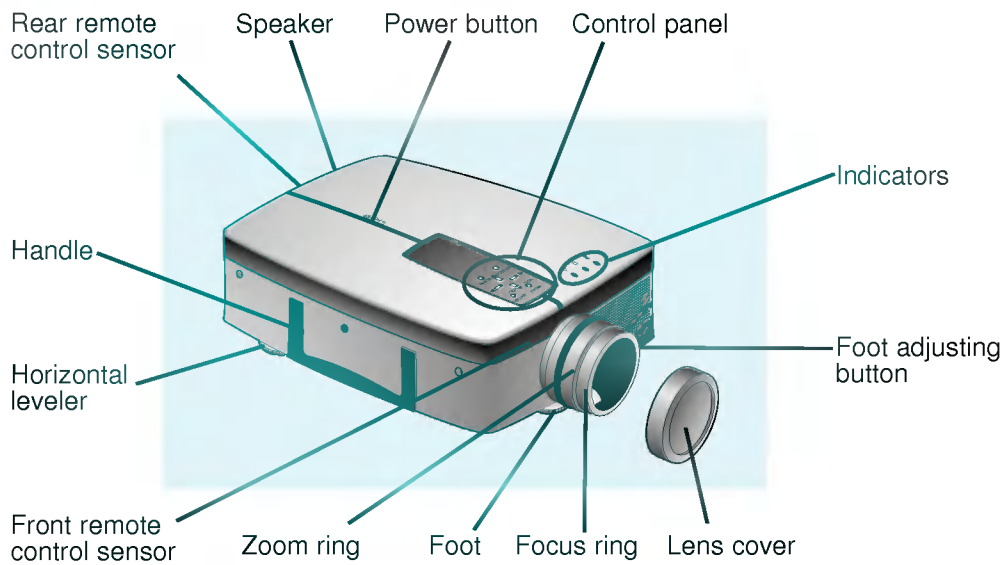

Rear Connecting Part

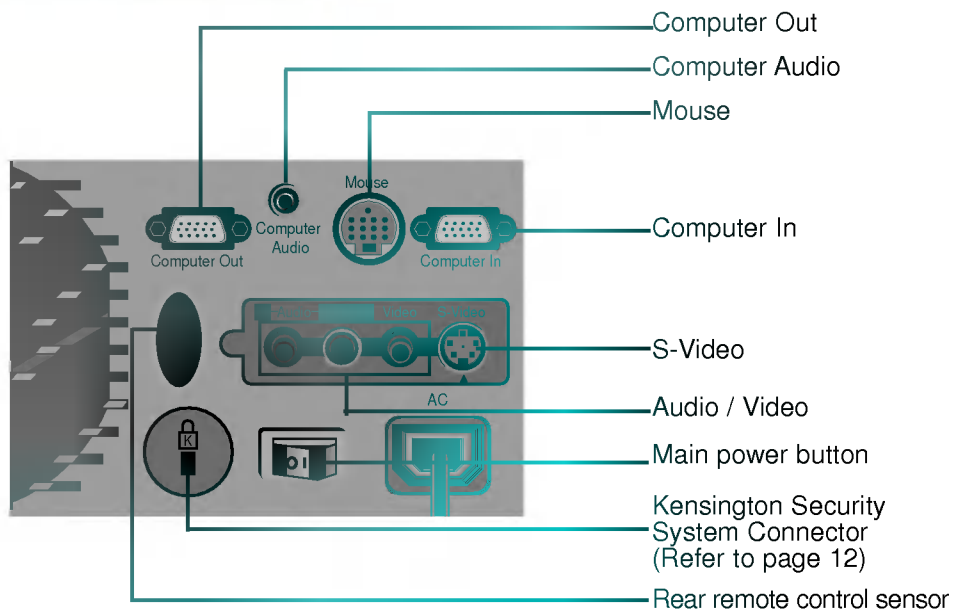

Control Panel

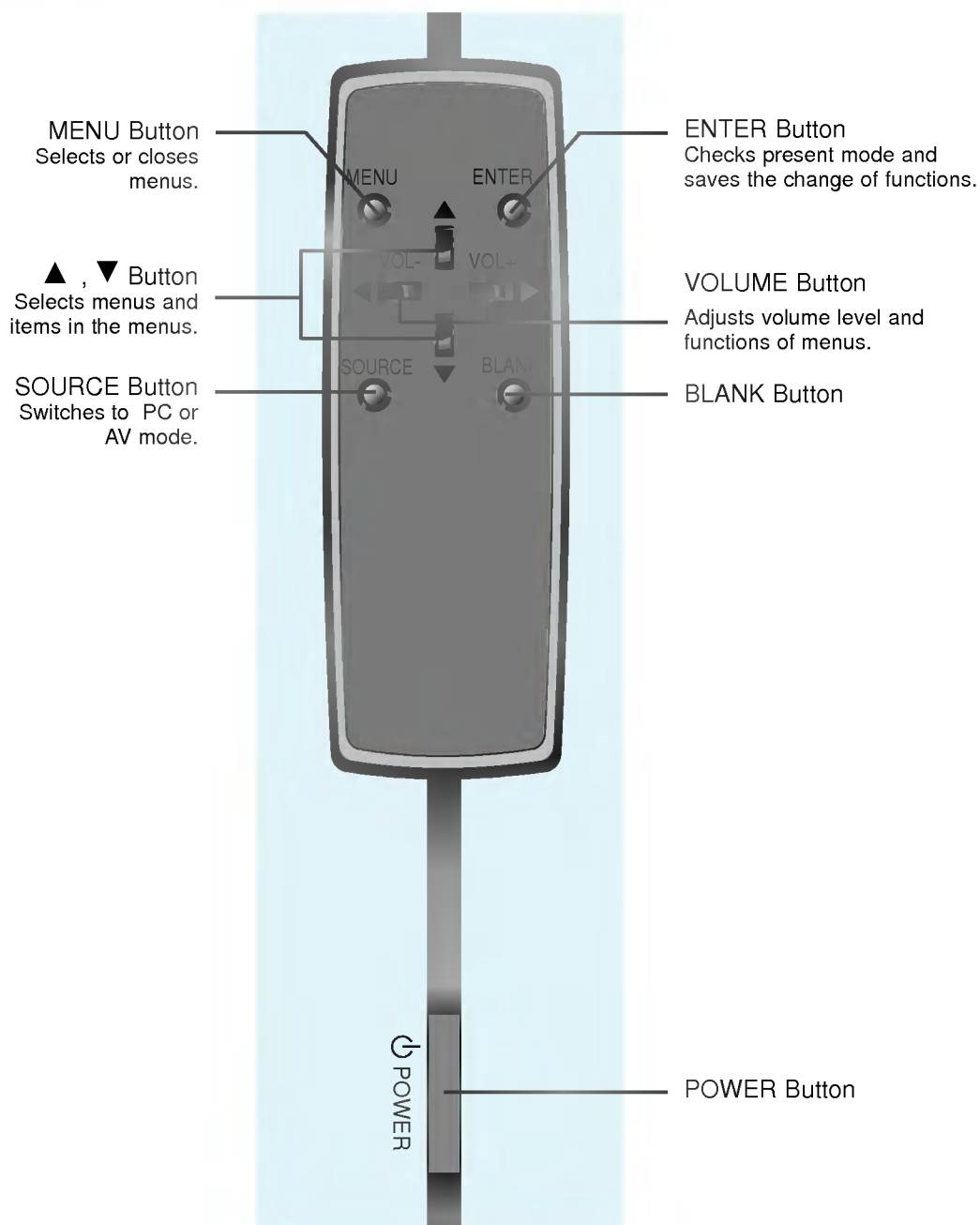

Remote Control

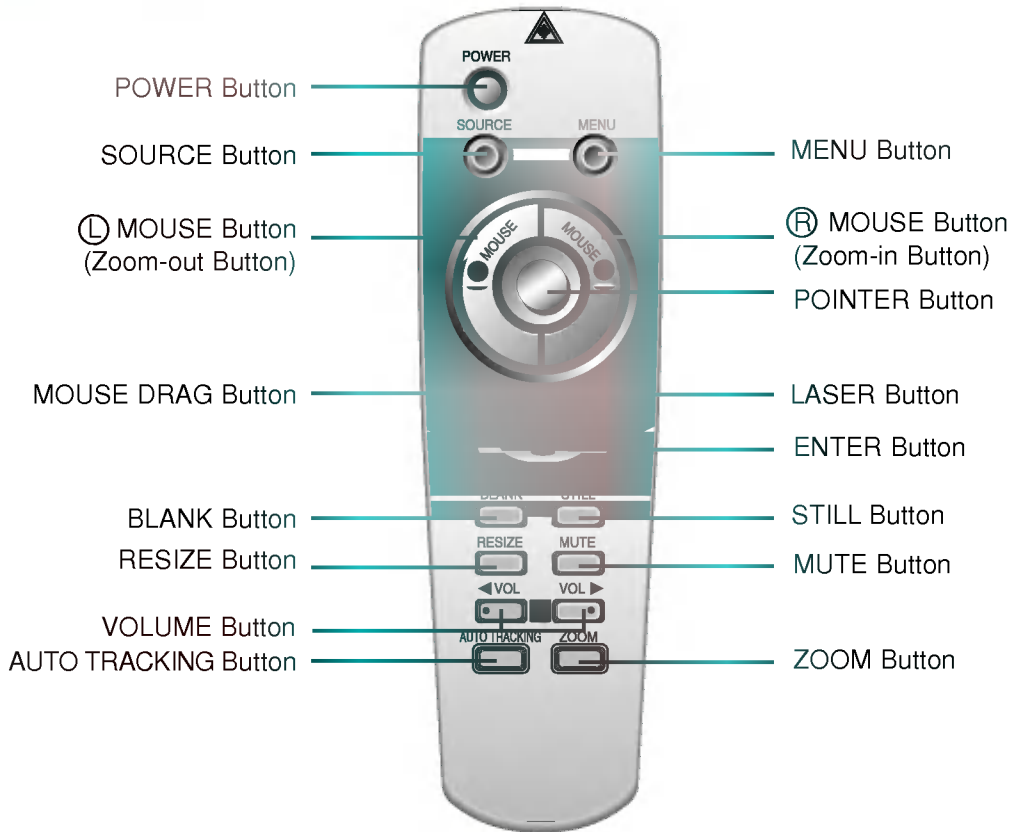

Inserting the batteries

- 1 Slide the battery cover in the direction of the arrow to remove.

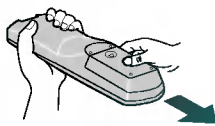

- 2 Insert the batteries with correct polarity.

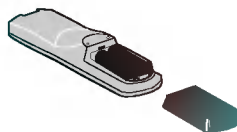

- 3 Replace the battery compartment cover to the arrow direction.

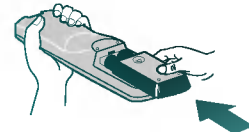

Functions on the Remote Control

Button	Function
POWER Button	Selects ON/OFF of power.
SOURCE Button	Switches to PC or AV mode.
MENU Button	Displays or hides the menu.
Ⓛ MOUSE Button (Zoom-out Button)	<ul style="list-style-type: none"> * Corresponds to the Left - Click of PC Mouse. This button registers a menu selection and selects other custom functions. * Downsizes the screen on the zoom function.
Ⓡ MOUSE Button (Zoom-in Button)	<ul style="list-style-type: none"> * Corresponds to the Right - Click of PC Mouse. This button registers a menu selection and selects other custom functions. * Enlarges the screen size on zoom function.
POINTER Button	<ul style="list-style-type: none"> * After selecting menus, controls selecting and adjusting functions with the direction of up, down, left, right. * Moves the screen with the direction of up, down, left, right on zoom function. * Moves and releases the selected icon on PC screen.
MOUSE DRAG Button	Uses to select and drag an icon in PC mode.
ENTER Button	Checks the present mode and saves the change of functions.
ZOOM Button	Refer to page 36.
RESIZE Button	Refer to page 37.
AUTO TRACKING Button	Refer to page 39~40.
BLANK Button	Refer to page 31~32.
STILL Button	Refer to page 27.
MUTE Button	Cuts off audio.
VOLUME Button	Adjusts volume level.
LASER Button	Makes a bright red laser point on the screen for attention. (Don't look at laser beam directly as it causes eye damage.)

Accessories

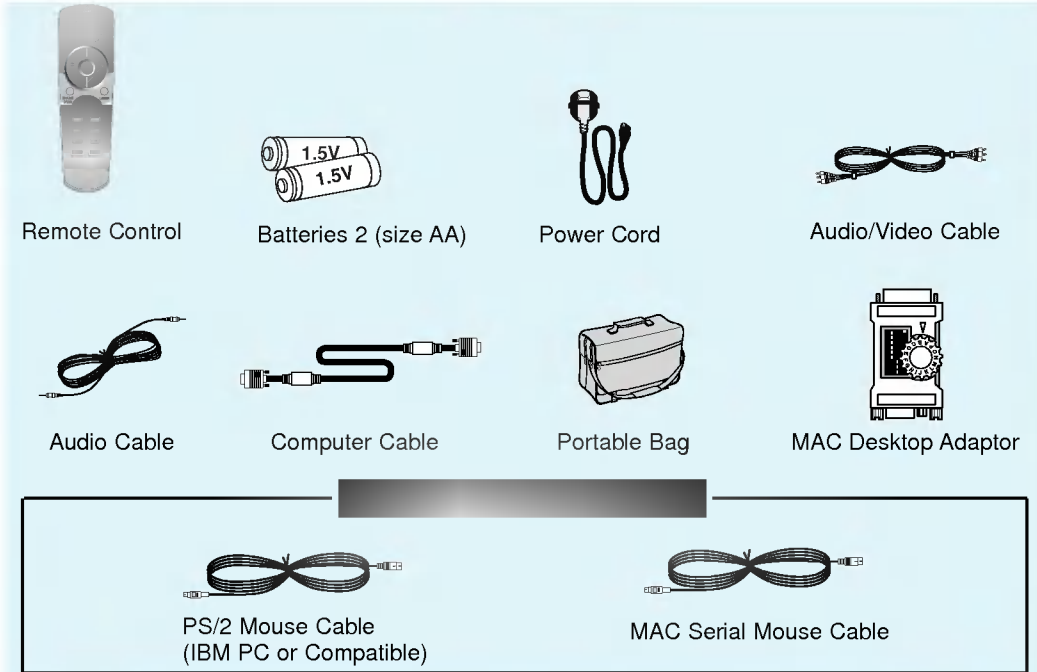

Optional Extras

- * Contact your dealer for buying these items.
- * When applying a ceiling installer, use only the ceiling installer for LCD projector.
- * Contact your dealer for replacing a new lamp.

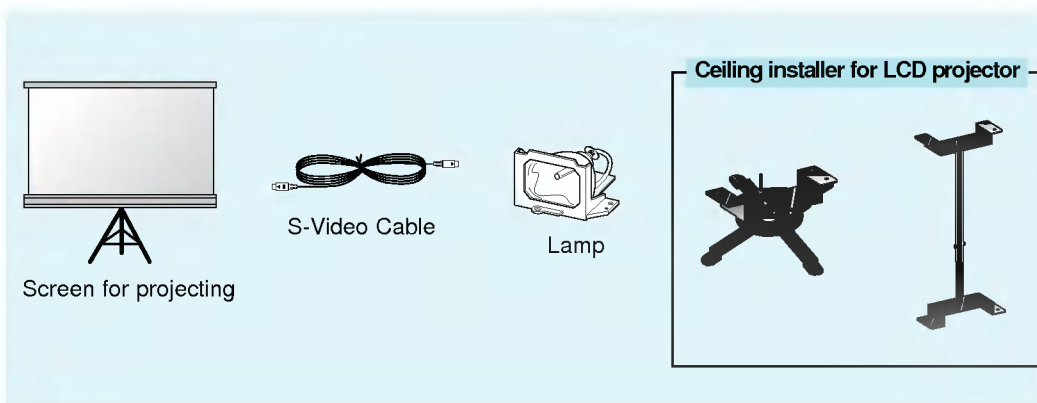

Using Kensington Security System

- The projector has Kensington Security System Connector on the back panel. Connect the Kensington Security system cable as below.
- For the detailed installation and use of the Kensington Security System, refer to the user's guide attached to the Kensington Security System set. And for further information, contact <http://www.kensington.com>, the internet homepage of the Kensington company that deals with expensive electronic equipments such as notebook PCs or LCD projectors.
- Kensington Security System is an optional item.

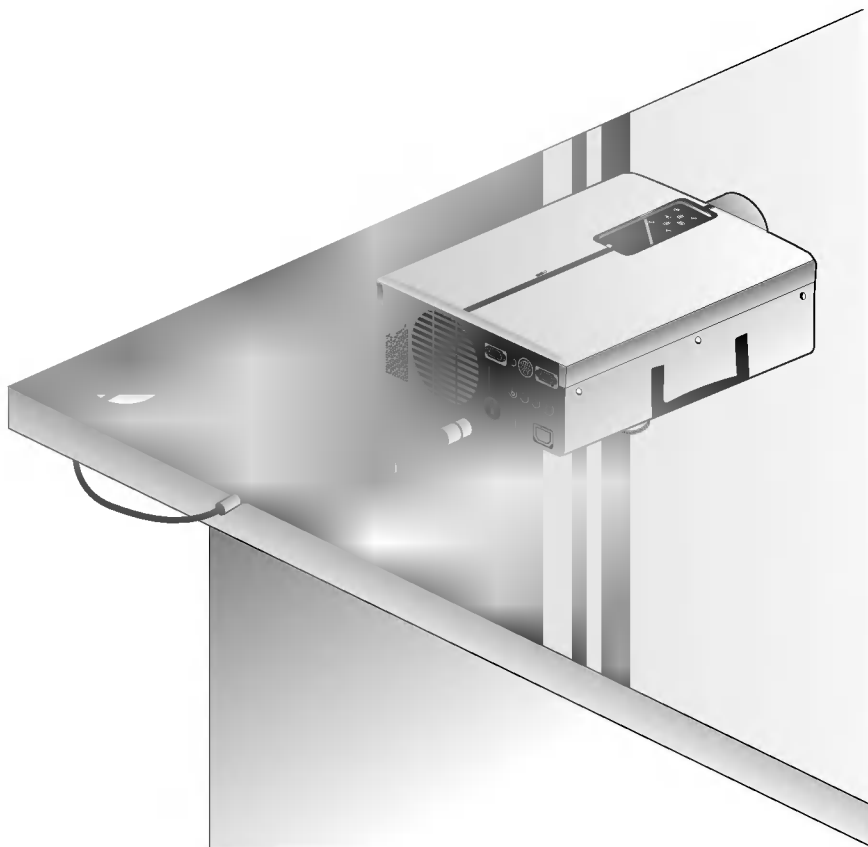

Projector Status Indicators

* Lamp Indicator, operation indicator and temperature indicator at the top of the projector show the user the operating status of the projector.

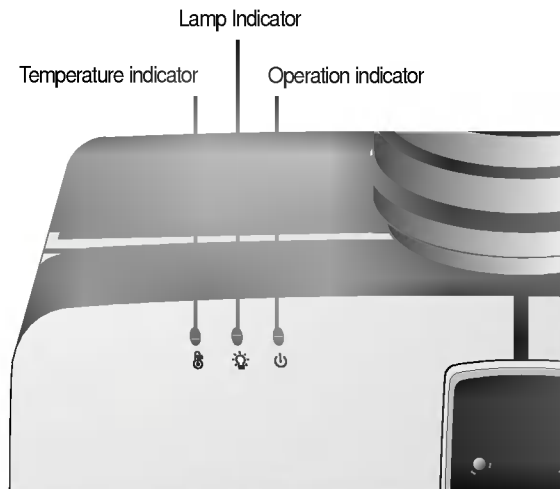

Operation Indicator	Orange	Standby.
	Green	On operation.
	Off	Power off.
Lamp Indicator	Orange	Projection lamp is reaching the end of its life and needs to be replaced with a new lamp.(over 1400 hours) "Replace the Lamp"
	Red	Projection lamp has reached the end of its life and cannot project images any longer. Replace the lamp with a new one. (over 1500 hours)
	Red(flashing)	The projector has trouble in the lamp or around it. Contact the service center.
	Green(flashing)	The lamp cover is not closed.
Temperature Indicator	Orange	This projector is in high temperature. If you don't turn off the projector, it'll be turned off automatically. "Temperature is Too High"
	Red	The projector is turned off as its high temperature.
	Red (flashing)	Power is turned off as the trouble of internal cooling fan. Contact your service center.

" " is the warning message on screen.

Basic Operation of the Projector

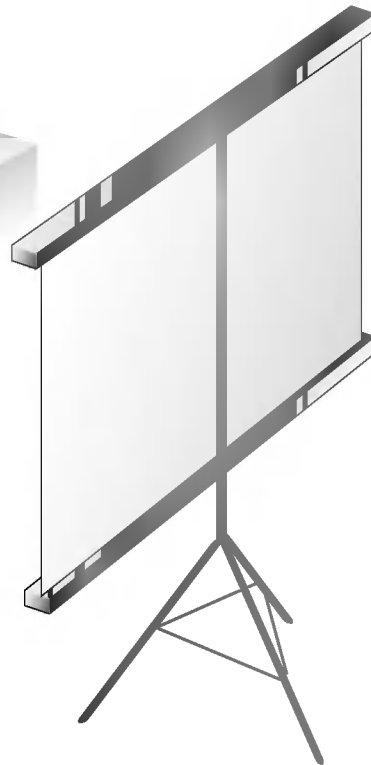
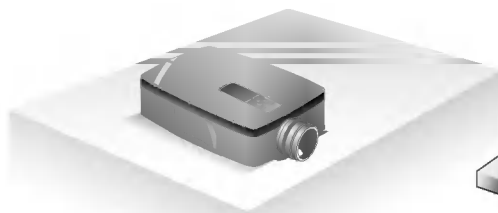

1. Place the projector on a sturdy and horizontal surface with the PC or AV source.
2. Place the projector in the correct distance from the screen. The distance between the projector and the screen determines the actual size of the image.

Screen size	Horizontal distance from projector to screen
610x460cm(300inch)	12.55m~16.35m
410x300cm(200inch)	8.35m~10.87m
200x150cm(100inch)	4.16m~5.42m
160x120cm(70inch)	2.90m~3.78m
120x90cm(50inch)	2.06m~2.69m
81x61cm(40inch)	1.64m~2.15m

3. Turn the projector so that the lens can be at a right angle to the screen. If the projector is not at a right angle, the screen image will be crooked. At this time perform keystone function. (Refer to page 35.)
4. Connect the cables of the projector to a wall power socket and other connected sources.

- * You can connect the projector to a computer of VGA, SVGA, XGA and SXGA output.
- * You can use resize function for VGA, SVGA output.
- * Refer to page 41 for the projector supported monitor display.

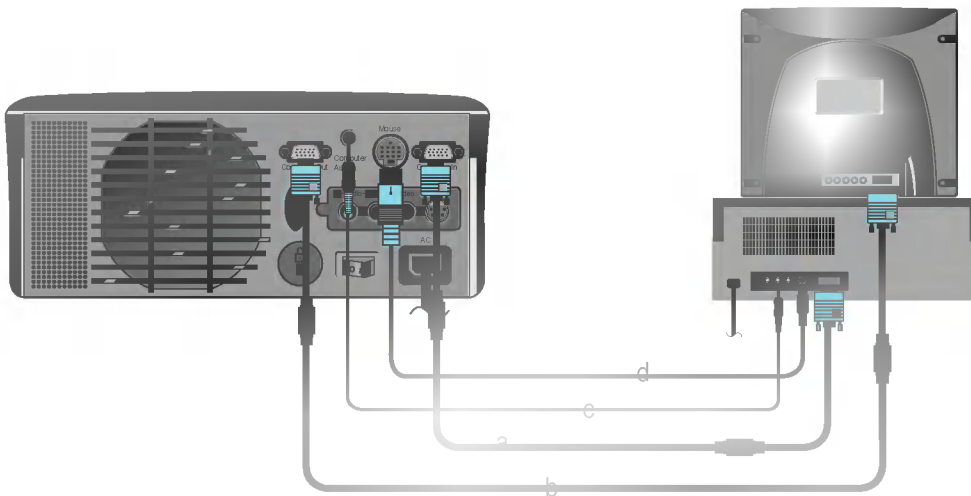

< How to connect >

- a. Connect either end of the computer cable to **Computer In** of the projector.
- b. Connect the monitor cable from the PC monitor to **Computer Out** of the projector if you want to see the projected image on PC monitor.
- c. Connect the audio cable from the PC (LINE OUT sound port) to **Computer Audio** of the projector.
* If the PC has two audio out ports of SPEAKER OUT and LINE OUT, connect the LINE OUT port to get better sound quality.
- d. Connect the PS/2 mouse(for IBM PC or compatible) cable(6 pin) to the **Mouse** of the projector.

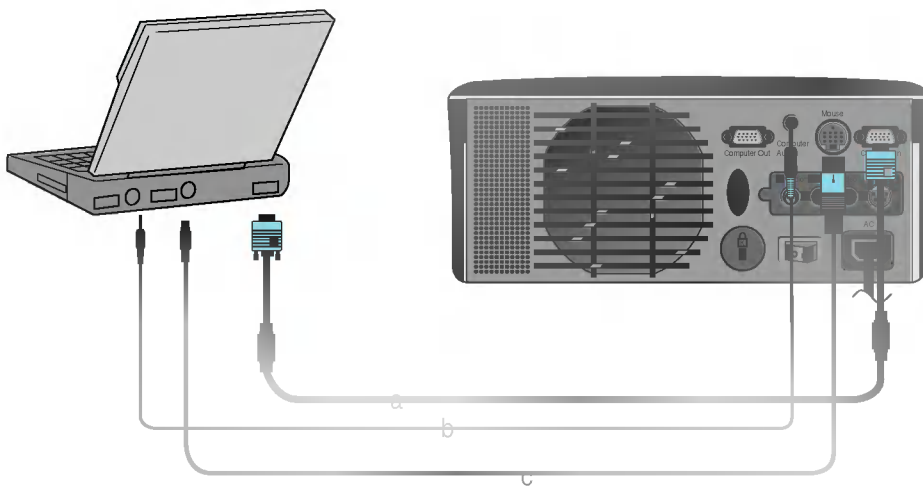

< How to connect >

- a. Connect either end of the computer cable to **Computer In** of the projector.
- b. Connect the audio cable from the PC to **Computer Audio** of the projector.
- c. Connect the PS/2 mouse(for IBM PC or compatible) cable(6 pin) to the **Mouse** of the projector.

* You must use the Macintosh desktop adaptor to connect the projector to a Macintosh PC.

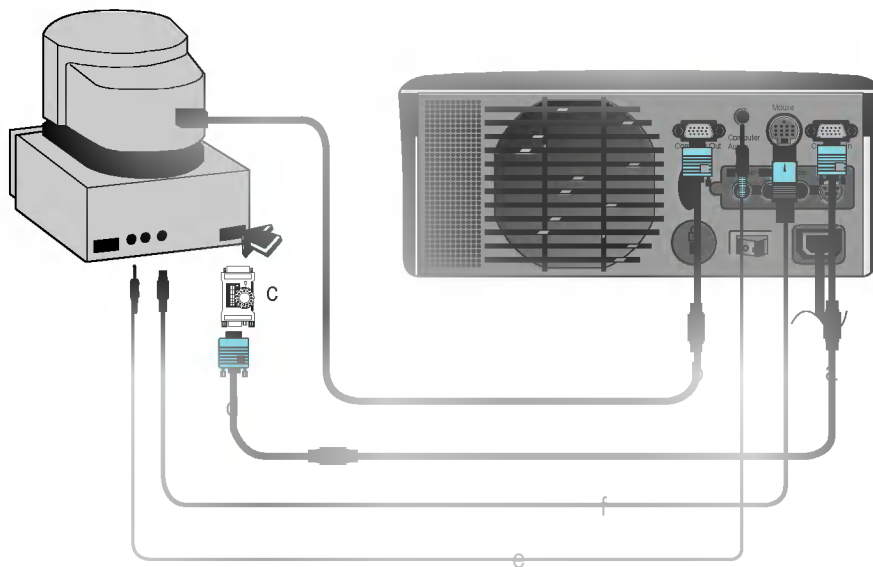

< How to connect >

- a. Connect either end of the computer cable to **Computer In** of the projector.
- b. Connect the monitor cable from the Macintosh monitor to **Computer Out** of the projector if you want to see the projected image on Macintosh monitor.
- c. Set the adjusting number and letter of the Macintosh desktop adaptor in accordance with the resolution you want to use and connect the adaptor to the Macintosh. (Refer to page 18 ~ 19)
- d. Connect the computer cable to the Macintosh desktop adaptor.
- e. Connect the audio cable from the PC to **Computer Audio** of the projector.
- f. Connect the mouse cable(4 pin) from the Macintosh mouse port to the **Mouse** of the projector.

How to use the Macintosh desktop adaptor

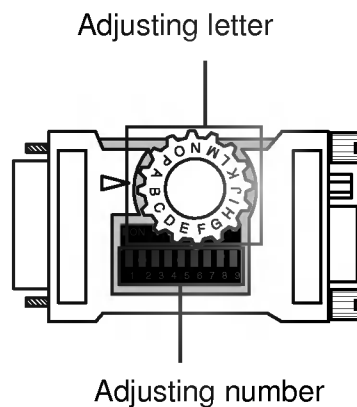

- a. **How to use**
Usually set 1 ~ 6 to OFF status and 7 ~ 9 to ON status of the adjusting numbers. And select the adjusting letter which is correct to the Macintosh and the monitor. (Refer to page 19.)
- b. **Notes for Connecting to the Macintosh PowerBook**
If you get problems when connecting it to the projector, set the adjusting number 9 to OFF status and restart the Macintosh PowerBook.

Adjusting letters of MAC desktop adaptor in accordance with kinds of MAC and output spec.

MAC S	output spec	12xRGB 512x288 24.5 60	13x14xRGB 640x480 25 66	15xPortrait 640x470 68.9 75	VGA 640x480 31 60	SVGA 800x600 35 56	SVGA 800x600 56 or 72	16xColor 832x624 50 75	19xColor 1152x768 60 75	19xColor 1024x768 60 or 70	21xPage Mono 1152x870 65.7 75	21xColor 1152x870 65.7 75	NTSC 15.7 60	FAL 16 50
	output resolution horizontal frequency(KHz) vertical frequency(Hz)	adjusting letter												
MAC G, I, I, I		N	J	O	G	G	G	F	D	G	M	P	L	H
MAC M, I, I, I		N	J		G									
LC		N	J		M									
LCII		N	J		G									
LCIII		N	J	O	G			F						
LC475, LC560		N	J	O	G	G		F						
LC575		N	J	O	G	G		F	D		M	P	L	H
Performa 400,405,410,430,600,800CD		N	J		G									
450		N	J	O	G			F						
Quadra														
700,900		N	J	O	G	G		F			M	P	L	H
605,610,650,800,950		N	J	O	G	G		F	D		M	P	L	H
840AV		N	J	O	G	G	G	F	D	G	M	P	L	H
Centris														
610,650		N	J	O	G	G		F	D		M	P	L	H
660AV		N	J	O	G	G	G	F	D	G	M	P	L	H
PowerBook 160,165G,180,190C		N	J	O	G	G		F						
DUO DOG, MINI, DOC		N	J	O	G	G		F						
824 BOARD		N	J	O				F			M	P	L	H

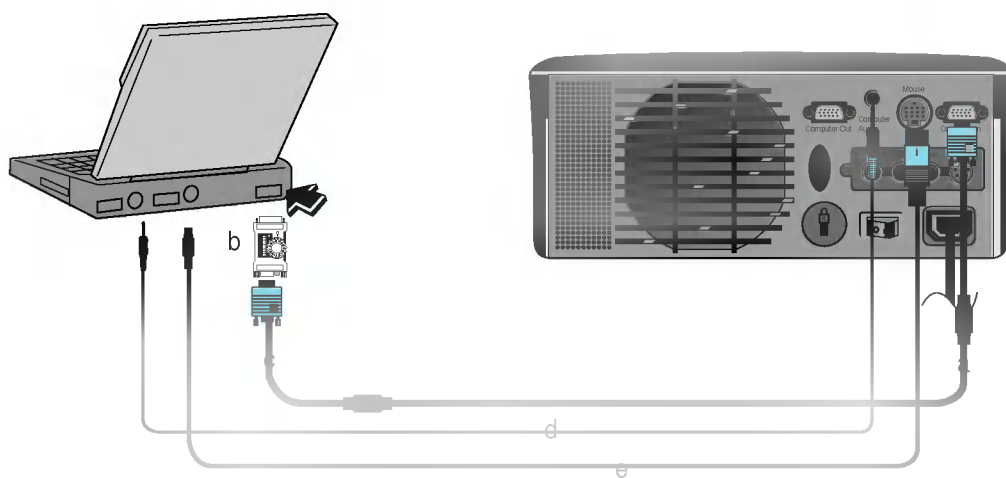

< How to connect >

- a. Connect either end of the computer cable to **Computer In** of the projector.
- b. Set the adjusting number and letter of the Macintosh desktop adaptor in accordance with the resolution you want to use and connect the adaptor to the Macintosh PowerBook.(Refer to page 18 ~ 19)
- c. Connect the other end of the computer cable to the Macintosh desktop adaptor.
- d. Connect the audio cable from the PC to **Computer Audio** of the projector.
- e. Connect the mouse cable from the Macintosh mouse port to the **Mouse** of the projector.

* You can connect a VTR, a camcorder, a LDP or any other compatible video image source to the projector.

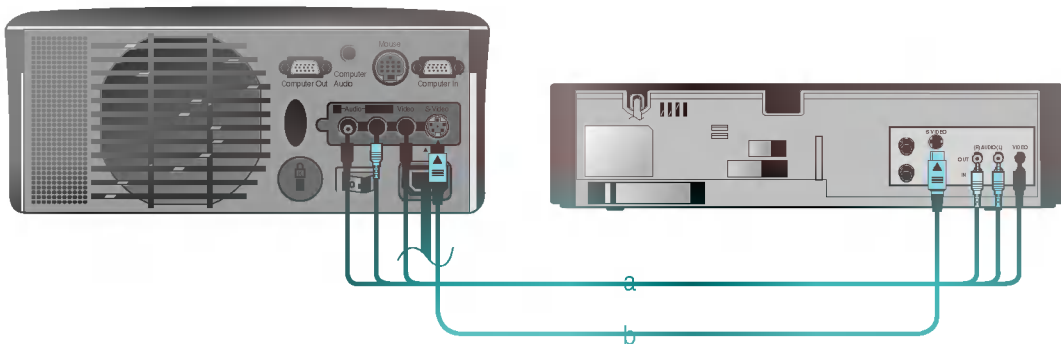

< How to connect 1 >

- a. When connecting the projector to an A/V source, connect the A/V input ports of the projector to the output ports of the A/V source with A/V cables of the same color. The video cable is yellow and the left audio is white and right audio is red.

< How to connect 2 >

- b. Connect S-Video input port of the projector to S-Video output port of A/V source with S-Video cable.
 - * You can get better picture quality when connecting S-Video source to the projector.
 - * If you connect S-Video cable and Video cable simultaneously, you will get only the playing image of S-Video source.
 - * If the Audio output of other external equipments is mono, do connect Audio cable only to the white port(Audio L) of the projector.

1 Remove the lens cover of the projector.

2 Press the main power button on the back panel.

3 Press the **POWER** button on the remote control or top cover. (Green operation indicator flashes during warming up of the lamp.)

- An image appears after the green power indicator is flashed for some time.
 - Select the source mode with the **SOURCE** button.
-

4 Adjust volume level.

- If you press **VOLUME** ► button, sound and volume level number are increased.
- If you press **VOLUME** ◀ button, sound and volume level number are decreased.

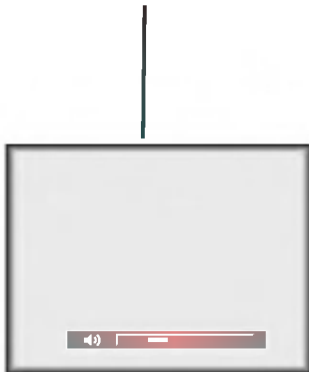

* Don't turn main power off and don't unplug the power cord while the ventilation fan (inlet/outlet) is working.

Focusing and Positioning the Screen Image

When an image appears on the screen, check if it is in proper focus and fits well to the screen.



- To adjust the focus of the image, rotate the focus ring which is the outer ring on the lens.
- To adjust the size of the image, rotate the zoom ring which is the inner ring on the lens.

To raise or lower the image on the screen, extend or retract the foot at the bottom of the projector by pushing foot adjuster button as below.



1. Press the foot adjuster button while you support the other side of the projector. This unlocks the foot and can make it move freely. Take care not to drop the projector.
2. While pressing the foot adjuster button, raise or lower the projector to place the screen image in the proper position.
3. Release the button to lock the foot in its new position.
4. To fine-tune the height of the projector, rotate the front foot to raise or lower it. After raising the front foot, do not press down on the projector.

● If the projector is installed on a place that is not stable or horizontal, the projected screen shape will be distorted.

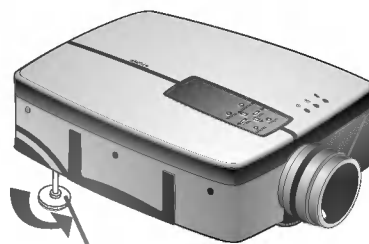

Horizontal leveler

- Adjust the screen shape to be horizontal and rectangular with horizontal leveler as above.

* Without PC or Video signal the OSD doesn't appear.

1 Press the **MENU** button.

2 Move the **POINTER** button up or down to select a menu and press the **ENTER** button. Each time you press the button you can see menus as below.

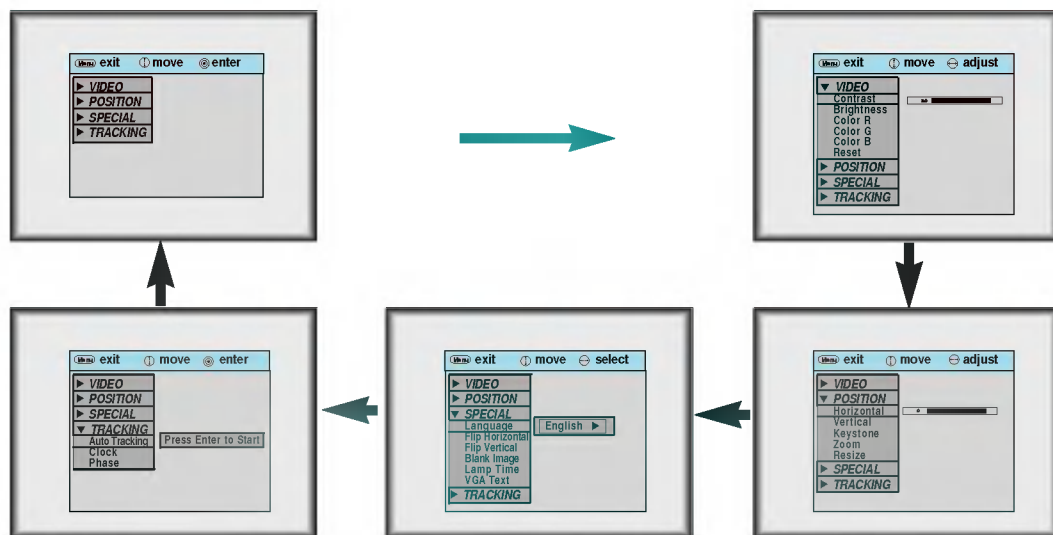

3 Move the **POINTER** button up or down to select a function that you want to use or adjust.

● To finish the menu display, press the **MENU** button repeatedly.

* In AV mode, [Horizontal] / [Vertical] in POSITION menu, [VGA Text] in SPECIAL menu and TRACKING menu are not displayed.

* The sub menus of VIDEO menu in AV mode are different from those in the PC mode. (Refer to page 38).

Selecting source mode

1 Press the **SOURCE** button

2 Each press of the **SOURCE** button changes the display as below.



- 1** Press the **STILL** button.
* You can still the input image from PC or AV source.

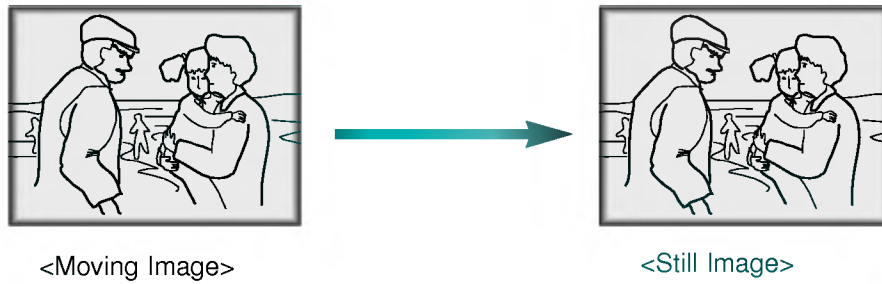

-
- 2** To finish this function, press the **STILL** button again.

- 1** Press the **MENU** button and move the **POINTER** button up or down to select the SPECIAL menu as below.

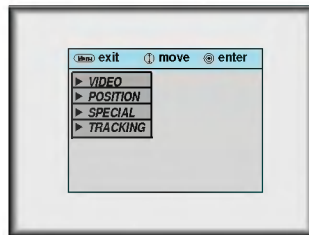

- 2** Press the **ENTER** button and move the **POINTER** button up or down to select [Language] item.

- 3** Move the **POINTER** button left or right to select the language you want to use.
- On-Screen-Display(OSD) is marked in the selected language from this point.
 - To finish menu display, press the **MENU** button repeatedly.

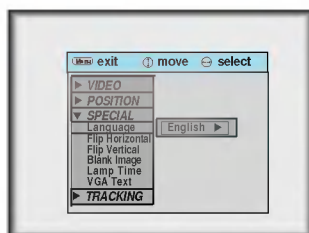

Flip Horizontal Function

* This function reverses the left and the right side of the projected image. Use this function when projecting from behind onto a transparent screen being viewed from the opposite side.

- 1 Press the **MENU** button and move the **POINTER** button up or down to select the SPECIAL menu.



- 2 Press the **ENTER** button and move the **POINTER** button up or down to select [Flip Horizontal] item.

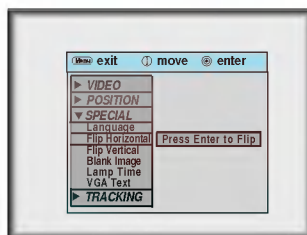

- 3 Press the **ENTER** button to see reversed image.

- Each time you press the button, the image will be reversed.
- To finish menu display, press the **MENU** button repeatedly.

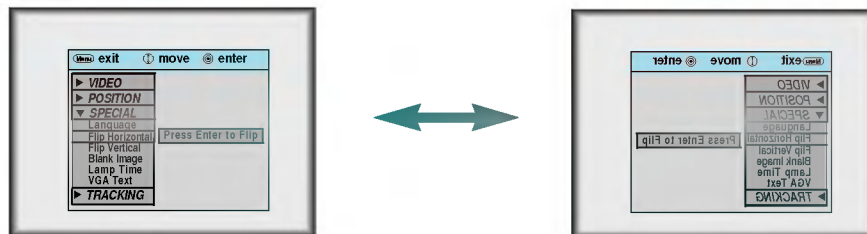

Flip Vertical Function

- * This function reverses the upper and the lower side of the projected image.
- * When you hang the projector upside down from the ceiling for using, you need to reverse all the sides(left, right, upper, lower) of the image.

1 Press the **MENU** button and move the **POINTER** button up or down to select the SPECIAL menu.

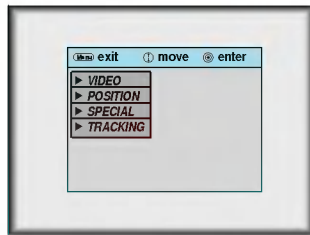

2 Press the **ENTER** button and move the **POINTER** button up or down to select [Flip Vertical] item.

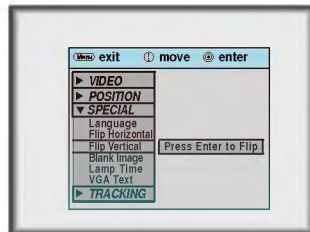

3 Press the **ENTER** button to see reversed image.

- Each time you press the button, the image will be reversed.
- To finish menu display, press the **MENU** button repeatedly.

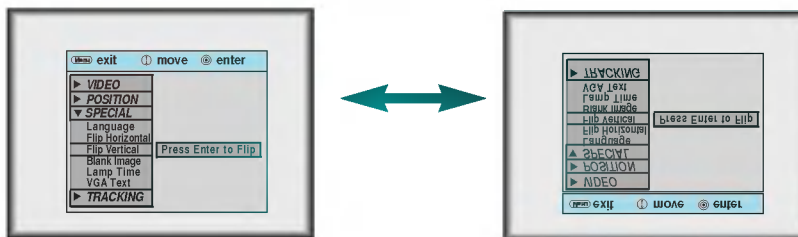

* This function may be effective if you need to get attention of the attendants in meetings or briefings.

1 Press the **BLANK** button.

* The screen turns to be covered with background color and sound becomes off.

* You can choose the background color. Refer to page 32.

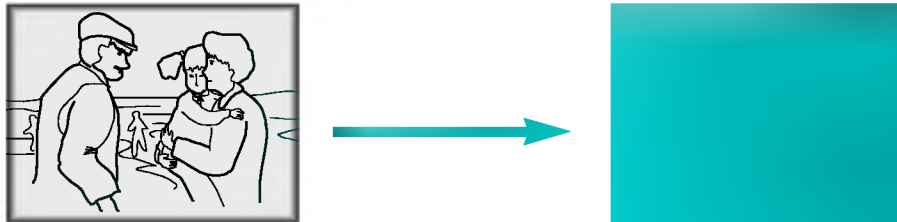

2 To exit the blank status, press the **BLANK** button again.

* If exiting the blank status sound also becomes on.

Selecting Blank Image color

- 1 Press the **MENU** button and move the **POINTER** button up or down to select the SPECIAL menu.

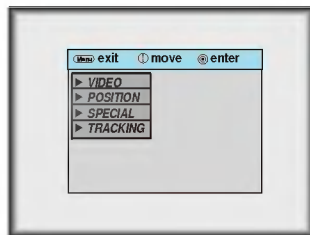

- 2 Press the **ENTER** button and move the **POINTER** button up or down to select the [Blank Image] item.

- 3 Move the **POINTER** button left or right to select the color you want to use.
 - Background color will be changed to the selected color from this point.
 - To exit menu display, press the **MENU** button repeatedly.



- 1** Press the **MENU** button and move the **POINTER** button up or down to select the SPECIAL menu as below.

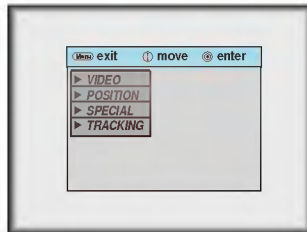

- 2** Press the **ENTER** button and move the **POINTER** button up or down to select the [Lamp Time] item.

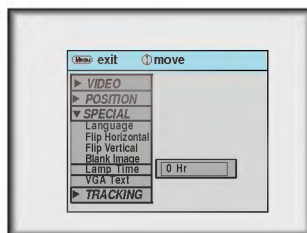

- You can see the used lamp time.
- When the lamp time is reaching 1400 hours, the lamp indicator is turned to orange color.

- * When PC input mode, select the appropriate screen size in SPECIAL menu as below before turning on the PC to get the image size of PC on DOS mode to be fit on the projected screen.
- * In other screen size signals except 640X400 70Hz and 720X400 70Hz, the projected screen sizes are adjusted automatically.

- 1 Press the **MENU** button and move the **POINTER** button up or down to select the SPECIAL menu as below.



- 2 Press the **ENTER** button and move the **POINTER** button up or down to select the [VGA Text] item.

- 3 Move the **POINTER** button left or right to select the screen size you want to use.

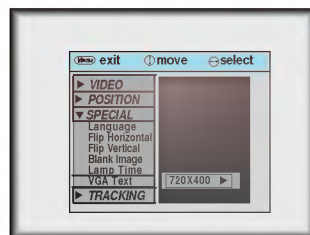

- a. Selecting 720X400
: When input signals are 720X400 70Hz or 640X400 70Hz , the projected screen size is always adjusted to the format of 720X400 70Hz.
- b. Selecting 640 X 400
: When input signals are 720X400 70Hz or 640X400 70Hz , the projected screen size is always adjusted to the format of 640X400 70Hz.
- To exit menu display, press the **MENU** button repeatedly.

Positioning

- * If the image size does not fit the screen in accordance with the input source, set the position of the image by selecting Horizontal / Vertical position.
- * **Keystone** function adjusts the upper and lower width of the projected image to prevent the image shape from being a trapezoid shape. Use this function when the screen or the projector is slanted and cannot make rectangular projection angle.

1 Press the **MENU** button and move the **POINTER** button up or down to select the POSITION menu.

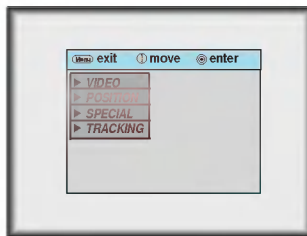

2 Press the **ENTER** button and move the **POINTER** button up or down to select (Horizontal), (Vertical) or (Keystone) item.

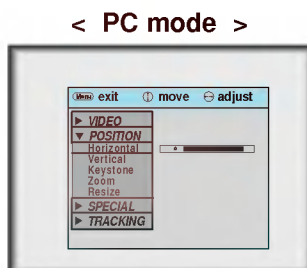

3 Press the **POINTER** button and move the button left or right or press the **VOLUME** (◀▶) button to adjust the screen condition as you want.

- (Horizontal), (Vertical), (Keystone) are adjusted from -50 to +50.
- To exit the menu display, press the **MENU** button repeatedly.

Zoom Function

- 1 Press the **ZOOM** button.

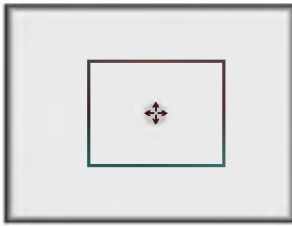

- 2 Move the **POINTER** button to move the rectangular zooming area and press the **ENTER** button to zoom the target area.

- 3 Press the **L MOUSE** or **R MOUSE** button to adjust the zoom level.

- * **L MOUSE** button makes the image look smaller.
- * **R MOUSE** button makes the image look larger.



- 4 Move to the position you want to see the enlarged display by moving the **POINTER** button left, right, up, or down.

- 5 Press the **ZOOM** button again to finish the zoom function.



- * You can use this function by using the **MENU** button.
- * In the zoom mode, you can adjust horizontal / vertical position with the **POINTER** button.



* You can use this function only under SVGA (800x600) mode in case of LP-XG2 model.

- 1 Press the **RESIZE** button.
Each press of the button changes the display as below.

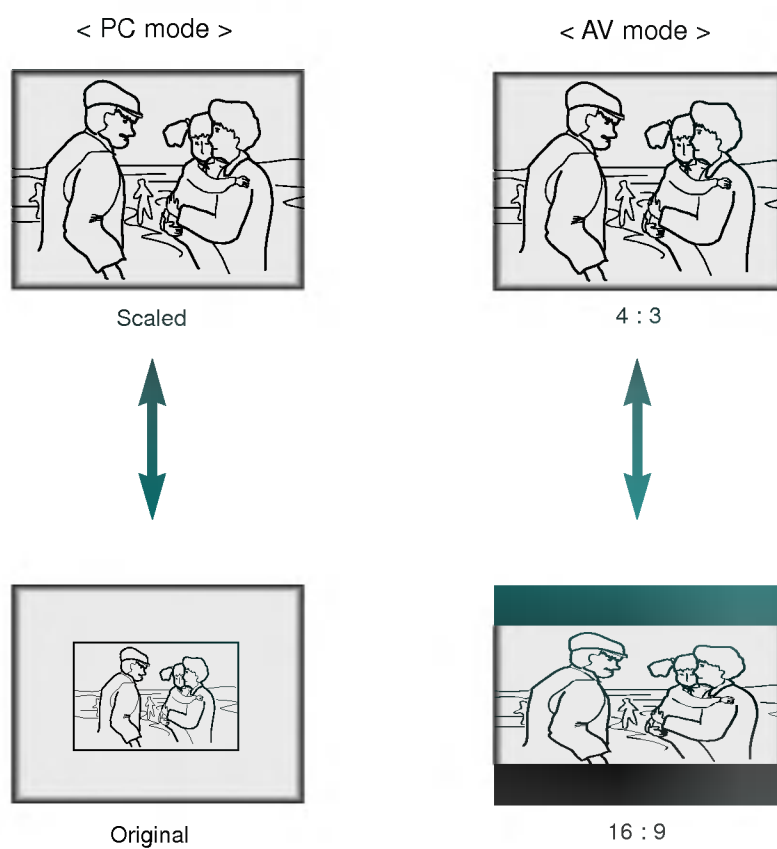

* You can also use this function by using the **MENU** button.

1 Press the **MENU** button and move the **POINTER** button up or down to select each VIDEO menu.



2 Press the **ENTER** button.



3 Move the **POINTER** button up or down to select a video item you want to adjust.

4 Move the **POINTER** button left or right or press the **VOLUME** (**◀▶**) button to adjust the selected video item as you want.

- To restore the original image condition after changing it, press **ENTER** button after selecting (**Reset**) item.
- To finish menu display, press the **MENU** button repeatedly.

- TRACKING menu is not displayed in <AV mode>.

Auto Tracking Function

* Auto Tracking Function

This function assures you of getting the best video quality by automatically adjusting the difference of horizontal width and tremor of the image. This difference is caused by disaccord of the internal signal of the projector and diverse graphic signals of PC.

* This function is operated only in PC mode.

- 1 Press the **AUTO TRACKING** button.



* Image positioning and tremor adjusting are automatically performed.

-
- 2 Adjust [**Clock**] or [**Phase**] in TRACKING menu after operation of [**Auto Tracking**] if you want to get better picture quality in accordance with diverse PC input modes. (Refer to page 40.)



* You can also use this function by using the **MENU** button.

* Perform this function while on stopped image because you may not get the best video quality on a moving image of PC graphic signal.

* TRACKING menu is not displayed in AV mode.

Clock / Phase Function

* Clock Function

This function adjusts the horizontal width of the projected image to get the image to fit on the screen size.

* Phase Function

This function is for the detailed adjustment of the clock function.

* These functions are operated only in PC mode.

- 1 Press the **MENU** button and move the **POINTER** button up or down to select the TRACKING menu.



- 2 Press the **ENTER** button and move the **POINTER** button up or down to select the (Clock) or (Phase) item.



- 3 Move the **POINTER** button left or right or press the **VOLUME** (◀▶) button to adjust the screen condition.

- To exit the menu display, press the **MENU** button repeatedly.

Supported Monitor Display

* The projector displays images at a resolution of 1024x768 pixels. To display higher resolution images(1152x864mode, 1280x1024mode), the projector compresses it to 1024x768. The following table lists the display formats supported by the projector.

Sources	Format	Vertical Freq. (Hz)	Horizontal Freq. (kHz)
VGAEGA	640X350	70.090Hz	31.468kHz
	640X350	85.080Hz	37.861kHz
PC98 / VGA text	640X400	85.080Hz	37.861kHz
	720X400	70.082Hz	31.469kHz
	720X400	85.039Hz	37.927kHz
VGA	640X480	59.940Hz	31.469kHz
	640X480	66.667Hz	35.00kHz
	640X480	72.800Hz	37.861kHz
	640X480	75.00Hz	37.500kHz
	640X480	85.008Hz	43.269kHz
	640X480	100.040Hz	53.011kHz
SVGA	640X480	120.00Hz	64.062kHz
	800X600	56.250Hz	35.156kHz
	800X600	60.317Hz	37.879kHz
	800X600	72.188Hz	48.077kHz
	800X600	75.00Hz	46.875kHz
	800X600	85.061Hz	53.674kHz
XGA	800X600	90.00Hz	56.00kHz
	800X600	100.00Hz	64.016kHz
	1024X768	43.479Hz	35.522kHz
	1024X768	60.004Hz	48.363kHz
	1024X768	70.069Hz	56.476kHz
	1024X768	75.029Hz	60.023kHz
SXGA	1024X768	84.997Hz	68.677kHz
	1152X864	60.053Hz	54.348kHz
	1152X864	70.016Hz	63.995kHz
	1152X864	75.00Hz	67.500kHz
	1152X864	85.057Hz	77.487kHz
	1280X960	60.00Hz	60.00kHz
	1280X960	75.00Hz	75.00kHz
	1280X960	85.002Hz	85.938kHz
	1280X1024	60.020Hz	63.981kHz
	1280X1024	75.025Hz	79.976kHz
UXGA	1280X1024	85.024Hz	91.146kHz
	1600X1200	60.00Hz	75.00kHz
MAC	16 _¥	832X624	74.550Hz
	19 _¥	1024X768	60.004Hz
		1024X768	75.029Hz
20 _¥	1152X870	75.062Hz	

* If the projector does not support the input signal, "CHECK INPUT SIGNAL" message appears on the screen.

* The projector supports DDC1/2B type as Plug & Play function.(Auto recognition of PC monitor)

- * The projector needs little maintenance. You should keep the lens clean because any dirt or stains may appear on the screen. You will also need to clean the air filter attached at the bottom of the projector periodically because a clogged air filter prevents proper ventilation that is necessary to cool the projector and prevents it from overheating. If any parts need to be replaced, contact your dealer. When cleaning any part of the projector, always turn the power off and unplug the projector first.

Cleaning the lens

Clean the lens whenever you notice dirt or dust on the surface of it. Wipe the lens surface gently with an air spray or a soft, dry lint-free cloth.

To remove dirt or stains on the lens, moisten a soft cloth with water and a neutral detergent and wipe the lens surface gently.

Cleaning the Projector Case

To clean the projector case, first unplug the power cable. To remove dirt or dust, wipe the casing with a soft, dry, lint-free cloth. To remove stubborn dirt or stains, moisten a soft cloth with water and a neutral detergent and then wipe the casing.

Do not use alcohol, benzene, thinners or other chemical detergents as these can cause the casing to be warped.

Cleaning the Air Filter

The air filter, which is located at the bottom of the projector, should be cleaned after every 100 hours' use. If it is not cleaned periodically, it can become clogged with dust and prevent the projector from being ventilated properly. This may cause overheating and damage of the projector.

To clean the air filter :

1. Switch the projector off and unplug the power cable from the wall socket.
2. Stand the side of the projector so that the handle can be at the top, and you can easily access the air filter.
3. Push the opening tip of the air filter cover and remove the cover.

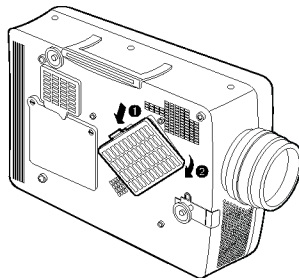

4. The air filter is in the cover of it. To clean the filter, you'd better use a small vacuum cleaner designed for computers or other office equipments. If not, you may use a dry, lint-free cloth.
If it is difficult to remove dirt or the filter is torn, contact your dealer or the service center to replace it .
5. Close the filter cover after cleaning.
6. Plug the power cable back into the wall socket.



- * When installing the projector on the ceiling use screws of which length is within 5 mm.
* Contact your dealer to get screws for fixing, the ceiling installer and the detailed explanation to install.

Reset Lamp Time

* You must reset lamp time on the menu after replacing the lamp.

- 1 Turn the power off but keep plugged in. Press the buttons on the control panel in the sequence as below.

▲ → ▼ → ◀ → ▶ → MENU → ENTER

Lamp time will be initialized.

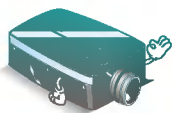

- * Power is not turned on after 1500 hours' use. In this case, you can turn the power on only by initiating the lamp time with the above operation.
- * If you don't replace the lamp after resetting the lamp time, the lamp may be damaged.

LP-XG2
 22.9mm(0.9 inches)
 LP-XG2 : 1024(Horizontal) x 768(Vertical)pixel
 1.01~7.6m(40~300 inches)
 1.64~16.35m(5.03~54.08 feet)
 12m
 1W
 4:3(horizontal:vertical)
 1:1.3
 AC 110 - 240V~50/60Hz
 98.5mm(including front foot)
 238mm
 329.5mm(including lens)
 3.4kg

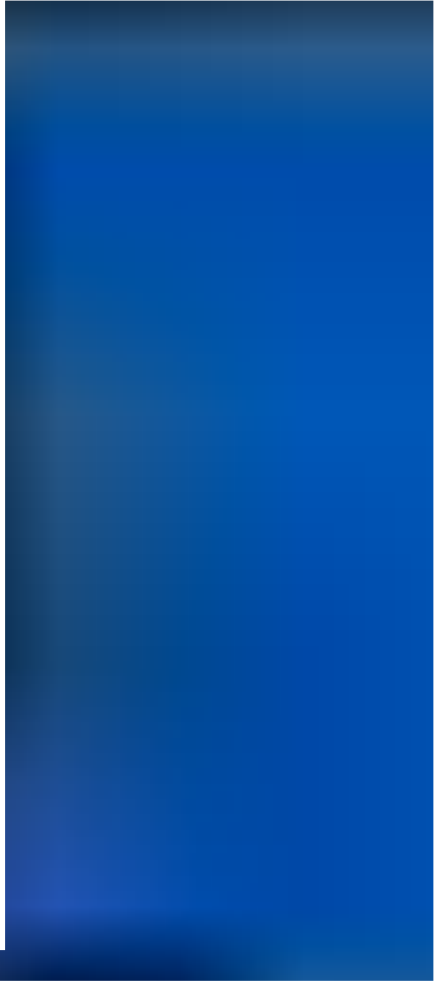

Operating Condition

In operation : 32~104°F(0°C~35°C)
 In storage and transit : -4~140°F(-20°C~60°C)

In operation : 20 ~ 80% relative humidity by dry hygrometer
 Not in operation : 10 ~ 90% relative humidity by dry hygrometer

Projection Lamp

TP-L2

150W

