

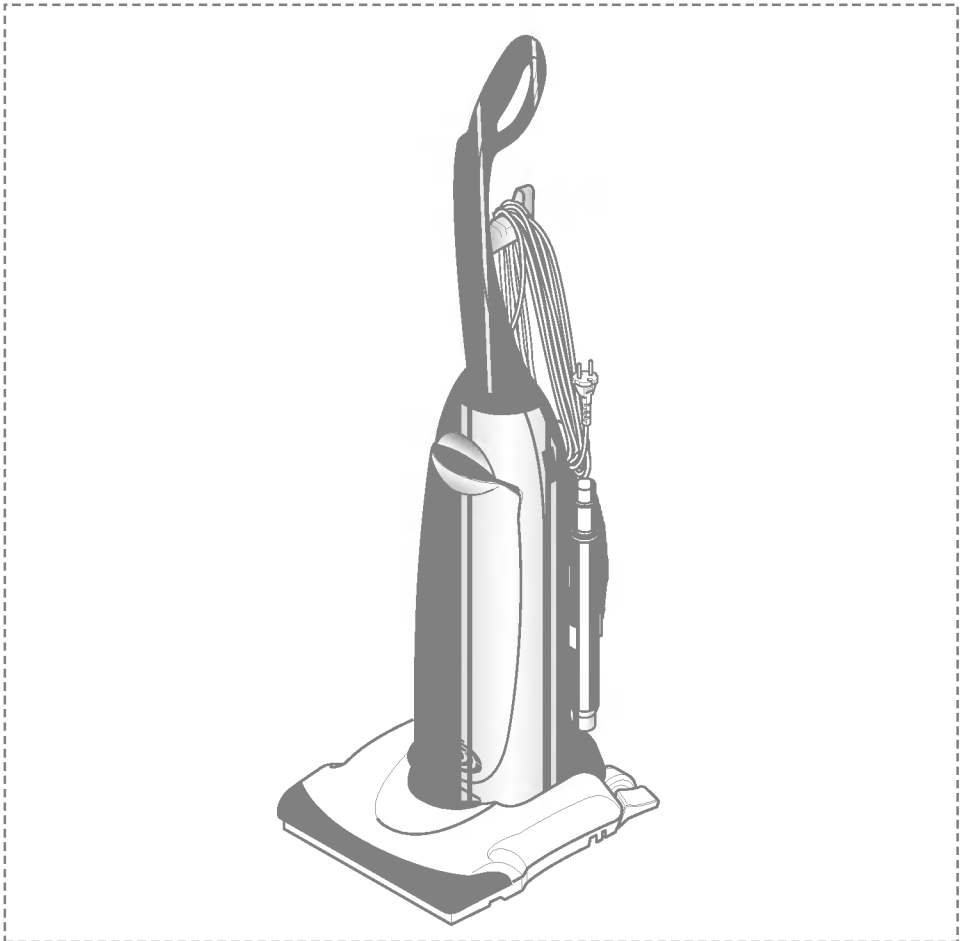

Website <http://www.LGService.com>
E-mail <http://www.LGService.com/techsup.html>

Upright Vacuum Cleaner Owner's Manual

**MODEL: V-U5540NB
V-U5545NB**



**PLEASE READ THIS MANUAL
THOROUGHLY AND CAREFULLY
BEFORE OPERATING THE CLEANER**

P/No.:3828FI3750X

TABLE OF CONTENTS

IMPORTANT SAFEGUARDS	3
ASSEMBLING CLEANER	4
- STEP 1. UNPACK CARTON	4
- STEP 2. ASSEMBLE HANDLE	4
- STEP 3. ASSEMBLE CORD	5
- STEP 4. ATTACH TOOLS	5
CLEANER DESCRIPTION	6
SPECIAL FEATURES	7
- Automatic Adjusting Nozzle	7
- Detachable Attachment Kit	7
- Edge Cleaning Feature	7
OPERATION	8
- Important Safety Tips	8
- On/Off Switch	8
- Handle Positions	8
- Transporting Cleaner	9
- Using the Cord Hanger	9
- Using Cord Hook	9
- Using Attachments	10
REMOVING CLOGS	11
REPLACEMENT INSTRUCTIONS	12
- Removing/Installing the Bottom Plate	12
- Replacing Belt and/or Agitator	13
- Replacing Exhaust Filter	13
- Replacing Dust Bag	14
- Replacing Clean Filter	14
MAINTENANCE	15
- Cleaning Agitator	15
SPECIFICATIONS	15
PARTS	15
BEFORE REQUESTING SERVICE	16

IMPORTANT SAFEGUARDS



WARNING

Your safety is important to us. To reduce the risk of fire, electrical shock, injury to persons, or damage when using your vacuum cleaner, follow basic safety precautions, including the following:

1. Disconnect power supply before servicing and/or cleaning the unit.
2. Do not leave appliance plugged in. Unplug from outlet when not in use or before servicing.
3. Do not use outdoors or on wet surfaces. Do not pick up water or wet materials.
4. Do not handle plug or appliance with wet hands.
5. Do not allow it to be used as a toy. Close attention is necessary when used by or near children.
6. Use only as described in this manual. Use only attachments recommended by manufacturer.
7. Do not use with damaged cord or plug. If the supply cord is damaged, it must be replaced by the manufacturer or an Authorized Service Center or a similarly qualified person in order to avoid a hazard.
8. Do not pull or carry by the power cord as a handle, close door on cord, or pull the cord around sharp edges or corners. Do not run appliance over the cord. Keep the cord away from heated surfaces.
9. Do not unplug by pulling the cord. To unplug, grasp the plug, not the cord.
10. Do not put any object into openings. Do not use with any opening blocked. Keep free from dust, lint, hair and anything that may reduce air flow.
11. Keep hair, loose clothing, fingers, and all parts of body away from the openings and moving parts.
Do not use vacuum cleaner to pick up sharp, hard objects, small toys, pins, etc.
12. Do not pick up anything that is burning or smoking, such as cigarettes, matches, or hot ashes.
13. Do not use to pick up flammable or combustible liquid or vapors such as gasoline or use in areas where they may exist.
14. Do not use vacuum cleaner without dust bag and/or filters in place.
15. Always turn off all controls before unplugging.
16. Do not keep vacuum cleaner on chairs, tables, etc. Extra care must be taken when cleaning stairs.
17. Always unplug the unit or turn off the switch when the unit automatically stops unintentionally. If you don't, the cleaner could re-start unintentionally.

Thermal protector: This vacuum cleaner has a special thermostat that protects the cleaner in case of motor overheating. If the cleaner suddenly shuts off, turn off the switch and unplug the cleaner. Check the cleaner for a possible source of overheating such as a full bag, a blocked hose or clogged filter. If these conditions are found, fix them and wait at least 30 minutes before attempting to use the cleaner. After the 30 minutes period, plug the cleaner back in and turn on the switch. If the cleaner still does not run, contact a qualified electrician.

SAVE THESE INSTRUCTIONS
THIS PRODUCT IS FOR HOUSEHOLD USE ONLY

ASSEMBLING CLEANER



WARNING

Electrical Shock Hazard

Do not plug into the electrical supply until the assembly is complete.
Failure to do so could result in electrical shock or injury.

STEP 1: UNPACK CARTON

Remove all parts from carton and identify each item as shown in figure.

Make sure all parts are located before disposing of carton box.

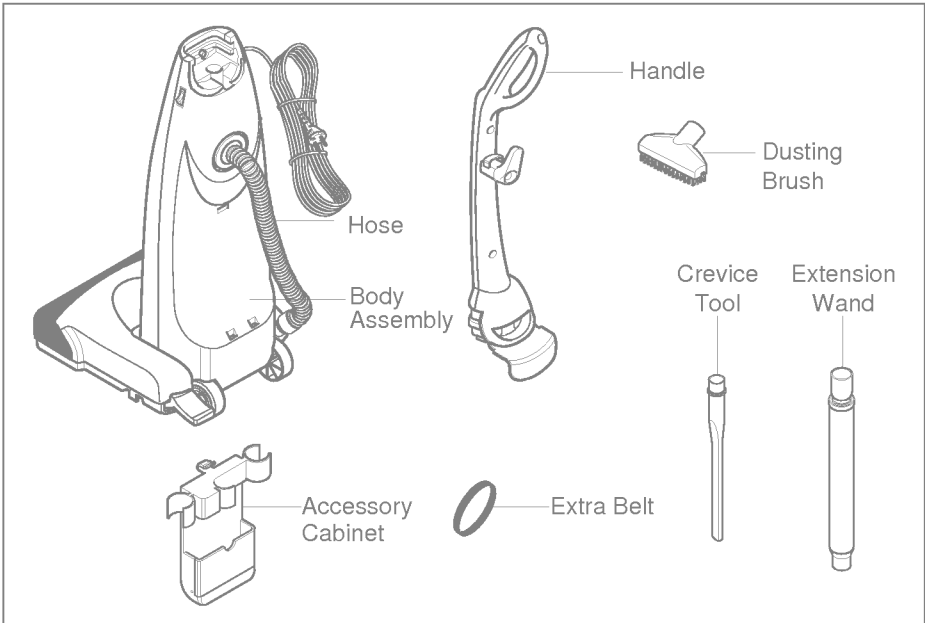

STEP 2: ASSEMBLE HANDLE

Position the handle as shown.

Slide the handle into the opening at the top of the vacuum. (Fig.A)

Insert the bolt into the handle bolt screw hole.

Using a screwdriver, tighten the bolt. (Fig. B)

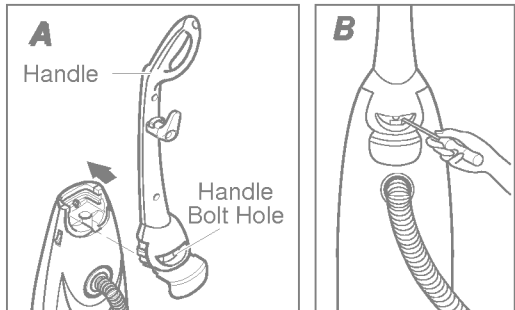

ASSEMBLING CLEANER



WARNING

Electrical Shock Hazard

Do not plug into the electrical supply until the assembly is complete.
Failure to do so could result in electrical shock or injury.

STEP 3: ASSEMBLE CORD

Make sure the quick release cord hanger is in the upright position.

Lock the cord into place by forcing it into the locking notch on the body of the quick release cord hanger. (Fig. A)

Wrap the power cord around the quick release cord hanger and lower cord Retainer, then lock the power cord plug onto the power cord. (Fig. B)

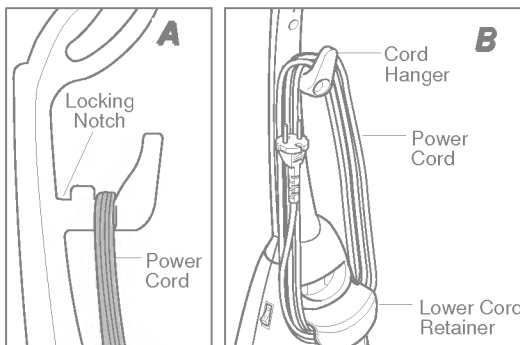

STEP 4: ATTACH TOOLS

Insert the tabs of accessory cabinet into the grooves at the rear of the body, and snap the hook into the upper groove. (Fig. A)

Attach the extension wand on the left side of accessory cabinet.

Slide the crevice tool into the extension wand.

Place the dusting brush on the top of the accessory cabinet. (Fig. B)

Store small spare parts such as the extra belt, in the cabinet. (Fig. C)

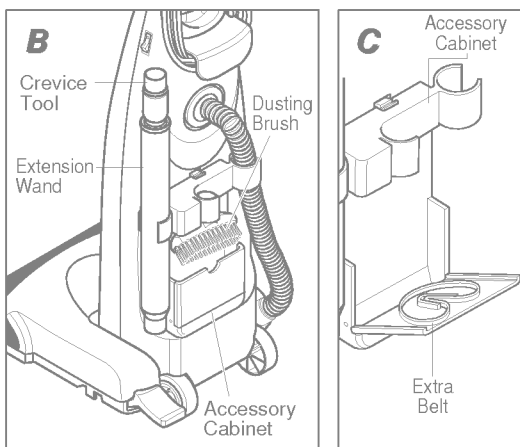
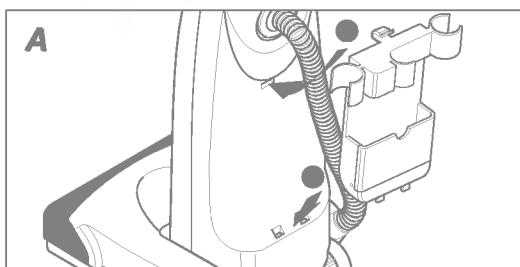

CLEANER DESCRIPTION

After assembly, the cleaner will look like the picture below.

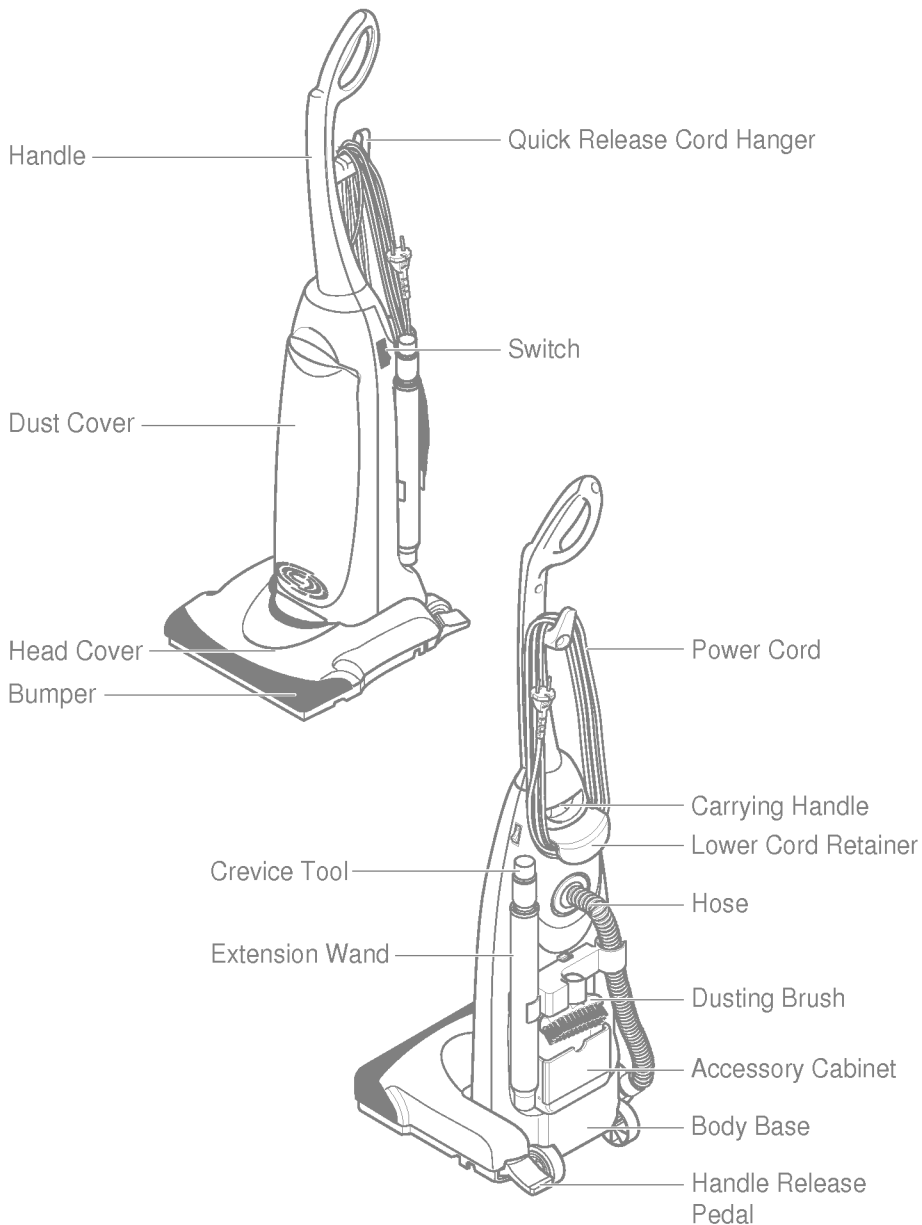

SPECIAL FEATURES

Automatic Adjusting Nozzle

Your upright vacuum cleaner is designed with an automatic adjusting nozzle. No manual adjustments are required. The nozzle height is instantly and automatically adjusted to any carpet pile height.

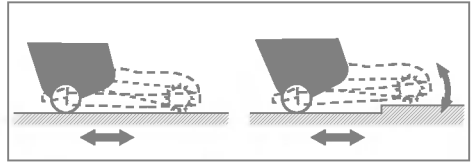

Detachable Attachment Kit

Attachments are carried on board for easy use when cleaning furniture, cushions, stairs, etc. (Fig A)

If attachments are not necessary for a while, you can remove the whole attachment kit from the body of the vacuum. (Fig. B)

Without attachment kit on the body, your vacuum will be lighter.

This feature can make your vacuum move and maneuver more easily.

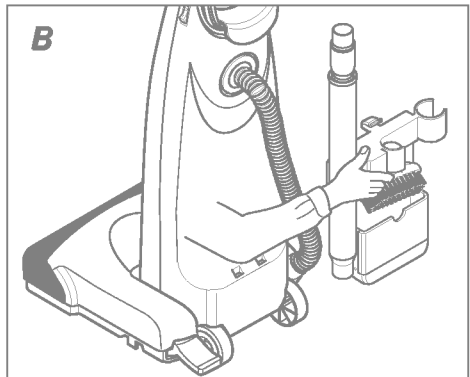
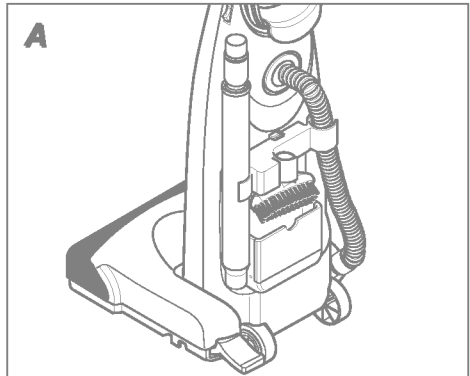

Edge Cleaning Feature

Edge cleaning provides for improved cleaning of carpets near walls and furniture.

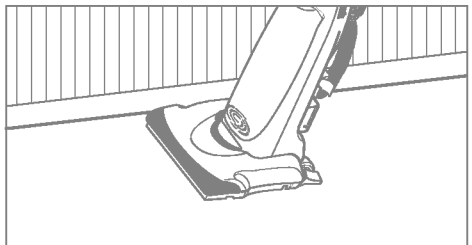

OPERATION



WARNING

Personal Injury and Product Damage Hazard

- DO NOT plug in if switch is in the ON position. Personal injury or damage could occur.
- DO NOT use outlets above counters. Damage to items in the surrounding area could occur.

Important Safety Tips

Before you plug in your vacuum cleaner, make sure that the voltage indicated on the rating label of the vacuum cleaner is the same as your local supply.

On/Off Switch

Plug the power cord to operate cleaner.

I is the ON position.

0 is the OFF position.

When cleaner stops automatically, always turn off the switch and unplug the unit before checking. If could start automatically and cause an injury.

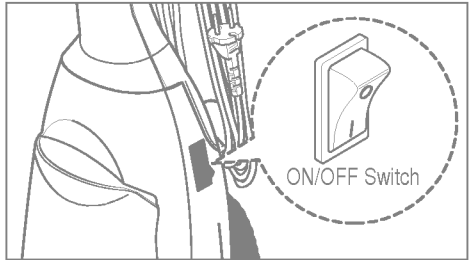
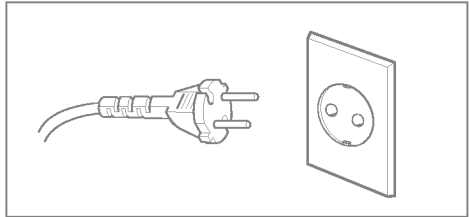

Handle Positions

The handle may be adjusted to any position required.

Step on the handle release pedal. The handle is released to move up and down freely. Adjust the body to any position you required.

When cleaning under furniture, press the handle release pedal a second time.

To store vacuum or use attachments, set the handle to the upright position.

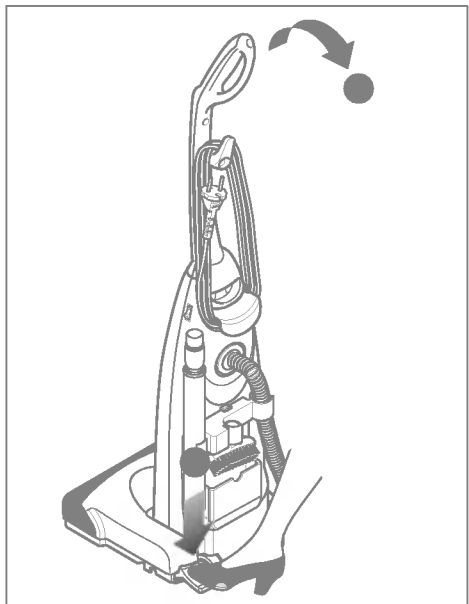

OPERATION



WARNING

Personal Injury and Product Damage Hazard

- DO NOT plug in if switch is in the ON position. Personal injury or damage could occur.
- DO NOT use outlets above counters. Damage to items in surrounding area could occur.

Transporting Cleaner

To move your cleaner from room to room, put the handle in upright position, tilt the cleaner back on its rear wheels and push it forward.

The cleaner can also be moved by lifting it, as shown.

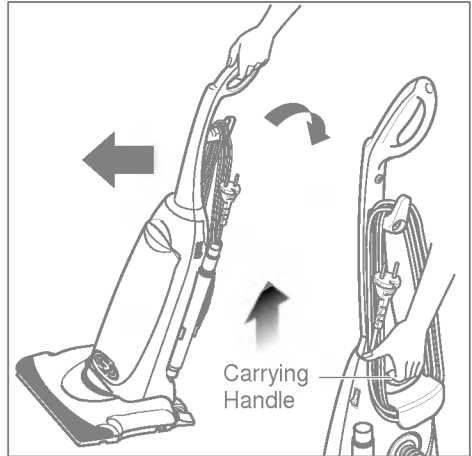

Using the Cord Hanger

To release the power cord, rotate the quick release cord hanger downward and the entire power cord will drop off the hanger for immediate use.

Do not unplug the cleaner by pulling on the cord. Grasp the plug head and pull to unplug the vacuum cleaner.

Return the quick release cord hanger to the upright position before attempting to rewind the cord.

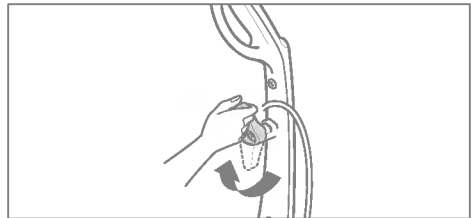

Using Cord Hook

There is a recessed area on the body of the quick release cord hanger, designed to secure the power cord during vacuuming.

Insert the power cord into this groove to help keep the power cord from hanging and being damaged by agitator or other moving parts.

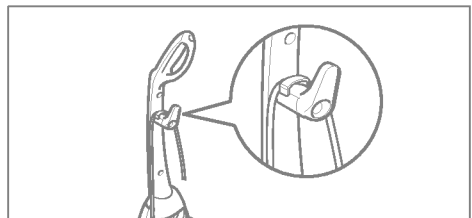

OPERATION



WARNING

Personal Injury and Product Damage Hazard

- DO NOT plug in if switch is in the ON position. Personal injury or damage could occur.
- DO NOT use outlets above counters. Damage to items in surrounding area could occur.

Using Attachments

Remove the lower end of stretch hose from the vacuum by pulling out the hose collar. (Fig. A)

Remove the telescopic wand from its storage position. (Fig. B)

Remove the crevice tool from the extension wand. (Fig. C)

Turn the lower extension wand to the UNLOCK position. (Fig. D)

Extend the wand to its full length.
Turn the lower wand to LOCK position.
(Fig. D)

Attach the extension wand onto the hose collar. (Fig. E)

Attach crevice tool or dusting brush onto the end of extension wand.
Crevice tool and dusting brush will also fit on the hose collar.

The dusting brush has two options.
When the front brush is removed, the remaining part can be used as an upholstery nozzle. (Fig. F)

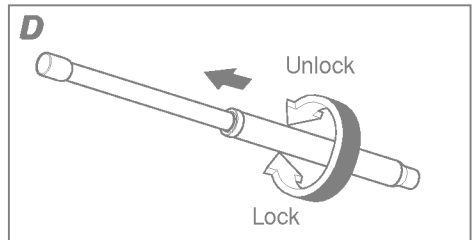
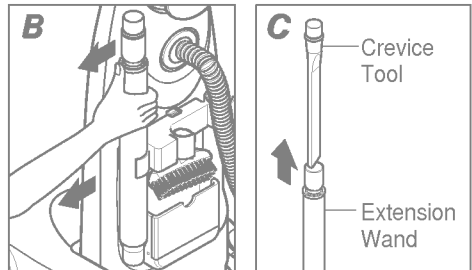
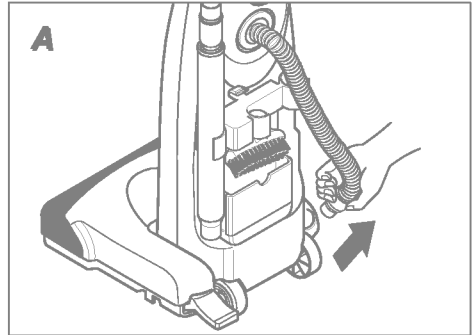

CAUTION

When using attachments, be careful not to overextend the hose. This could cause the cleaner to tip over.

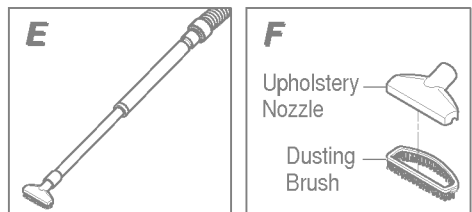

REMOVING CLOGS



WARNING

Electrical Shock or Personal Injury Hazard

Disconnect electrical supply before servicing or cleaning the unit. Failure to do so could result in electrical shock or personal injury from cleaner suddenly starting.

If the cleaner does not seem to have adequate suction, first check to see if the bag is full.

If the bag is not full, check the hose and extension wand.

Visually inspect the hose and the opening of the head cover into which the hose is inserted. (Fig. A)

If the clog still exists, make sure to turn the vacuum cleaner off and unplug the power cord. Turn the vacuum cleaner over to expose the underside. Check the agitator area and suction inlet. (Fig. B)

Return the vacuum to the upright position before plugging into the electrical outlet.

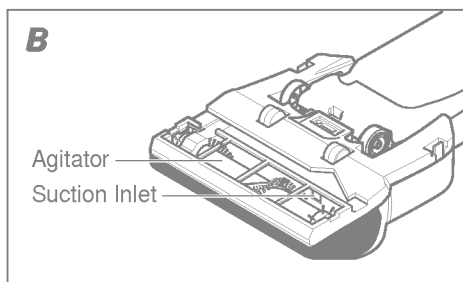
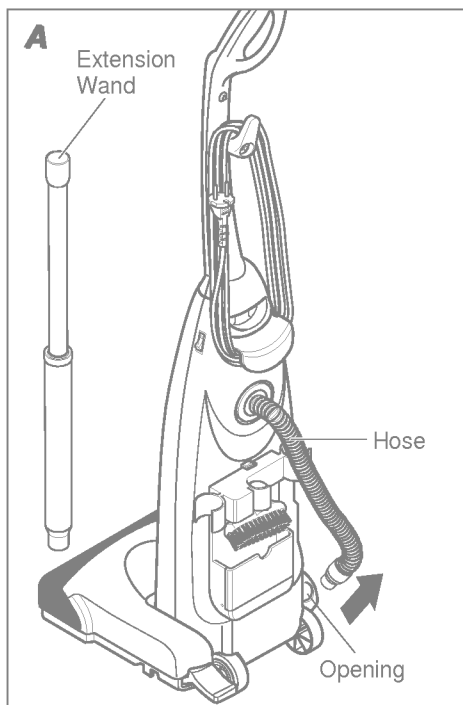

REPLACEMENT INSTRUCTIONS



WARNING

Electrical Shock or Personal Injury Hazard

Disconnect electrical supply before servicing or cleaning the unit. Failure to do so could result in electrical shock or personal injury from cleaner suddenly starting.

Removing/Installing the Bottom Plate

Before replacing any parts, disconnect the vacuum from the electrical outlet.

To remove the bottom plate, unscrew the bottom plate first. (Fig. A)

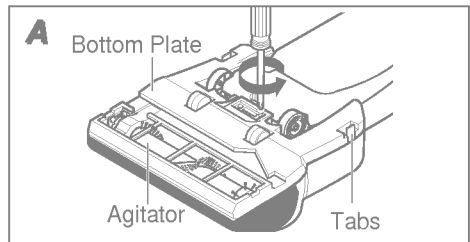

Pushing the locking tabs toward the center of the vacuum, pull the bottom plate away from the nozzle housing. (Fig. B)

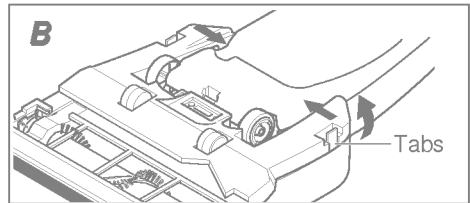

To install the bottom plate, hook the front end of bottom plate into the slots on the front of nozzle. (Fig. C)

Press the bottom plate until the locking tabs snap into place then tighten the screw.

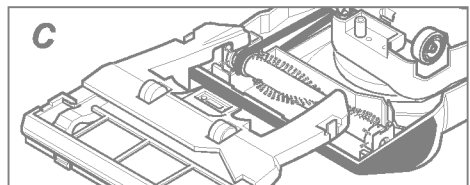

REPLACEMENT INSTRUCTIONS



WARNING

Electrical Shock or Personal Injury Hazard
Disconnect electrical supply before servicing or cleaning the unit. Failure to do so could result in electrical shock or personal injury from cleaner suddenly starting.

Replacing Belt and/or Agitator

Check the belt and agitator frequently. If they are broken or worn out, replace them.

Turn the unit over and remove the bottom plate as described in Removing/Installing the Bottom Plate section.

To remove the belt or agitator, grasp the both ends of agitator and lift it slowly. Remove the belt from agitator pulley and motor shaft. If the belt was broken, be sure all pieces are removed.

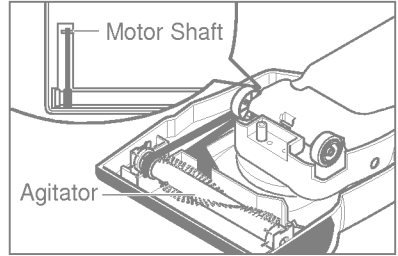

WARNING

Personal Injury Hazard
Be careful when removing the agitator as the belt tension is high.
Failure to do so could result in personal injury from the agitator releasing quickly and snapping away.
The motor shaft may be very hot!

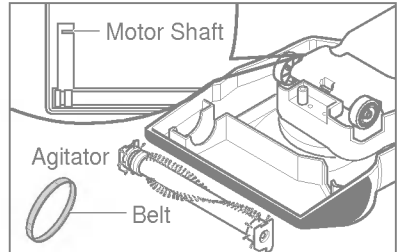

Loop the new belt around the motor shaft and agitator pulley.

Reinsert the agitator making sure that both ends of the agitator fit in the groove of the nozzle head. After installing the agitator, turn it by hand making sure that the belt is not twisted or pinched and all parts turn freely.

Replace the bottom plate as described in the Removing/Installing the Bottom Plate section.

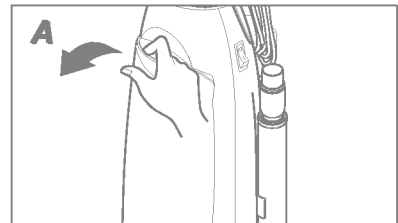

Replacing Exhaust Filter

This exhaust filter must be replaced when dirty.

Pull outward on the dust cover grip to remove dust cover. (Fig. A)

Replace exhaust filter and close the dust cover. (Fig. B)

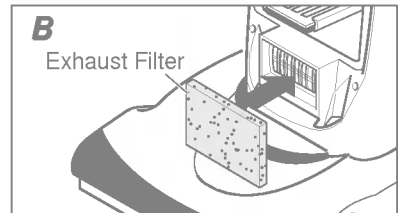

REPLACEMENT INSTRUCTIONS



WARNING

Electrical Shock or Personal Injury Hazard

Disconnect electrical supply before servicing or cleaning the unit. Failure to do so could result in electrical shock or personal injury if the cleaner starts suddenly.

Replacing Dust Bag

Check the bag from time to time. When excessive dirt accumulates, your cleaner may not operate effectively.

If the cleaner does not seem to have adequate suction, check the bag.

DISCONNECT THE CLEANER FROM THE ELECTRICAL OUTLET.

Pull the dust cover grip forward and remove the dust cover from the cleaner. (Fig. A)

Grasp the dust bag collar and pull it out.

Attach a new dust bag onto the bag holder holding the dust bag collar and pushing back as shown in the figure. (Fig B)

Insert the tabs on the bottom of dust cover into the grooves on the dust compartment. (Fig. C)

Rotate the dust cover up into the closed position and press it until the hook snaps into place.

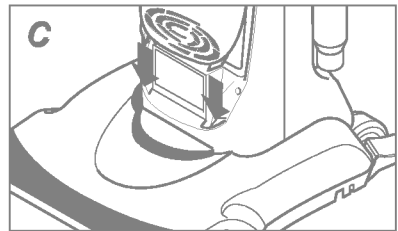
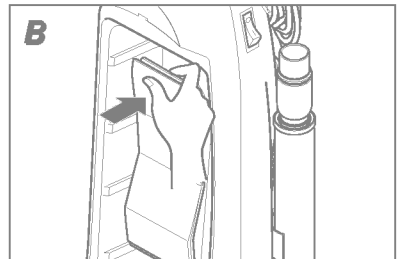
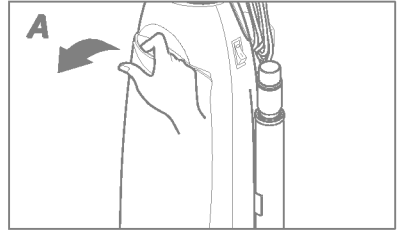

Replacing Clean Filter

The clean filter is located inside the dust compartment. When installing or changing the dust bag, always check this filter. When the filter becomes dirty, clean it or install a new one.

To remove this filter, open the dust cover and pull the filter out from the bottom of dust compartment.

To clean the old filter, rinse it in water and dry it.

Slide this filter back into place. It should be fully inserted into the projections of the bottom of dust compartment. Be sure the filter is dry.

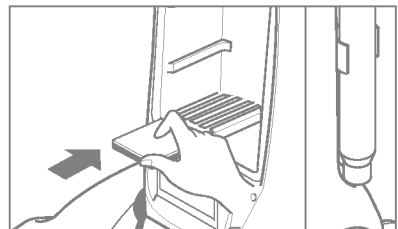

MAINTENANCE



WARNING

Electrical Shock or Personal Injury Hazard

Disconnect electrical supply before servicing or cleaning the unit. Failure to do so could result in electrical shock or personal injury from cleaner suddenly starting.

Cleaning Agitator

In order to keep the cleaning efficiency high, clean the agitator frequently.

Make sure to unplug the unit.

Turn the unit over on the floor. If necessary, remove bottom plate as described in Removing/Installing the bottom plate section.

Remove the entangled materials, such as carpet pile and lint, strings, etc. Unwind them or cut them off with scissors, as shown.

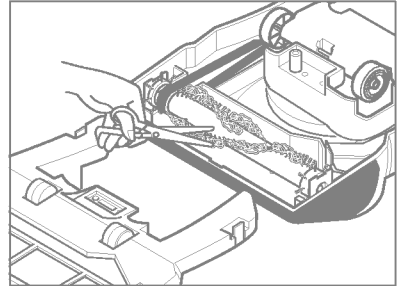

SPECIFICATIONS

Model	V-U5540NB	V-U5545NB
Power supply	230V	
Power	IEC-1200W, MAX-1400W	
Frequency	50Hz	
Dimension/upright position (WxDxH)	approx. 335 x 1138 x 322 mm(13 ³ / ₁₆ x 44 ¹³ / ₁₆ x 12 ¹¹ / ₁₆ ")	
Cord length	9.1 m(30')	7.6 m(25')
Weight (approx.)	6.8 kg(15 lb)	6.4 kg(14 lb)

PARTS

Model	V-U5540NB	V-U5545NB
Dust Bag	Type UR-B(Part No.:5231FI2453B)	
Belt	4400FI3348A	
Exhaust Filter(HEPA)	5231FI3756A	
Exhaust Filter(Micron)	5231FI3757A	

BEFORE REQUESTING SERVICE

Review this chart to find out a possible solution if a minor problem occurs. Any service needed, other than that described here, should be performed by an authorized service center.



WARNING

Electrical Shock Hazard

Disconnect electrical supply before servicing or cleaning the unit. Failure to do so could result in electrical shock or personal injury.

Problem	Possible cause	Possible solution
Cleaner won't run.	<ol style="list-style-type: none">1. Not firmly plugged in2. No voltage in wall outlet3. On/Off switch not turned on4. Blown fuse5. Thermal protector operated	<ol style="list-style-type: none">1. Plug in firmly.2. Check fuse or breaker.3. Push On/Off switch.4. Ask authorized service center.5. Unplug, turn off and allow to cool. See page 3.
Cleaner won't pick up.	<ol style="list-style-type: none">1. Broken or worn belt2. Worn agitator brush3. Full or clogged dust bag4. Hole in hose5. Dust cover improperly installed6. Belt not installed on motor shaft	<ol style="list-style-type: none">1. Replace belt.2. Replace agitator.3. Change bag.4. Replace hose.5. Properly install6. Install belt on motor shaft.
Dust escapes the paper bag.	<ol style="list-style-type: none">1. Bag improperly installed2. Torn bag	<ol style="list-style-type: none">1. Install bag properly.2. Replace bag.

