

Introduction

Thank you for purchasing a high resolution monitor. It will give you high resolution performance and convenient reliable operation in a variety of video operating modes.

ENGLISH

Features

- The monitor is a 17 inches (15.9 inches viewable) intelligent, microprocessor based monitor compatible with most analog RGB (Red, Green, Blue) display standards, including IBM PC®, PS/2®, Apple®, Macintosh®, Centris®, Quadra®, and Macintosh II family.
- The monitor provides crisp text and vivid color graphics with VGA, SVGA, XGA, and VESA Ergonomic modes (non-interlaced), and most Macintosh compatible color video cards when used with the appropriate adaptor. The monitor's wide compatibility makes it possible to upgrade video cards or software without purchasing a new monitor.
- Digitally controlled auto-scanning is done with the micro-processor for horizontal scan frequencies between 30 and 70kHz, and vertical scan frequencies between 50-160Hz.
- This monitor is capable of producing a maximum horizontal resolution of 1280 dots and a maximum vertical resolution of 1024 lines.
- The microprocessor-based digital controls allow you to adjust conveniently a variety of image controls by using the OSD (On Screen Display).
- Plug and play capability if supported by your system.
- This monitor has DDC 2B function.*
- Compliant with the following regulated specifications :*
 - EPA ENERGY STAR
 - Swedish MPR II
 - Swedish TCO'99 (Applies to 77ME only)

* For detailed information, please refer to the **Reference Guide** provided.

On the back of the monitor are two plug-in connections; one for the AC power cord, and the other for the signal cable from the video card.

- Power off both the monitor and PC.
- Connect the 15 pin VGA connector of the supplied signal cable to the output VGA video connector on the PC. The connectors will mate only one way. If you cannot attach the cable easily, turn the connector upside down and try again. When mated, tighten the thumbscrews to secure the connection.
- Locate the appropriate MAC to VGA adapter block at your local computer store. This adapter changes the high density 3 row 15 pin VGA connector to the correct 15 pin 2 row connection to mate with your MAC. Attach the other end of the signal cable to the side of the adapter block with 3 rows.

Connect the attached adapter block/signal cable to the video output on your MAC.

- One end of the AC power cord is connected into the AC power connector on the back of the monitor. The other end is plugged into a properly grounded three-prong AC outlet.
- Power ON the PC, then the monitor.
- If you see the SELF DIAGNOSTICS message, check the signal cable and connectors.
- After using the system, power OFF the monitor, then the PC.

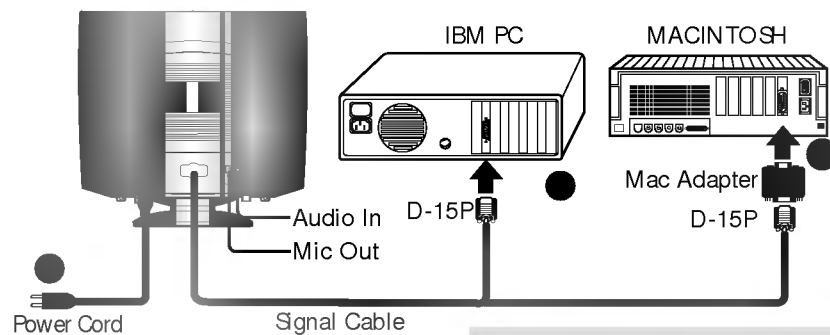

* NOTE : For Apple Macintosh use, a separate plug adapter is needed to change the 15 pin high density (3 row) D-sub VGA connector on the supplied cable to a 15 pin 2 row connector.



Front View

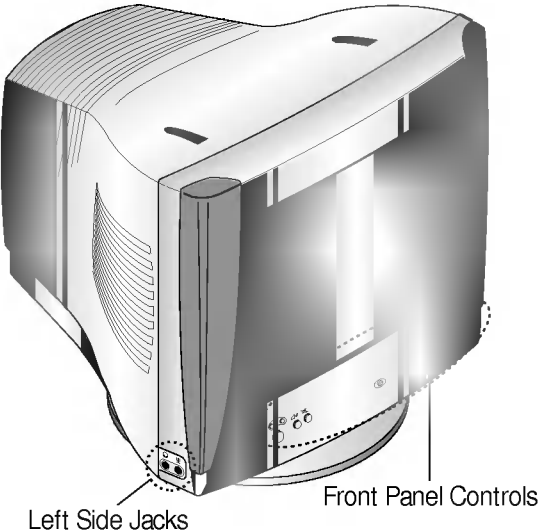



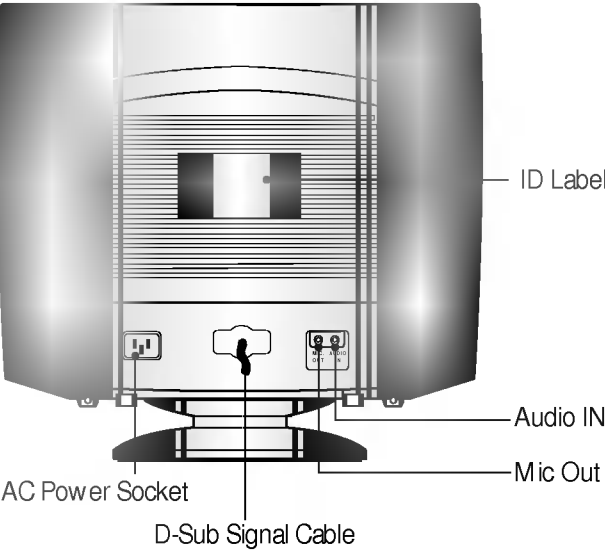



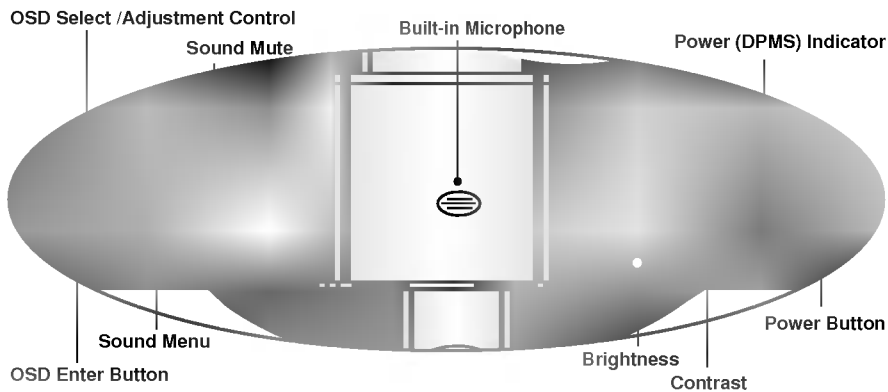

Rear View





Front Panel Controls



Control	Function
 OSD Select/ Adjustment Control	Use these buttons to choose or adjust items in the on screen display.
 OSD Button	Use this button to enter or exit the on screen display.
 Sound Menu	To adjust sound menu.
 Sound Mute	Used to select mute on (means sound off) and mute off (means sound on).
 Built-in Microphone	Built-in Microphone.
 Brightness Adjustment Control	Used to adjust the brightness of the screen.
 Contrast Adjustment Control	Adjust the display to the contrast desired.
 Power (DPMS) Indicator	This Indicator lights up green when the monitor operates normally. If the monitor is in DPM (Energy Saving) mode (stand-by/suspend/power off), this indicator color changes to amber.
 Power Button	Use this button to turn the monitor on or off.



Left Side Jacks

	Headphone Jack 	Headphone Jack that automatically mutes the speaker volume when headphone is attached.
	Microphone Jack 	An external microphone can be used instead of the built-in microphone.

Rear Panel Jacks

	Mic. Out	Connects microphone sound to PC via cable.
	Audio In	Connects speaker sound to PC via cable attachment.

Microphone Operation

On the left side there is a MIC (Microphone) jack. By plugging a microphone in here, it may reduce the long length of cable needed to reach the PC's sound card. In order to use this MIC jack, you need to use a cable (supplied) to plug into the rear of the monitor (MIC OUT) and into the MIC input jack of your sound card (if available).

Audio Features

A major feature of this monitor is its built-in audio system. This conveniently integrates a stereo audio amplifier and speakers without taking up any more space. Because the monitor is designed like this, you can easily upgrade to audio capable multimedia applications by attaching your PC with sound card to the back of this monitor. It will result in significantly less cabling and space requirements.







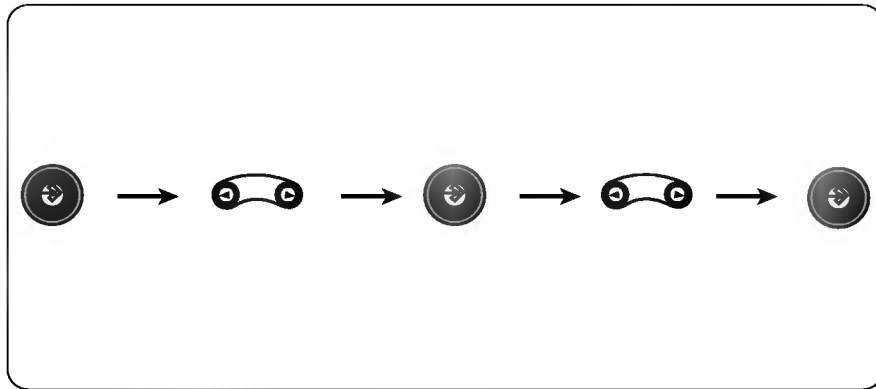

Making adjustments to the image size, position and operating parameters of the monitor are quick and easy with the On Screen Display Control system. A quick example is given below to familiarize you with the use of the controls. Following section is an outline of the available adjustments and selections you can make using the OSD.

NOTE

- Allow the monitor to stabilize for at least 30 minutes before making image adjustment.

To make adjustments in the On Screen Display, follow these steps:





- 1** Press the  Button, then the main menu of the OSD appears.
- 2** To access a control, use the  Buttons. When the icon you want becomes highlighted, press the  Button.
- 3** Use the  Buttons to adjust the item to the desired level.
- 4** Accept the changes by pressing the  Button.



TRAPEZOID





To correct geometric distortion.

-  Makes the screen image narrower at the top.
-  Moves the screen image wider at the top.

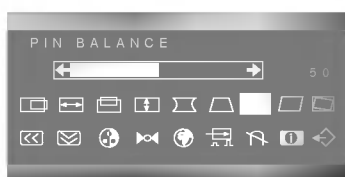
PIN BALANCE





To correct the balance of both sides bowing.

-  Curvature of the sides to the right.
-  Curvature of the sides to the left.

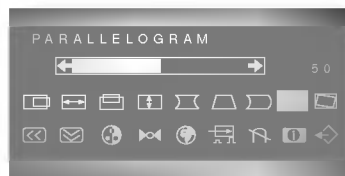
PARALLELOGRAM





This control adjusts for a skewing of the screen image.

-  Tilts the screen image leftward.
-  Tilts the screen image rightward.

TILT



To correct image rotation.

-  Tilts the screen image left.
-  Tilts the screen image right.

H MOIRE



Reduce horizontal moire when interference patterns of dark steady wavy lines appear on your screen. The moire adjustments may affect the focus of the screen.



V MOIRE



Reduce vertical moire when interference patterns of dark steady wavy lines appear on your screen. The moire adjustments may affect the focus of the screen.

COLOR







- **9300** : To appear the display's color temperature. Slightly bluish white.
- **6500** : To appear the display's color temperature. Slightly reddish white.
-  : Temperature range is from 5000K to 10000K. So, user easily color set without adjustment Red, Green and Blue (R/G/B).
-  : To set your own color levels. Allow for specific adjustments to Red, Green and Blue (R/G/B).
-  : To exit the COLOR OSD.

RECALL



You can use this function when you want to go back to the screen display of the time you purchased the product after adjusting to modify it in the Preset Mode.

When you are in the User mode, you can recall only , , ,  items. After using Recall, adjust the screen display again if necessary. If you want more information on the Preset Mode, refer to A12 page.

LANGUAGE



To choose the language in which the control names are displayed. OSD Menus are available in 7 languages : **English, Deutsch, Français, Español, Italiano, Português and Korean.**

VIDEO LEVEL



This item is used to select the monitor's input signal level. The normal level used for most PC's is 0.7V. When the screen suddenly gets brightened or blurry, please select 1.0V and try again.

DEGAUSS

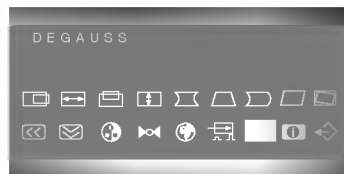

To manually demagnetize the screen which may show some image or color incorrectly.

INFORMATION



To inform users of preset and user mode data.

-  : USER MODE
-  : PRESET MODE

EXIT

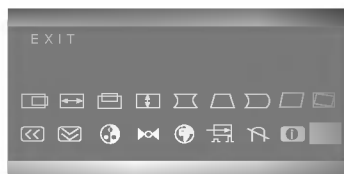





To disappear of the OSD on the screen.

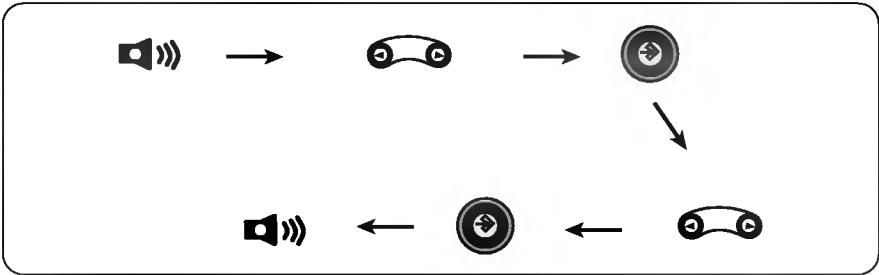

You were introduced to the procedure of selection and adjusting an item using the OSD system. Listed below are the icons, icon names, and icon descriptions of the items that are shown on the main Menu.

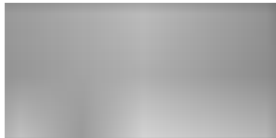
To make adjustments in the On Screen Display, follow these steps:



	VOLUME	Raises or lowers audio level.
	TREBLE	Raises or lowers treble level.
	BASS	Raises or lowers Bass level.
	BALANCE	Changes balance of left/right speaker level.
	MICROPHONE	Enables or disables microphone usage.



Video Memory Modes

The monitor has 36 memory locations for display modes, 11 of which are factory preset to popular video modes.

Preset Modes (Resolution)

	Display Modes (Resolution)		Horizontal Freq. (kHz)	Vertical Freq. (Hz)
1	VGA	640 x 480	37.50	75
2	VESA	800 x 600	46.88	75
3	VESA	800 x 600	53.68	85
4	VESA	1024 x 768	68.677	85
5	MAC	640 X 400	31.47	70
6	VESA	640 X 480	31.47	60
7	VESA	800 X 600	37.88	60
8	VESA	640 X 480	43.27	85
9	VESA	832 X 624	49.75	75
10	VESA	1024 X 768	60.02	75
11	VESA	1280 X 1024	63.98	60

User Modes

- Modes 12-36 are empty and can accept new video data. If the monitor detects a new video mode that has not been present before or is not one of the preset modes, it stores the new mode automatically in one of the empty modes starting with mode 12.

If you use up the 24 blank modes and still have more new video modes, the monitor replaces the information in the user modes starting with mode 12.

Recalling Display Modes

- When your monitor detects a mode it has seen before, it automatically recalls the image settings you may have made the last time you used that mode.

You may, however, manually force a recall of each of the 11 preset modes by pressing the Recall button. All preset modes are automatically recalled as the monitor senses the incoming signal.

The ability to recall the preset modes is dependent on the signal coming from your PC's video card or system. If this signal does not match any of the factory modes, the monitor automatically sets itself to display the image.

Check the following before calling for service.

SELF DIAGNOSTICS message.

- The signal cable is not connected, or is loose. Check and secure the connection.

OUT OF FREQUENCY message appears.

- The frequency of the signal from the video card is outside the operating range of the monitor.

Horizontal Frequency : 30-70kHz



Vertical Frequency : 50-160Hz

- * Use the graphics board's utility software to change the frequency setting (Refer to the manual for graphics board).

The power LED is illuminated amber.

- Display power management mode.
- There is no active signal coming from the PC.
- The signal cable is not fastened securely.
- Check the computer power and graphics adapter configuration.

The image on the SCREEN is not centered, or too small, or not a rectangle shape.

- Image adjustment not been done yet in the current operating mode. Use the  and  buttons to set the image to your liking.

The monitor doesn't enter the power saving off mode (Amber).

- Computer video signal is not VESA DPMS standard. Either the PC or the video controller card is not using the VESA DPMS power management function.

An abnormal picture is displayed on the screen. For example, the upper part of the picture may be missing or dark.

- If using certain non-VESA Standard video card, an abnormal picture may be displayed. Try setting it to one of the factory preset modes, or selecting to a resolution and refresh rate within the specification limits of the monitor.

NOTE

- If the power indicator(LED) light is blinking amber, may result in abnormal condition of the monitor.
- Then press a power ON/OFF button on the front panel control and call your service technician for more information.



Picture Tube	17 inch (15.9 inches viewable) FST
	90 degree deflection
	0.27mm dot pitch
	ARAS(Anti-Reflective Anti-Static) coating
Sync Input	Horizontal Freq. 30 - 70kHz (Automatic)
	Vertical Freq. 50 - 160Hz (Automatic)
	Input Form Separate TTL, Positive/Negative
	Signal Input 15 pin D-Sub Connector
Video Input	Input Form Separate, RGB Analog, 0.7Vp-p/75 ohm, Positive
	Resolution(max) 1280 x 1024@60Hz
Audio	RMS Audio Output 1W+1W (R+L)
	Input Sensitivity 0.7 Vrms
	Built-in MIC E.C.M type (Electret Condenser Microphone)
	Speaker Impedance 8Ω
Power	Normal ≤ 100W
Consumption	Stand-by/Suspend ≤ 15W
	Power Off ≤ 5W
Dimensions (with tilt/swivel stand)	Width 46.5 cm / 18.3 inches
	Height 43.6 cm / 17.2 inches
	Depth 44.2 cm / 17.4 inches
Power Input	Europe AC 200-240V 50Hz 1.5A
	Others AC 100-240V 50/60Hz 2.0A
	The products should be used according to the Power requirements of each ID LABEL.
	Net 18.84 kg (41.53 lbs)
Environmental	Operating Condition
	Temperature 10 °C to 40 °C
	Humidity 10 % to 90 % non-Condensing
	Storage Condition
	Temperature 0 °C to 60 °C
Humidity 5 % to 90 % non-Condensing	