



# ROOM AIR CONDITIONER OWNER'S MANUAL

Please read the operating instructions and safety precautions carefully and thoroughly before installing and operating your room air conditioner.

# ACONDICIONADOR DE AIRE VENTANA DEL PROPIETARIO

es de operación y las precauciones  
lmente antes de instalar y operar  
ntana.



## Safety Precautions

Safety Precautions .....3

## About the Controls on the Air Conditioner

Controls .....5  
Air direction .....6  
Care and Maintenance .....6

## Features

Features .....7  
Electrical Data .....8

### **Before you call for service...**

Normal Operation .....9  
Abnormal Operation .....9

## FOR YOUR RECORDS

Write down the model and serial numbers here:

**Model #**

**Serial #**

You can find them on a label on the side of each unit.

**Dealer's Name**

**Date Purchased**

## READ THIS MANUAL

Inside you will find many helpful hints on how to use and maintain your air conditioner properly. Just a little preventive care on your part can save you a great deal of time and money over the life of your air conditioner.

You'll find many answers to common problems in the chart of troubleshooting tips. If you review our chart of **Troubleshooting Tips** first, you may not need to call for service at all.

## CAUTION



- Contact the authorized Service technician for repair or maintenance of this unit.
- The air conditioner is not intended for use by young children or infirm persons without supervision.
- Young children should be supervised to ensure that they do not play with the air conditioner.





# Safety Precautions

To prevent injury to the user or other people and property damage, the following these instructions.

■ Incorrect operation due to ignoring of instruction will cause harm or damage. The seriousness is classified by the following indications.

|   |  |
|---|--|
|  | <b>WARNING</b> : This symbol indicates the possibility of death or serious injury.             |
|  | <b>CAUTION</b> : This symbol indicates the possibility of injury or damage to properties only. |

■ Meanings of symbols used in this manual are as shown below.

|   |   |
|---|---|
|  | <b>Be sure not do this.</b>               |
|  | <b>Be sure to follow the instruction.</b> |

## **WARNING**

• Otherwise, it will cause electric shock or fire due to heat generation.

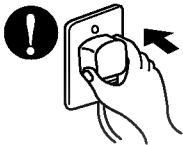

• It will cause electric shock or fire due to heat generation.



• It will cause electric shock or fire.  
• If the power cord is damaged, it must be replaced by the manufacturer or its service agent or a similarly qualified person in order to avoid a hazard.

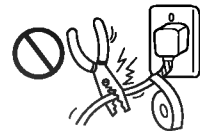

• It will cause electric shock or fire due to heat generation.

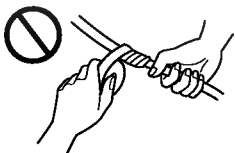

• It will cause electric shock.



• This could damage your health.

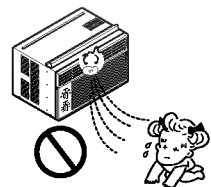



## CAUTION

- They are sharp and may cause an injury.

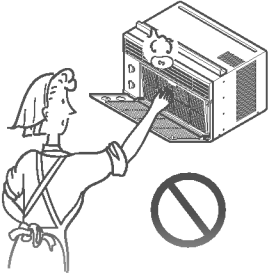

- Water may enter the unit and degrade the insulation. It may cause an electric shock.

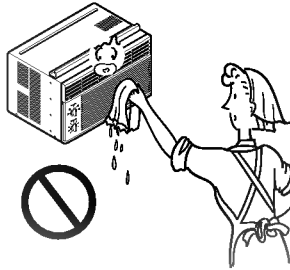

- Since the fan rotates at high speed during operation, it may cause an injury.

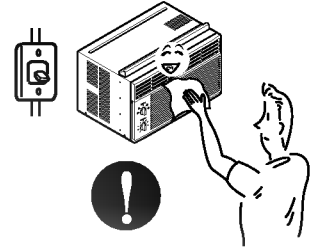

- This could injure the pets or plants.

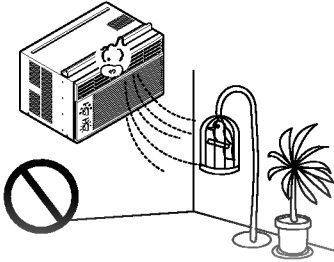

- Do not use this air conditioner to preserve precision devices, food, pets, plants, and art objects. It may cause deterioration of quality, etc.

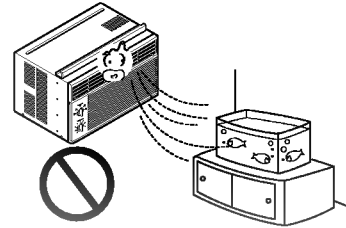

- It may cause an electric shock.

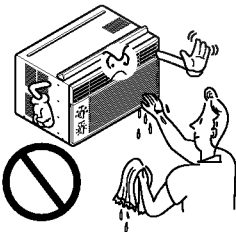

- It may cause a fire or deformation of the cabinet.

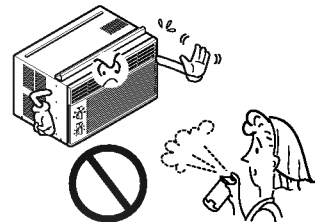

# About the Controls on the air conditioner

The controls will look like one of the following.

## Controls

|                          |                          |   |
|--------------------------|--------------------------|---|
| <p><b>Operation</b></p>  | <p><b>Operation</b></p>  | <p>Off ( 0 ) - Turns air conditioner off.<br/>           High Fan ( ⊕ ) - High speed fan operation without cooling.<br/>           Low Fan ( ⊗ ) - Low speed fan operation without cooling.<br/>           High Cool ( * ) - Cooling with high speed fan operation.<br/>           Low Cool ( * ) - Cooling with low speed fan operation.</p> |
| <p><b>Thermostat</b></p> | <p><b>Thermostat</b></p> | <p>This automatically controls the temperature of the indoor air.<br/>           Turn the knob so that arrow points to the larger marks for greater cooling. Point the arrow to the smaller marks for more moderate cooling.<br/>           (i.e. the higher number the greater cooling)</p>  |

### • FOR NORMAL COOLING

1. Turn the Operation switch to the High Cool ( \* ) or the Low Cool ( \* ) setting.
2. Set the Thermostat control to the desired temperature mark 5 (the mid-point is a good starting position). If the room temperature is not satisfactory after a reasonable time, adjust the control to a cooler or warmer setting, as appropriate.

### • FOR MAXIMUM COOLING

1. Turn the Operation switch to the High Cool ( \* ) setting.
2. Set the Thermostat control to the largest 9 temperature mark.

### • FOR QUIETER OPERATION

1. Turn the Operation switch to the Low Cool ( \* ) setting.
2. Set the Thermostat control as needed.

### • CAUTION

When the air conditioner has been performed its cooling operation and is turned off or set to the fan position, wait at least 3 minutes before resetting to the cooling operation again.

## Additional controls and important information.

### Air Direction

#### • ADJUSTING THE AIR DIRECTION USING THE HORIZONTAL AIR-DEFLECTOR CONTROL

Using the control tabs, the air flow can be directed to the left, right, straight ahead, or any combination of these directions.

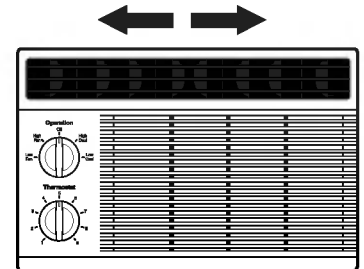

### Care and Maintenance

TURN THE AIR CONDITIONER OFF AND REMOVE THE PLUG FROM THE POWER OUTLET.

#### • TO CLEAN FILTER

The air filter will become dirty as it removes dust from the inside air. It should be washed at least every 2 weeks. If the air filter remains full of dust, the air flow will decrease and the cooling capacity will be reduced, possibly damaging the unit.

1. Pull the inlet grille forward and pull out the air filter. (Fig. 1)
2. Wash the air filter in warm 104°F (40°C) water. Be sure to shake off all the water before replacing the filter.

Do not force open or open too far (about 56°)

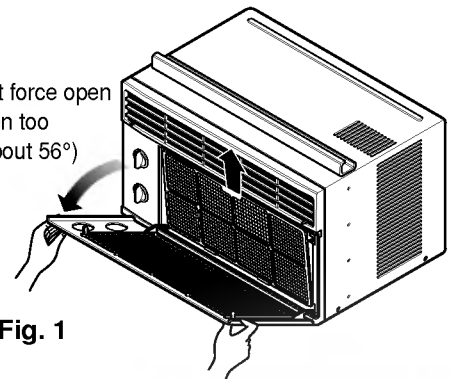

Fig. 1

#### • CLEANING THE AIR CONDITIONER

The front grille and Inlet grille may be wiped with a cloth dampened in a mild detergent solution. (Fig. 2) The cabinet may be washed with mild soap or detergent and lukewarm water, then polished with Liquid Wax for Appliances.

To ensure continued peak efficiency, the condenser coils (outside of unit) should be checked periodically and cleaned if clogged with soot or dirt from the atmosphere.

#### • HOW TO REMOVE THE FRONT GRILLE

1. Remove the thermostat knob and the operation knob by pulling.
2. Remove the screw securing the Front Grille. (Fig. 3)
3. Push the grille up from the bottom and pull the top of the grille away from the case as the top tabs lift out of their slots. (Fig. 4)

Fig. 2

Fig. 3

Fig. 4

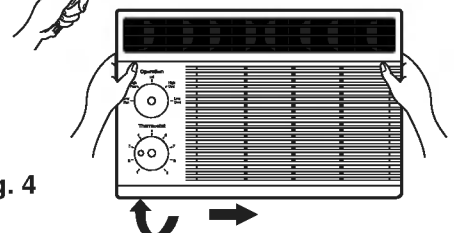
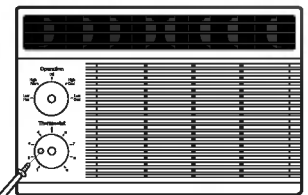
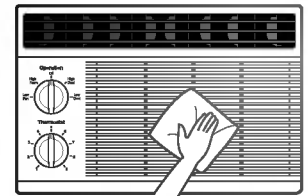

# Features

Learning parts name prior to installation will help you understand the installation procedure.

## Features

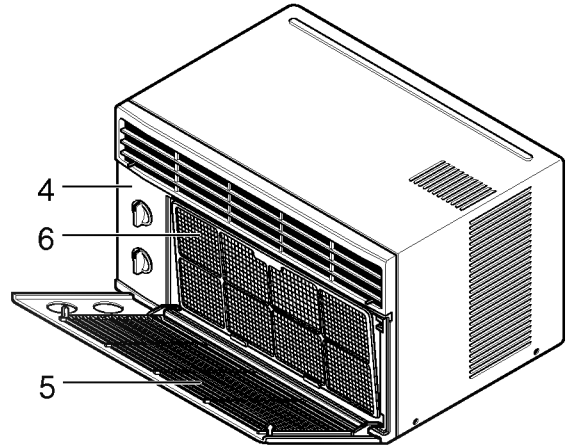
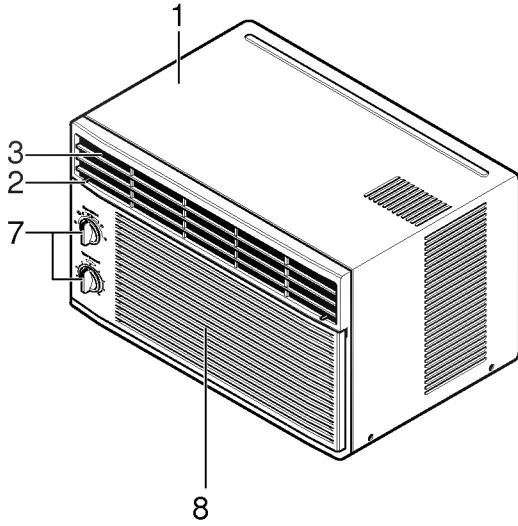

- 1. CABINET
- 2. HORIZONTAL AIR DEFLECTOR
- 3. COOL AIR DISCHARGE
- 4. FRONT GRILLE



- 5. INLET GRILLE
- 6. AIR FILTER
- 7. KNOBS
- 8. AIR INTAKE

### How to Secure the Drain pipe

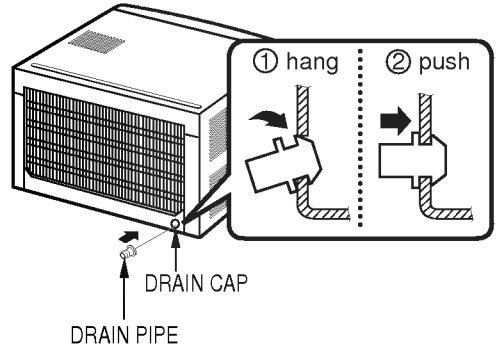
In humid weather, excess water may cause the BASE PAN to overflow. To drain the water, remove the DRAIN CAP and secure the DRAIN PIPE to the rear hole of the BASE PAN.

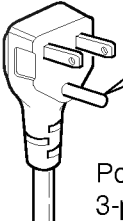

### Electrical Data

| Line Cord Plug   | Use Wall Receptacle  | Power Supply   |
|--|--|--|
|  <p>Do not under any circumstances cut or remove the grounding prong from the plug.</p> <p>Power supply cord with 3-prong grounding plug</p> |  <p>Standard 125V, 3-wire grounding receptacle rated 15A, 125V AC</p> | <p>Use 15 AMP, time delay fuse or circuit breaker.</p> |





# Before you call for service...

Troubleshooting Tips save time and money!  
Review the chart below first and you may not need to call for service.

## Normal Operation

- You may hear a pinging noise caused by water being picked up and thrown against the condenser on rainy days or when the humidity is high. This design feature helps remove moisture and improve efficiency.
- You may hear the thermostat click when the compressor cycles on and off.
- Water will collect in the base pan during high humidity or on rainy days. The water may overflow and drip from the outdoor side of the unit.
- The fan may run even when the compressor does not.

## Abnormal Operation

|   |   |  |
|---|---|--|
| <b>Air conditioner does not start</b>             | ■ <i>The air conditioner is unplugged.</i>  | • Make sure the air conditioner plug is pushed completely into the outlet.   |
|   | ■ <i>The fuse is blown/circuit breaker is tripped.</i>                                | • Check the house fuse/circuit breaker box and replace the fuse or reset the breaker.  |
|   | ■ <i>Power failure.</i>   | • If power failure occurs, turn the mode control to <b>Off</b> . When power is restored, wait 3 minutes to restart the air conditioner to prevent tripping of the compressor overload. |
| <b>Air conditioner does not cool as it should</b> | ■ <i>Airflow is restricted.</i>   | • Make sure there are no curtains, blinds, or furniture blocking the front of the air conditioner.   |
|   | ■ <i>The THERMOSTAT may not be set high enough.</i>                                   | • Turn the knob to a higher number. The highest setting provides maximum cooling.  |
|   | ■ <i>The air filter is dirty.</i>   | • Clean the filter at least every 2 weeks. See the care and Maintenance section.   |
|   | ■ <i>The room may have been hot.</i>  | • When the air conditioner is first turned on, you need to allow time for the room to cool down.   |
|   | ■ <i>Cold air is escaping.</i>  | • Check for open furnace floor registers and cold air returns.   |
| <b>Air conditioner freezing up</b>                | ■ <i>Cooling coils have iced up.</i>  | • See Air Conditioner Freezing Up below.   |
|   | ■ <i>Ice blocks the air flow and stops the air conditioner from cooling the room.</i> | • Set the mode control at High Fan or High Cool with thermostat at 1 or 2.   |

