

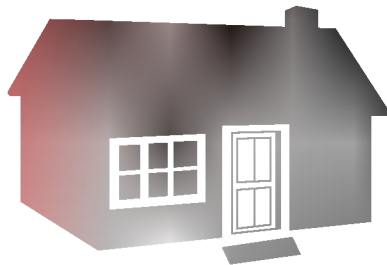

# SUPRA

## USER MANUAL

MODEL: SRF 3690MFCD  
REFRIGERATOR



*“Thank you  
for bringing home a SUPRA.”*

**SUPRA CORPORATION**

P/No. 3828JD8344P

┌

|

**MEMO**

└

|

---

# **CONTENTS**

<b>INSTALLATION .....</b>	<b>4</b>
<b>INNER PARTS .....</b>	<b>5</b>
<b>OPERATIONS .....</b>	<b>6</b>
Starting	
Display panel & Function Buttons	
Door Alarm	
Self Test	
Focused Cooling	
Super Ice Making System	
Super Cool	
Super Freeze	
Temperature Control	
Ice Making	
Fresh meat	
Defrosting	
Deodorizer(Optional)	
Water Dispenser(Optional)	
<b>SUGGESTIONS ON FOOD STORAGE .....</b>	<b>14</b>
<b>CLEANING .....</b>	<b>15</b>
<b>GENERAL INFORMATION .....</b>	<b>15</b>
<b>LAMP REPLACEMENT .....</b>	<b>16</b>
<b>IMPORTANT WARNINGS .....</b>	<b>16</b>
<b>BEFORE CALLING FOR SERVICE .....</b>	<b>17</b>
<b>MEMO .....</b>	<b>19</b>

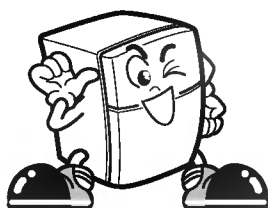

## INSTALLATION

### SELECT A GOOD LOCATION

1. Place your refrigerator where it is easy to use.
2. Avoid placing the refrigerator near heat sources, direct sunlight or moisture.
3. Air must circulate properly around your refrigerator to ensure efficient operation.  
If your refrigerator is placed in a recessed area in the wall, allow at least a 12 inch(30 cm) or greater clearance above the refrigerator and 2 inches(5 cm) or more from the wall.  
The refrigerator should be elevated 1 inch(2.5 cm) from the floor, especially if it is carpeted.

4. To avoid vibrations, the refrigerator must be leveled. If necessary, adjust the leveling screw(s) to compensate for unevenness of the floor.  
To make closing the doors easily, the front should be slightly higher than the rear.  
Leveling screw(s) can be turned easily by tipping the cabinet slightly.  
Turn the leveling screw(s) clockwise to raise the refrigerator, counterclockwise to lower it.
5. Don't install this appliance below 5 °C. It may cause the debasement of the refrigerator.

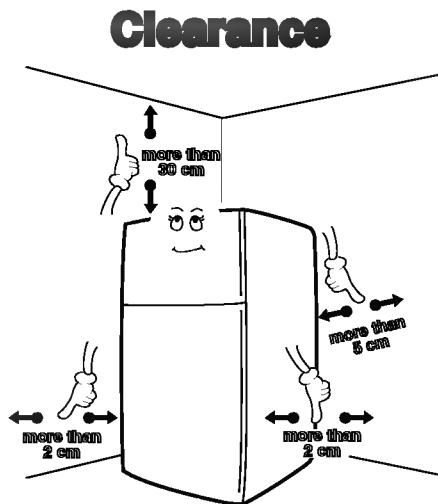

### NEXT

1. Wipe off all dust accumulated during shipping and clean your refrigerator thoroughly.
2. Install accessories such as the ice cube box, cover evaporation tray, etc., in their proper places. They are packed together to prevent possible damage during shipping.
3. Connect the power supply cord(or plug)to the outlet. Don't double up with other appliances on the same outlet.
4. Prior to use, let the refrigerator run for 2-3 hours. Check the flow of cold air in the freezer compartment to ensure proper cooling has taken place.  
Your refrigerator is now ready for use.

# INNER PARTS

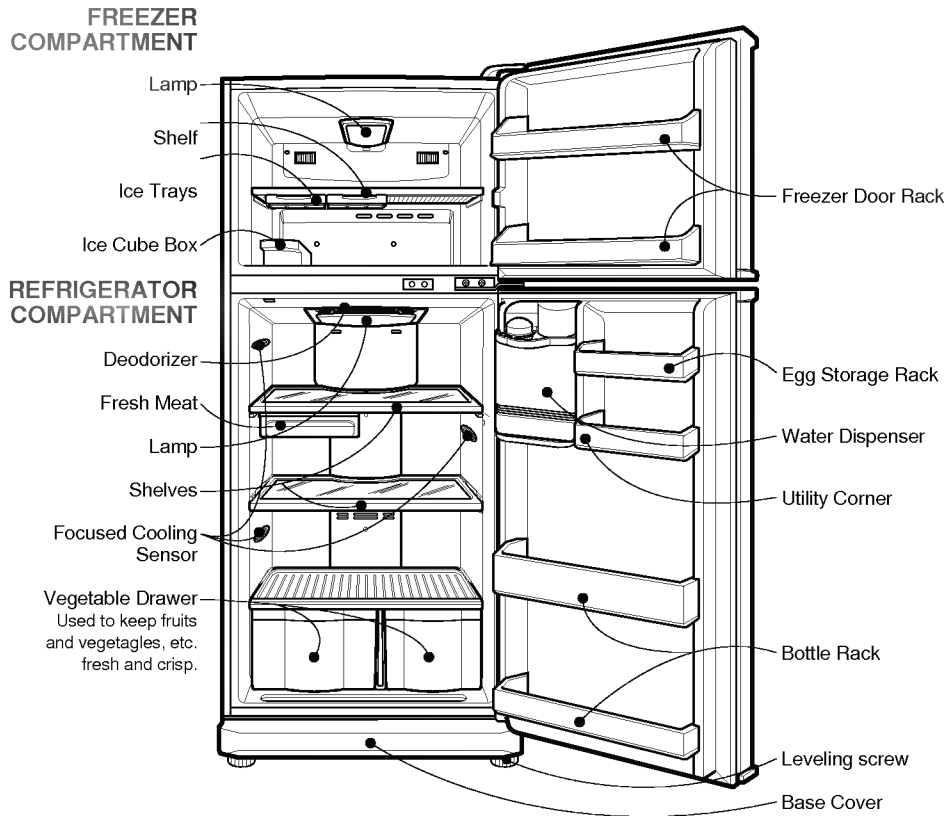

• If you found some parts missing from your unit, they may be parts only used in other models.

## STARTING

When your refrigerator is first installed, allow it 2-3 hours to stabilize at normal operation temperatures prior to filling it with fresh or frozen foods.

If operation is interrupted, wait 5 minutes before restarting.

## DISPLAY PANEL & FUNCTION BUTTONS

### • Super Freeze Button

can be used when you freeze food or ice more quickly than normal state. Whenever you press this button, the function is on and off.

If the function is on, the super freeze leds are on after not pressing 3 times.

### • Super Cool Button

is used to keep in cold storage more quickly and effectively.

Whenever you press this button, the function is on and off.

If the function is on, the super cool leds are on after shifting 3 times.

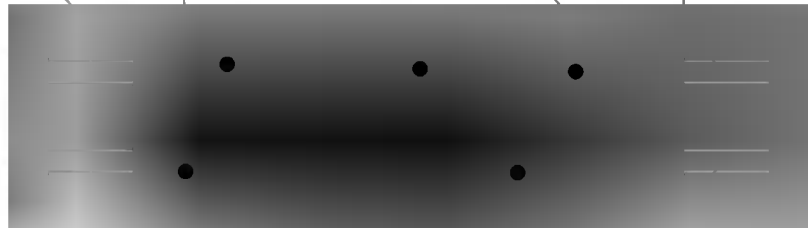
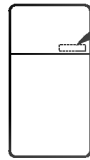

### • Focused Cooling

leds turn on if the door is opened and focused cooling returns the normal state a few minutes after door is closed. All leds are off after certain minutes.

## OPERATIONS

### DOOR ALARM

When the door of the refrigerator or the freezer is left opened for a while, the alarm sounds three times 1 minute after and then three times every 30 seconds.

### SELF TEST

- When a trouble is occurred, this function indicates it. In this case, if you press any operating button, the refrigerator does not operate and displays abnormal.
- At this time, don't disconnect the power cord from the outlet and inquire to the service center.
- If you press the 'FRZ. TEMP' button and 'SUPER FREEZER' button at the same time for 2 seconds over, all lamps on control panel turn on. It checks only the function, not trouble. Unpressing the two buttons, it turns to the normal condition.

### FOCUSED COOLING

- When you insert new(warmer) food on a shelf, a focused cooling sensor's senses it and blows out the cooling air concentrically. So the food is cooled more quickly.
- If you insert some food on the 'shelf 2', the 'sensor 2' senses it and blows out the cooling air focusingly at 'shelf 2'.
- The 'Focused Cooling System' operates automatically.
- You can cool more effectively as put the food near to a sensor.

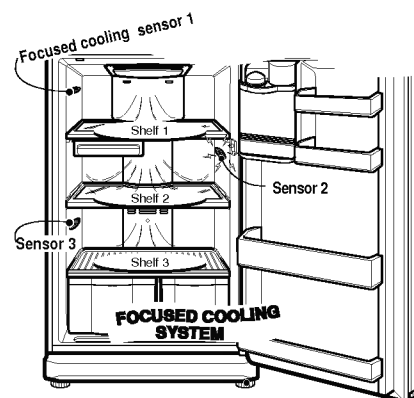

## SUPER COOL

- This refrigerator can be operated the cooling fan two speed (rpm),-'normal' and 'quick'-with 'Super Cool System'. You can cool the food more quickly because the cooling fan can operate a quick speed.
- The super cool system operates, when the power is supplied first. So, you can store food more fresh. The super cool system is released when the temperature of refrigerator compartment get specified degree.
- If needed press the 'SUPER COOL' button on the display panel.  
The function on and off whenever the button is pressed.  
The function is released(off) if you don't cease the function and the food is cooled sufficiently.

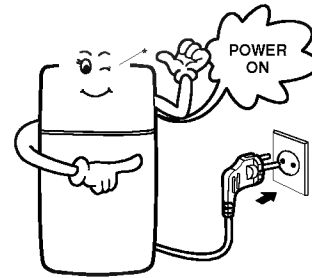

## SUPER FREEZE

- This function can be used when you want to freeze food or water more quickly.
- Press the 'SUPER FREEZE' button on the display panel and the super freeze system is on. This function is on and off whenever the button is pressed. The function is released(off)if you don't cease the function and pass some hour(about 3 hours)
- The noise can be increased instantly because of the quick speed of the fan.



## TEMPERATURE CONTROL

You can set each compartment temperature using the 'REF.TEMP' and 'FRZ.TEMP' button.

Whenever pressing the button, the LEDs emit light two steps. The temperature of each compartment is lowered as each LEDs luminesce from "COLD" to "COLDEST".

You can select the desired setting point five steps COLD to the COLDEST).

For the economic electricity, set each leds to the 'COLD' position.



## ICE MAKING

- To make ice cubes, fill the ice tray with water and place it in the freezer.
- To remove ice cubes, hold the tray at its ends twist gently.

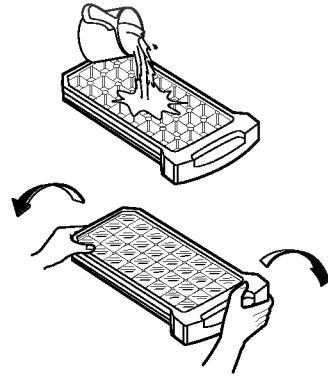

- To remove ice cubes easily, run water on the tray before twisting.

## FRESH MEAT

- When the door is opened, the warmer air don't influence in the fresh meat. So you can store food more fresh in it.
- The shelf and inserted fresh meat must be placed at its position. If it is moved. the fresh meat can't fill the role of it.

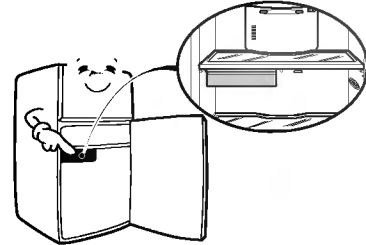

## DEFROSTING

- Defrosting takes place automatically.
- The defrosted water flows down to the evaporating tray which located in the lower back side of the refrigerator and is evaporated automatically.

## DEODORIZER(OPTIONAL)

- By using an "TiO<sub>2</sub> catalyst" deodorizing performance is guaranteed.
- Unpleasant odor of food in fresh food compartment is deodorized with no harm to you and the food.

### How to use

- As the catalyst is located in cooling air outlet for circulating air in fresh food compartment, there is no need for any handling.
- Do not prick the cooling air outlet with a sharp tip because the deodorizing catalyst may be damaged.
- When storing food with a strong odor, wrap it or store it in a container with a lid because odor may be passed on to other foods.

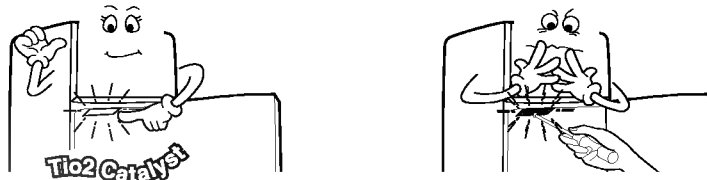

### Re-using of the Catalyst

Used some length and the odor is strong, the catalyst can be revived and re-used. Separate deodorizer in ceiling of refrigerator compartment, dry using hair drier to remove moisture or malodor and oxidize under sunlight to decomposing malodor by ultraviolet.

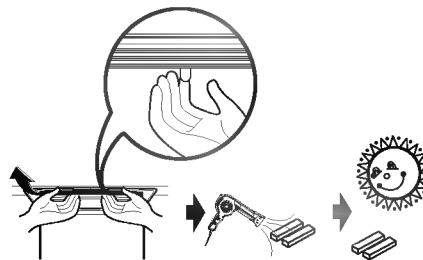

## OPERATIONS(water dispenser)

### WATER DISPENSER(OPTIONAL)

#### Features

##### ▶ EXTERIOR

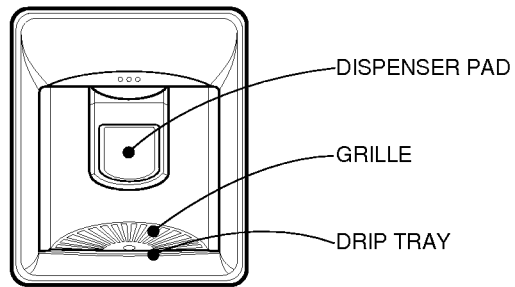

##### ▶ INTERIOR

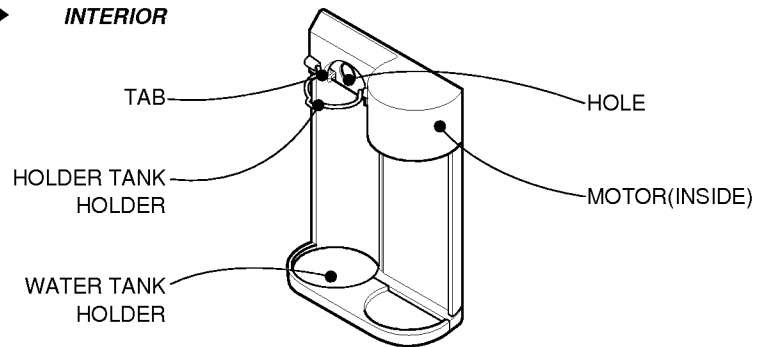

##### ▶ WATER TANK

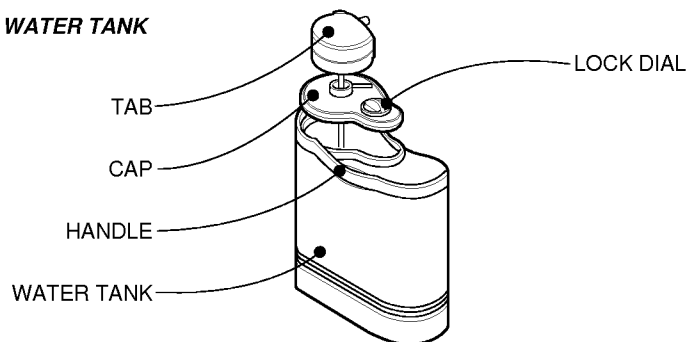

## OPERATIONS(water dispenser)

### Putting The Water In The Water Tank

- 1 Turn the lock dial in the direction of the arrow as shown to remove it and pour water into the dispenser water tank.

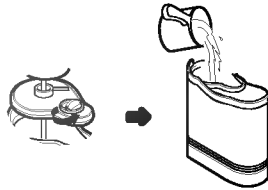

- 2 Close the cap by tilting it and putting one side in first and then the other side as shown.



- 3 Place the water tank in the tank holder inside the refrigerator. Make sure that the groove on the connecting part is in position with the tab. Push the connecting part into the hole until it "Clicks".

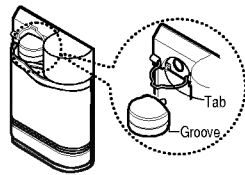

- 4 Fix the connecting part in place by means of the holder ring as shown.

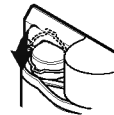

- Do not use anything other than water including soft drinks, milk and juice.
- Hot water needs to be cooled before being put in the water tank.
- Always use the holder ring to fix the water tank in place to prevent the tank from moving or getting loose.

### Drinking

- 1 Press the dispenser pad with the glass.



- 2 The water is released when the dispenser pad is pressed. The pad returns to its original position when the glass is removed, and the water stops its flow.

- The motor rotates in reverse for a few seconds after the dispenser is released to dispose of any water remaining in the tubes.(This may cause the sound of water being sucked back inside)

## CLEANING

### Grille and Drip Tray

1 Pull the drip tray out and remove with the grille.

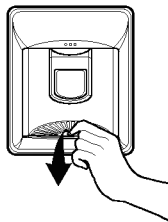

## PULIZIA DEL DISPENSER

### Griglia e cassetto

2 Dispose of the water in the kitchen sink, wash the drip tray and the grille with a mild detergent and rinse thoroughly.

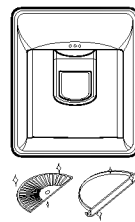

### Water Tank

1 Remove the cap.



2 Clean the inside and outside of the water tank with dishwashing detergent and rinse thoroughly under running water.

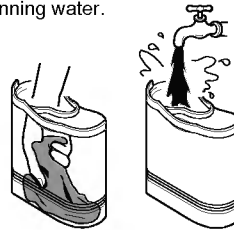

### Other Parts

Remove the cap and clean the cap and connecting part with a mild detergent and rinse thoroughly.

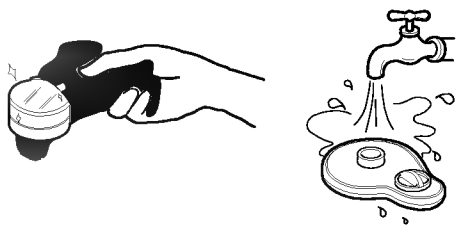

- Use lukewarm water when cleaning.
- Do not use anything other than water. If it is used with soft drinks, put water in the water tank and discharge three or four cups of water shortly.

## ***SUGGESTIONS ON FOOD STORAGE***

### **STORING FOOD**

- Store fresh food in the refrigerator compartment. How food is frozen and thawed is an important factor in maintaining its freshness and flavor.
- Do not store food which goes bad easily at low temperatures, such as bananas, pineapples, and melons.
- Allow hot food to cool prior to storing. Placing hot food in the refrigerator could spoil other food, and lead to higher electric bills!
- When storing the food, cover it with vinyl wrap or store in container with a lid. This prevents moisture from evaporating, and helps food to keep its taste and nutrients.
- Do not block air vents with food. Smooth circulation of chilled air keeps refrigerator temperatures even.
- Do not open the door frequently. Opening the door lets warm air enter the refrigerator, and cause temperatures to rise.

### **FREEZER COMPARTMENT**

- Do not store bottles in the freezer compartment—they may break when frozen.
- Do not refreeze food that has been thawed. This causes loss of taste and nutrition.
- When storing frozen food like ice cream for a long period, place it on the freezer shelf, not in the door rack.

### **REFRIGERATOR COMPARTMENT**

- Avoid placing moist food deep inside refrigerator shelves, it could freeze upon direct contact with chilled air.
- Always clean food prior to refrigeration. Vegetables and fruits should be washed and wiped, and packed food should be wiped clean, to prevent adjacent food from spoiling.
- When storing eggs in their storage rack, ensure that they are fresh, and always store them in a up-right position, which keeps them fresh longer.

It is important that your refrigerator be kept clean to prevent undesirable odors. Spilled food should be wiped up immediately, since it may acidify and stain plastic surfaces if allowed to settle.

Never use metallic scouring pads, brushes, coarse abrasive cleaners or strong alkaline solutions on any surface.

Before you clean, however, remember that damp objects will stick or adhere to extremely cold surfaces. Do not touch frozen surfaces with wet or damp hands.

**EXTERIOR** - Use a lukewarm solution of mild soap or detergent to clean the durable finish of your refrigerator. Wipe with a clean, damp cloth and then dry.

**INTERIOR** - Regular cleaning of the interior and interior parts is recommended. If you have the No Frost model which defrosts automatically, leave both doors open during the entire cleaning process. Disconnect the power supply, and remove food and all compartment shelves, storage trays etc. Wash all compartments with a baking soda solution. Rinse and dry.

**INTERIOR PARTS** - Wash compartment shelves, door racks, storage trays and magnetic door seals etc. with the baking soda solution or a mild detergent and warm water. Rinse and dry.

### WARNING

Always remove power cord from the wall outlet prior to cleaning in the vicinity of electrical parts (lamps, switches, controls, etc.). Wipe up excess moisture with a sponge or cloth to prevent water or liquid from getting into any electrical part and causing electric shock. Do not use flammable or toxic cleaning liquids.

## VACATION TIME

During average length vacations, you will probably find it best to leave the refrigerator in operation. Place freezable items in freezer for longer life. When you plan to be away for an extended period, remove all food, disconnect the power cord, clean the interior thoroughly, and leave each door OPEN to prevent odor formation.

## POWER FAILURE

Most power failures are corrected in an hour or two and will not affect your refrigerator temperatures. However, you should minimize the number of door openings while the power is off. During power failures of longer duration, place a block of dry ice on top of your frozen packages.

## IF YOU MOVE

Remove or securely fasten down all loose items inside the refrigerator. To avoid damaging the leveling screw(s), turn them all the way into the base.

## ANTI-CONDENSATION PIPE

The outside wall of the refrigerator cabinet may sometimes get warm, especially just after installation. Don't be alarmed. This is due to the anti-condensation pipe, which pumps hot refrigerant to prevent "sweating" on the outer cabinet wall.

Anti-Condensation Pipe

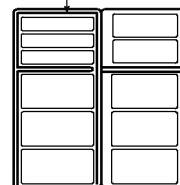

### FREEZER LAMP

1. Unplug the power cord from the outlet.
2. Remove the room lamp lid by taking down while pulling it forward with your hand after inserting finger into the inside hole as shown in the figure at right.
3. Remove the lamp by turning it counterclockwise and replace new one.
4. Assemble in reverse order of disassembly. Replacement bulb must be the same specification as original.



### REFRIGERATOR LAMP

1. Unplug the power cord from the outlet.
2. Remove the up most refrigerator shelf.
3. Remove the room lamp lid by taking down while pulling it forward with your hand after inserting finger into the inside hole as shown in the figure at right.
4. Turn the lamp counterclockwise and replace new one.
5. Assemble in reverse order of disassembly. Replacement bulb must be the same specification as original.

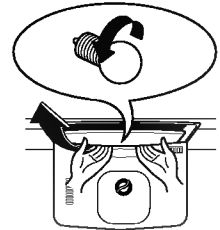

### DO NOT USE EXTENSION CORD

If possible, connect the refrigerator to its own individual electrical outlet to prevent it and other appliances or household lights from causing an overload that could cause a power outage.

### POWER CORD REPLACEMENT

If the supply cord is damaged, it must be replaced by a special cord or assembly available from the manufacturer or its service agent.

### ABOUT GROUNDING(EARTHING)

In the event of an electric short circuit, grounding(earthing) reduces the risk of electric shock by providing an escape wire for the electric current.

In order to prevent possible electric shock, this appliance must be grounded.

Improper use of the grounding plug can result in an electric shock. Consult a qualified electrician or service person if the grounding instructions are not completely understood, or if you have doubts on whether the appliance is properly grounded.

### VERY DANGEROUS ATTRACTION

An empty refrigerator can be a dangerous attraction to children. Remove either gaskets, latches, lids or the entire door from your unused appliance, or take some other action to make it harmless.

**This appliance must be grounded(earthed).**

**DON'T WAIT! DO IT NOW!**

**Do not store inflammable materials, explosives or chemicals in the refrigerator.**



## BEFORE CALLING FOR SERVICE

SERVICE CALLS CAN OFTEN BE AVOIDED!  
IF YOU FEEL YOUR REFRIGERATOR IS NOT OPERATING PROPERLY, CHECK THESE POSSIBLE CAUSES FIRST:

<b>PROBLEM</b>	<b>POSSIBLE CAUSES</b>
<u>REFRIGERATOR DOES NOT OPERATE</u>	<ul style="list-style-type: none"><li>• Has a house fuse blown or circuit breaker tripped?</li><li>• Has the power cord plug been removed or loosened from the electrical wall outlet?</li></ul>
<u>REFRIGERATOR OR FREEZER COMPARTMENT TEMPERATURE TOO WARM</u>	<ul style="list-style-type: none"><li>• Temperature control not set on proper position.</li><li>• Appliance is placed close to wall or heat source.</li><li>• Warm weather-frequent door openings.</li><li>• Door left open for a time.</li><li>• Large amount of foods are kept in the refrigerator.</li></ul>
<u>ABNORMAL NOISE(S)</u>	<ul style="list-style-type: none"><li>• Refrigerator is installed in a weak or uneven place, or leveling screw needs adjusting.</li><li>• Unnecessary objects placed in the back side of the refrigerator.</li></ul>
<u>REFRIGERATOR HAS ODOR</u>	<ul style="list-style-type: none"><li>• Foods with strong odors should be tightly covered or wrapped.</li><li>• Interior needs cleaning</li></ul>
<u>DEW FORMS ON THE CABINET SURFACE</u>	<ul style="list-style-type: none"><li>• Not unusual during periods of high humidity.</li><li>• Door may have been left ajar.</li></ul>



**SUPRA CORPORATION**  
10F, IRIMAJIRI BLDG,  
6-40 SHIN-OGAWACHO,  
SHINJUKU-KU, TOKYO 162, JAPAN

