



MICROWAVE/ GRILL/ CONVECTION OVEN

OWNER'S MANUAL

PLEASE READ THIS OWNER'S MANUAL THOROUGHLY BEFORE OPERATING.



MC-805CLR

Precautions

Precautions to avoid possible exposure to excessive microwave energy.

You cannot operate your oven with the door open due to the safety interlocks built into the door mechanism. These safety interlocks automatically switch off any cooking activity when the door is opened; which in the case of a microwave oven could result in harmful exposure to microwave energy.

It is important not to tamper with the safety interlocks.

Do not place any object between the oven front face and the door or allow food or cleaner residue to accumulate on sealing surfaces.

Do not operate your oven if it is damaged. It is particularly important that the oven door closes properly and that there is no damage to the: (1) door(bent), (2) hinges and latches (broken or loosened), (3) door seals and sealing surfaces.

Your oven should not be adjusted or repaired by anyone except qualified service personnel.

Warning



When heating liquids, e.g. soups, sauces and beverages in your microwave oven, delayed eruptive boiling can occur without evidence of bubbling. This could result in a sudden boil over of the hot liquid. To prevent this possibility the following steps should be taken:

- 1 Avoid using straight sided containers with narrow necks.
- 2 Do not overheat.
- 3 Stir the liquid before placing the container in the oven and again halfway through the heating time.
- 4 After heating, allow to stand in the oven for a short time, stir or shake them(especially the contents of feeding bottles and baby food jars) again carefully and check the temperature of them before consumption to avoid burns (especially, contents of feeding bottles and baby food jars). Be careful when handling the container.

Warning

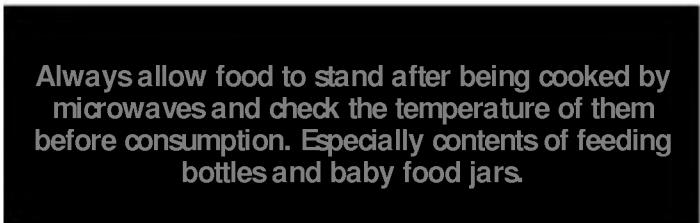

How the Microwave Oven Works

Microwaves are a form of energy similar to radio and television waves and ordinary daylight. Normally, microwaves spread outwards as they travel through the atmosphere and disappear without effect. Microwave ovens, however, have a magnetron which is designed to make use of the energy in microwaves. Electricity, supplied to the magnetron tube, is used to create microwave energy.

These microwaves enter the cooking area through openings inside the oven. A turntable or tray is located at the bottom of the oven. Microwaves cannot pass through metal walls of the oven, but they can penetrate such materials as glass, porcelain and paper, the materials out of which microwave-safe cooking dishes are constructed.

Microwaves do not heat cookware, though cooking vessels will eventually get hot from the heat generated by the food.

A very safe appliance

Your microwave oven is one of the safest of all home appliances. When the door is opened, the oven automatically stops producing microwaves. Microwave energy is converted completely to heat when it enters food, leaving no “left over” energy to harm you when you eat your food.

Precautions	2
Contents	3
Unpacking & Installing	4 ~ 5
Setting the Clock	6
Child Lock	7
Micro Power Cooking	8
Micro Power Level	9
Two Stage Cooking	10
Quick Start	11
More or Less Cooking	12
Grill Cooking	13
Convection Cooking	14 ~ 15
Combination Cooking	16 ~ 17
Auto Defrost	18 ~ 19
Auto Cook	20 ~ 21
Auto Roast Cook	22 ~ 23
Potisserie	24 ~ 25
Safety precautions	26
Microwave - safe Utensils	27
Food characteristics & Microwave cooking	28 ~ 29
Questions & Answers	30
Plug Wiring Information/ Technical Specifications	31

Unpacking & Installing

By following the basic steps on these two pages you will be able to quickly check that your oven is operating correctly. Please pay particular attention to the guidance on where to install your oven. When unpacking your oven make sure you remove all accessories and packing. Check to make sure that your oven has not been damaged during delivery.

- 1** Unpack your oven and place it on a flat level surface.

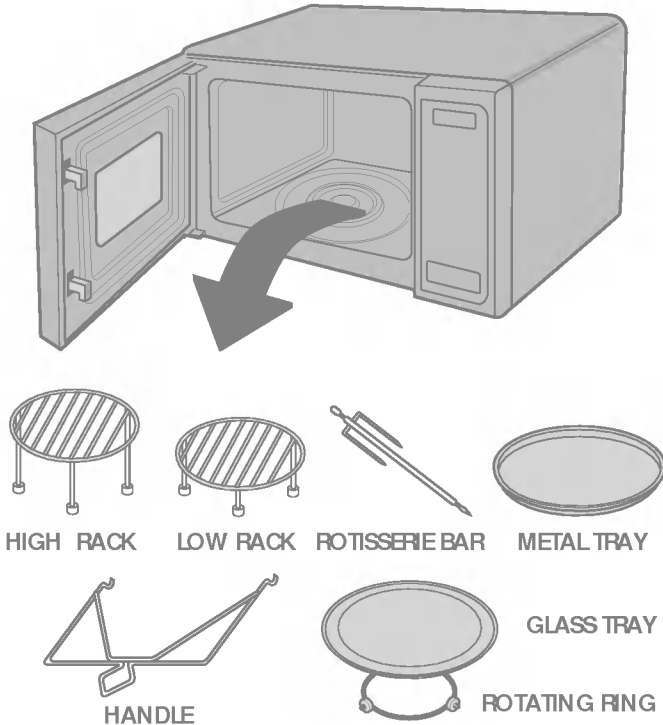

- 2** Place the oven in the level location of your choice with more than 85cm height but make sure there is at least 30cm of space on the top and 10cm at the rear for proper ventilation. The front of the oven should be at least 8cm from the edge of the surface to prevent tipping. An exhaust outlet is located on top or side of the oven. Blocking the outlet can damage the oven.

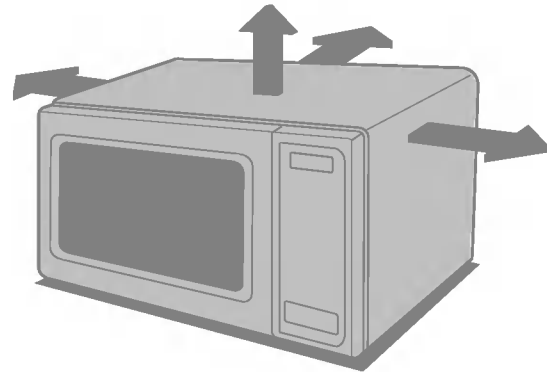

THIS OVEN SHOULD NOT BE USED FOR COMMERCIAL CATERING PURPOSES

3 Plug your oven into a standard household socket. Make sure your oven is the only appliance connected to the socket. **If your oven does not operate properly, unplug it from the electrical socket and then plug it back in.**

4 Open your oven door by pressing the **DOOR OPEN** button. Place the **ROTATING RING** inside the oven and place the **GLASS TRAY** on top.

5 Fill a **microwave safe container** with 300 ml (1/2 pint) of water. Place on the **GLASS TRAY** and close the oven door. If you have any doubts about what type of container to use please refer to page 27.

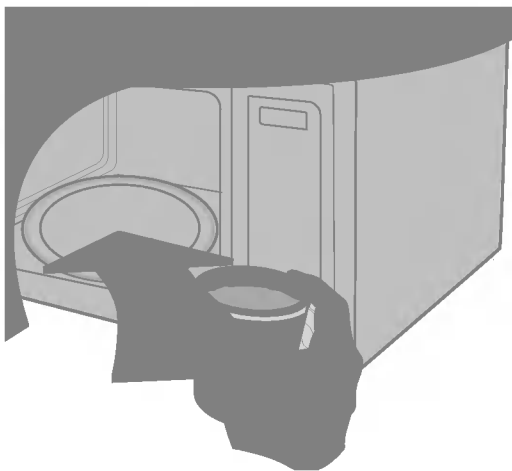

6 Press the **START** button six times to set 3 minutes of cooking time. You will hear a BEEP each time you press the button. Your oven will start before you have finished the sixth press; don't worry this is normal.



7 The **DISPLAY** will count down from 3 minutes. When it reaches 0 it will sound BEEPS. Open the oven door and test the temperature of the water. If your oven is operating the water should be warm. **Be careful when removing the container it may be hot.**

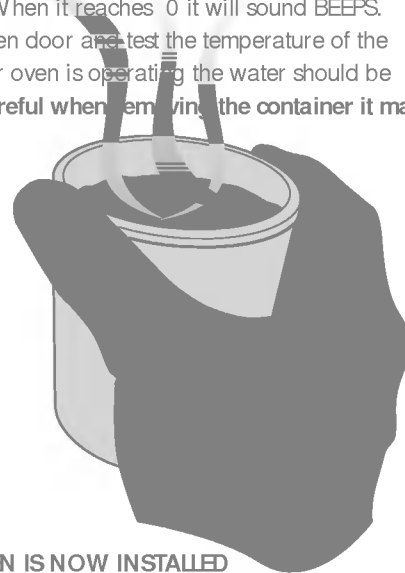

YOUR OVEN IS NOW INSTALLED

Setting the Clock



When your oven is plugged in for the first time or when power resumes after a power cut, a '0' will be shown in the display; you will have to reset the clock.

If the clock (or display) shows any strange looking symbols, unplug your oven from the electrical socket and plug it back in and reset the clock.

During clock setting the colon will flash. After setting, the colon will stop flashing.

You can set either 12 hour clock or 24 hour clock.

In the following example I will show you how to set the time for 14:35 when using the 24 clock. Make sure that you have removed all packaging from your oven.

Make sure you have correctly installed your oven as described earlier in this book

Press **STOP/ CLEAR**.



Press **CLOCK** once.

(If you want to set a 12 hour clock, Press **CLOCK** once more. If you want to change different option after setting clock, you have to unplug and plug it back in.)



Press **10 MIN** fourteen times.

Press **1 MIN** three times.

Press **10 SEC** three times.

If the key (10 MIN / 1 MIN / 10 SEC) is pressed and held, the time will increase rapidly.



Press **CLOCK** to set the time.

The clock starts counting.



Child Lock



Your oven has a safety feature that prevents accidental running of the oven. Once the child lock is set, you will be unable to use any functions and no cooking can take place. However your child can still open the oven door.



Press and hold **STOP/ CLEAR** until “L” appears on the display and BEEP sounds.

The **CHILD LOCK** is now set.

The time will disappear on the display but will reappear on the display a few seconds later.



If any function is pressed, “L” will appear on the display



To cancel **CHILD LOCK** press and hold **STOP/ CLEAR** until “L” disappears. You will hear BEEP when it's released.



Micro Power Cooking

In the following example I will show you how to cook some food on 80% power for 5 minutes and 30 seconds.



Your oven has five microwave Power settings. High power is automatically selected but repeated presses of the **MICRO** key will select a different power level.

POWER	Press MICRO	%
HIGH	1 time	100%
MEDIUM HIGH	2 times	80%
MEDIUM	3 times	60%
DEFROST MEDIUM LOW	4 times	40%
LOW	5 times	20%

Make sure you have correctly installed your oven as described earlier in this book.

Press **STOP/ CLEAR**.



Press **MICRO** twice to select 80% power. "80" appears on the display.



Press **1** time.
Press **10 SEL** times.

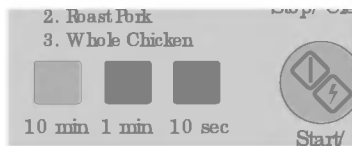

Press



Micro Power Level

Your microwave oven is equipped with 5 power levels to give you maximum flexibility and control over cooking. The table below shows the examples of food and their recommended cooking power levels for use with this microwave oven.

HIGH	100%	<ul style="list-style-type: none">* Boil Water* Brown minced beef* Cook poultry pieces, fish, vegetables* Cook tender cuts of meat
MEDIUM HIGH	80%	<ul style="list-style-type: none">* All reheating* Roast meat and poultry* Cook mushrooms and shellfish* Cook foods containing cheese and eggs
MEDIUM	60%	<ul style="list-style-type: none">* Bake cakes and scones* Prepare eggs* Cook custard* Prepare rice, soup
DEFROST/ MEDIUM LOW	40%	<ul style="list-style-type: none">* All thawing* Melt butter and chocolate* Cook less tender cuts of meat
LOW	20%	<ul style="list-style-type: none">* Soften butter & cheese* Soften ice cream* Raise yeast dough



Two stage Cooking

In the following example I will show you how to cook some food in two stages. The first stage will cook your food for 11 minutes on HIGH; the second will cook for 35 minutes on 40%.



During two stage cooking the oven door can be opened and food checked. Close the oven door and press **START** and the cooking stage will continue.

At the end of stage1, BEEP sounds and stage 2 commences.

Should you wish to clear the programme press **STOP/ CLEAR** twice.

Press **STOP/ CLEAR**



Set the number and the cooking time for **stage1**.



Press **MIN** to select HIGH power.



Press **10 MIN** once.

Press **1 MIN** once.

Set the number and the cooking time for **stage2**.



Press **MIN** four times to select 40% power.



Press **10 MIN** three times.

Press **1 MIN** five times.



Quick Start

In the following example I will show you how to set 2 minutes of cooking on high power.



The **QUICK START** feature allows you to set 30 seconds intervals of HIGH power cooking with a touch of the **START** key.



Press **START** four times to select 2 minutes on HIGH power.
Your oven will start before you have finished the fourth press.



During **QUICK START** cooking, you can extend the cooking time up to 10 minutes by repeatedly pressing the **START** key.



More or Less Cooking

In the following example I will show you how to change the preset AUTO COOK programmes for a longer or shorter cooking time.



If you find that your food is over or undercooked when using the AUTO COOK programme, you can increase or decrease cooking time by pressing the MORE/ LESS key.

When cooking with auto and manual function, you can lengthen or shorten the cooking time at any point by pressing the MORE/ LESS key.

There is no need to stop the cooking process.

Press **START/HEAT**.



Set the required **AUTO COOK** programme.



Select weight of food.



Press **START**.



Press **MORE**.
The cooking time will increase by **10** seconds for each press of the key.

Press **LESS**.

The cooking time will decrease by **10** seconds for each press of the key.



Grill Cooking

In the following example I will show you how to use the grill to cook some food for 12 minutes and 30 seconds.



This model is fitted with a **QUARTZ GRILL**, so preheating is not needed.

This feature will allow you to brown and crisp food quickly.

The metal tray is placed between a glass tray and a grill rack at the grill mode.

The grill rack (high rack) must be used during grill cooking.

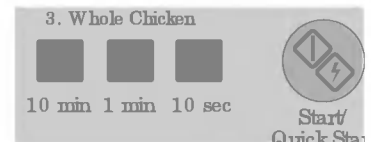
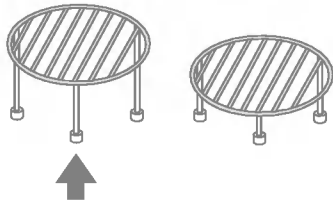

Convection Cooking

In the following example I will show you how to preheat the oven first, then cook some food at a temperature of 230 °C for 50 minutes.



The convection oven has a temperature range of 40 °C and 100 °C~250 °C (180 °C is automatically available when convection mode is selected).

The oven has a ferment function at the oven temperature of 40 °C. You may wait until the oven is cool because you can not use a ferment function if the oven temperature is over 40 °C.

Your oven will take a few minutes to reach the selected temperature.

Once it has reached correct temperature, your oven will BEEP to let you know that it has reached the correct temperature. Then place your food in your oven: then tell your oven to start cooking.

1. To preheat
Press **STOP/ CLEAR**



Press **STOP/ CLEAR**



Press **MORE** five times to select 230 °C.
The cooking temperature can be changed by pressing MORE/ LESS key.



Press **STOP/ CLEAR**



Convection Cooking



If you do not set a temperature, your oven will automatically select 180 °C. The cooking temperature can be changed by pressing the MORE/ LESS key.

The convection rack(low rack) must be used during convection cooking.

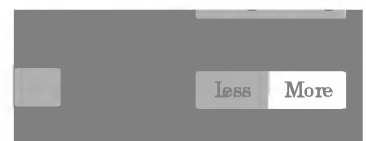
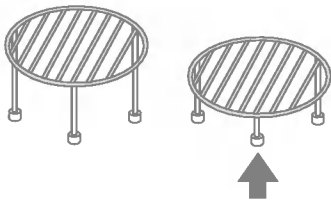

Combination Cooking



Your oven has a combination cooking feature which allows you to cook food with **heater** and **microwave** at the same time. This generally means it takes less time to cook your food.

You can set three kinds of micro power level(20% ,40%and 60%) in combi mode.

In the following example I will show you how to programme your oven with - micro power 40%and grill for a cooking time of 25 minutes.

1. GRILL COMBINATION.

Press **STOP/REAR**.



Press



Press



to select 40% power.



Set the cooking time.

Press **10** **MIN** 10 times.

Press **1** **MIN** 5 times.



Press **START**.

When cooking you can use **MORE/ LESS** key to increase or decrease cooking time.



Be careful when removing your food because the container will be hot!

Combination Cooking

In the following example I will show you how to programme your oven with micro power 40% and at a convection temperature 200 °C for a cooking time of 25 minutes.



Your oven has a combination cooking feature which allows you to cook food with **heater** and **microwave** at the same time. This generally means it takes less time to cook your food.

2. CONVECTION COMBINATION.

Press **STOP CLEAR**.



Press **COMBI**.

Press **COMBI**.

Press **MORE** two times for convection temperature 200 °C.



Press **MORE** two times to select 40% power.



Set the cooking time.

Press **10 MIN** two times.

Press **1 MIN** two times.



Press **START**.

When cooking you can use **MORE/ LESS** key to increase or decrease cooking time.



Be careful when removing your food because the container will be hot!

Auto Defrost



Your oven has four microwave defrost settings:- **MEAT**, **POULTRY**, **FISH** and **BREAD**; each defrost category has different power settings. Repeated presses of the **AUTO DEFROST** key will select a different setting.

Category	Press	
	DEFROST 1,2	
MEAT	1	time
POULTRY	2	times
	DEFROST 3,4	
FISH	1	time
BREAD	2	times

The temperature and density of food varies, I would recommend that the food is checked before cooking commences. Pay particular attention to large joints of meat and chicken, some foods should not be completely thawed before cooking. For example fish cooks so quickly that it is sometimes better to begin cooking while still slightly frozen. The **BREAD** programme is suitable for defrosting small items such as rolls or a small loaf. These will require a standing time to allow the centre to thaw. In the following example I will show you how to defrost 1.4Kg of frozen poultry.

Press **STOP/ CLEAR**.

Weigh the food that you are about to defrost. Be certain to remove any metallic ties or wraps; then place the food in your oven and close the oven door.



Press **DEFROST** twice to select the **POULTRY** defrosting programme. "dEF2" appears on the display window.



Enter the weight of the frozen food that you are about to defrost.

Press **1.0** weight key one time.
Press **0.1 kg** of weight key four times.







Press



During defrosting your oven will "BEEP", at which point open the oven door, turn food over and separate to ensure even thawing. Remove any portions that have thawed or shield them to help slow down thawing. After checking close the oven door and press **START** to resume defrosting.

Your oven will not stop defrosting (even when the beep sounded) unless the door is opened.

AUTO WEIGHT DEFROST SEQUENCE LIST

SEQUENCE		FOOD	MIN./ MAX. FOOD
1. MEAT 	Beef	Minced beef, Fillet steak, Cubes for stew, Sirloin steak, Pot roast, Flump roast, Beef burger.	0.1/ 4.0 kg
	Pork	Chops(2.5 cm thick), Rolled roast.	
	Veal	Cutlets(450 g, 1.2 cm thick)	
2. POULTRY 	Chicken	Whole(under 2 Kg), Cut up Breasts(boneless), Legs.	0.1/ 4.0 kg
	Turkey	Breasts(under 2.5 Kg)	
3. FISH 	Fish	Fillets, Steaks, Whole	0.1/ 4.0 kg
	Shellfish	Crabmeat, Lobster tails, Shrimp, Scallops	
4. BREAD 		Sliced brown/ white bread, White/ brown rolls, French stick, Baguette, Croissant	0.1/ 0.5 kg

- * The benefit of this Auto Defrost feature is automatic setting and control of defrosting, but just like conventional defrosting you must check the food during the defrosting time.
- * For best results, remove fish, shellfish, meat and poultry from its original paper or plastic package(wrapper). Otherwise, the wrap will hold steam and juice close to the food which can cause the outer surface of the food to cook.
- * Place foods in a shallow glass baking dish to catch drippings.
- * Food should still be some what icy in the centre when removed from the oven.
- * When it is difficult to remove the wrap from the food, defrost the wrapped food for about a quarter of the total defrost time, which is displayed at the beginning of the defrost cycle. Then remove the food from the oven and remove the wrap from the food.
- * Sliced bread should be placed between sheets of kitchen towel and bread rolls should be cut in half before defrosting.



Auto Cook

In the following example I will show you how to cook 0.6kg of jacket potato .



AUTO COOK allows you to cook most of your favorite food easily by selecting the food type and entering the weight of the food by pressing the **1.0kg** or **0.1kg** key.



Press **AUTO COOK** of the required food type. In this example, press **JACKET POTATO** once.

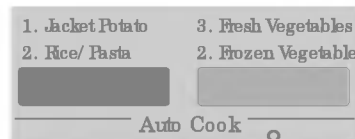

Select the weight of potato. Press **0.1kg** weight key five times.



If the **1.0kg** or **0.1kg** key is pressed and held, the weight will increase rapidly.

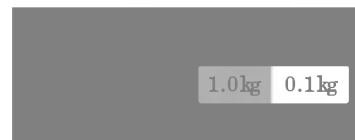

1. JACKET POTATO	0.2 kg ~ 1.0 kg	Glass tray + Paper towel	20 °c	Wash and dry potatoes. Pierce potatoes several times with fork. After cooking, let stand covered with foil for 5 min.															
2 .RICE/ PASTA	0.1 kg ~ 0.3 kg	Glass tray	20 °c	Place rice & water with ¼ to 1 teaspoon salt in a deep and large bowl. Cover with lid or plastic wrap. ** Rice -- After cooking time, stir rice and let stand for 5 to 10 min. covered. ** Pasta -- After cooking time, rinse pasta with cold water.															
		Glass tray	20 °c	<table border="1"> <thead> <tr> <th>* Amount (Rice / Pasta)</th> <th>Water (Rice)</th> <th>(Pasta)</th> </tr> </thead> <tbody> <tr> <td>½ cup (100g / 50g)</td> <td>— 1 cup</td> <td>— 1½ cups</td> </tr> <tr> <td>1 cup (200g / 100g)</td> <td>— 2 cups</td> <td>— 2½ cups</td> </tr> <tr> <td>1½ cups (300g / 150g)</td> <td>— 3 cups</td> <td>— 3½ cups</td> </tr> <tr> <td>2 cup (400g / 200g)</td> <td>— 4 cups</td> <td>— 4½ cups</td> </tr> </tbody> </table>	* Amount (Rice / Pasta)	Water (Rice)	(Pasta)	½ cup (100g / 50g)	— 1 cup	— 1½ cups	1 cup (200g / 100g)	— 2 cups	— 2½ cups	1½ cups (300g / 150g)	— 3 cups	— 3½ cups	2 cup (400g / 200g)	— 4 cups	— 4½ cups
* Amount (Rice / Pasta)	Water (Rice)	(Pasta)																	
½ cup (100g / 50g)	— 1 cup	— 1½ cups																	
1 cup (200g / 100g)	— 2 cups	— 2½ cups																	
1½ cups (300g / 150g)	— 3 cups	— 3½ cups																	
2 cup (400g / 200g)	— 4 cups	— 4½ cups																	
3. FRESH VEGETABLES	0.2 kg ~ 0.8 kg			Place in a microwave-safe bowl or casserole. Add 30cc water per 0.2kg. Cover with plastic wrap. After cooking time, let stand covered for 2~3 min.															
4. FROZEN VEGETABLES	0.2 kg ~ 0.8 kg			Place in a microwave-safe bowl or casserole. Cover with plastic wrap. Let stand for 2~3 min.															

Auto Roast

Cook

In the following example I will show you how to cook 1.4kg of roast beef.



AUTO ROAST cook allows you to cook most of your favorite food easily by selecting the food type and entering the weight of the food.

Category	Press	
ROAST BEEF	1	time
ROAST PORK	2	times
WHOLE CHICKEN	3	times



Press **AUTO ROAST** once to select **ROAST BEEF**.



Select the weight of roast beef.
Press **1.0kg** weight key one time.
Press **0.1kg** weight key four times.

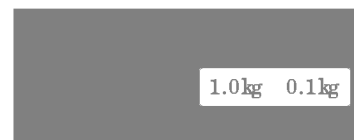

1. ROAST BEEF	0.5 kg ~ 1.5 kg	Glass tray + Metal tray + Convection rack	5 °C	Brush beef with melted margarine or butter. Place on the low rack over the metal tray and glass tray. After cooking, let stand covered with foil for 10 minutes.
2. ROAST PORK	0.5 kg ~ 1.5 kg	Glass tray + Metal tray + Convection rack	5 °C	Brush lamb with melted margarine or butter. Place on the low rack over the metal tray and glass tray. After cooking, let stand covered with foil for 10 minutes.
3. WHOLE CHICKEN	0.8 kg ~ 1.5 kg	Glass tray + Metal tray	5 °C	Brush whole chicken with melted margarine, butter or seasonings, if desired. Place the whole chicken on the metal tray on the glass tray. When BEEP, drain the juices and turn food over immediately. After cooking, let stand covered with foil 10 minutes.

Rotisserie

In the following example I will show you how to cook whole chicken.

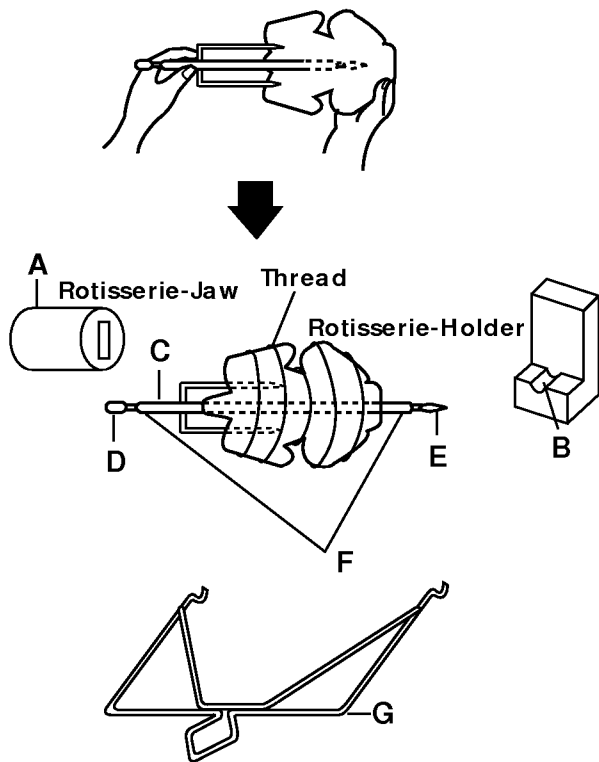

1. Position the fully defrosted chicken on the spit, ensuring that the rotisserie bar runs centrally through the chicken. And tie the chicken with thread to the bar, if necessary.

NOTE: IT IS VERY IMPORTANT TO FULLY DEFROST THE CHICKEN BEFORE COOKING, FAILURE TO DO SO MAY RESULT IN THE CHICKEN BEING UNDERCOOKED.

2. Insert the end of the rotisserie bar (D) into the rotisserie jaw (A) on the left side of the oven wall. Push it to the left, rotating the rotisserie bar slightly until the rotisserie-bar fits into the rotisserie jaw (A).
3. Support the other end of the rotisserie bar (E) on the hollow of the rotisserie holder (B).
4. Carefully place the heat proof glass ware in the microwave oven, on top of the glass turntable.
5. After closing the oven door, follow **AUTO ROAST** cook (page22).

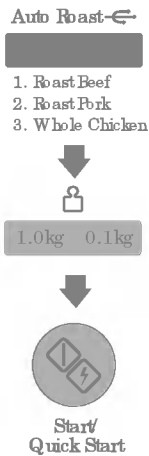
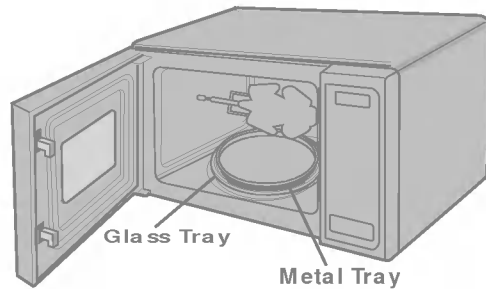

6. After cooking, hold the rotisserie bar at both side (F) with the handle (G) and lift up the right end slightly, and pull out from the right end.

NOTE

1. The rotisserie cooking is convenient for grilling of meat and poultry. All the surface of the food will become even brown without overturning.
2. The rotisserie cooking can used in microwave mode, combination mode, grill mode, auto roast and auto cook.
3. The rotisserie bar is for rotisserie cooking only. After rotisserie cooking is finished remove the rotisserie bar and store with other accessories.

CAUTION

1. **AFTER COOKING, THE METAL TRAY WILL BECOME EXTREMELY HOT.**
2. It is recommended to remove the grease from the turntable every time before cooking. Hot grease on the turntable may cause smoke.

Safety

Precautions

WARNING

Please ensure cooking times are correctly set as over cooking may result in FIRE and subsequent DAMAGE to the OVEN.

- 1 Do not attempt to tamper with, or make any adjustments or repairs to the door, control panel, safety interlock switches or any other part of the oven. It is hazardous for anyone to carry out any service or repair operation which involves the removal of any cover which gives protection against exposure to microwave energy. Repairs should only be undertaken by a qualified service technician.
- 2 Do not operate the oven when empty. It is best to leave a glass of water in the oven when not in use. The water will safely absorb all microwave energy, if the oven is accidentally started.
- 3 Do not dry clothes in the microwave oven, which may become carbonized or burned if heated too long.
- 4 Do not cook food wrapped in paper towels, unless your cook book contains instructions, for the food you are cooking.
- 5 Do not use newspaper in place of paper towels for cooking.
- 6 Do not use wooden containers. They may heat-up and char. Do not use ceramic containers which have metallic (e.g. gold or silver) inlays. Always remove metal twist ties. Metal objects in the oven may arc, which can cause serious damage.
- 7 Do not operate the oven with a kitchen towel, a napkin or any other obstruction between the door and the front edges of the oven, which may cause microwave energy leakage.
- 8 Do not use recycled paper products since they may contain impurities which may cause sparks and/ or fires when used in cooking.
- 9 Do not rinse the turntable by placing it in water just after cooking. This may cause breakage or damage.
- 10 Small amounts of food require shorter cooking or heating time. If normal times are allowed they may overheat and burn.
- 11 Be certain to place the oven so the front of the door is 8 cm or more behind the edge of the surface on which it is placed, to avoid accidental tipping of the appliance.
- 12 Before cooking, pierce the skin of potatoes, apples or any such fruit or vegetable.
- 13 Do not cook eggs in their shell. Pressure will build up inside the egg which will burst.
- 14 Do not attempt deep fat frying in your oven.
- 15 Remove the plastic wrapping from food before cooking or defrosting. Note though that in some cases food should be covered with plastic film, for heating or cooking.
- 16 If the oven door or door seals are damaged, the oven must not be operated until it has been repaired by a qualified service technician.
- 17 If smoke is observed, switch off or disconnect the oven from the power supply and keep the oven door closed in order to stifle any flames.
- 18 When food is heated or cooked in disposable containers of plastic, paper or other combustible materials, check the oven frequently due to the possibility of ignition.
- 19 Only allow children to use the oven without supervision when adequate instructions have been given so that the child is able to use the oven in a safe way and understands the hazards of improper use.
- 20 Liquids or other foods must not be heated in sealed containers since they are liable to explode.

Microwave-safe Utensils

Never use metal or metal trimmed utensils in your microwave oven

Microwaves cannot penetrate metal. They will bounce off any metal object in the oven and cause arcing, an alarming phenomenon that resembles lightning.

Most heat resistant non metallic cooking utensils are safe for use in your microwave oven. However, some may contain materials that render them unsuitable as microwave cookware. If you have any doubts about a particular utensil, there's a simple way to find out if it can be used in your microwave oven.

Place the utensil in question next to a glass bowl filled with water in the microwave oven. Microwave at power HIGH for 1 minute. If the water heats up but the utensil remains cool to the touch, the utensil is microwave-safe. However, if the water does not change temperature but the utensil becomes warm, microwaves are being absorbed by the utensil and it is not safe for use in the microwave oven. You probably have many items on hand in your kitchen right now that can be used as cooking equipment in your microwave oven. Just read through the following checklist.

Dinner plates

Many kinds of dinner-ware are microwave-safe. If in doubt consult the manufacturer's literature or perform the microwave test.

Glassware

Glassware that is heat-resistant is microwave-safe. This would include all brands of oven tempered glass cookware. However, do not use delicate glassware, such as tumblers or wine glasses, as these might shatter as the food warms.

Plastic storage containers

These can be used to hold foods that are to be quickly reheated. However, they should not be used to hold foods that will need considerable time in the oven as hot foods will eventually warp or melt plastic containers.

Paper

Paper plates and containers are convenient and safe to use in your microwave oven, provided that the cooking time is short and foods to be cooked are low in fat and moisture. Paper towels are also very useful for wrapping foods and for lining baking trays in which greasy foods such as bacon are cooked. In general, avoid coloured paper products as the colour may run. Some recycled paper products may contain impurities which could cause arcing or fires when used in the microwave oven.

Plastic cooking bags

Provided they are made specially for cooking, cooking bags are microwave safe. However, be sure to make a slit in the bag so that steam can escape. Never use ordinary plastic bags for cooking in your microwave oven, as they will melt and rupture.

Plastic microwave cookware

A variety of shapes and sizes of microwave cookware are available. For the most part, you can probably use items you already have on hand rather than investing in new kitchen equipment.

Pottery, stoneware and ceramic

Containers made of these materials are usually fine for use in your microwave oven, but they should be tested to be sure.

CAUTION

Some items with high lead or iron content are not suitable for cooking utensils.

Utensils should be checked to ensure that they are suitable for use in microwave ovens.

Food characteristics & Microwave cooking

Keeping an eye on things

The recipes in the book have been formulated with great care, but your success in preparing them depends on how much attention you pay to the food as it cooks. Always watch your food while it cooks. Your microwave oven is equipped with a light that turns on automatically when the oven is in operation so that you can see inside and check the progress of your food. Directions given in recipes to elevate, stir, and the like should be thought of as the minimum steps recommended. If the food seems to be cooking unevenly, simply make the necessary adjustments you think appropriate to correct the problem.

Factors affecting microwave cooking times

Many factors affect cooking times. The temperature of ingredients used in a recipe makes a big difference in cooking times. For example, a cake made with ice-cold butter, milk, and eggs will take considerably longer to bake than one made with ingredients that are at room temperature. All of the recipes in this book give a range of cooking times. In general, you will find that the food remains under-cooked at the lower end of the time range, and you may sometimes want to cook your food beyond the maximum time given, according to personal preference. The governing philosophy of this book is that it is best for a recipe to be conservative in giving cooking times. While overcooked food is ruined for good. Some of the recipes, particularly those for bread, cake, and custards, recommend that food be removed from the oven when they are slightly undercooked. This is not a mistake. When allowed to stand, usually covered, these foods will continue to cook outside of the oven as the heat trapped within the outer portions of the food gradually travels inward. If the food is left in the oven until it is cooked all the way through, the outer portions will become overcooked or even burnt. You will become increasingly skilful in estimating both cooking and standing times for various foods.

Density of food

Light, porous food such as cakes and breads cook more quickly than heavy, dense foods such as roasts and casseroles. You must take care when microwaving porous food that the outer edges do not become dry and brittle.

Height of food

The upper portion of tall food, particularly roasts, will cook more quickly than the lower portion. Therefore, it is wise to turn tall food during cooking, sometimes several times.

Moisture content of food

Since the heat generated from microwaves tends to evaporate moisture, relatively dry food such as roasts and some vegetables should either be sprinkled with water prior to cooking or covered to retain moisture.

Bone and fat content of food

Bones conduct heat and fat cooks more quickly than meat. Care must be taken when cooking bony or fatty cuts of meat that they do not cook unevenly and do not become overcooked.

Quantity of food

The number of microwaves in your oven remains constant regardless of how much food is being cooked. Therefore, the more food you place in the oven, the longer the cooking time. Remember to decrease cooking times by at least one third when halving a recipe.

Shape of food

Microwaves penetrate only about 2 cm into food, the interior portion of thick foods are cooked as the heat generated on the outside travels inward. Only the outer edge of food is cooked by microwave energy; the rest is cooked by conduction. The worst possible shape for a food that is to be microwaved is a thick square. The corners will burn long before the centre is even warm. Round thin foods and ring shaped foods cook successfully in the microwave.

Covering

A cover traps heat and steam which causes food to cook more quickly. Use a lid or microwave cling film with a corner folded back to prevent spitting.

Browning

Meats and poultry that are cooked fifteen minutes or longer will brown lightly in their own fat. Food that are cooked for a shorter period of time may be brushed with a browning sauce such as Worcestershire sauce, soy sauce or barbecue sauce to achieve an appetizing colour. Since relatively small amounts of browning sauces are added to food the original flavour of the recipe is not altered.

Covering with greaseproof paper

Greaseproofing effectively prevents spattering and helps food retain some heat. But because it makes a looser cover than a lid or clingfilm, it allows the food to dry out slightly.

Arranging and spacing

Individual foods such as baked potatoes, small cakes and hors d'oeuvres will heat more evenly if placed in the oven an equal distance apart, preferably in a circular pattern. Never stack foods on top of one another.

Food characteristics & Microwave cooking.

Stirring

Stirring is one of the most important of all microwaving techniques. In conventional cooking, food is stirred for the purpose of blending. Microwaved food, however, is stirred in order to spread and redistribute heat. Always stir from the outside towards the centre as the outside of the food heats first.

Turning over

Large, tall foods such as roasts and whole chickens should be turned so that the top and bottom will cook evenly. It is also a good idea to turn cut up chicken and chops.

Placing thicker portions facing outwards

Since microwaves are attracted to the outside portion of food, it makes sense to place thicker portions of meat, poultry and fish to the outer edge of the baking dish. This way, thicker portions will receive the most microwave energy and the food will cook evenly.

Shielding

Strips of aluminium foil (which block microwaves) can be placed over the corners or edges of square and rectangular foods to prevent those portions from overcooking. Never use too much foil and make sure the foil is secured to the dish or it may cause 'arcing' in the oven.

Elevating

Thick or dense foods can be elevated so that microwaves can be absorbed by the underside and centre of the foods.

Piercing

Foods enclosed in a shell, skin or membrane are likely to burst in the oven unless they are pierced prior to cooking. Such foods include yolks and whites of eggs, clams and oysters and whole vegetables and fruits.

Testing if cooked

Food cooks so quickly in a microwave oven, it is necessary to test it frequently. Some foods are left in the microwave until completely cooked, but most foods, including meats and poultry, are removed from the oven while still slightly undercooked and allowed to finish cooking during standing time. The internal temperature of foods will rise between 5°F (3°C) and 15°F (8°C) during standing time.

Standing time

Foods are often allowed to stand for 3 to 10 minutes after being removed from the microwave oven. Usually the foods are covered during standing time to retain heat unless they are supposed to be dry in texture (some cakes and biscuits, for example). Standing allows foods to finish cooking and also helps flavour blend and develop.

To Clean Your Oven

1 Keep the inside of the oven clean

Food spatters or spilled liquids stick to oven walls and between seal and door surface. It is best to wipe up spillovers with a damp cloth right away. Crumbs and spillovers will absorb microwave energy and lengthen cooking times. Use a damp cloth to wipe out crumbs that fall between the door and the frame. It is important to keep this area clean to assure a tight seal. Remove greasy spatters with a soapy cloth then rinse and dry. Do not use harsh detergent or abrasive cleaners. The glass tray can be washed by hand or in the dishwasher.

2 Keep the outside of the oven clean

Clean the outside of your oven with soap and water then with clean water and dry with a soft cloth or paper towel. To prevent damage to the operating parts inside the oven, the water should not be allowed to seep into the ventilation openings. To clean control panel, open the door to prevent oven from accidentally starting, and wipe a damp cloth followed immediately by a dry cloth. Press STOP/ CLEAR after cleaning.

3 If steam accumulates inside or around the outside of the oven door, wipe the panels with a soft cloth. This may occur when the microwave oven is operated under high humidity conditions and in no way indicates a malfunction of the unit.

4 The door and door seals should be kept clean. Use only warm, soapy water, rinse then dry thoroughly.

DO NOT USE ABRASIVE MATERIALS, SUCH AS CLEANING POWDERS OR STEEL AND PLASTIC PADS.

Metal parts will be easier to maintain if wiped frequently with a damp cloth.

Questions & Answers

Q What's wrong when the oven light will not glow?

- A There may be several reasons why the oven light will not glow.
Light bulb has blown
Door is not closed

Q Does microwave energy pass through the viewing screen in the door?

- A No. The holes, or ports, are made to allow light to pass; they do not let microwave energy through.

Q Why does the beep tone sound when a pad on the Control Panel is touched?

- A The beep tone sounds to assure that the setting is being properly entered.

Q Will the microwave oven be damaged if it operates empty?

- A Yes Never run it empty or without the glass tray.

Q Why do eggs sometimes pop?

- A When baking, frying, or poaching eggs, the yolk may pop due to steam build up inside the yolk membrane. To prevent this, simply pierce the yolk before cooking. Never microwave eggs in the shell.

Q Why is standing time recommended after microwave cooking is over?

- A After microwave cooking is finished, food keeps on cooking during standing time. This standing time finishes cooking evenly throughout the food. The amount of standing time depends on the density of the food.

Q Is it possible to pop corn in a microwave oven?

- A Yes, if using one of the two methods described below
- 1 Popcorn-popping utensils designed specifically for microwave cooking.
 - 2 Prepackaged commercial microwave popcorn that contains specific times and power outputs needed for an acceptable final product.

FOLLOW EXACT DIRECTIONS GIVEN BY EACH MANUFACTURER FOR THEIR POPCORN PRODUCT. DO NOT LEAVE THE OVEN UNATTENDED WHILE THE CORN IS BEING POPPED. IF CORN FAILS TO POP AFTER THE SUGGESTED TIMES, DISCONTINUE COOKING. OVERCOOKING COULD RESULT IN THE CORN CATCHING FIRE.

CAUTION

NEVER USE A BROWN PAPER BAG FOR POPPING CORN. NEVER ATTEMPT TO POP LEFTOVER KERNELS.

Q Why doesn't my oven always cook as fast as the cooking guide says?

- A Check your cooking guide again to make sure you've followed directions correctly, and to see what might cause variations in cooking time. Cooking guide times and heat settings are suggestions, chosen to help prevent overcooking, the most common problem in getting used to a microwave oven. Variations in the size, shape, weight and dimensions of the food require longer cooking time. Use your own judgement along with the cooking guide suggestions to test food condition, just as you would do with a conventional cooker.

Plug wiring information/ Technical Specifications

Warning

The wires in this mains lead are colored in accordance with the following codes
 BLUE ~ Neutral
 BROWN ~ Live
 GREEN & YELLOW ~ Earth

As the colours of the wires in the mains lead of this appliance may not correspond with the coloured markings identifying the terminals in your plug proceed as follows:

The wire which is colored BLUE must be connected to the terminal which is marked with the letter N or Colored BLACK.

The wire which is colored BROWN must be connected to the terminal which is marked with the letter L or colored RED.

The wire which is colored GREEN & YELLOW or GREEN must be connected to the terminal which is marked with the letter E or .

If the supply cord is damaged, it must be replaced by the manufacturer or its service agent or a similarly qualified person in order to avoid a hazard;

Technical Specification

	MC-805CLR	
Power Input	230 V AC / 50Hz	240 V AC / 50Hz
Output	850 W (IEC705 rating standard)	
Microwave Frequency	2450 MHz	
Outside Dimension	530 mm(W) X 322 mm(H) X 500 mm(D)	
Power Consumption		
Microwave	1350 Watts	1350 Watts
Grill	1250 Watts	1350 Watts
Combination	2650 Watts	2750 Watts
Convection	1350 Watts(Max 2550 Watts)	1450 Watts(Max 2750 Watts)



P/ No: 3828W5A1406

Printed in Korea