



Color Television OWNER'S MANUAL

MODEL : PP-43/48/53A80P

Please read this manual carefully before operating your set.
Retain it for future reference.
Record model number and serial number of the set.
See the label attached on the back cover and quote this
information to your dealer when you require service.

Internet Home Page www.lge.com

Safety Precautions

WARNING : TO REDUCE THE RISK OF FIRE OR ELECTRIC SHOCK, DO NOT EXPOSE THIS PRODUCT TO RAIN OR MOISTURE.
CAUTION : TO REDUCE THE RISK OF ELECTRIC SHOCK, DO NOT REMOVE COVER(OR BACK). NO USER-SERVICEABLE PARTS IN SIDE. REFER SERVICING TO QUALIFIED SERVICE PERSONNEL.

Cleaning

Unplug this television receiver from the wall outlet before cleaning. Do not use liquid cleaners or aerosol cleaners. Use a damp cloth for cleaning.
Do not use attachments not recommended by the television receiver manufacturer as they may cause hazards.

Power Supply

This television receiver should be operated only from the type of power source indicated on the marking label. If you are not sure of the type of power supplied to your home, consult your television dealer or local power company.

Installation

Do not use this television receiver near water, for example, near a bathtub, washbowl, kitchen sink, or laundry tub, in a wet basement, or near a swim-ming pool, etc.
Do not place this television on a sloping or unstable area as the casters on the bottom of the television may cause it to move and to be damaged.
Slots and openings in the cabinet and the back or bottom are provided for ventilation, and to insure reliable operation of the television receiver, and to protect it from overheating. These openings must not be blocked or

covered. The openings should never be blocked by placing the television receiver on a bed, sofa, rug, or other similar surface. This television receiver should not be placed in a built-in installation such as a bookcase unless proper ventilation is provided.
It is recommended not to operate this unit near speakers or big metallic furnitures in order to keep their magnetism from disturbing colors purity (uniformity) on the screen.

Use

Do not allow anything to rest on the power cord. Do not locate this television receiver where the cord will be abused by persons walking on it. Do not overload wall outlets and extension cords as this can result in fire or electric shock. Never push objects of any kind into this television receiver through cabinet slots as they may touch dangerous voltage points or short out parts that could result in a fire or electric shock. Never spill liquid of any kind on the television receiver.

Service

Do not attempt to service this television yourself as opening or removing covers may expose you to dangerous voltage or other hazards. Refer all servicing to qualified personnel.

Writing Model And Serial Numbers

The serial number and model number are found on the back of this unit. The serial number is unique to this unit. You should record requested information here and retain this guide as a permanent record of your purchase. Please retain your purchase receipt as your proof of purchase.

Date of Purchase
Dealer Purchased from
Dealer Address
Dealer Phone No.
Model No.
Serial No.

CONTENTS

Description of controls	4 ~ 6
Connecting Speakers (PP-48/53A80P only)	7
Basic TV operation	8 ~ 10
Turning on/off the TV	8
Selecting the on screen language	8
Memorizing Channels	9
Memorizing the Channels by AUTO PROGRAM	9
Memorizing the Channels by MANUAL PROGRAM	10
Selecting the Channel / Adjusting the Volume	10
Various function	11 ~ 13
Setting the Clock	11
Setting the OFF TIMER	11
Setting the ON TIMER	11
Setting the Sleep Time	12
Auto Off / Key Lock.....	12
Auto Demonstration / Adjusting the Fine Tuning	13
Favorite channel memory	13
Picture control	14 ~ 15
Enjoying the Eye Function	14
Auto Picture Control / Adjusting the Picture	14
DRP(Digital Reality Picture)	15
CONVERGENCE / DRP-DEMO	15
Sound control	16 ~ 19
Enjoying the Stereo/SAP Broadcast	16
AVL (Auto Volume Leveler)	16
Auto Sound Control	17 ~ 18
Adjusting the equalizer	19
Adjusting the balance	19
PIP function	20 ~ 21
Watching the PIP (Picture in Picture)	20
Selecting the input signal (in PIP mode).....	20
Moving the Sub Picture (in PIP mode)	21
Still Picture / Channel Search.....	21
Swapping Screens.....	21
Closed caption function	22 ~ 23
Using Closed Captions	22
Operating the Caption and Text	23
Antenna Connections	24
Connecting an Outdoor Antenna	24
Connecting a CATV Cable	24
Connection of external equipment	25 ~ 26
Connecting AUDIO/VIDEO IN Jacks	25
Connecting the S-VHS VCR	26
Recording Onto VCR	26
Recording a program from connected other equipment	26
Connecting DVD Player	27
Connecting PC as monitor	28 ~ 30
Troubleshooting check list	31

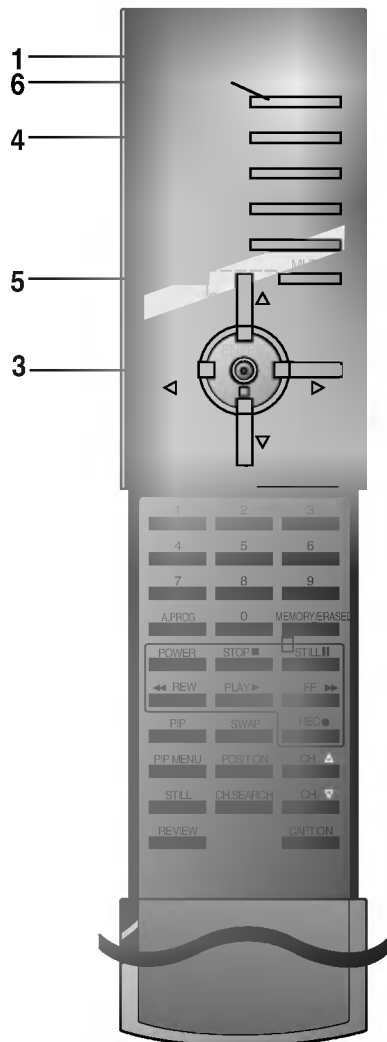
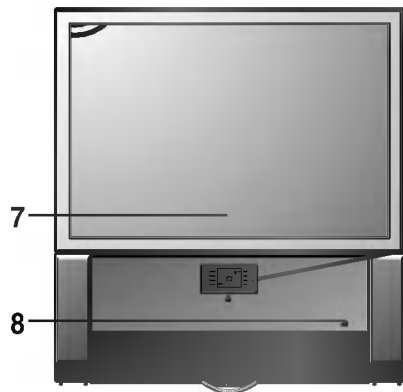

1. POWER BUTTON (or ON/OFF)

Refer to "Turning on/off the TV".

2. POWER/STAND BY INDICATOR

- Illuminates brightly when the TV is in standby mode.
- Dims when the TV is switched on.

3. CHANNEL UP/DOWN (▲ / ▼) BUTTONS

- To select the desired channel.
- To select the desired menu item when menu is displayed on the screen.

VOLUME UP/DOWN (◀ / ▶) BUTTONS

- To increase or decrease volume level.
- To enter or adjust the selected menu when menu is displayed on the screen.

ENTER (■) BUTTON

- To exit from the displayed menu.
- To memorize the adjusted menu.
- To recall the current TV mode (by remote control only).

4. DIGITAL INDEX BUTTON

To display information which is input to the TV with three different brightness.

5. MENU BUTTON

To display on screen menus one by one.

6. TV/VIDEO BUTTON

To select TV, VIDEO, COMPONENT or RGB-PC mode.

7. REMOTE CONTROL SENSOR

8. EYE SENSOR

Adjusts picture according to the surrounding conditions.

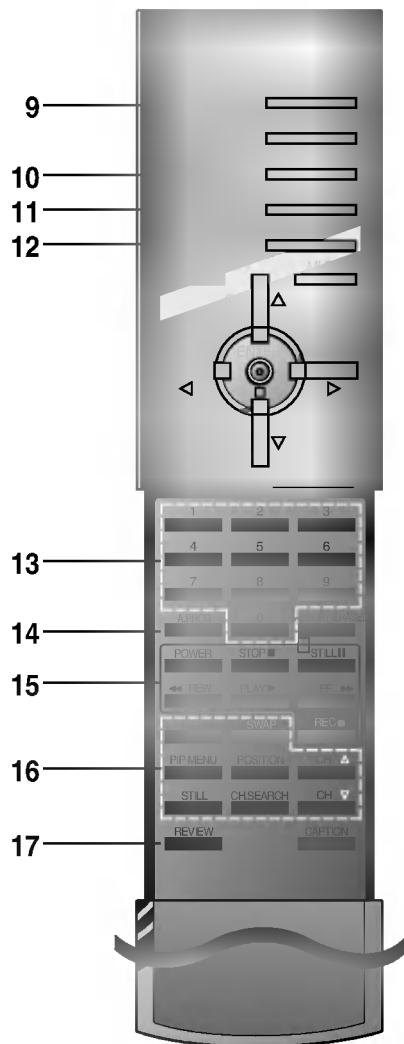

9. SLEEP BUTTON

To set the desired sleep time.

10. EYE BUTTON

To switch on or off eye picture.

Refer to "Enjoying the Eye Function".

11. APC (Auto Picture Control) BUTTON

To adjust the factory preset pictures corresponding to the lighting around.

12. FCR (Favorite Channel Review) BUTTON

To select the favorite channel.

Refer to "Favorite channel memory".

13. NUMBER BUTTONS

To select the desired channel directly.

14. A.PROG(Auto program) BUTTON

To memorize channels by AUTO PROGRAM.

15. VCR BUTTONS

To control LG video cassette recorder.

16. PIP (Picture in Picture) BUTTONS

PIP BUTTON

To select the PIP mode.

SWAP BUTTON

To exchange the main picture and sub picture.

PIP MENU BUTTON

To display various menu in the PIP mode

POSITION BUTTON

To move the sub picture to another corner of the main picture.

STILL BUTTON

To stand still the picture.(except COMPONENT 2 and RGB-PC mode)

CH. SEARCH BUTTON

To search one by one the pictures of all the programmed channels through the sub picture while the main picture remains as a current channel.

CH ▲/▼ BUTTONS

To select the desired channel of the sub picture.

17. REVIEW BUTTON

To return to the previous channel.



18. MULTIMEDIA BUTTON

To select COMPONENT or RGB-PC mode.

19. DASP BUTTON

To select the sound appropriate to your viewing program character ; **Pro Logic** (PP-48/53A80P only), **Virtual, CINEMA, MUSIC, SPORTS** or **USER**.

20. AVL (Auto Volume Leveler) BUTTON

To keep on equal volume level of each channels.

21. MTS BUTTON

To listen to the MTS sound ; **MONO, STEREO** or **SAP**.

22. MUTE BUTTON

To mute the sound. Again to restore the muted sound.

23. MEMORY/ERASE BUTTON

To memorize or erase the desired channel.

24. CAPTION BUTTON

To select the CAPTION mode.
Refer to "**Closed caption function**".

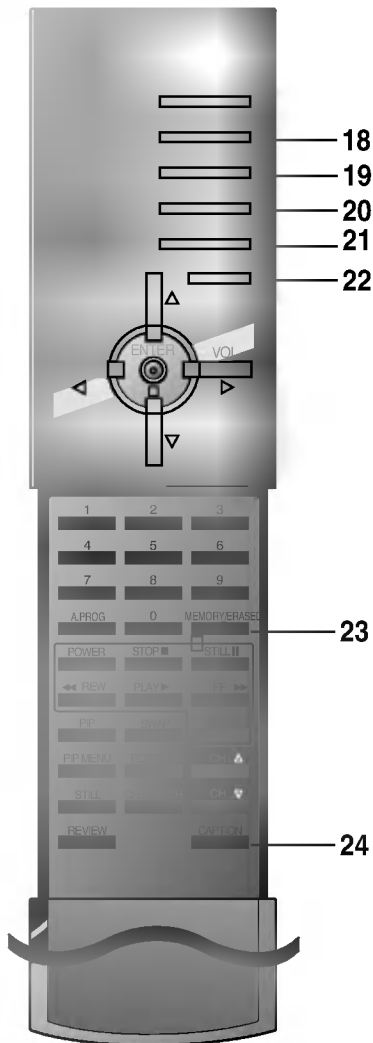

Fitting Batteries in the Remote Control Unit

The remote control is powered by batteries. This requires **AAA** type batteries for operation. To ensure consistent operation, change the batteries about once a year.

Caution: Batteries installed incorrectly may leak and damage the remote control. Do not mix old and new batteries or different types of batteries (for example, standard and alkaline).



1. Remove the battery compartment cover by sliding it in the arrowhead direction.



2. Insert new batteries as indicated by the polarity markings (+ and -) inside the compartment.

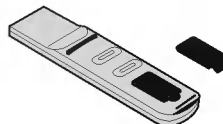

3. Replace the battery compartment cover.

1.How to connect

- Connect red (+) knob on the back of right speaker to red (R +) knob of MAIN SPEAKER on the back of TV
- Connect black (-) knob on the back of right speaker to black (R -) knob of MAIN SPEAKER on the back of TV
- Connect the left speaker in the same way how to connect the right speaker.

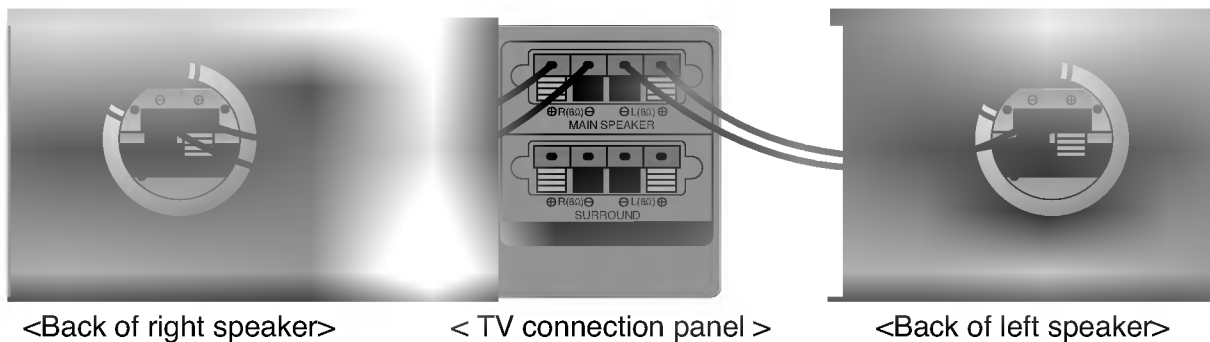

2.How to use

- Turn on the TV and then press the **MENU** button to select the **SOUND** menu.
- Adjust until getting the desired sound level in the **DASP** mode. Refer to pages 17 to 19.

- Notes:**
- Use the SURROUND knobs when connecting to other speakers which can output surround sound.
 - Left and right speakers are detachable, so you can place them wherever you want.
 - Before placing left and right speakers, screw the speaker legs to the holes on them.
 - When you connect other speakers to surround speaker knobs, other speakers are to be impedance 8 Ω and more than 25W(Max) output.

Before operating your TV, make sure the following instructions have been completed.

- Your TV has been connected to an antenna or a cable system.
- Your TV has been plugged in a power outlet.

Turning on/off the TV

1. Press the power button to turn on the TV.
2. If the TV is in standby mode, press any key on the remote control to turn on it fully.
3. Press the **POWER** button on the remote control.
The TV reverts to standby mode.
4. Press the power button again to turn off the TV.

Note: If, while the TV is turned on, the mains plug is disconnected the TV will switch to standby or power on when the mains plug is replaced in the mains power socket.

Selecting the on screen language

1. Press the **MENU** button until the menu is displayed as shown right.
2. Press the **▶** and then **▲/▼** button to select **LANGUAGE**.
3. Press the **▶** button to enter the language mode.
4. Press the **▲/▼** button to select the desired language.
From this point on, the on-screen display will be presented in the language of your choice.
5. Press the **ENTER (■)** button to exit.

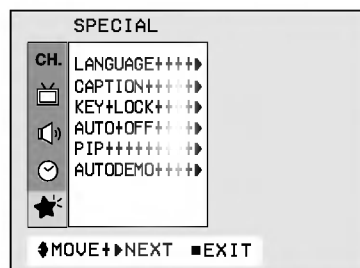

Memorizing Channels

This is the function to memorize all the active channels in your area before you can use the TV. There are two ways of memorizing channels. You can use either.

One is called **AUTO PROGRAM** and the other is called **MANUAL PROGRAM**.

In **AUTO PROGRAM** the TV will memorize the channels in ascending order. If there are additional channels you want to add or delete, you can manually add or delete those channels.

Memorizing the Channels by AUTO PROGRAM

AUTO PROGRAM searches and memorizes all the active channels in your area then you can select the desired channel with the ▲ / ▼ button.

Using the A.PROG button

You can conveniently perform AUTO PROGRAM using the **A.PROG** button on the remote control.

1. Press the **A.PROG** button.
2. Press the ▲/▼ button to select **TURBO** or **NORMAL**.
3. Press the ► or **A.PROG** button.

The AUTO PROGRAM starts now.

If you want to stop auto programming, press the **ENTER (■)** button. Only the channels searched up to that time are memorized.

TURBO AUTO PROGRAM is further faster than **NORMAL AUTO PROGRAM**.

Note : If the programmed signal has poor quality or the certain CH is not memorized, memorize again in the **NORMAL AUTO PROGRAM**.

Using the MENU button

1. Press the **MENU** button until the menu is displayed as shown right.
2. Press the ► and then ▲/▼ button to select **AUTO PROGRAM**.
3. Press the ► button to enter the **AUTO PROGRAM** mode.
4. Press the ▲/▼ button to select **TURBO** or **NORMAL**.
5. Press the ► button. The AUTO PROGRAM starts now.

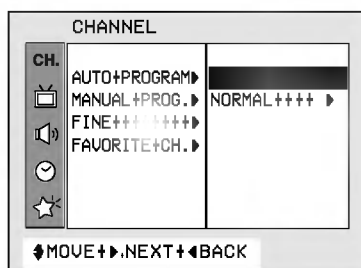
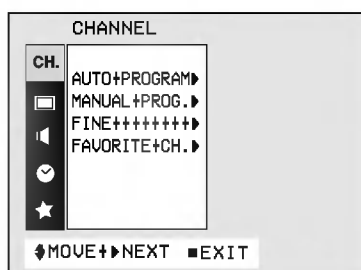
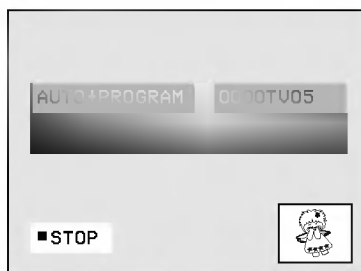
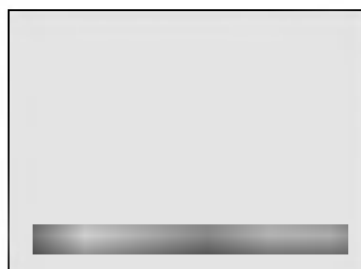

Memorizing the Channels by MANUAL PROGRAM

Using the MEMORY/ERASE button

You can conveniently perform MANUAL PROGRAM using the **MEMORY/ERASE** button on the remote control.

1. Press the **▲/▼** or **NUMBER** buttons to select the channel number you want to memorize or erase.
2. Press the **MEMORY/ERASE** button.
The on screen display appears as shown right.
3. Press the **VOL ◀/▶** or **MEMORY/ERASE** button to select **MEMORY** or **ERASE**.
4. Press the **ENTER (■)** button to exit.

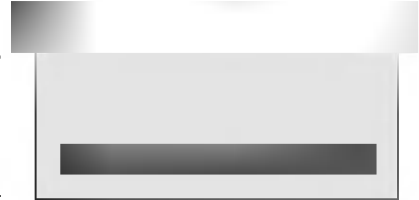

Using the MENU button

1. Press the **MENU** button until the menu is displayed as shown right.
2. Press the **▶** and then **▲/▼** button to select the **MANUAL PROG.**
3. Press the **▶** button to enter the **MANUAL PROG.** mode.
4. Press the **◀/▶** or **NUMBER** buttons to select the channel number you want to memorize or erase.
5. Press the **▼** button.
6. Press the **◀/▶** button to select **MEMORY** or **ERASE**.
7. Repeat process 3 to 6 to memorize or erase another channels.
8. Press the **ENTER (■)** button to exit.

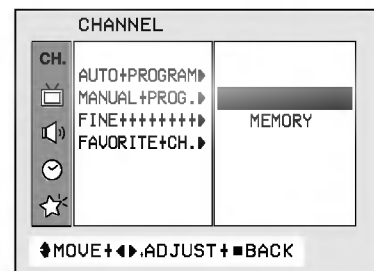
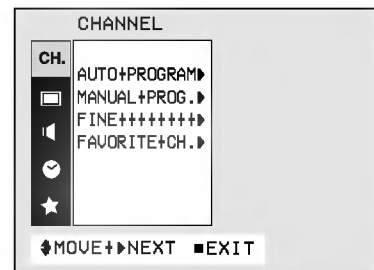

Selecting the Channel

Press the **▲/▼** button to conveniently select the upper or lower channel then the channel being viewed, or **NUMBER** buttons to directly select the desired channel.

Adjusting the Volume

Press the **▶** button to increase the volume level or **◀** button to decrease the volume level.

To mute the sound, press the **MUTE** button.

The word **MUTE** is displayed (It's not displayed in the Caption mode).

It's convenient when you get the telephone calls.

To restore the muted sound, press the **MUTE** button again or **VOL ◀/▶** button.



Setting the Clock

Before setting the on/off timer, first you should set the current time.

1. Press the **MENU** button until the menu is displayed as shown right.
2. Press the **▶** and then **▲ / ▼** button to select **CLOCK**.
3. Press the **▶** button to enter the **CLOCK** mode.
4. Press the **▲ / ▼** button to adjust the hour.
5. Press the **◀ / ▶** button to select the minute position and then press the **▲ / ▼** button to adjust the minute.
6. Press the **ENTER (■)** button to exit.

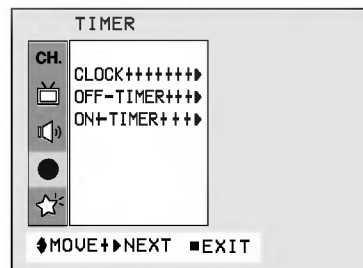

Setting the OFF TIMER

This is the function to automatically switch the TV to standby mode at a preset time.

1. Press the **MENU** button until the menu is displayed as shown right.
2. Press the **▶** and then **▲ / ▼** button to select **OFF-TIMER**.
3. Press the **▶** button to enter the **OFF-TIMER** mode.
4. Press the **▲ / ▼** button to adjust the hour.
5. Press the **◀ / ▶** button to select the minute position and then press the **▲ / ▼** button to adjust the minute.
6. **RUN/HOLD** is used to activate or deactivate preset on/off times. Press the **◀ / ▶** button to select **HOLD** or **RUN** position and then press the **▲ / ▼** button to select **HOLD** or **RUN**.
7. Press the **ENTER (■)** button to exit.

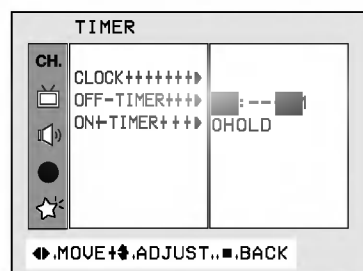
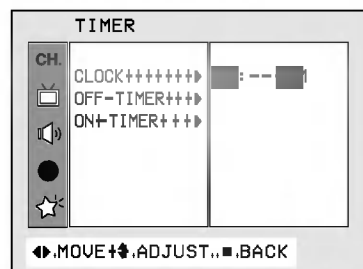

Note: If the same time is set for the on time and off time, only the off time operates.

Setting the ON TIMER

This is the function to automatically turn the TV on at a preset time and channel.

1. Press the **MENU** button until the menu is displayed as shown right.
2. Press the **▶** and then **▲ / ▼** button to select **ON-TIMER**.
3. Press the **▶** button to enter the **ON-TIMER** mode.
4. Repeat OFF TIMER process 4 to 5.
5. Press the **◀ / ▶** button to select the channel position and then press the **▲ / ▼** button to adjust the desired channel.
6. Press the **◀ / ▶** button to select the volume position and then press the **▲ / ▼** button to adjust the desired volume.
7. Press the **◀ / ▶** button to select **HOLD** or **RUN** position and then press the **▲ / ▼** button to select **HOLD** or **RUN**.
8. Press the **ENTER (■)** button to exit.

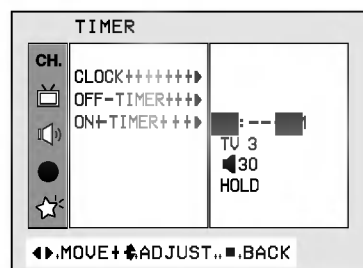

Note: Two hours after the set is switched on by the on timer function, it will automatically switched back to standby mode unless a button has been pressed.

Setting the Sleep Time

You don't have to remember to switch the TV to standby mode before you go to sleep. The sleep timer automatically turns the TV off after the preset time elapses.

Press the **SLEEP** button to select the desired sleep time.

Each time you press this button, the sleep time is displayed one by one as shown below.

The timer begins to count down from the number of minutes selected.

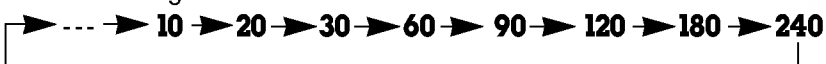

Notes: • After 30 seconds, the desired sleep time will disappear and be operated automatically.

- To view the remaining sleep time, press the **SLEEP** button once and the remaining sleep time will be displayed.
- To cancel the sleep time, select the **SLEEP ---** mode by using the **SLEEP** button.



Auto Off

If there is no input signal, the TV is switched to standby mode automatically in 10 minutes.

1. Press the **MENU** button until the menu is displayed as shown right.
2. Press the **▶** and then **▲/▼** button to select **AUTO OFF**.
3. Press the **▶** button to enter the **AUTO OFF** mode.
4. Press the **▲/▼** button to select **ON** or **OFF**.
5. Press the **ENTER (■)** button to exit.

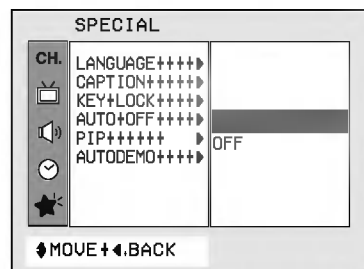

Key Lock

The TV can be set so that the remote control is needed to control it. This feature can be used to prevent unauthorized viewing.

1. Press the **MENU** button until the menu is displayed as shown right.
2. Press the **▶** and then **▲/▼** button to select **KEY LOCK**.
3. Press the **▶** button to enter the **KEY LOCK** mode.
4. Press the **▲/▼** button to select **ON** or **OFF**.
5. Press the **ENTER (■)** button to exit.

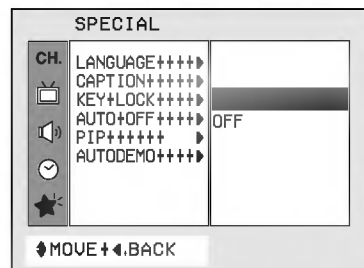

With the key lock on, the display **KEY LOCK** appears on the screen if any button on the front panel is pressed while viewing the TV.

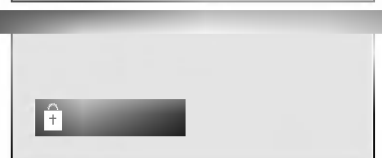

Auto Demonstration

Auto demonstration allows you to review all the menus programmed in the TV set.

1. Press the **MENU** button until the menu is displayed as shown right.
2. Press the **▶** and then **▲/▼** button to select **AUTODEMO**.
3. Press the **▶** button, and the demonstration starts.

When the demonstration reaches the last display, it starts again from the beginning.

To stop auto demonstration, press any button.

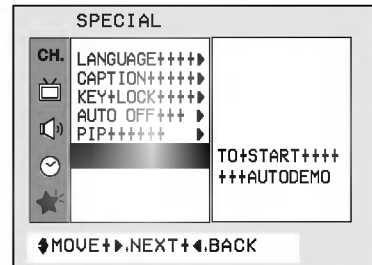

Adjusting the Fine Tuning

This function is to adjust the picture to stable condition when it is poor, for example, a horizontal stripe, twisted picture or no color in broadcasting.

1. Press the **MENU** button until the menu is displayed as shown right.
2. Press the **▶** and then **▲/▼** button to select **FINE**.
3. Press the **▶** button to enter the **FINE** mode.
4. Press the **◀/▶** button to tune the desired picture condition.
5. Press the **ENTER (■)** button to memorize.

- Notes :**
- To release the memorized fine tuning, program again the fine-tuned channel by AUTO PROGRAM or MANUAL PROGRAM.
 - If the finely tuned channel is memorized, the color of the channel number changes to yellow.

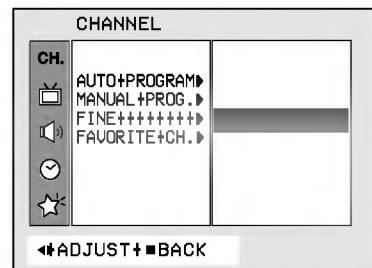

Favorite channel memory

Favorite channel memory is a convenient feature that lets you quickly scan up to five channels of your choice without having to wait for the TV to scan through all the in-between channels.

Using the MENU button

1. Press the **MENU** button until the menu is displayed as shown right.
2. Press the **▶** and then the **▲/▼** button to select **FAVORITE CH.**
3. Press the **▶** button to enter the **FAVORITE CH.** mode.
4. Press the **▲/▼** button to memorize a favorite channel.
5. Press the **◀/▶** button to select the desired channel number.
6. Repeat steps 4 to 5.
7. Press the **ENTER (■)** button to exit.

To select the favorite channel, repeatedly press the **FCR** (Favorite Channel Review) button. Five channels programmed appear on the screen one by one.

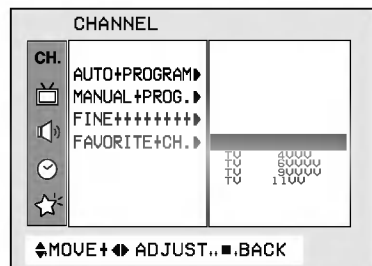
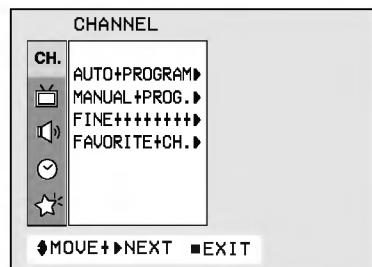

Enjoying the Eye Function

The set will automatically adjust the picture according to the surrounding conditions with the display **MAGIC EYE**.

1. Press the **EYE** button on the remote control.
2. The display **MAGIC EYE** appears and the picture is adjusted automatically.

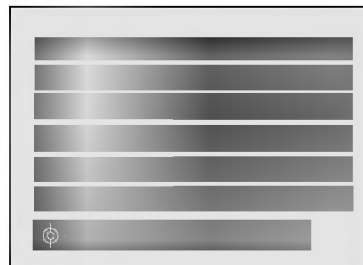

Auto Picture Control

You can select picture modes programmed at factory as you prefer.

Using the APC button

1. Press the **APC** button.
2. Press the **◀ / ▶** or **APC** button to select **MAGIC EYE**, **CLEAR**, **OPTIMUM**, **SOFT** or **USER**.
3. Press the **ENTER (■)** button to exit.



Using the MENU button

1. Press the **MENU** button until the menu is displayed as shown right.
2. Press the **▶** and then **▲ / ▼** button to select **AUTO PICTURE**.
3. Press the **▶** button to enter the **AUTO PICTURE** mode.
4. Press the **▲ / ▼** button to select **MAGIC EYE**, **CLEAR**, **OPTIMUM**, **SOFT** or **USER**.
5. Press the **ENTER (■)** button to exit.

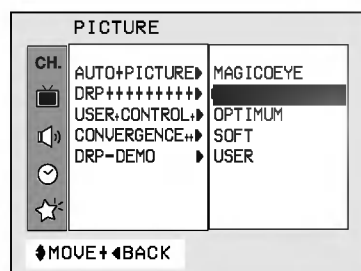

Adjusting the Picture

This is the function to manually adjust the desired picture levels (**CONTRAST**, **BRIGHTNESS**, **COLOR**, **TINT**, **SHARPNESS**) of the screen as you like. If the picture you set is not satisfactory, you can select a factory preset picture. In the broadcasting system PAL-M/N, the picture item **TINT** is inactivated.

1. Press the **MENU** button until the menu is displayed as shown right.
2. Press the **▶** and then **▲ / ▼** button to select **USER CONTROL**.
3. Press the **▶** button to enter the **USER CONTROL** mode.
4. Press the **▲ / ▼** button to select the desired picture mode.
5. Press the **▶** button to enter the desired picture mode.
6. Press the **◀ / ▶** button to adjust the level.
The level of displayed picture mode is adjusted.
7. Press the **ENTER (■)** button to exit.

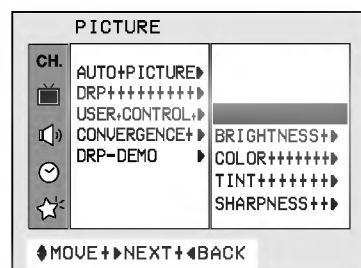

DRP(Digital Reality Picture)

This is the function to stress picture outline in showing a dark area light.

1. Press the **MENU** button until the menu is displayed as shown right.
2. Press the **▶** and then **▲/▼** button to select **DRP**.
3. Press the **▶** button to enter the **DRP** mode.
4. Press the **▲/▼** button to select **CLEAR** or **SOFT**.
5. Press the **ENTER (■)** button to exit.

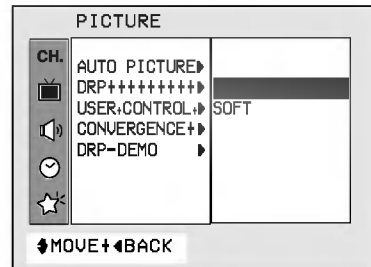

CONVERGENCE

This is the function to adjust the color convergence of screen during receiving the signal. When the TV is first installed or it is relocated, the picture may be unstable with three color ghosts (red, green, blue). This problem can be solved by adjusting the color convergence.

1. Press the **MENU** button until the menu is displayed as shown right.
2. Press the **▶** and then **▲/▼** button to select **CONVERGENCE**.
3. Press the **▶** button to enter the **CONVERGENCE** mode.
If the display + are unstable with three color ghosts, the color convergence needs to be adjusted. If the display + is white, color convergence adjustment is not necessary.
4. Press the **TV/VIDEO** button.
The display **◆◀▶** button is selected in red or blue.
5. Press the **▲/▼/◀/▶** button to superimpose the display + (red or blue) with green one. It will be changed to yellow or cyan.
6. If both red and blue display + is superimposed with the green one, the display + will be changed to white.
7. Press the **ENTER (■)** button to exit.

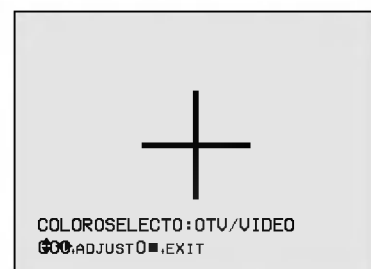
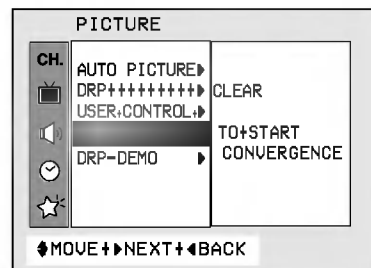

DRP-DEMO

Being divided into two, the screen is shown clear on the left and soft on the right.

1. Press the **MENU** button until the menu is displayed as shown right.
2. Press the **▶** and then **▲/▼** button to select **DRP-DEMO**.
3. Press the **▶** button to enter the **DRP-DEMO** mode.
4. Press the **▶** button, and the demonstration starts.

To stop DRP demonstration, press any button.

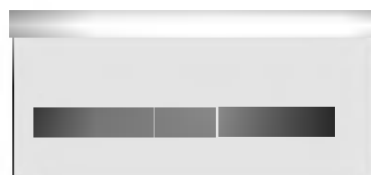
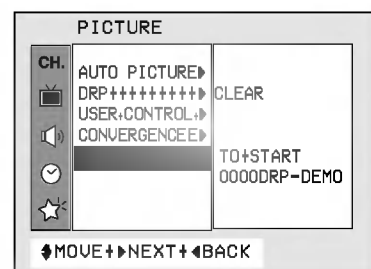

Enjoying the Stereo/SAP Broadcast

This TV set can receive MTS stereo programs and any SAP (Secondary Audio Program) that accompanies the stereo program, as the system to be transmitted one additional sound signal as well as the original one. MTS function doesn't operate in the video mode.

Using the MTS Button

1. Press the **MTS** button to select your desired MTS mode.
Each time you press this button or the ◀ / ▶ button, the **MONO**, **STEREO** or **SAP** mode appears in turn.
2. Press the **ENTER** (■) button to exit.



Using the MENU Button

1. Press the **MENU** button until the menu is displayed as shown right.
2. Press the ▶ and then ▲/▼ button to select **MTS**.
3. Press the ▶ button to enter the **MTS** mode.
4. Press the ▲/▼ button to select **MONO**, **STEREO** or **SAP**.
5. Press the **ENTER** (■) button to exit.

Notes: • The stereo or SAP can be broadcast only when the TV station transmits its signal even though you have selected **STEREO** or **SAP**.

- The mono sound is automatically broadcast in case of mono broadcast even when the **STEREO** or **SAP** has been selected.
- Select **MONO** if you want to listen to the mono sound in the fringe area during stereo/SAP broadcasting.

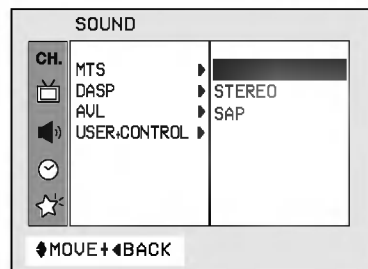
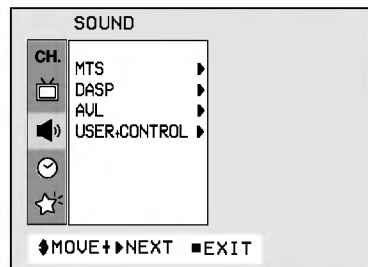

AVL (Auto Volume Leveler)

AVL automatically keeps on an equal volume level even if you change channels.

Using the AVL Button

1. Press the **AVL** button.
2. Press the ◀/▶ or **AVL** button to select **ON** or **OFF**.
3. Press the **ENTER** (■) button to exit.

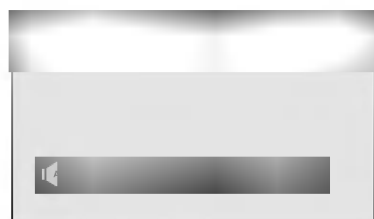

Using the MENU Button

1. Press the **MENU** button until the menu is displayed as shown right.
2. Press the ▶ and then ▲/▼ button to select **AVL**.
3. Press the ▶ button to enter the **AVL** mode.
4. Press the ▲/▼ button to select **ON** or **OFF**.
5. Press the **ENTER** (■) button to exit.

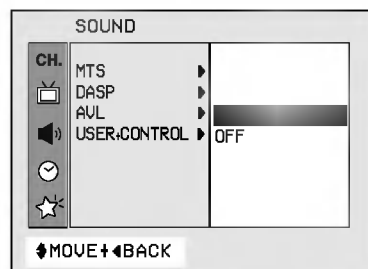

Auto Sound Control

You can enjoy the best sound without any special adjustment because this TV set automatically adjusts the sound appropriate to viewing program character by self-intelligence.

Pro Logic can be selected only in PP-48/53A80P models.

Using the DASP Button

1. Press the **DASP** button.
2. Press the **◀/▶** or **DASP** button to select **Pro Logic**, **Virtual**, **CINEMA**, **MUSIC**, **SPORTS** or **USER**.
3. Press the **ENTER (■)** button to exit.

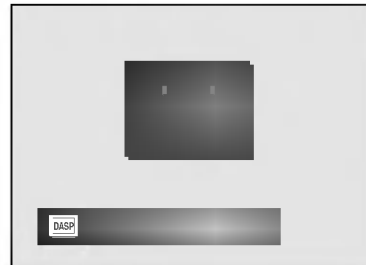

Using the MENU Button

1. Press the **MENU** button until the menu is displayed as shown right.
2. Press the **▶** and then the **▲/▼** button to select **DASP**.
3. Press the **▶** button to enter the **DASP** mode.
4. Press the **▲/▼** button to select **Pro Logic**, **Virtual**, **CINEMA**, **MUSIC**, **SPORTS** or **USER**.
5. Press the **ENTER (■)** button to exit.

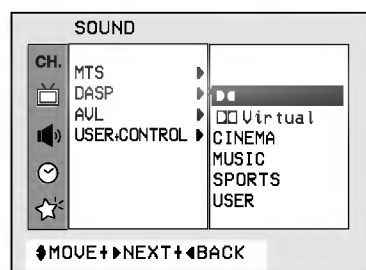

How to enjoy Pro Logic

1. Press the **MENU** button until the **SOUND** menu is displayed.
2. Press the **▶** and then the **▲/▼** button to select **DASP**.
3. Press the **▶** button to enter the **DASP** mode.
4. Press the **▲/▼** button to select **Pro Logic** and then press the **▶** button.
5. Press the **▲/▼** button to select a desired center mode; **3 STEREO**, **PHANTOM**, **WIDE**, **NORMAL**

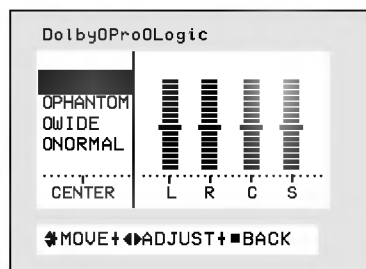

3 STEREO

This mode is suitable to use in case of no installing the surround speakers. The sound is output from right, left and center speakers during Dolby Surround or Stereo broadcast reception only, but during Mono broadcast reception the sound is output from the center speaker only.

(Three speakers are still displayed even during Mono broadcast reception.)



<3STEREO>

PHANTOM

This mode is suitable to use in case of no installing the center speaker. The sound is output from right, left and surround speakers.

WIDE

The sound is output from right, left, center and surround speakers. Especially the center speaker covers all the sound range (from bass to treble).

NORMAL

The sound is output from right, left, center and surround speakers. The bass sound isn't output from the center speaker, instead it is output from the right and left speakers.

- Notes:**
- Manufactured under license from Dolby Laboratories. "Dolby", "Pro Logic" and the double-D symbol are trademarks of Dolby Laboratories.
 - If you select the **Pro Logic**, the **AVL** is inactivated and in **USER CONTROL** mode, **BASS** and **TREBLE** can be adjusted instead of **BALANCE** and **EQUALIZER**.
 - If **Pro Logic** produces program which isn't recorded to Dolby surround, it can't produce right effect.
 - When **Virtual** gives special effect to surround signal of **Pro Logic**, sound is produced through left and right speakers. In other words, you can get similar effect that **Pro Logic** produces through left, right, center and surround speakers.

6. Press the **</>** button to select a speaker channel. Inactivated speaker can't be selected and adjusted.
7. Press the **▲/▼** button to adjust the speaker volume. At this moment the selected speaker outputs noise.
8. Press the **ENTER (■)** button to exit.



<PHANTOM>



<WIDE / NORMAL>

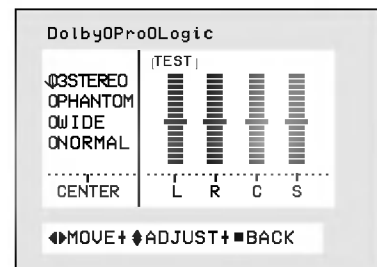

Adjusting the equalizer

1. Press the **MENU** button until the menu is displayed as shown right.
2. Press the **▶** and then the **▲/▼** button to select **USER CONTROL**.
3. Press the **▶** button to enter the **USER CONTROL** mode.
4. Press the **▲/▼** button to select **EQUALIZER**.
5. Press the **▶** button to enter the **EQUALIZER** mode.
6. Press the **◀/▶** button to select the sound band and then press the **▲/▼** button to adjust the desired level.
7. Press the **ENTER (■)** button to exit.

Note: In **□□ Pro Logic** mode, you cannot select **EQUALIZER**.

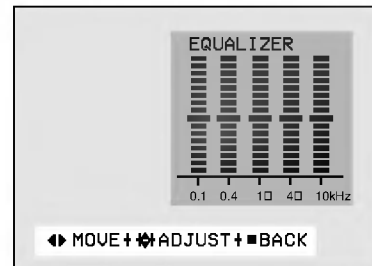
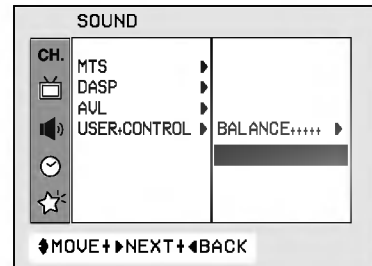

Adjusting the balance

1. Press the **MENU** button until the menu is displayed as shown right.
2. Press the **▶** and then the **▲/▼** button to select **USER CONTROL**.
3. Press the **▶** button to enter the **USER CONTROL** mode.
4. Press the **▲/▼** button to select **BALANCE**.
5. Press the **▶** button to enter the **BALANCE** mode.
6. Press the **◀/▶** button to adjust the balance level.
7. Press the **ENTER (■)** button to exit.

Note: In **□□ Pro Logic** mode, you cannot select **BALANCE**.



Watching the PIP (Picture in Picture)

This is the function to call up a little picture (PIP : picture in picture) within the main picture. Thus at the same time you can watch two different programs.

1. Press the **PIP** button to select PIP mode.
2. Press the **CH▲ / CH▼** button of the PIP buttons to select the desired channel in the sub picture.

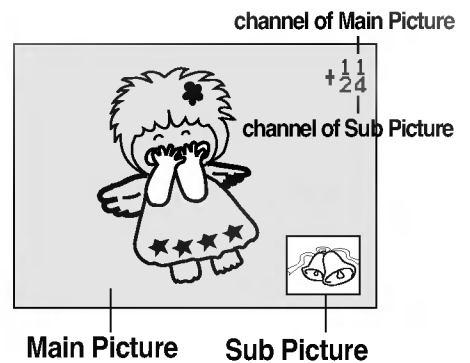

Selecting the input signal (in PIP mode)

Using the PIP MENU Button

1. Press the **PIP MENU** button.
2. Press the **▲/▼** button to select **INPUT**.
3. Press the **▶** and then **▲/▼** button to select **TV, VIDEO 1, VIDEO 2, VIDEO 3**.
4. Press the **ENTER (■)** button to exit.

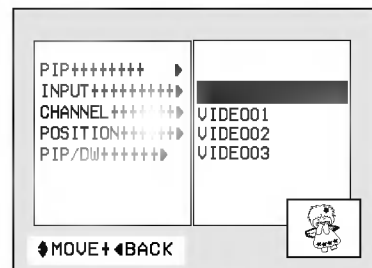

Using the MENU Button

1. Press the **MENU** button until the menu is displayed as shown right.
2. Press the **▶** and then the **▲/▼** button to select **PIP**.
3. Press the **▶** button to enter the **PIP** mode.
4. Press the **▲/▼** button to select **INPUT**.
5. Press the **▶** and then **▲/▼** button to select **TV, VIDEO 1, VIDEO 2, VIDEO 3**.
6. Press the **ENTER (■)** button to exit.

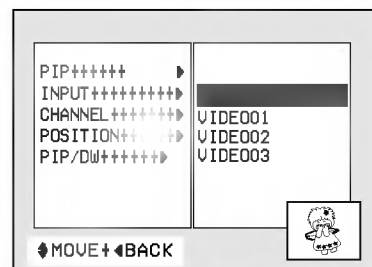
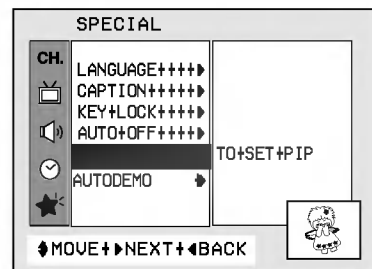

Moving the Sub Picture (in PIP mode)

Press the **POSITION** button to select the desired position of sub picture.

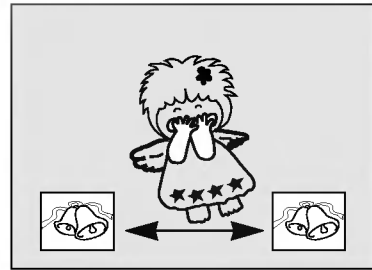

Still Picture

Press the **STILL** button.
The still picture is displayed.
In PIP mode, the still picture is displayed in the sub picture.

To cancel the still picture, press the **STILL** button again.

Note: This function doesn't work in COMPONENT 2 and RGB-PC mode.

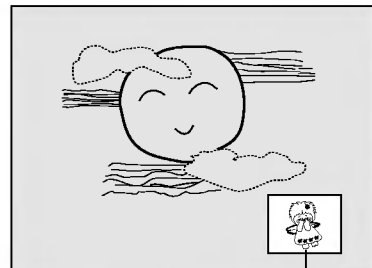

Still picture

Channel Search

This is the function to search one by one the pictures of all the programmed channels through the PIP screen while the main screen remains as a current channel.

Press the **CH. SEARCH** button.
The pictures of all the programmed channels are searched through one PIP screen, as shown right.

To release the channel search, press the **CH. SEARCH** or **ENTER (■)** button.

Note: By pressing the **SWAP** button, you can see the channel being searched on the PIP screen through the main screen.

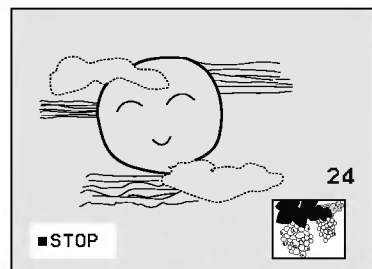

Swapping Screens

Press the **SWAP** button.
Each time you press this button, the main picture and sub picture exchange places.

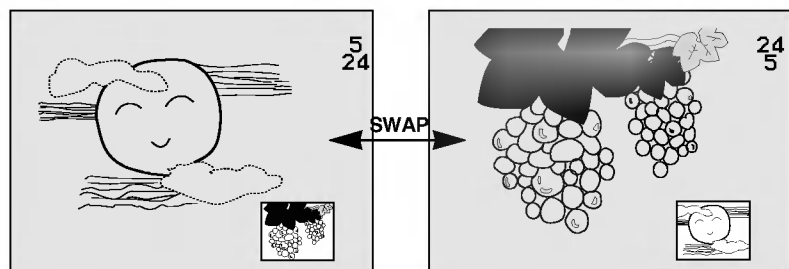

Closed captioning is a process which converts the audio portion of a television program into written words, which then appear on the television screen in a form similar to subtitles. Closed captions allow viewers to read the dialogue and narration of television programs.

Using Closed Captions

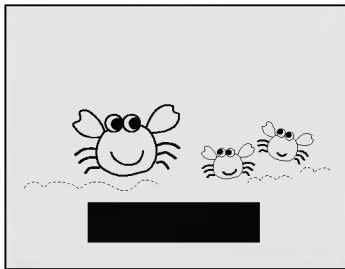

Captions are the subtitles of the dialogue and narration of television programs. For prerecorded programs, program dialogue can be arranged into captions in advance. It's possible to caption a live program by using a process called "real-time captioning", which creates captions instantly. Real-time captioning is normally done by professional reporters using a machine shorthand system and computer for translation into English.

Captioning is an effective system for the hearing-impaired, and it can also aid in teaching language skills.

- The picture at left shows a typical caption.

Caption Tips

- Not all TV broadcasts include closed caption signals.
- Sometimes TV stations broadcast two different caption signals on the same channel. By selecting MODE 1 or MODE 2, you can choose which signal you view. MODE 1 is usually the signal with the captions, while MODE 2 might show demonstration or programming information.
- Your TV might not receive caption signals normally in the following situations.

1 Poor reception conditions are encountered:



■ **IGNITION:**

Picture may flutter, drift, suffer from black spots or horizontal streaking. Usually caused by interference from automobile ignition systems, neon lamps, electrical drills and other electrical appliances.



■ **GHOSTS:**

Ghosts are caused when the TV signal splits and follows two paths. One is the direct path and the other is reflected off tall buildings, hills or other objects. Changing the direction or position of the antenna may improve reception.



■ **SNOW:**

If your receiver is located at the weak, fringe area of a TV signal, your picture may be marred by small dots. It may be necessary to install a special antenna to improve the picture.

2 An old, bad or illegally recorded tape is played.

3 Strong, random signals from a car or airplane interfere with the TV signal.

4 The signal from the antenna is weak.

5 The program wasn't captioned when it was produced, transmitted or taped.

Using the Text Function

Text services give a wide variety of information on all kind of subjects (ex. captioned program lists, weather forecasts, stock exchange topics, news for hearing-impaired---) through the full TV screen.

But not all stations offer text services, even though they might offer captioning.

Note: In the event you receive a poor signal, an empty black box may appear and disappear, even when the text mode is selected. This is normal function in such an event.

Operating the Caption and Text

Using the CAPTION button

1. Press the **CAPTION** button.
2. Press the ◀ / ▶ or **CAPTION** button to select **MODE 1, MODE 2, TEXT 1, TEXT 2** or **OFF**.
3. Press the **ENTER** (■) button to exit.

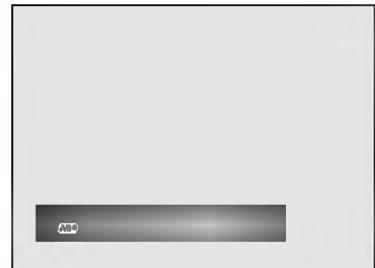

Using the MENU button

1. Press the **MENU** button until the menu is displayed as shown right.
2. Press the ▶ and then ▲/▼ button to select **CAPTION**.
3. Press the ▶ button to enter the **CAPTION** mode.
4. Press the ▲/▼ button to select **MODE 1, MODE 2, TEXT 1, TEXT 2** or **OFF**.
5. Press the **ENTER** (■) button to exit.

Note: This TV is programmed to remember which mode it was last set to, even if you switch the set to standby mode.

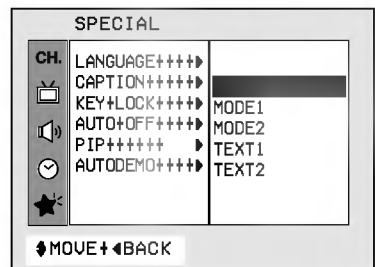
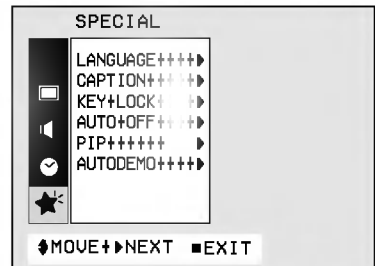

Antenna Connections

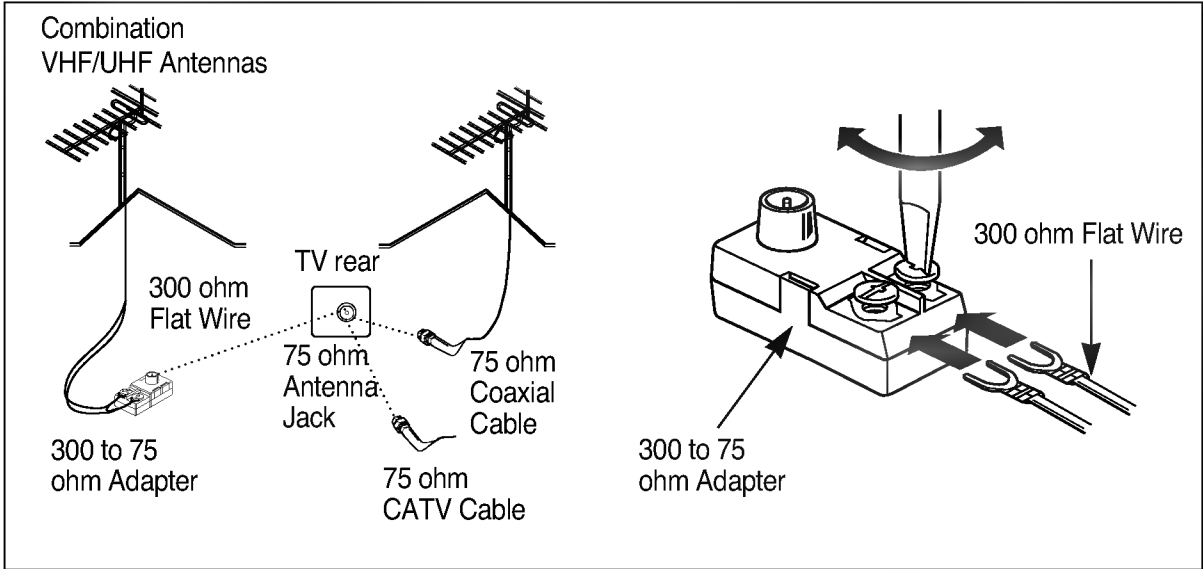

Connecting an Outdoor Antenna

For the best reception, we recommend you use an outdoor antenna. Severely weathered antennas and antenna cables can reduce the signal quality. Before connecting it, necessarily inspect them. Any service center can explain the various outdoor antennas available to you.

300 Ohm Flat Wire

1. Connect the 300 ohm flat wire to screws on the 300 ohm to 75 ohm adapter.
2. Push the end of 300 ohm to 75 ohm adapter into 75 ohm antenna jack.

75 Ohm Coaxial Cable

1. Connect the 75 ohm coaxial cable directly to the 75 ohm antenna jack.

Connecting a CATV Cable

If you subscribe to a CATV system, change the antenna connection as described below.

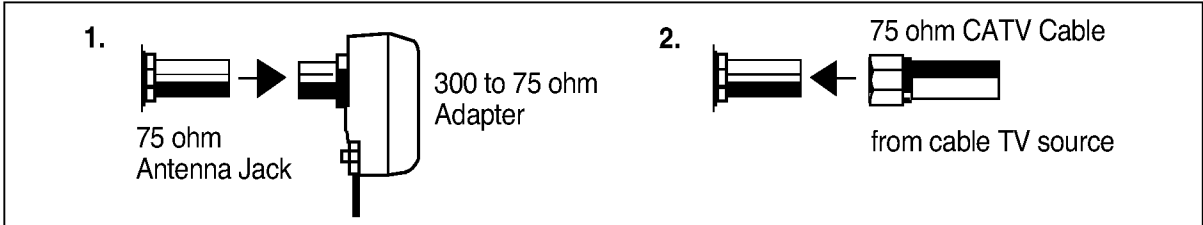

1. Remove the 300 to 75 ohm adapter or the cable from the set if attached.
2. Connect the CATV cable (75 ohm coaxial cable) to the 75 ohm antenna jack.

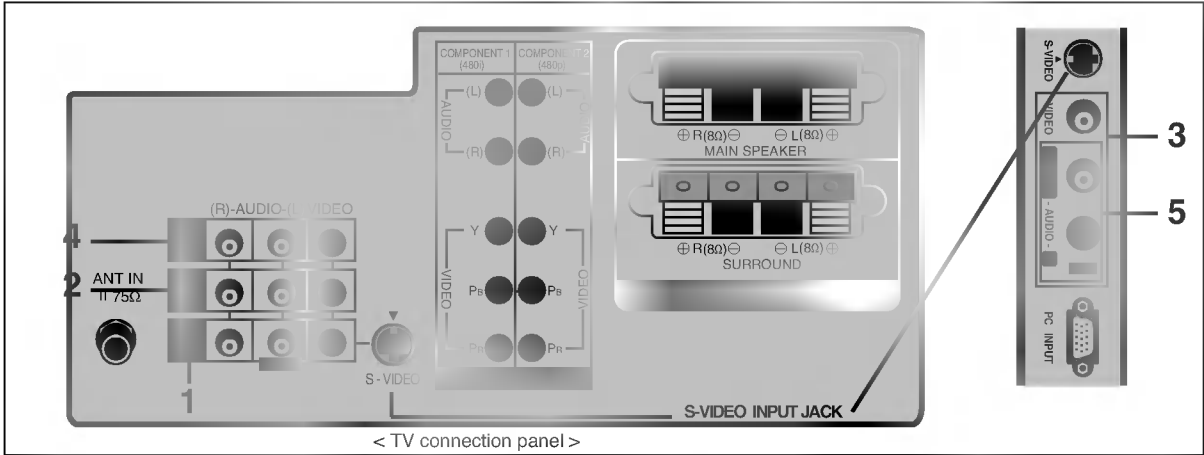

1. **IN 1 JACKS** : Connect external equipment outputs (VCR, LASER DISC, CAMCORDER) to these inputs. Press the **TV/VIDEO** button to select **VIDEO-1**.
2. **IN 2 JACKS** : Connect external equipment outputs (VCR, LASER DISC, CAMCORDER) to these inputs. Press the **TV/VIDEO** button to select **VIDEO-2**.
3. **IN 3 JACKS** : Connect external equipment outputs (VCR, LASER DISC, CAMCORDER) to these inputs. Press the **TV/VIDEO** button to select **VIDEO-3**.
4. **OUT JACKS** : Connect external equipment inputs (VCR, Audio amplifier) to these outputs for recording or monitoring the selected program.
5. **PC SOUND INPUT JACKS**

Connecting AUDIO/VIDEO IN Jacks

1. Connect the audio/video output jacks of the VCR to **IN 1** or **IN 2(A/V)** jacks on the back.
2. Press the **TV/VIDEO** button to select **VIDEO-1** or **VIDEO-2**.

Note: If you connect the audio/video output jacks of the VCR to the **IN 3 (A/V)** jacks on the side of TV, select **VIDEO-3**.

3. Press the **PLAY** button on the VCR.
The video playback is on the TV screen.

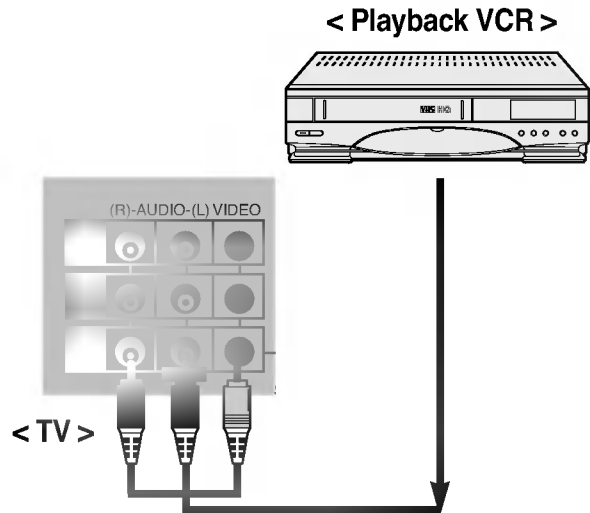

Note: In case of MONO VCR, connect the output jack of VCR to the **AUDIO-(L)/(MONO) IN 1** or **IN 3** jack of TV so that the sound can be heard from both speakers. If you connect it to the **AUDIO-(R) IN** jack of TV the sound is heard only from right speaker.

Connecting the S-VHS VCR

Connecting the S-VIDEO jacks

1. Connect the S-VHS output jacks of the VCR to the **S-VIDEO** jack on the back.

Remember to connect the audio cables from the VCR to the **IN1** audio jacks on the TV.

2. Press the **TV/VIDEO** button to select **VIDEO-1**.

Note: If you connect the S-VHS/audio output jacks of the VCR to the **S-VIDEO** jack and **IN 3** audio jacks on the side of TV, select **VIDEO-3**.

3. Press the **PLAY** button on the VCR.
The video playback is on the TV screen.

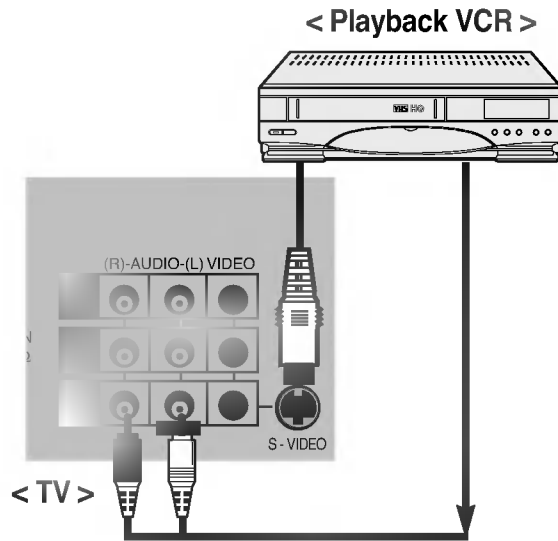

Recording Onto VCR

1. Connect the audio/video input jacks of the recording VCR to the **OUT (A/V)** jacks on the back.
2. Select the program number on the TV.
3. Set the recording VCR to record.

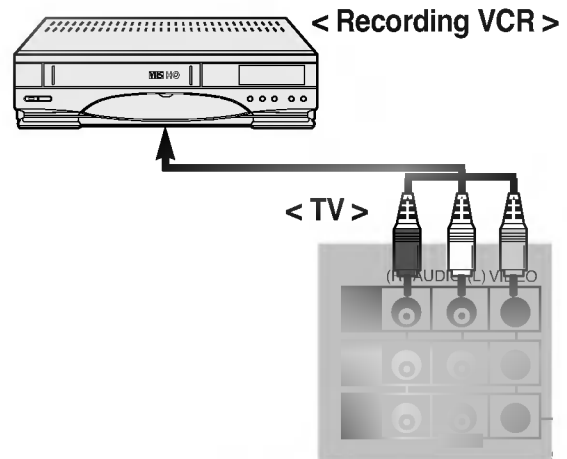

Recording a program from connected other equipment

1. Connect the output jacks of the playback VCR to the **IN 1** or **IN 2 (A/V)** jacks on the back of TV (or **IN 3** jacks on the side of TV).
2. Connect the input jacks of the recording VCR to the **OUT (A/V)** jacks on the back of TV.
3. Press the **TV/VIDEO** button to select **VIDEO-1** or **VIDEO-2**.

If you connect it to the **IN 3 (A/V)** jacks on the side of TV, you should select **VIDEO-3**.

4. Press the **PLAY** button on the playback VCR and set the recording VCR to record.

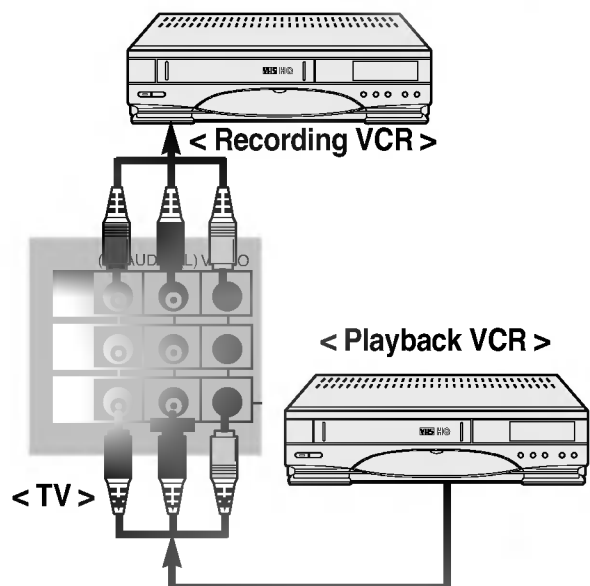

- Connect component video inputs to Y, Pb, Pr and audio inputs to right and left port of AV ports.

1.How to connect

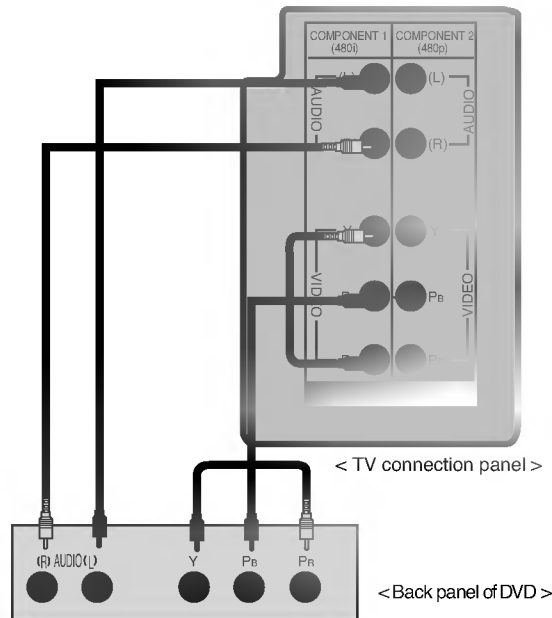

- Note:**
- Component 1 (480i): Input for interlace - scanning DVD players only.
 - Component 2 (480p): Input for progressive - scanning DVD players only.

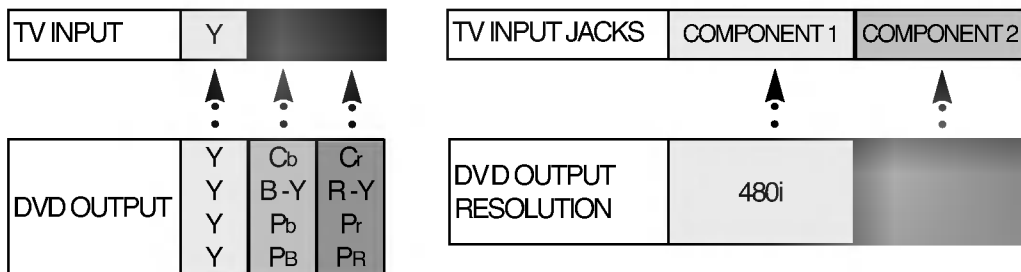

2.How to use

- Turn the TV on and press the **MULTIMEDIA** button on the remote control or **TV/VIDEO** button on the front panel to select **COMPONENT 1** or **2**.

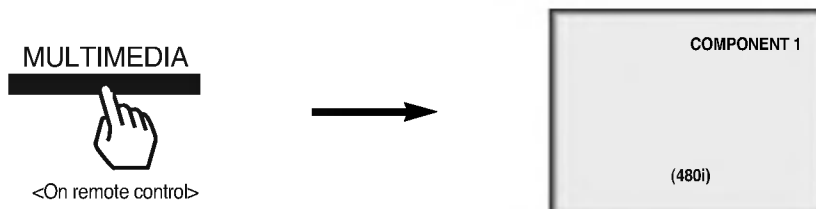

- Try this after turning on the DVD set.

Make sure to select PC mode on before operating.
If turning on the PC after connecting with the set, the screen of the set becomes unstable while the PC is booting because of the frequency difference. So connect the set to the PC with PC signal cable after finishing booting with the monitor for PC.

1.How to connect

- Make sure to set resolution of the PC to be available before connecting. Refer to page 29.
- Connect the set to the PC with PC signal cable.
- Connect the audio ports to the PC to get PC sound.

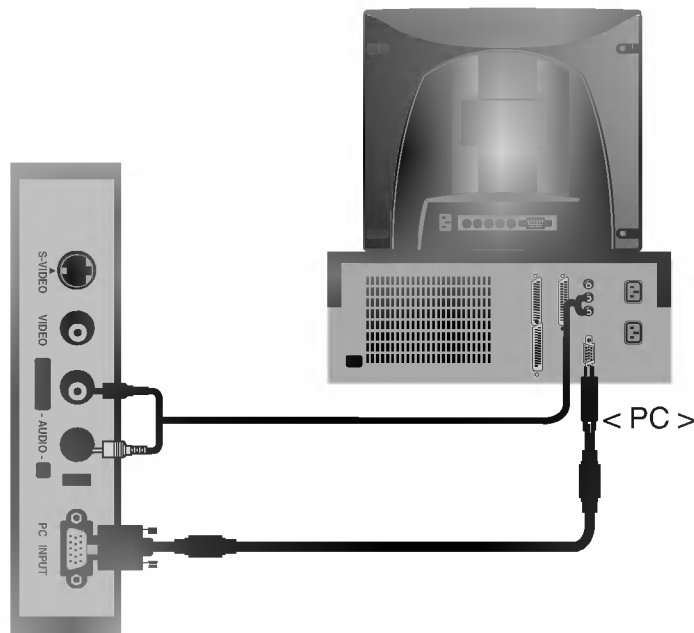

< TV connection panel >

2.How to use.

- Turn the set on and press the **MULTIMEDIA** button on the remote control or **TV/VIDEO** button on the front panel to select **RGB-PC**.

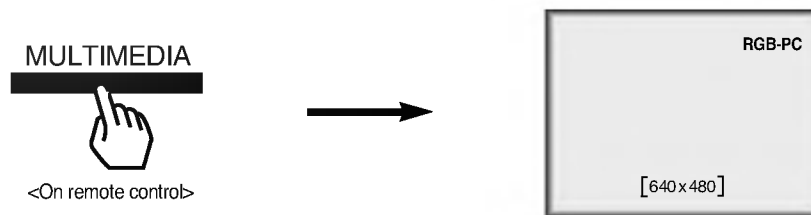

- Try this after turning on the PC set.

MODE	Resolution	Horizontal Frequency (KHz)	Vertical Frequency (Hz)
VGA	640x480	31.5KHz	60Hz

Note: •PC display resolution : 640 x 480

Make sure to select PC mode on before operating.

3.Adjusting Picture in PC mode.

1. Press the MENU button.

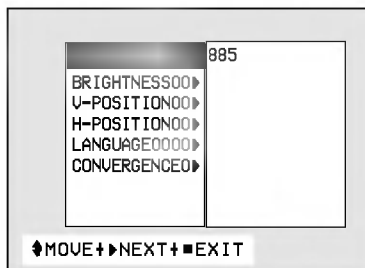

2. Press the ▲ / ▼ button to select a desired picture item and then Press the ◀ / ▶ button to adjust the level.

•You can control vertical position -2 to +2, horizontal position -10 to +10.

3. Press the ENTER (■) button.

Note: In the PC mode, You can use functions of LANGUAGE and CONVERGENCE as same way which is used in TV mode. Refer to Page 8, 15.

SYMPTOMS

No power

No picture or sound

Poor picture but good sound

Poor reception

Lines in picture

Ghosts (multiple images)

Remote control does not work.

Cannot tune desired channel.

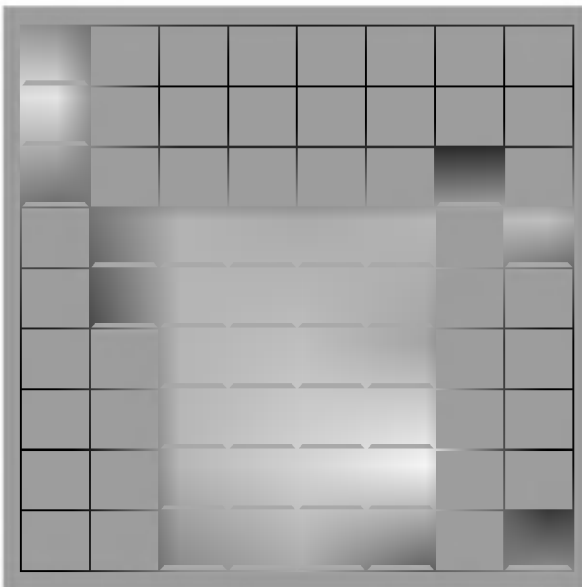

CHECK THESE THINGS

- Is power cord plugged in?
- Is television turned on?
- Check batteries in remote control.
- Try another channel (station trouble).
- Check antenna connectings.
- Check for local interference.
- Adjust the antenna.
- Adjust the picture control.
- Program channel using AUTO PROGRAM.

