

Introduction

Thank you for purchasing a high resolution monitor. It will give you high resolution performance and convenient reliable operation in a variety of video operating modes.

ENGLISH

Features

- The monitor is a 17 inches (16.0 inches viewable) intelligent, microprocessor based monitor compatible with most analog RGB (Red, Green, Blue) display standards, including IBM PC®, PS/2®, Apple®, Macintosh®, Centris®, Quadra®, and Macintosh II family.
- The monitor provides crisp text and vivid color graphics with VGA, SVGA, XGA, and VESA Ergonomic modes (non-interlaced), and most Macintosh compatible color video cards when used with the appropriate adaptor. The monitor's wide compatibility makes it possible to upgrade video cards or software without purchasing a new monitor.
- Digitally controlled auto-scanning is done with the micro-processor for horizontal scan frequencies between 30 and 70kHz, and vertical scan frequencies between 50-160Hz.
- This monitor is capable of producing a maximum horizontal resolution of 1280 dots and a maximum vertical resolution of 1024 lines.
- The microprocessor-based digital controls allow you to adjust conveniently a variety of image controls by using the OSD (On Screen Display).
- Plug and play capability if supported by your system.
- This monitor has DDC 2B function.*
- Compliant with the following regulated specifications :*
 - EPA ENERGY STAR
 - Swedish MPR II
 - Swedish TCO'99

**For detailed information, please refer to the Reference Guide provided.*

- Turn off the equipment and all attached options.
- Carefully set the monitor face-down with the underside facing you.

Installation

1. Align the hooks on the tilt/swivel stand with the matching slots in the base of the monitor.
2. Insert the hooks into slots.
3. Slide the tilt/swivel stand toward the front of the monitor until the latches click into the locked position.

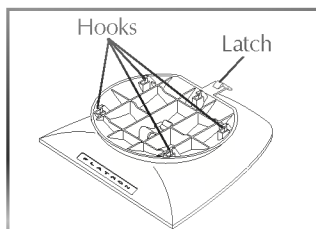
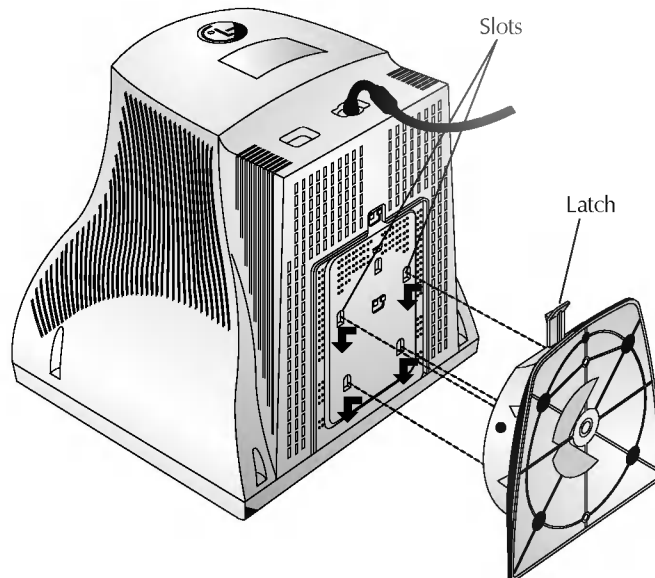

On the back of the monitor are two plug-in connections; one for the AC power cord, and the other for the signal cable from the video card.

- Power off both the monitor and PC.
- Connect the 15 pin VGA connector of the supplied signal cable to the output VGA video connector on the PC and the matching input connector on the rear of the monitor. The connectors will mate only one way. If you cannot attach the cable easily, turn the connector upside down and try again. When mated, tighten the thumbscrews to secure the connection.
- Locate the appropriate MAC to VGA adapter block at your local computer store. This adapter changes the high density 3 row 15 pin VGA connector to the correct 15 pin 2 row connection to mate with your MAC. Attach the other end of the signal cable to the side of the adapter block with 3 rows.

Connect the attached adapter block/signal cable to the video output on your MAC.

- One end of the AC power cord is connected into the AC power connector on the back of the monitor. The other end is plugged into a properly grounded three-prong AC outlet.
- Power on the PC, then the monitor.
- If you see the **SELF DIAGNOSTICS** message, check the signal cable and connectors.
- After using the system, power off the monitor, then the PC.

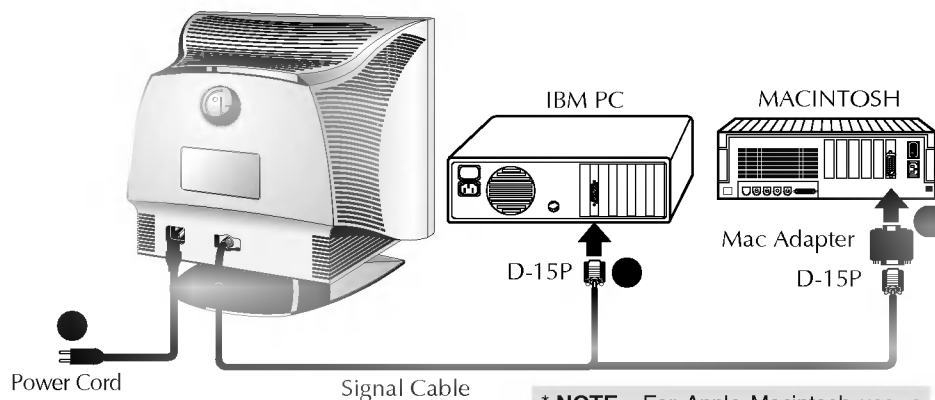

* **NOTE** : For Apple Macintosh use, a separate plug adapter is needed to change the 15 pin high density (3 row) D-sub VGA connector on the supplied cable to a 15 pin 2 row connector.

Location and Function of Controls

Front View

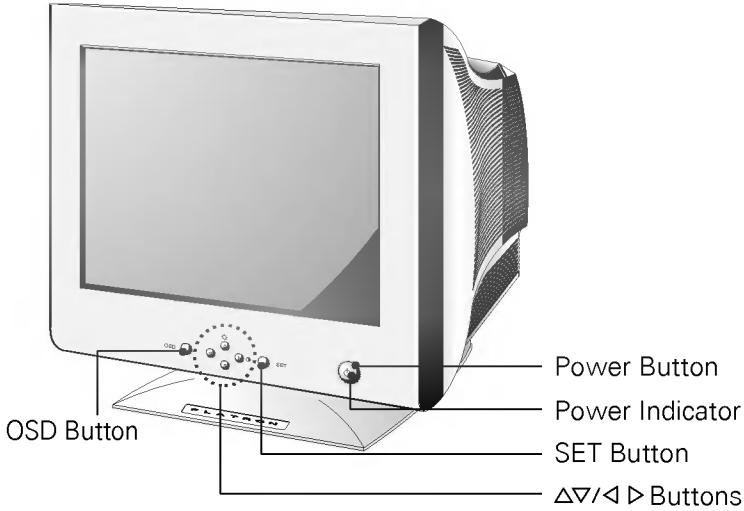

Rear View

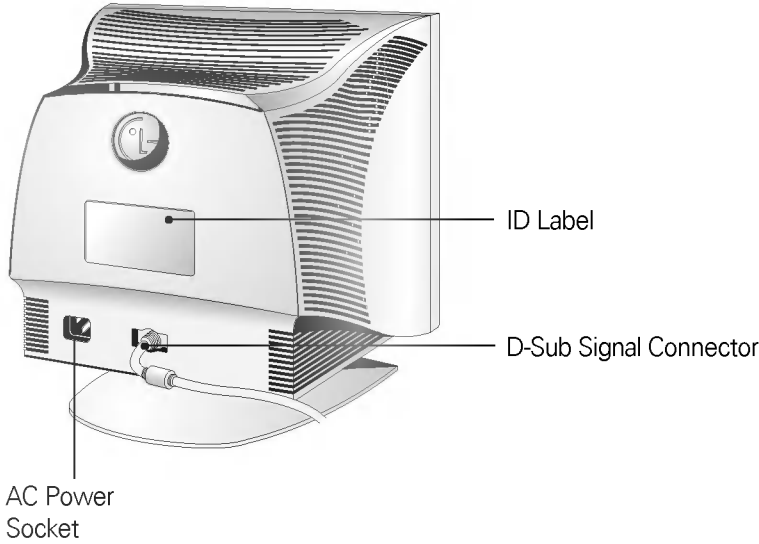

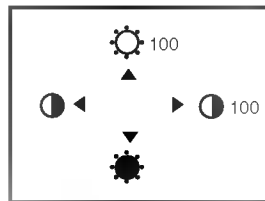
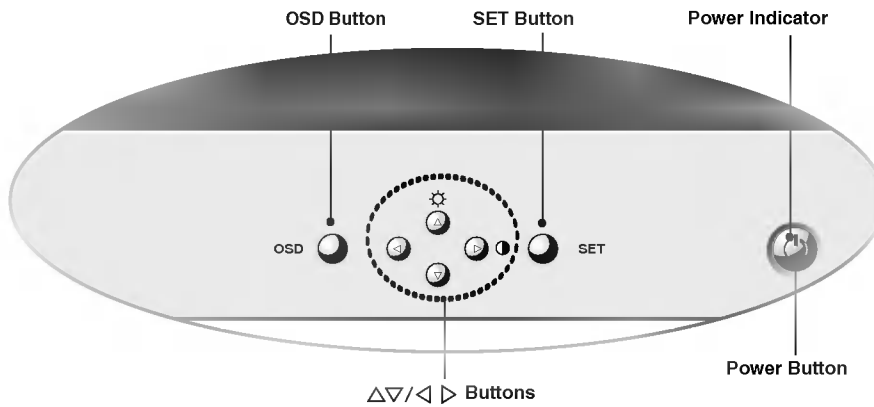

Front Panel Controls

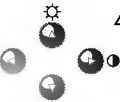

<Shortcut Keys>

- Brightness and Contrast can be adjusted directly without entering the On Screen Display (OSD) system. Press the Δ/\triangleright buttons to display the menu and then the $\Delta/\triangleright/\triangleleft/\triangleright$ buttons to adjust the settings. To save all changes, press the **OSD button**. The Brightness and Contrast functions are also available in the On Screen Display (OSD) menu.

Control	Function
 OSD Button	Use this button to enter or exit the on screen display.
 $\Delta/\triangleright/\triangleleft/\triangleright$ Buttons	Use these buttons to choose or adjust items in the on screen display.
 SET Button	Use this button to enter a selection in the on screen display.
 Power Button	Use this button to turn the monitor on or off.
Power (DPMS) Indicator	The power indicator light is shown in the power button. This Indicator lights up green when the monitor operates normally. If the monitor is in DPM (Energy Saving) mode (stand-by/ suspend/ off), this indicator color changes to amber.



On Screen Display (OSD) Control Adjustment

Making adjustments to the image size, position and operating parameters of the monitor are quick and easy with the On Screen Display Control system. A quick example is given below to familiarize you with the use of the controls. Following section is an outline of the available adjustments and selections you can make using the OSD.

NOTE

- Allow the monitor to stabilize for at least 30 minutes before making image adjustment.

To make adjustments in the On Screen Display, follow these steps:

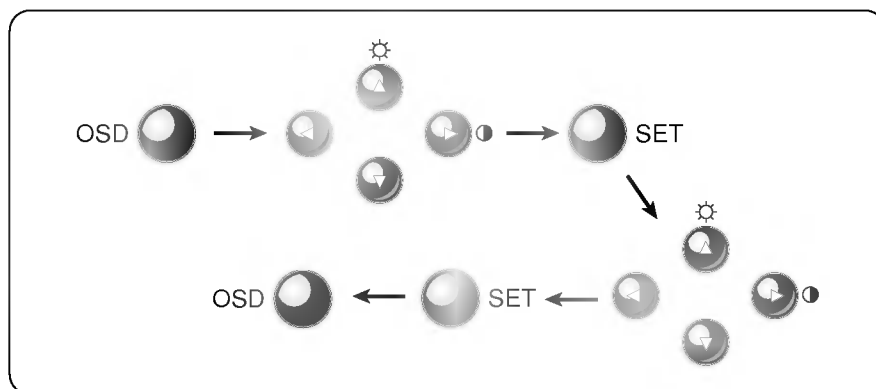





- 1** Press the OSD Button, then the main menu of the OSD appears.
- 2** To access a control, use the Δ or ∇ Buttons. When the icon you want becomes highlighted, press the SET Button.
- 3** Use the $\Delta/\nabla/\leftarrow/\rightarrow$ Buttons to adjust the item to the desired level.
- 4** Accept the changes by pressing the SET Button.
- 5** Exit the OSD by pressing the OSD Button.



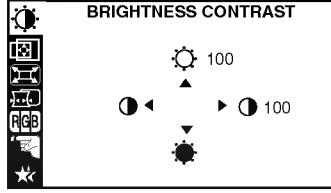



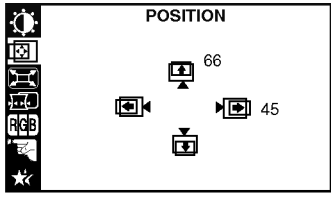



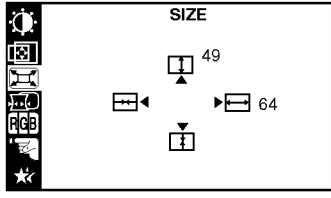

On Screen Display(OSD) Selection and Adjustment

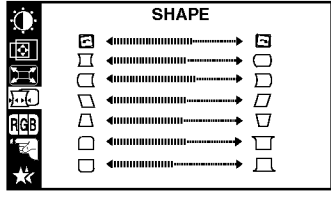
You were introduced to the procedure of selection and adjusting an item using the OSD system. Listed below are the icons, icon names, and icon descriptions of the items that are shown on the Menu.

	<p> Brightness Used to adjust the brightness of the screen.</p> <p> Contrast Adjust the display to the contrast desired.</p>
---	--

	<p> Vertical Position To move image up and down.</p> <p> Horizontal Position To move picture image left and right.</p>
--	--

	<p> Vertical Size To adjust image height.</p> <p> Horizontal Size To adjust image width.</p>
---	--

	<p> Tilt To correct image rotation.</p> <p> Side Pincushion To correct the bowing in and out of the image.</p> <p> Side pincushion balance To correct the balance of both sides bowing.</p> <p> Parallelogram This control adjusts for a skewing of the screen image.</p> <p> Trapezoid To correct geometric distortion.</p> <p> Corner Top To correct the irregular distortion of the displayed image.</p> <p> Corner Bottom To correct the irregular distortion of the displayed image.</p>
---	---



On Screen Display(OSD) Selection and Adjustment

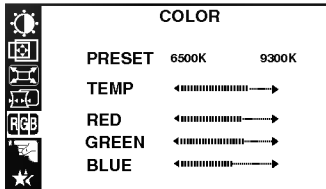

PRESET 6500K / 9300K

To appear the displays color temperature.

- 6500K : Slightly reddish white.
- 9300K : Slightly bluish white.

TEMP User easily color set without adjustment Red, Green and Blue (R/G/B).

RED To set your own color levels.

GREEN To set your own color levels.

BLUE To set your own color levels.

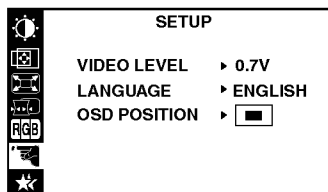

VIDEO LEVEL This item is used to select the monitor's input signal level. The normal level used for most PC's is 0.7V. When the screen suddenly gets brightened or blurry, please select 1.0V and try again.

LANGUAGE To choose the language in which the control names are displayed.

OSD POSITION To adjust position of the OSD window on the screen.

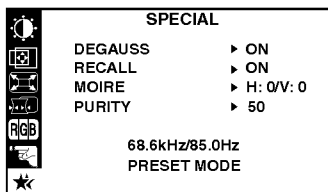

DEGAUSS To manually demagnetize the screen which may show some image or color incorrectly.

RECALL You can use this function when you want to go back to the screen display of the time you purchased the product after adjusting to modify it in the Preset Mode.

When you are in the User mode, you can recall only , , , , , items.

After using Recall, adjust the screen display again if necessary. If you want more information on the Preset Mode, refer to A9 page.

MOIRE This item allows you to reduce the moire (Moire is caused by interference Horizontal Scan Line with the periodical dot screen). It is normally OFF(H:0/V:0).

The moire adjustments may affect the focus of the screen. The screen image may shake slightly while the moire reduction function is on.

PURITY Use to adjust the overall purity of the image if the color appears uneven.

Video Memory Modes

The monitor has 34 memory locations for display modes, 10 of which are factory preset to popular video modes.

Display Modes (Resolution)

	Display Modes (Resolution)	Horizontal Freq.(kHz)	Vertical Freq.(Hz)
1	VESA 640 x 480	37.50	75
2	VESA 800 x 600	46.88	75
3	VESA 800 x 600	53.68	85
4	VESA 1024 x 768	68.677	85
*5	VESA 640 x 400	31.47	70
*6	VESA 640 x 480	31.47	60
*7	VESA 800 x 600	37.88	60
*8	VESA 640 x 480	43.27	85
*9	VESA 1024 x 768	60.02	75
*10	VESA 1280 x 1024	63.98	60

* Pre-loaded mode

User Modes

- Modes 11-34 are empty and can accept new video data. If the monitor detects a new video mode that has not been present before or is not one of the preset modes, it stores the new mode automatically in one of the empty modes starting with mode 11.

If you use up the 24 blank modes and still have more new video modes, the monitor replaces the information in the user modes starting with mode 11.

Recalling Display Modes

- When your monitor detects a mode it has seen before, it automatically recalls the image settings you may have made the last time you used that mode.

You may, however, manually force a recall of each of the 10 preset modes by pressing the Recall button. All preset modes are automatically recalled as the monitor senses the incoming signal.

The ability to recall the preset modes is dependent on the signal coming from your PC's video card or system. If this signal does not match any of the factory modes, the monitor automatically sets itself to display the image.

Troubleshooting

Check the following before calling for service.

SELF DIAGNOSTICS message.

- The signal cable is not connected, or is loose. Check and secure the connection.

OUT OF FREQUENCY message appears.

- The frequency of the signal from the video card is outside the operating range of the monitor.

* Horizontal Frequency : 30-70kHz

* Vertical Frequency : 50-160Hz

Use the graphics board's utility software to change the frequency setting (Refer to the manual for graphics board).

The power LED is illuminated amber.

- Display power management mode.
- There is no active signal coming from the PC.
- The signal cable is not fastened securely.
- Check the computer power and graphics adapter configuration.

The image on the SCREEN is not centered, or too small, or not a rectangle shape.

- Image adjustment has not been done yet in the current operating mode.
Use the OSD, SET and $\Delta \nabla / \triangleleft \triangleright$ buttons to set the image to your liking.

The monitor doesn't enter the power saving off mode (Amber).

- Computer video signal is not VESA DPMS standard. Either the PC or the video controller card is not using the VESA DPMS power management function.

An abnormal picture is displayed on the screen. For example, the upper part of the picture may be missing or dark.

- If using certain non-VESA Standard video card, an abnormal picture may be displayed. Try setting it to one of the factory preset modes, or selecting to a resolution and refresh rate within the specification limits of the monitor.

NOTE

- If the power indicator(LED) light is blinking amber, may result in abnormal condition of the monitor.
- Then press a power ON/OFF button on the front panel control and call your service technician for more information.



Picture Tube	17 inch (16.0 inches viewable) Perfect Flat Tube	
	90 degree deflection	
	0.24mm Slot pitch	
	W-ARAS(Wide Anti-Reflective Anti-Static) coating	
Sync Input	Horizontal Freq.	30 - 70kHz (Automatic)
	Vertical Freq.	50 - 160Hz (Automatic)
	Input Form	Separate, TTL, Positive/Negative
	Signal Input	15 pin D-Sub Connector
Video Input	Input Form	Separate, RGB Analog, 0.7Vp-p/75 ohm, Positive
	Resolution(max)	1280 x 1024@60Hz
Power Consumption	Normal	≤ 74W
	Stand-by/Suspend	≤ 15W
	Power Off	≤ 3W
Dimensions	Width	41.5 cm / 16.3 inches
	Height	43.5 cm / 17.1 inches
	Depth	43.9 cm / 17.3 inches
Power Supply	AC 100-240V 50/60Hz 2.0A	
	Net	17.8 kg (39.24 lbs)
Operating Condition	Temperature	10 °C to 40 °C
	Humidity	10 % to 90 % non-Condensing
Storage Condition	Temperature	0 °C to 60 °C
	Humidity	5 % to 90 % non-Condensing

