

## Introduction

**Thank you for purchasing a high resolution monitor. It will give you high resolution performance and convenient reliable operation in a variety of video operating modes.**

ENGLISH

### Features

- The monitor is a 19 inches (18.0 inches viewable ) intelligent, microprocessor based monitor compatible with most analog RGB (Red, Green, Blue) display standards, including IBM PC®, PS/2®, Apple®, Macintosh®, Centris®, Quadra®, and Macintosh II family.
- The monitor provides crisp text and vivid color graphics with VGA, SVGA, XGA, and VESA Ergonomic modes (non-interlaced), and most Macintosh compatible color video cards when used with the appropriate adaptor. The monitor's wide compatibility makes it possible to upgrade video cards or software without purchasing a new monitor.
- Digitally controlled auto-scanning is done with the micro-processor for horizontal scan frequencies between 30 and 96kHz, and vertical scan frequencies between 50-160Hz.
- This monitor is capable of producing a maximum horizontal resolution of 1600 dots and a maximum vertical resolution of 1200 lines.
- The microprocessor-based digital controls allow you to adjust conveniently a variety of image controls by using the OSD (On Screen Display).
- USB (Universal Serial Bus) ports at the back of the monitor are prepared for the USB cable and hub. You can easily and flexibly connect USB-designed devices- such as a mouse, keyboard or printer- to the monitor for true Plug and Play function.
- Plug and play capability if supported by your system
- This monitor has DDC 1 and DDC 2B function.\*
- Compliant with the following regulated specifications :\*
  - EPA ENERGY STAR
  - Swedish MPR II
  - Swedish TCO'99

*\* For detailed information, please refer to the **Reference** provided .*

- Turn off the equipment and all attached options.
- Carefully set the monitor face-down with the underside facing you.

## Installation

1. Align the hooks on the tilt/swivel stand with the matching slots in the base of the monitor.
2. Insert the hooks into slots.
3. Slide the tilt/swivel stand toward the front of the monitor until the latches click into the locked position.

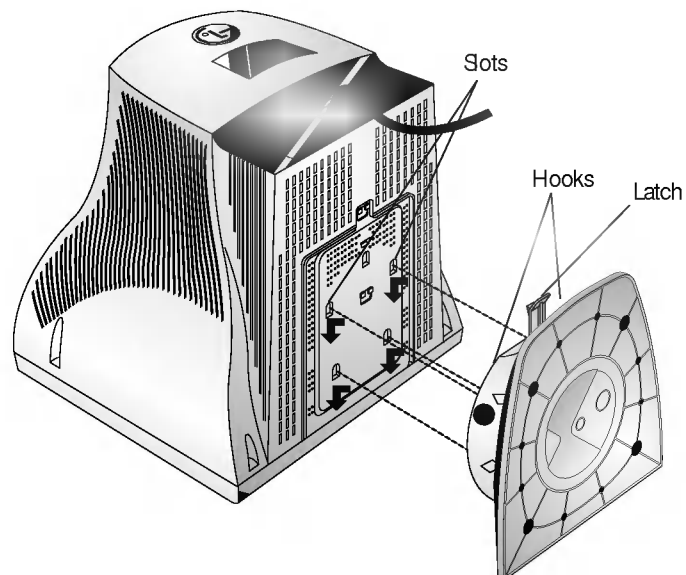

**On the back of the monitor are two plug-in connections; one for the AC power cord, and the other for the signal cable from the video card.**

- Power off both the monitor and PC.
- Connect the 15 pin VGA connector of the supplied signal cable to the output VGA video connector on the PC. The connectors will mate only one way. If you cannot attach the cable easily, turn the connector upside down and try again. When mated, tighten the thumbscrews to secure the connection.
- Locate the appropriate MAC to VGA adapter block at your local computer store. This adapter changes the high density 3 row 15 pin VGA connector to the correct 15 pin 2 row connection to mate with your MAC. Attach the other end of the signal cable to the side of the adapter block with 3 rows.

Connect the attached adapter block/signal cable to the video output on your MAC.

- One end of the AC power cord is connected into the AC power connector on the back of the monitor. The other end is plugged into a properly grounded three-prong AC outlet.
- Power ON the PC, then the monitor.
- If you see the SELF DIAGNOSTICS message, check the signal cable and connectors.
- After using the system, power OFF the monitor, then the PC.

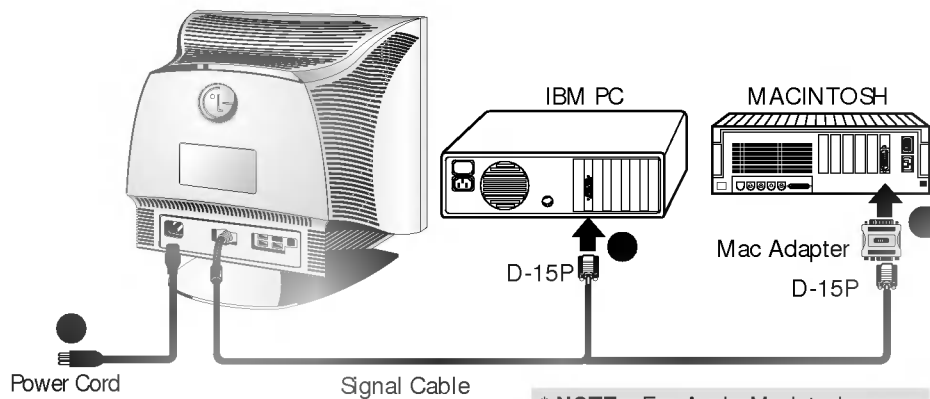

**\* NOTE :** For Apple Macintosh use, a separate plug adapter is needed to change the 15 pin high density (3 row) D-sub VGA connector on the supplied cable to a 15 pin 2 row connector.

USB (Universal Serial Bus) is an innovation in connecting your different desktop peripherals conveniently to your computer. By using the USB, you will be able to connect your mouse, keyboard, printer, and other peripherals to your monitor instead of having to connect them to your computer. This will give you greater flexibility in setting up your system. USB allows you to connect chain up to 120 devices on a single USB port, and you can “hot” plug (attach them while the computer is running) or unplug them while maintaining Plug and Play auto detection and configuration. This monitor has an integrated self-powered USB hub, allowing up to 4 other USB devices to be attached it.

### USB connection

1. Connect the upstream port of the monitor to the downstream port of the USB compliant PC or another hub using the USB cable (Computer must have a USB port).
2. Connect the USB compliant peripherals to the downstream ports of the monitor.

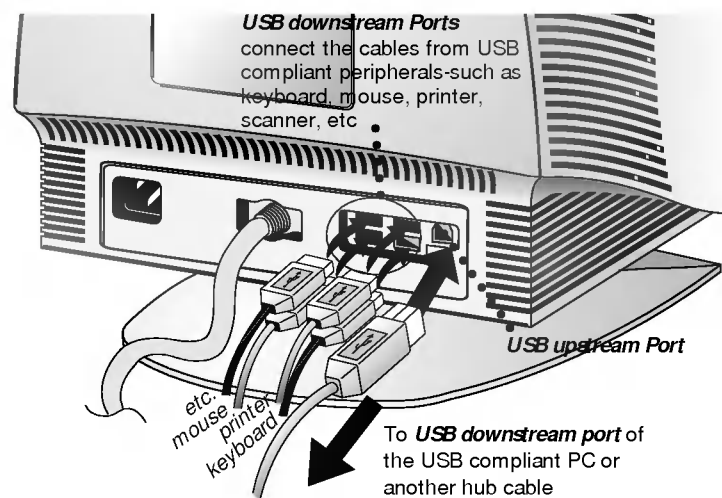

#### NOTE

- To activate the USB hub function, the monitor must be connected to a USB compliant PC(OS) or another hub with the USB cable(enclosed).
- When connecting the USB cable, check that the shape of the connector at the cable side matches the shape at the connecting side.
- When the monitor is not plugged into an electric socket, the peripherals connected to the downstream ports will not operate.
- Even if the monitor is in a power saving mode, USB compliant devices will function when they are connected the USB ports(both the upstream and downstream) of the monitor.

## Front View

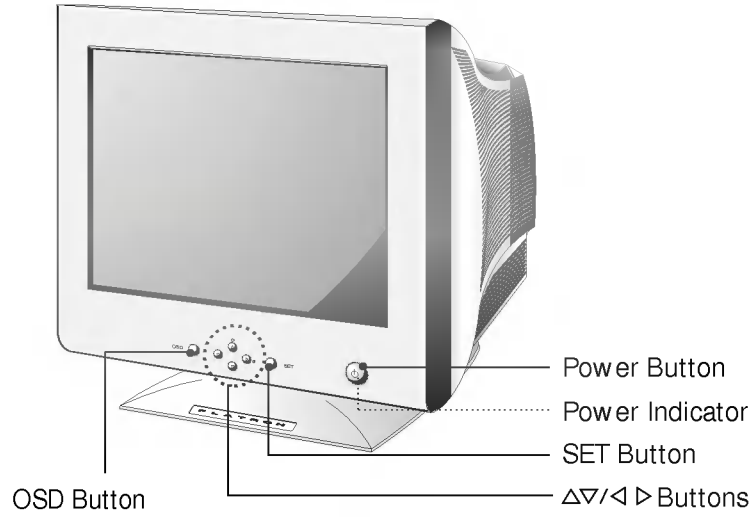

## Rear View

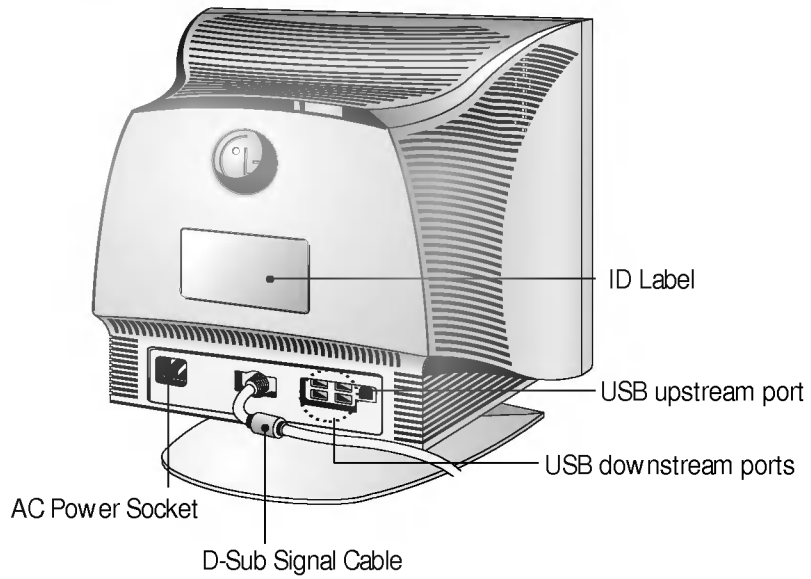



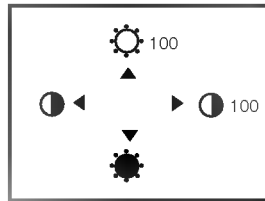
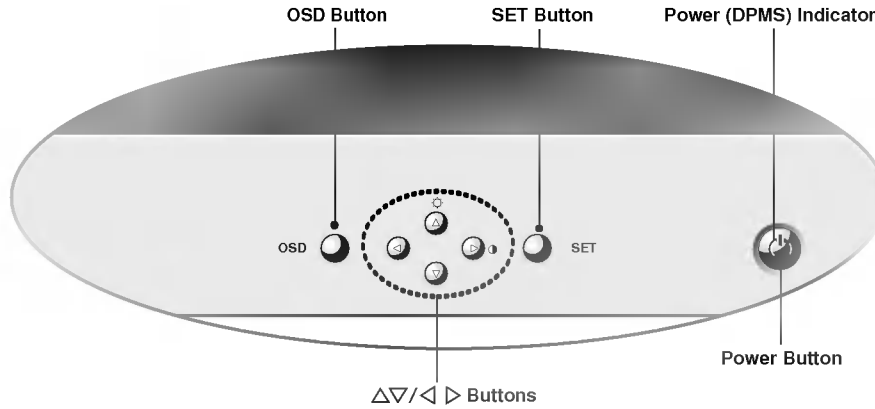

## Front Panel Controls



### <Shortcut Keys>

- Brightness and Contrast can be adjusted directly without entering the On Screen Display (OSD) system. Press the  $\Delta/\nabla$  buttons to display the menu and then the  $\nabla/\Delta/\leftarrow/\rightarrow$  buttons to adjust the settings. To save all changes, press the **SET button**. The Brightness and Contrast functions are also available in the On Screen Display (OSD) menu.

Control	Function
 <b>OSD Button</b>	Use this button to enter or exit the on screen display.
 <b><math>\Delta/\nabla/\leftarrow/\rightarrow</math> Buttons</b>	Use these buttons to choose or adjust items in the on screen display.
 <b>SET Button</b>	Use this button to enter a selection in the on screen display.
 <b>Power Button</b>	Use this button to turn the monitor on or off.
<b>Power (DPMS) Indicator</b>	The power indicator light is shown in the power button. This Indicator lights up green when the monitor operates normally. If the monitor is in DPM (Energy Saving) mode (stand-by/suspend/off), this indicator color changes to amber.

Making adjustments to the image size, position and operating parameters of the monitor are quick and easy with the On Screen Display Control system. A quick example is given below to familiarize you with the use of the controls. Following section is an outline of the available adjustments and selections you can make using the OSD.

**NOTE**

- Allow the monitor to stabilize for at least 30 minutes before making image adjustment.



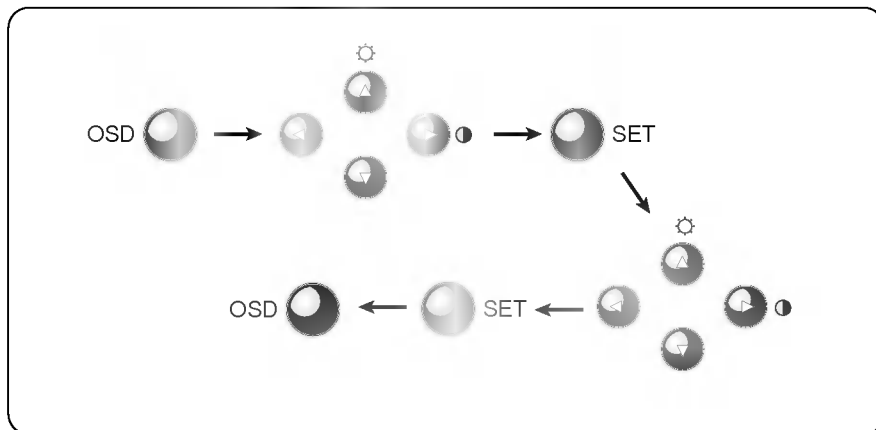



To make adjustments in the On Screen Display, follow these steps:

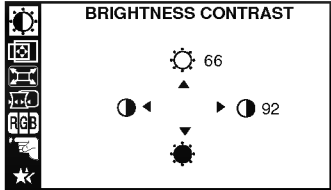

- 1** Press the OSD Button, then the main menu of the OSD appears.
- 2** To access a control, use the  $\Delta$  or  $\nabla$  Buttons. When the icon you want becomes highlighted, press the SET Button.
- 3** Use the  $\Delta/\nabla/\leftarrow/\rightarrow$  Buttons to adjust the item to the desired level.
- 4** Accept the changes by pressing the SET Button.
- 5** Exit the OSD by Pressing the OSD Button.

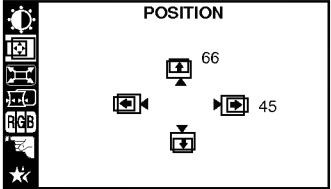
## On Screen Display(OSD) Selection and Adjustment

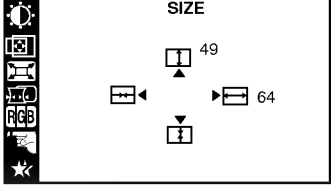
You were introduced to the procedure of selection and adjusting an item using the OSD system. Listed below are the icons, icon names, and icon descriptions of the items that are shown on the Menu.

OSD Adjust	Description
	<p> <b>Brightness</b> Used to adjust the brightness of the screen.</p> <p> <b>Contrast</b> Adjust the display to the contrast desired.</p>
	<p> <b>Vertical Position</b> To move image up and down.</p> <p> <b>Horizontal Position</b> To move picture image left and right.</p>
	<p> <b>Vertical Size</b> To adjust image height.</p> <p> <b>Horizontal Size</b> To adjust image width.</p>



# On Screen Display(OSD) Selection and Adjustment

OSD Adjust	Description
------------	-------------

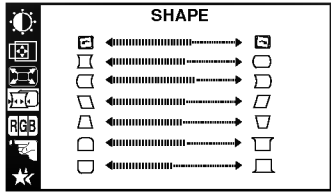

- Tilt**  
To correct image rotation.
- Side Pincushion**  
To correct the bowing in and out of the image.
- Side pincushion balance**  
To correct the balance of both sides bowing.
- Parallelogram**  
This control adjusts for a skewing of the screen image.
- Trapezoid**  
To correct geometric distortion.
- Top Corner**  
To correct the irregular distortion of the displayed image.
- Bottom Corner**  
To correct the irregular distortion of the displayed image.

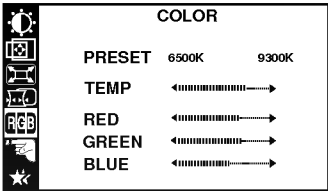

- PRESET 6500K/ 9300K**  
To appear the displays color temperature.
  - 6500K:Slightly reddish white.
  - 9300K:Slightly bluish white.
- TEMP**  
User easily color set without adjustment Red, Green and Blue (R/G/B).
- RED**  
**GREEN**  
**BLUE**  
 To set your own color levels.

## On Screen Display(OSD) Selection and Adjustment

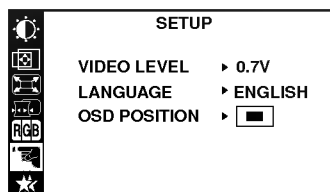

**VIDEO LEVEL** This item is used to select the monitor's input signal level. The normal level used for most PC's is 0.7V.

When the screen suddenly gets brightened or blurry, please select 1.0V and try again.

**LANGUAGE** To choose the language in which the control names are displayed.

OSD Menus are available in 11 languages: English, German, French, Spanish, Italian, Swedish, Finnish, Portuguese, Korean, Chinese and Russian.

**OSD POSITION** To adjust position of the OSD window on the screen.

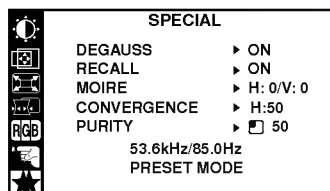

**DEGAUSS** To manually demagnetize the screen which may show some image or color incorrectly.

**RECALL** You can use this function when you want to go back to the screen display of the time you purchased the product after adjusting to modify it in the Preset Mode.

When you are in the User mode, you can recall only , , , , ,  and CONVERGENCE items. After using Recall, adjust the screen display again if necessary. If you want more information on the Preset Mode, refer to A11 page.

**MOIRE** This item allows you to reduce the moire (Moire is caused by interference Horizontal Scan Line with the periodical dot screen). It is normally OFF(H:0/V:0).

The moire adjustments may affect the focus of the screen.

The screen image may shake slightly while the moire reduction function is on.

**CONVERGENCE** This item allows you to adjust the horizontal convergence.

The horizontal convergence control adjust the alignment of the red and blue horizontal fields.

**PURITY** Use to adjust the purity on the screen if the color appears uneven.

- (1)  Adjust the purity of the upper left corner of the screen.
- (2)  Adjust the purity of the upper right corner of the screen.
- (3)  Adjust the purity of the lower left corner of the screen.
- (4)  Adjust the purity of the lower right corner of the screen.

## Video Memory Modes

The monitor has 20 memory locations for display modes, 5 of which are factory preset to popular video modes.

### Preset Modes (Resolution)

	Display Modes (Resolution)	Horizontal Freq. (kHz)	Vertical Freq. (Hz)
1	VESA 640 x 480	43.269	85
2	VESA 800 x 600	53.674	85
3	VESA 1024 x 768	68.677	85
4	VESA 1280 x 1024	91.146	85
5	VESA 1600 x 1200	93.750	75

### User Modes

- Modes 6-20 are empty and can accept new video data. If the monitor detects a new video mode that has not been present before or is not one of the preset modes, it stores the new mode automatically in one of the empty modes starting with mode 6.

If you use up the 15 blank modes and still have more new video modes, the monitor replaces the information in the user modes starting with mode 6.

### Recalling Display Modes

- When your monitor detects a mode it has seen before, it automatically recalls the image settings you may have made the last time you used that mode.

You may, however, manually force a recall of each of the 5 preset modes by pressing the Recall button. All preset modes are automatically recalled as the monitor senses the incoming signal.

The ability to recall the preset modes is dependent on the signal coming from your PC's video card or system. If this signal does not match any of the factory modes, the monitor automatically sets itself to display the image.

## Troubleshooting

### **Check the following before calling for service.**

#### **SELF DIAGNOSTICS message.**

- The signal cable is not connected, or is loose. Check and secure the connection.

#### **OUT OF FREQUENCY message appears.**

- The frequency of the sync input is outside the operating range of the monitor.

\* Horizontal Frequency : 30-96kHz

\* Vertical Frequency : 50-160Hz

Use the graphics board's utility software to change the frequency setting (Refer to the manual for graphics board).

#### **The power LED is illuminated amber.**

- Display power management mode.
- There is no sync signal and the signal cable is not fastened securely.
- Check the computer power and graphics adapter configuration.

#### **The image on the SCREEN is not centered, or too small, or not a rectangle shape.**

- Image adjustment not been done yet in the current operating mode. Use the OSD, SET and  $\Delta \nabla / \triangleleft \triangleright$  buttons to set the image to your liking.

#### **The monitor doesn't enter the power saving off mode (Amber).**

- Computer video signal is not VESA DPMS standard. Either the PC or the video controller card is not using the VESA DPMS power management function.

<b>Picture Tube</b>	19 inch (18.0 inches viewable) Perfect Flat Tube	
	90 degree deflection	
	0.24mm Slot pitch	
	ARAS(Anti-Reflective Anti-Static) coating	
<b>Sync Input</b>	Horizontal Freq.	30 - 96kHz (Automatic)
	Vertical Freq.	50 - 160Hz (Automatic)
	Input Form	Separate TTL, Positive/Negative Composite TTL, Positive/Negative
	Signal Input	15 pin D-Sub Connector
<b>Video Input</b>	Input Form	Separate, RGB Analog, 0.7Vp-p/75 ohm, Positive
	Resolution(max)	1600 x 1200@75Hz
<b>USB specifications</b>	USB standard	Rev. 1.1 complied self-powered hub
	Downstream power supply	500mA for each (MAX)
	Communication speed	12 Mbps (full), 1.5 Mbps (low)
	USB port	1 Upstream port 4 Downstream ports
<b>Power Consumption</b>	Max.	≤ 120W (140W)
	Normal	≤ 90W (100W)
	Stand-by/Suspend	≤ 8W (30W)
	Power Off	≤ 3W (20W) * ( ): with USB
<b>Dimensions (with tilt/swivel stand)</b>	Width	47.0 cm / 18.5inches
	Height	48.0 cm / 18.9inches
	Depth	47.0 cm / 18.5 inches
<b>Power Input</b>	Europe	AC 200-240V 50Hz 1.0A
	Others	AC 100-240V 50/60Hz 2.0A
The products should be used according to the Power requirements of each ID LABEL.		
	Net	25.7kg (56.2lbs)
Operating Condition		
	Temperature	0 °C to 40 °C
	Humidity	10 % to 90 % non-Condensing
Storage Condition		
	Temperature	-20 °C to 60 °C
	Humidity	5 % to 90 % non-Condensing