



ENGLISH

MINI HI-FI AUDIO SYSTEM

OWNER'S MANUAL

**MODELS : FFH-877A/L/S/AX/AD
FE-877E
FFH-977A/L/S/AX/AD
FE-977E**

Please read this manual carefully before operating your unit.
Retain it for future reference.

**Designs and specifications are subject to change
without notice for improvement.**



	CAUTION RISK OF ELECTRIC SHOCK DO NOT OPEN	
CAUTION: TO REDUCE THE RISK OF ELECTRIC SHOCK DO NOT REMOVE COVER(OR BACK). NO USER SERVICEABLE PARTS INSIDE. REFER SERVICING TO QUALIFIED SERVICE PERSONNEL.		

Explanation Graphical Symbols:



The lightning flash with arrowhead symbol, within an equilateral triangle is intended to alert the user to the presence of uninsulated dangerous voltage within the product's enclosure that may be of sufficient magnitude to constitute a risk of electric shock to persons.



The exclamation point within an equilateral triangle is intended to alert the user to the presence of important operating and maintenance (servicing) instructions in the literature accompanying the appliance.

WARNING:

TO REDUCE THE RISK OF FIRE OF ELECTRIC SHOCK, DO NOT EXPOSE THIS APPLIANCE TO RAIN OR MOISTURE.

To avoid electrical shock, do not open the cabinet. Refer servicing to qualified personnel only.

CAUTION Use of controls or adjustments or performance of procedures other than those specified herein may result in hazardous radiation exposure.

The apparatus shall not be exposed to dripping or splashing and that no objects filled with liquids, such as vases, shall be placed on the apparatus.

(FOR THE CUSTOMERS IN EUROPE)

If this product is marked with the CE-symbol, it means which is conformed to EMC regulation 89/336/EEC.

Laser component in this product is capable of emitting radiation exceeding the limit for Class 1.

CAUTION: INVISIBLE LASER RADIATION WHEN OPEN AND INTERLOCKS DEFEATED. AVOID EXPOSURE TO BEAM.
WARNING: OSYNLIG LASERSTRÅLNING NÅR DENNA DEL ÄR ÖPPNAD STRÅLEN ÄR FARLIG.
ATTENTION: Quand l'appareil est ouvert, ne pas s'exposer aux radiations invisibles du faisceau laser.

This label is located on the interior.

<table style="width: 100%; border-collapse: collapse;"> <tr><td>CLASS 1</td><td>LASER PRODUCT</td></tr> <tr><td>KLASSE 1</td><td>LASER PRODUKT</td></tr> <tr><td>LUOKAN 1</td><td>LASER LAITE</td></tr> <tr><td>KLASS 1</td><td>LASER APPARAT</td></tr> <tr><td>CLASSE 1</td><td>PRODUIT LASER</td></tr> </table>	CLASS 1	LASER PRODUCT	KLASSE 1	LASER PRODUKT	LUOKAN 1	LASER LAITE	KLASS 1	LASER APPARAT	CLASSE 1	PRODUIT LASER	This Compact Disc player is classified as a CLASS 1 LASER product. The CLASS 1 LASER PRODUCT label is located on the exterior.
CLASS 1	LASER PRODUCT										
KLASSE 1	LASER PRODUKT										
LUOKAN 1	LASER LAITE										
KLASS 1	LASER APPARAT										
CLASSE 1	PRODUIT LASER										

(FOR CUSTOMERS IN CANADA)

CAUTION: TO PREVENT ELECTRIC SHOCK, DO NOT USE THIS (POLARIZED) PLUG WITH AN EXTENSION CORD, RECEPTACLE, OR OTHER OUTLET UNLESS THE BLADES CAN BE FULLY INSERTED TO PREVENT BLADE EXPOSURE.

This class B digital apparatus meets all requirements of the Canadian Interference-Causing Equipment Regulations.

WARNING:

SHOCK HAZARD - DO NOT OPEN

MISE EN GARDE:

Pour éviter les chocs électriques, n'utilisez pas cette fiche (polarisée) avec une rallonge, un réceptacle ou une autre prise si vous ne pouvez pas y insérer les broches à fond.

MISE EN GARDE

Cet appareil numérique de la classe B respecte toutes les exigences de Règlement sur le matériel brouilleur de Canada.

AVERTISSEMENT

RISQUE DE CHOC ELECTRIQUE-NE PAS OUVRIR (FOR CUSTOMERS IN THE UNITED STATES OF AMERICA)

Note to CATV system Installer: This reminder is provided to call the CATV system installer's attention to Article 820-40 of the NEC that provides guidelines for proper grounding and, in particular, specifies that the cable ground shall be connected to the grounding system of the building, as close to the point of cable entry as practical.
--

NOTE:

The interference potential to the device.

This equipment generates and uses radio frequency energy and if not installed and used properly, that is in strict accordance with the manufacturer's instructions, may cause interference to radio and television reception. It has been type tested and found to comply with the limits for a Class B computing device in accordance with the specifications in subparts J of Part 15 of FCC Rules, which are designed to provide reasonable protection against such interference in a residential installation. However, there is no guarantee that interference will not occur in a particular installation. If this equipment does cause interference to radio or television reception, which can be determined by turning the equipment off and on, the user is encouraged to try to correct the interference by one of more of the following measures:

- Reorients or relocate the receiving antenna.
- Increase the separation between the equipment and receiver.
- Connect the equipment into an outlet on a circuit different from that to which the receiver is connected.
- Consult the dealer or an experienced radio/TV technician for help.

(FOR CUSTOMERS IN THE UNITED KINGDOM)

WIRING INSTRUCTIONS

This appliance is supplied with a BS1363 approved 3 amp fused mains plug. When replacing the fuse always use a 3 amp BS1362 approved type. Never use this plug with the fuse cover omitted. To obtain a replacement fuse cover contact your supplying dealer or 'ILG ELECTRONICS U.K. LTD'.

If the mains sockets in your home differ, or are not suitable for the type of plug supplied, then the plug should be removed and a suitable type fitted. Please refer to the wiring instructions below:

Warning :

The mains plug severed from the mains lead of this appliance must be destroyed. A mains plug with bared wires is hazardous if engaged in a mains output line socket.

IMPORTANT

The wires in this mains lead are coloured in accordance with the following codes:

Blue	:	Neutral
Brown	:	Live

As the colour of the wires in the mains lead of this appliance may not correspond with the coloured markings identifying the terminals in your plug, proceed as follows:

The wire which is coloured blue must be connected to the terminal which is marked with the letter N or coloured black.

The wire which is coloured brown must be connected to the terminal which is marked with the letter L or coloured red.

If a 13 amp BS1363 plug or any other type of plug is used, 3 amp BS1362 approved fuse must be fitted either in the plug or at the distribution board.

Warning :

Do not connect either wire to the earth pin, marked with the letter E or with the earth symbol \equiv or coloured green or green and yellow.

A note about your operating voltage

Before connecting the unit to an AC outlet, check that the operating voltage of the unit is identical with the voltage of your local power supply. And if your unit is equipped with the Voltage Selector on the back of the unit, set to it your required voltage.

IMPORTANT SAFETY INSTRUCTIONS



FOR CUSTOMERS IN THE UNITED STATES

CAUTION:

- Read all of these instructions.
- Save these instructions for later use.
- Follow all warnings and instructions marked on the audio equipment.

- Read instructions - All the safety and operating instructions should be read before the product is operated.
- Retain instructions - The safety and operating instructions should be retained for future reference.
- Heed Warnings - All warnings on the product and in the operating instructions should be followed.
- Follow instructions - All operating and use instructions should be followed.
- Cleaning - Unplug this product from the wall outlet before cleaning. Do not use liquid cleaners or aerosol cleaners. Use a damp cloth for cleaning.
- Attachments - Do not use attachments not recommended by the product manufacturer as they may cause hazards.
- Water and Moisture - Do not use this product near water-for example, near a bath tub, wash bowl, kitchen sink, or laundry tub; in a wet basement; or near a swimming pool;
- Accessories - Do not place this product on an unstable cart, stand, tripod, bracket, or table. The product may fall, causing serious injury to a child or adult, and serious damage to the product. Use only with a stand, tripod, bracket, or table recommended by the manufacturer or sold with the product. Any mounting of the product should follow the manufacturer's instructions and should use a mounting accessory recommended by the manufacturer.
- A product and cart combination should be moved with care. Quick stops, excessive force, and uneven surfaces may cause the product and cart combination to overturn.
- Ventilation - Slots and openings in the cabinet are provided for ventilation and to ensure reliable operation of the product and to protect it from overheating, and these openings must not be blocked or covered. The openings should never be blocked by placing the product on a bed, sofa, rug, or other similar surface. This product should not be placed in a built-in installation such as a bookcase or rack unless proper ventilation is provided or the manufacturer's instructions have been followed.
- Power Sources - This product should be operated only from the type of power source indicated on the marking label. If you are not sure of the type of power supply to your home, consult your product dealer or local power company. For products intended to operate from battery power, or other sources, refer to the operating instructions.
- Power-Cord Protection - Power supply cords should be routed so that they are not likely to be walked on or pinched by items placed upon or against them, paying particular attention to cords at plugs, convenience receptacles, and the point where they exit from the product.
- Protective Attachment Plug - The product is equipped with an attachment plug having overload protection. This is a safety feature. See Instruction Manual for replacement or resetting or protective device. If replacement of the plug is required, be sure the service technician has used a replacement plug specified by the manufacturer that has the same overload protection as the original plug.
- Lightning - For added protection for this product during a lightning storm, or when it is left unattended and unused for long periods of time, unplug it from the wall outlet and disconnect the antenna or cable system. This will prevent damage to the product due to lightning and power-line surges.



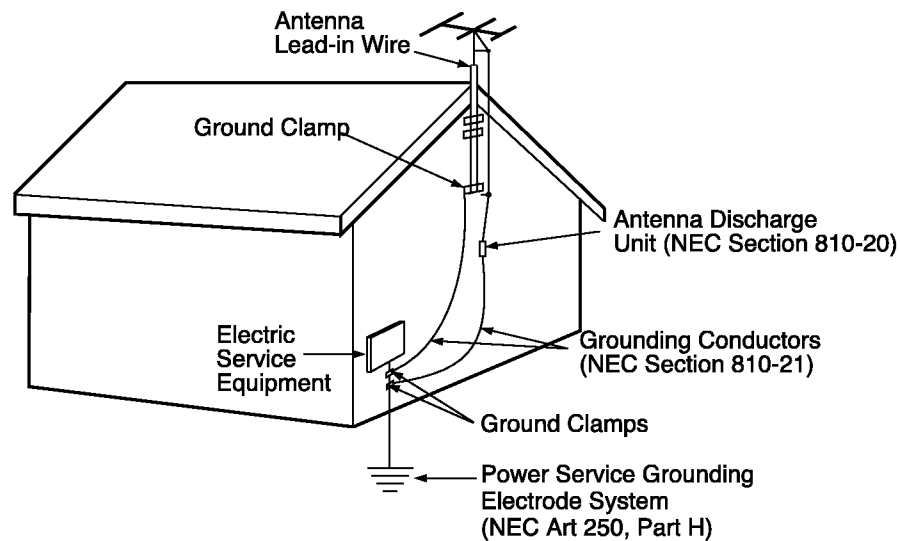

- Outdoor Antenna Grounding - If an outside antenna or cable system is connected to the product, be sure the antenna or cable system is grounded so as to provide some protection against voltage surges and built-up static charges.
- Article 810 of the National Electrical Code, ANSI/NFPA 70 provides information with regard to proper grounding of the mast and supporting structure, grounding of the lead-in wire to an antenna discharge unit, size of grounding conductors, location of antenna discharge unit, connection to grounding electrodes, and requirements for the grounding electrode.
- Power Lines - An outside antenna system should not be located in the vicinity of overhead power lines or other electric light or power circuits, or where it can fall into such power lines or circuits. When installing an outside antenna system, extreme care should be taken not to touch such power lines or circuits as contact with them might be fatal.
- Overloading - Do not overload wall outlets, extension cords, or integral convenience receptacles, as this can result in a risk of fire or electric shock.
- Object and Liquid Entry - Never push objects of any kind into this product through openings as they may touch dangerous voltage points or short-out parts that could result in a fire or electric shock. Never spill liquid of any kind on the product.
- Servicing - Do not attempt to service this product yourself as opening or removing covers may expose you to dangerous voltage or other hazards. Refer all servicing to qualified service personnel.
- Damage Requiring Service - Unplug this product from the wall outlet and refer servicing to qualified service personnel under the following conditions:
 - a) When the power-supply cord or plug is damaged.
 - b) If liquid has been spilled, or objects have fallen into the product.
 - c) If the product has been exposed to rain or water.
 - d) If the product does not operate normally by following the operating instructions. Adjust only those controls that are covered by the operating instructions as an improper adjustment of other controls may result in damage and will often require extensive work by a qualified technician to restore the product to its normal operation.
 - e) If the product has been dropped or damaged in any way.
 - f) When the product exhibits a distinct change in performance, this indicates a need for service.
- Replacement Parts - When replacement parts are required, be sure the service technician has used replacement parts specified by the manufacturer or have the same characteristics as the original parts. Unauthorized substitutions may result in fire, electric shock, or other hazards.
- Safety Check - Upon completion of any service or repairs to this product, ask the service technician to perform safety checks to determine that the product is in proper operating condition.
- Wall or Ceiling Mounting - The product should be mounted to a wall or ceiling only as recommended by the manufacturer.
- Heat - The product should be situated away from heat sources such as radiators, heat registers, stoves, or other products (including amplifiers) that produce heat.

OPERATING ELEMENTS

FRONT VIEW

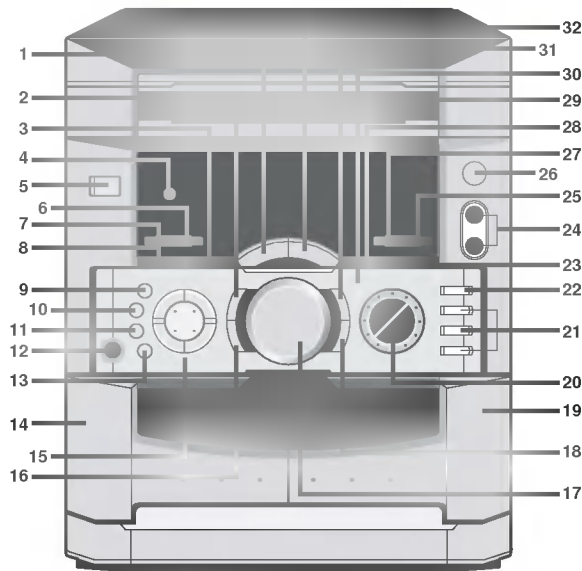

FRONT VIEW

1. PRESET DOWN button
BACKWARD PLAY button (OPTIONAL) button
(PRESET DOWN / ◀)
2. MDSS button
3. AUTO TUNING DOWN(TUNER: OPTIONAL),
TAPE REWIND, TRACK BACKWARD,
SKIP/SEARCH(CD) button(◀◀◀◀)
4. REMOTE SENSOR
5. POWER button
6. TIMER button
7. CLOCK button
8. RECORD / RECORD PAUSE button(●REC/||)
9. FM MODE / RIF button
10. DEMO/PLAY MODE Button
COUNTER RESET button (OPTIONAL)
11. NORMAL DUBBING button
CD SYNCHRO RECORDING button
12. HEADPHONE socket (PHONES)
13. HI-SPEED DUBBING button
14. TAPE DECK 1 EJECT position (▲PUSH EJECT)
15. FUNCTION SELECT button [FM, MW(AM),
LW/SW (OPTIONAL), CD, TAPE 1/2, AUX]
16. EQ. PATTERN button
17. VOLUME knob
18. DIMMER / POWER SAVING button(OPTIONAL)
19. TAPE DECK 2 EJECT position (▲PUSH EJECT)
20. JOG DIAL(OPTIONAL)
 - MANUAL TUNING DOWN/UP (TUNER)
 - ADJUST DOWN/UP (CLOCK/TIMER)
 - SKIP DOWN/UP (CD TRACK)

REAR VIEW

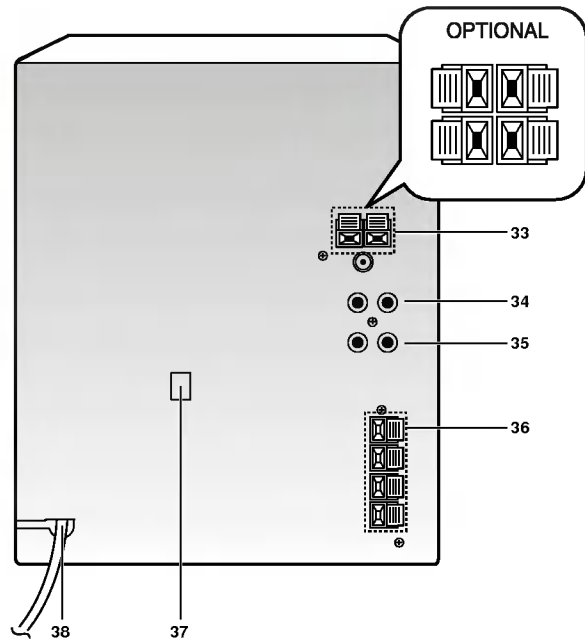

21. DISC DIRECT PLAY buttons
(DISC1, DISC2, DISC3)
22. DISC SKIP button
23. TAPE STOP, CD STOP / CLEAR button
(■/CLEAR)
24. MIC jacks (MIC1 / MIC2): OPTIONAL
25. CD OPEN / CLOSE (CD ▲) button
26. MIC VOLUME: OPTIONAL
27. PROGRAM / MEMORY button
28. AUTO TUNING UP button (TUNER: OPTIONAL)
TAPE FAST FORWARD, TRACK FORWARD,
SKIP/SEARCH (CD) button (▶▶▶▶)
29. CD DOOR
30. CD PAUSE / SET indicator
31. CD PAUSE / SET(CLOCK / TIMER) button
COUNTER RESET (TAPE) button (CD || / SET /
COUNTER RESET) / RDS (TUNER) button :
OPTIONAL
32. PRESET UP(TUNER) / FORWARD PLAY(TAPE)
/ CD PLAY button (PRESET UP / ▶)

REAR VIEW

33. ANTENNA (AERIAL) terminal
34. AUXILIARY INPUT sockets
35. MAIN SPEAKER OUTPUT sockets (Option for
the model FFH-977)(HIGH FREQUENCY)
36. SPEAKER terminal
Used to the Main Speaker terminal for the model
FFH-877, or used to the Super Woofer(Speaker)
terminal for the model FFH-977(LOW
FREQUENCY)
37. VOLTAGE SELECTOR (OPTIONAL)
38. POWER CORD

FUNCTION DISPLAY

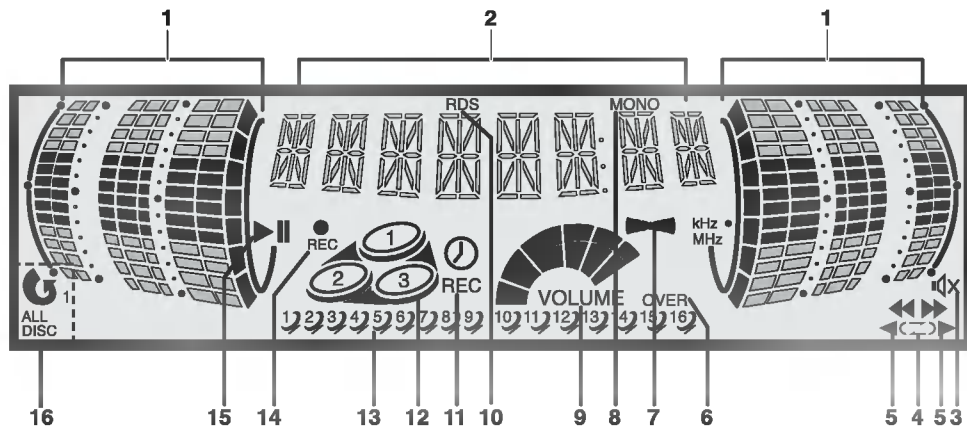

- | | |
|--|---------------------------------------|
| 1. LEVEL indicator | 8. FM MONO indicator |
| 2. FUNCTION, VOLUME LEVEL, CLOCK, FREQUENCY, TAPE COUNTER, CD PLAYING TIME display | 9. VOLUME indicator |
| 3. MUTE indicator | 10. RDS function indicator (OPTIONAL) |
| 4. PLAY MODE indicator
(Use only auto reverse deck) | 11. TIMER indicator |
| 5. TAPE DIRECTION indicator | 12. DISC NO. indicator |
| 6. CD MUSIC CALENDAR OVER indicator | 13. CD MUSIC CALENDAR |
| 7. FM STEREO indicator | 14. RECORD/ RECORD PAUSE indicator |
| | 15. PLAY / PAUSE indicator |
| | 16. CD REPEAT indicator |

REMOTE CONTROL

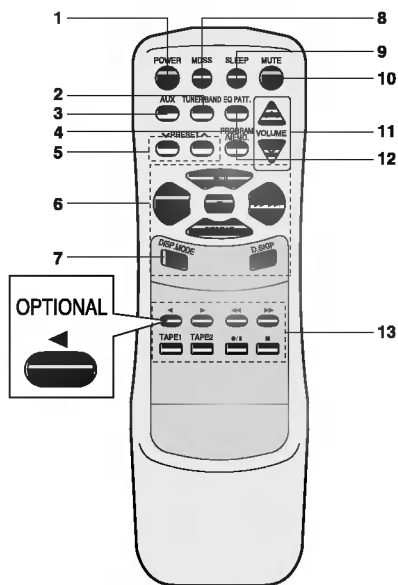

- | |
|--|
| 1. POWER button |
| 2. TUNER / BAND button |
| 3. AUX button |
| 4. EQ PATTERN button |
| 5. PRESET DOWN/UP (V / ^) button |
| 6. CD FUNCTIONS |
| • DISC SKIP (D.SKIP) button |
| • PLAY/PAUSE (▶/) button |
| • STOP/CLEAR (■) button |
| • SKIP / SEARCH (◀◀◀/▶▶▶) buttons |
| • REPEAT button |
| 7. DISPLAY MODE button |
| 8. MDSS button |
| 9. SLEEP button |
| 10. MUTE button |
| 11. VOLUME CONTROL (^ / V) buttons |
| 12. PROGRAM / MEMORY button |
| 13. TAPE FUNCTIONS |
| • TAPE 1 / TAPE 2 button |
| • RECORD / RECORD PAUSE button (●/) |
| • BACKWARD PLAY button (◀) : OPTIONAL |
| • FORWARD PLAY button (▶) |
| • STOP button (■) |
| • REWIND / FAST FORWARD button (◀◀/▶▶) |

REMOTE CONTROL

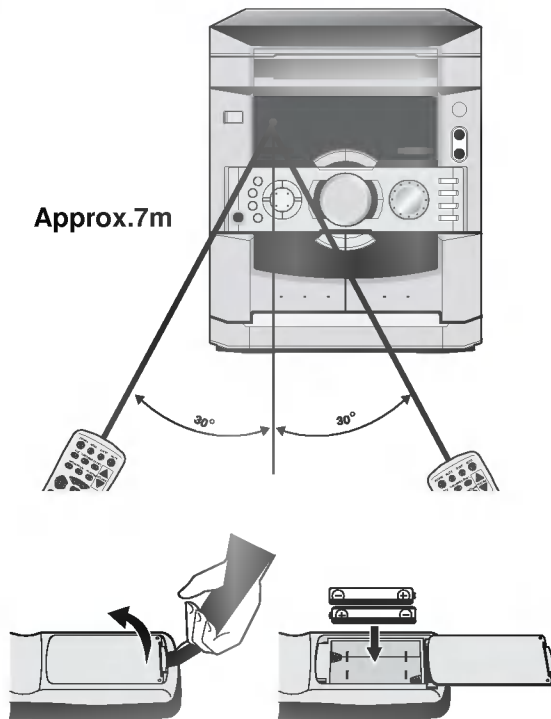

Control Range

The remote control device is designed for the range shown in the illustration.

NOTE :

Strong light or obstacles between the remote control device and the stereo system may interfere with the functioning of the remote control.

Notes on Batteries

- Your remote control comes with batteries. Use two "AAA(UM-4. IEC R03)" type high quality batteries.
- When the remote control fails to operate accurately at maximum distance from the unit. Replace the worn out batteries with new ones.
- Install two "AAA" type batteries, observing correct battery polarity(⊕ and ⊖). Reversed battery polarity might damage the unit.
- Do not use different types of batteries together, or an old one with new one.
- When you are not going to use the unit for a long time, remove the batteries to prevent possible electrolyte leakage.

CONNECTIONS

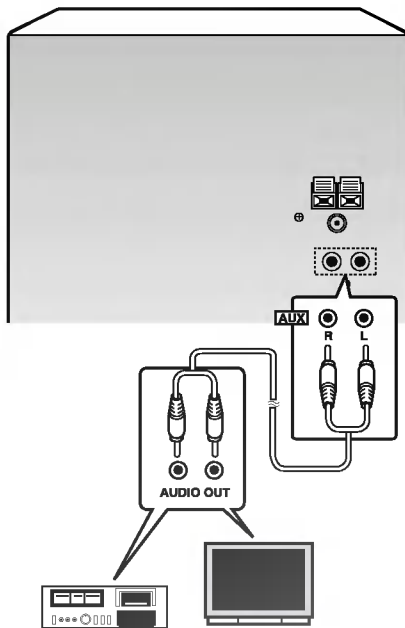

Adjusting the voltage (optional)

If your set is equipped with a voltage selector at the back side, be sure to set it to your local power supplied before connecting the AC power cord.

Connection the AUX

Two phono sockets marked 'AUX' are provided on the rear of the unit for connecting other units. (For example, a record player with a pre amplifier, video recorders or tape recorders.)

Connecting the Loud Speakers

(Option for the model FFH-877)

Insert the red wire of the right/left hand speaker into the red terminal marked(+)

Insert the black wire into the black terminal marked(-).

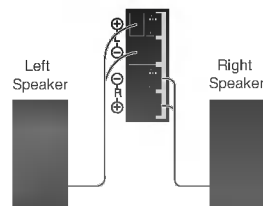

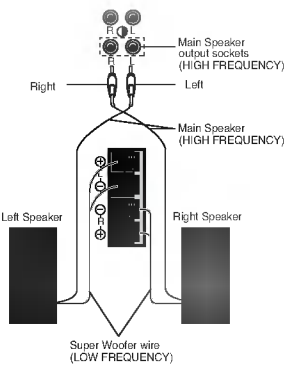

Connection the Loud Speakers

(Option for the model FFH-977 only)

- 1. Connection the Main Speaker Plugs(HIGH FREQUENCY)**
Insert main speaker jack of the rear of the speaker system into the main speaker output sockets at the rear of the unit. Insert the right hand speaker jack into the red socket(R) and insert the left hand speaker jack into the white socket(L).
- 2. Connection the Super Woofer(Speaker) wires(LOW FREQUENCY)**
Insert the red wire of the right/left hand speaker into the red terminal marked(⊕) at the rear of the unit.
Insert the black wire into the black terminal marked (⊖).

Antenna(aerial) Connection

For the models for other countries figure (1), (3).
For the European and U.K. model figure (2), (4).

IMPORTANT

FM Antenna (aerial) Connection

Unless radio signals are very weak, no external antenna is necessary, simply connect the supplied FM indoor antenna (aerial) wire to the terminal marked FM on the back of the unit.

(1) 2 BAND(FM/AM) AREA

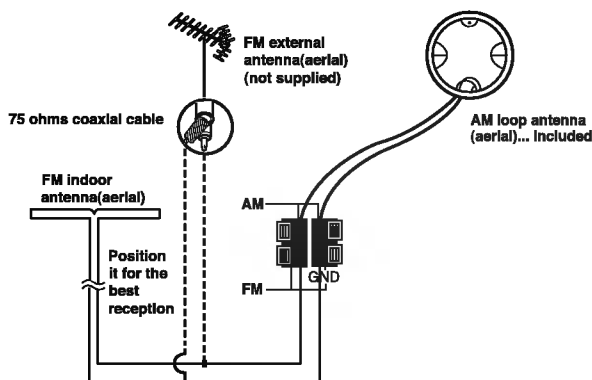

(2) 3 BAND(FM/MW/LW) AREA

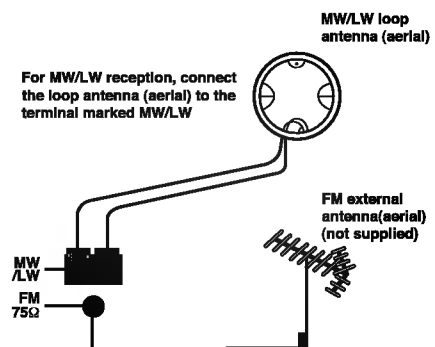

(3) 3 BAND(FM/MW/SW) AREA

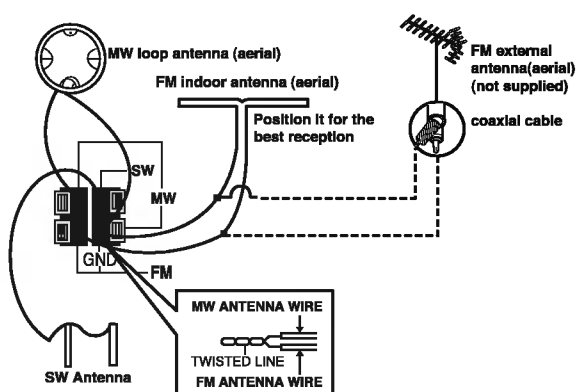

(4) 2 BAND[FM/AM(MW)] AREA

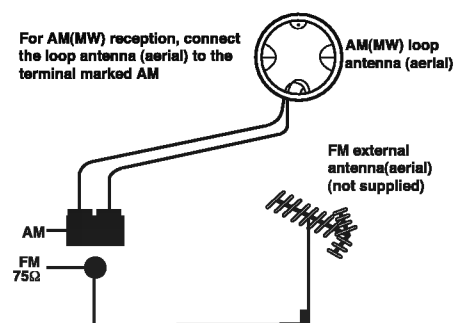

Example : Set to 9:25 in the morning

1. Press the **CLOCK** button.
(If the clock is already set, press and hold the **CLOCK** button for more than 1.5 seconds.)



2. Select a 24 hour cycle or 12 hour cycle by turning the **JOG DIAL**.

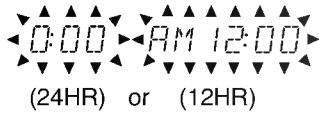

3. Press the **CDII/SET** button.

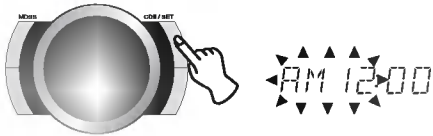

4. Set the hour with **JOG DIAL**.



5. Press the **CDII/SET** button.

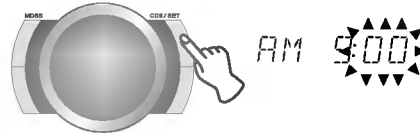

6. Set the minutes with **JOG DIAL**.



7. Press the **CDII/SET** button.
The clock starts operating.

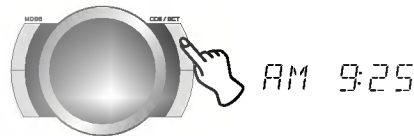

Information on the time

AM 12:00 = midnight

PM 12:00 = noon

NOTE:

When a power interruption has occurred for more than 10 seconds.

The clock setting is erased, and "-- : --" will flash on the display.

BEFORE OPERATING

■ Volume Adjustment

Turn VOLUME clockwise to increase the sound level, or counterclockwise to decrease it.

If you turn the volume up more than the maximum level, the volume level flashes in the display. (Or press VOLUME \wedge or \vee button on the remote commander.)

■ Sound Quality Adjustment

▶ MDSS (Multi Dynamic Sound System)

Press the MDSS button to reinforce treble (Hi-Tone), bass (UBB : Ultra Bass Booster), and surround effect. The MDSS indicator lights up.

To cancel it press the MDSS button again.

▶ To activate stereo sound

You can choose between 4 fixed sound modes : select a desired sound mode by using the EQ PATTERN button.

Press the EQ PATTERN button once to see the current sound mode scrolled on the display.

Press the EQ PATTERN button repeatedly, until the desired sound mode is scrolled on the display.

FLAT : linear frequency response

ROCK : more bass, more treble

POP : less bass, less treble

CLASSIC : for orchestral music

▶ Super Woofer System

(Option for the model FFH-977 only)

Simply by connecting the Super Woofer wires you can enjoy the Super Bass sound from the supplied speaker system.

▶ For personal listening

Connect headphone to headphone socket.

No sound comes from the speakers.

■ MUTE button(on remote control)

Press this button to mute your unit.

You can mute your unit in order, for example, to answer the telephone.

The M indicator appears on the display.

■ DISPLAY MODE button (on remote control)

Whenever you press the DISPLAY MODE button, you can enjoy the spectrum change with 11 types in the display.

■ MODE/RIF(Radio Interference Filter) button

To switch from mono to stereo reception and vice versa. If the power of transmission is too weak to receive stereo FM without interference, switch the STEREO off.

When a MW(AM), or LW broadcasting is being recorded, the R.I.F.(BEAT-SWITCH) button can be used to reduce unwanted "beat" signals and noise, which were not heard before recording.

■ DEMO button (optional) (In case of Auto Stop Deck)

Press this button in power on or off state to demonstrate the function in the display. To cancel it, press the POWER button or DEMO button. During demonstration in power-on status you can cancel it by using the other buttons.

NOTE : In case of Auto Reverse Deck

Press PLAY MODE button in power-off state to demonstrate for the function in the display. To cancel it, press the POWER button or PLAY MODE button.

■ Dimmer function (optional)

This function will be darken the display by half in power-on status, if you press the DIMMER button once, only the display will be darken, and if you press it once again the LEDs of the JOG DIAL and FUNCTION SELECTOR will go out. To cancel it press the button again.

RADIO RECEPTION

Tuning in Automatically

1. Turn on the power.
2. Turn the FUNCTION SELECT button repeatedly until the desired band appears.
3. Press the TUNING DOWN/UP(◀◀◀◀ or ▶▶▶▶) button. The unit tunes in a station automatically.

Tuning in Manually

1. Turn on the power.
2. Turn the FUNCTION SELECT button repeatedly until the desired band appears.
3. Turn the JOG DIAL to the left hand or right hand side repeatedly until the desired station appears.

Storing Stations

1. To clear any program previously stored in any memory

- (1) Press the PROG./MEMO button for more than 1.5 seconds in TUNER mode so that CLEAR is flashing in the display.
- (2) Press the ■/CLEAR button while CLEAR is flashing in the display.

2. To memorize the stations in order

- (1) Turn the FUNCTION SELECT button to select a desired wave band.
- (2) Select a desired station with the JOG DIAL.
- (3) Press the PROG./MEMO button and preset number flashes.
- (4) Press the PROG./MEMO button again while preset number is flashing.
- (5) Repeat step (1) to (4) to memorize up to 30 stations.

3. To memorize in selecting or adding channel number

- (1) Select a desired station.
- (2) Press the PROG./MEMO button.
- (3) Select a desired channel number by pressing the PRESET DOWN / UP button, while the preset number flashes.
- (4) Press the PROG./MEMO button again before the channel number stops flashing.

4. To recall presets

Press and hold the PRESET DOWN / UP button until the desired preset number appears or press it repeatedly.

RDS (Radio Data System) Reception (OPTIONAL)

What is RDS?

RDS (Radio Data System) is a system gradually being introduced on FM in many countries, where by an inaudible stream of data is transmitted in addition to the normal radio signal. This data contains various information including station / transmitter identification, traffic information and a list of alternative frequencies for the radio station being received.

Reception of RDS Stations

1. Turn the FUNCTION SELECTOR to select FM.
2. Select a desired station by using the JOG DIAL.
3. When the RDS transmission is received, the display shows the program service name (PS) after RDS indicator appears.

Notes:

- RDS is only available for FM reception.
- The PS (PROGRAM SERVICE) NAME is displayed automatically when a RDS station is received.

To recall the frequency

Press the RDS button.

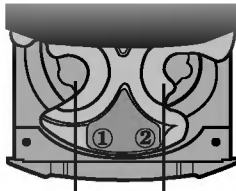

Number 1 disc Number 2 disc

Basic Operation

1. Select the CD FUNCTION by turning the FUNCTION SELECTOR.
2. Press the CD OPEN/CLOSE (CD ▲) button to open the disc compartment.
3. Load disc (s) with the label side up.
 - **Playing one or two discs**
Place discs on trays 1 and 2.
 - **Playing three discs**
After placing two discs, press the DISC SKIP button to rotate the trays. Place the next disc on tray 3.

NOTICE

To load an 8cm(3 in.) disc, put it onto the inner circle of the tray.

4. Press the CD OPEN/CLOSE (CD ▲) button to close the disc compartment.
5. Press the PLAY (▶) (or ▶/|| on remote control) button to start play.

During playback

A tray which has no disc is skipped and play proceeds to the next tray. The indicator of the skipped tray number goes out in the display.

To stop play

Press the ■/CLEAR button.

To pause

Press the CDII/SET (or ▶/|| on remote control) button.

To resume play, press it again.

To skip discs

During play or in the stop mode, press the DISC SKIP button.

During play

Play begins automatically after skipping.

In the stop mode

The changer skips to the next disc, but the player remains stopped. Press the PLAY (▶) (or ▶/|| on remote control) button to play the next disc. Play begins and all the discs are played once.

To play one disc only

Press one of the DISC DIRECT PLAY(DISC 1,2,3) buttons to start play.

To remove discs

Press the CD OPEN/CLOSE (CD ▲) button to open the disc compartment. You can remove two discs.

To remove the disc on the back tray, press the DISC SKIP button to rotate the disc tray.

Changing Discs During Play

Two discs can be changed while the other remaining disc is played. This operation is not applicable during programmed play.

1. Press the CD OPEN/CLOSE (CD ▲) button to open the disc compartment.
2. Remove the discs and replace with other discs.
The disc placed on the left side tray will be played next.
3. Press the CD OPEN/CLOSE (CD ▲) button to close the disc compartment.

NOTES



- Do not place more than one compact disc on one disc tray at the same time.
- If, during CD play, the video image of a nearby television is distorted, or if static is heard from a nearby radio, move this unit further away from the affected television or radio.

Searching for a Particular Point in a Track

You can locate a particular point in a track during play by monitoring the high-speed cueing sound or observing the CD counter in the display.

To search back:

Keep the ◀◀◀ button pressed and release it at the desired point.

To search forward:

Keep the ▶▶▶ button pressed and release it at the desired point.

Skipping to the Beginning of a Track

You can locate the beginning of any track on a disc.

To return to the beginning of the current or previous track

Press the **◀◀◀◀** button once to return to the beginning of the current track

Press the **◀◀◀◀** button repeatedly to skip tracks backward one by one.

To skip tracks

Press the **▶▶▶▶** button repeatedly to skip track(s) forward one by one.

Repeat Play

(Operating with only the remote control)

To play one track repeatedly

Press the REPEAT button to display “**G₁**” and press the PLAY/PAUSE **▶/||** (**▶**: on unit) button to start play.

To play one disc repeatedly

Press the REPEAT button twice to display “**G₁^{ALL DISC}**”. and press PLAY/PAUSE **▶/||** (**▶**: on unit) button to start play.

To play all tracks on all discs repeatedly

Press the REPEAT button three times to display “**G^{ALL DISC}**”, and press the PLAY/PAUSE **▶/||** (**▶**: on unit) button to start play.

To repeat only selected tracks

Program the desired tracks, and press the REPEAT button to display “**G₁**” or “**G^{ALL DISC}**”.

To cancel repeat play

Press the REPEAT button so that “**G**” in the display goes out.

NOTICE

- During the programmed play, you can play repeatedly one track (**G₁**) or all discs (**G^{ALL DISC}**).
- During the repeat play of an entire disc, if you select the programmed play, it is changed to repeat play of all discs.

Programmed Play

The player has a memory function that allows play of up to 20 tracks over three discs in any order.

1. Press the **PROG. / MEMO.** button in the stop mode.
2. Press one of the **DISC DIRECT PLAY** buttons or **DISC SKIP** button to select a disc.
3. Press the **◀◀◀◀** or **▶▶▶▶** button to select the track.
To select the 6th track, press the **◀◀◀◀** or **▶▶▶▶** button repeatedly until track number “6” is displayed in the display.
4. Press the **PROG. / MEMO.** button.
5. Repeat steps 2 to 4.
6. Press the **PLAY ▶** (**▶/||** : on remote control) button to start play.

To check the programmed contents

Each time the **PROG. / MEMO.** button is pressed in the stop mode, a disc number, a track number, and a program number will be displayed.

To clear the programmed contents

- Press the **PROG. / MEMO.** button during stop and then press the **■/CLEAR** button.
- Turn off the power.
- Press the **CD OPEN / CLOSE (CD ▲)** button.

To add tracks to the programme

- (1) Press the **PROG. / MEMO.** button to search until 00 appears in the track number.
- (2) Select the desired track on the disc with **DISC SKIP** button and **◀◀◀◀** or **▶▶▶▶** button.
- (3) Press the **PROG. / MEMO.** button.

To change the programmed tracks

- (1) Press the **PROG. / MEMO.** button to display the changed program number.
- (2) Select the desired track on the disc with **DISC SKIP** button and **◀◀◀◀** or **▶▶▶▶** button.
- (3) Press the **PROG. / MEMO.** button.

NOTICE

- The **DISC SKIP (D.SKIP)** button does not operate during programmed play.

AUXILIARY FUNCTION

1. Switch on the auxiliary device i.e. TV or VCR, connected to the rear mounted "AUX" sockets.
2. Press the "AUX" function button.

NOTE:

You can also record from the auxiliary input source, see RECORDING section.

TAPE PLAYBACK

Playback

Preparation

- ▶ You can use only normal tapes.

1. To set the cassette function

Switch the unit on and press the TAPE 1/2 button. (If necessary press the button again to select the other deck.)

2. To insert cassettes

Open cassette deck 1 (or 2) or both by pushing the deck ▲ PUSH EJECT position. Insert one or two cassettes with the tape side to the bottom and the cassette side that you wish to hear facing the front in cassette deck 1 or 2.

NOTE:

DECK 1 - Auto stop only (Non-auto reverse)

DECK 2 - Auto reverse

3. Auto reverse

Select which side of the cassette is to be played and how often with the PLAY MODE button.

1) 1st Option

In case of non-autoreverse (auto stop) deck 1 and auto reverse deck 2.

In this case, the continuous play between deck 1 and 2 cannot be performed.

(a) DECK 1

Front side play only.

(b) DECK 2 (Auto Reverse)

One side ≡ : Unit plays the front or reverse side in deck 2 and stops automatically at the end of the tape.

All sides ≡ : Unit plays the front and reverse side in deck 2 and stops automatically at the end of the tape.

Endless loop ≡ : Like ≡ but six times in succession in deck 2.

2) 2nd Option

In case of non-autoreverse (auto stop) deck 1 and 2. (Front side play only)

4. Playback:

Start playback with PLAY button ▶ (front side) or ◀ (reverse side).

5. Fast forward or rewind :

Press button ►►►► on the unit or on the remote control for fast forward and ◀◀◀◀ to rewind.

6. To end playback :

Press the ■/CLEAR button.

The unit stops automatically at the end of the tape.

Tape Counter Reset

Press the COUNTER button while tape playing or stop.

Recording from a CD, Radio or Connected Equipment

Preparation

- ▶ Wind up the tape to the point recording starts.
- ▶ Use only normal tapes.
- ▶ You can record from cassette deck 2 only.

1. To select the function

Switch the unit on and select CD, TUNER, AUX etc.

2. To insert the cassette

Open the cassette deck 2.
Insert a blank cassette into the cassette compartment.

3. PLAY MODE (OPTIONAL)

Select the play mode with PLAY MODE button, \rightleftharpoons if you wish to record one cassette side only and \rightarrow or \leftarrow for both cassette sides.

4. Recording mode :

Press the ●REC/|| button.
The REC indicator flashes and holds the cassette in pause mode.

5. To start recording :

Press the ●REC/|| button or PLAY button ▶ again if you want to record the front side or ◀ for the reverse side (OPTIONAL). The recording begins.

NOTE :

If both cassette sides are to be recorded (PLAY MODE \rightleftharpoons , \rightarrow) always start with the front side PLAY \leftarrow . (Use only auto reverse deck)

6. To interrupt recording :

To interrupt the recording for a short period, press the ●REC/|| button again.
To continue with the recording, press the ●REC/|| button one more time.

7. To end the recording :

Press the ■/CLEAR button.
The unit stops automatically at the end of the tape.

CD Synchro Recording

The CD synchro recording function dubs a complete CD and programmed titles automatically into a cassette.

1. Select the CD function.

2. Open the CD compartment with the CD OPEN / CLOSE (CD ▲) button, insert discs and close the CD compartment again.

3. To insert cassette

Open the cassette deck 2.
Insert a blank cassette into the cassette compartment.
Rewind the cassette to the beginning of the tape.

4. Auto reverse (OPTIONAL)

Select the PLAY MODE, \rightleftharpoons if you only wish to record the front side and \rightarrow or \leftarrow for both cassette sides.

NOTE:

If the last track has stopped because the tape is full, the track will be recorded again completely on the reverse side of the cassette tape.

5. To start recording

Press the CD SYNC. button.
The recording begins and stops automatically at the end of the CD.

NOTE:

In case of Auto Stop deck (OPTIONAL)

If you want to record onto another tape after one has ended. Change the tape, then push the PLAY button. The tape enters into the recording mute mode for 7 seconds then CD player starts playing and recording.

NOTES :

1. If you only want to record certain titles, program these before the CD synchro recording.
2. If you wish to record from the desired track, select the desired track with the (◀◀◀/▶▶▶) button before commencing CD synchro recording.
3. The function change is not possible during recording.

Recording from Tape to Tape (Dubbing)

Preparation

- ▶ Wind up the tape to the point recording starts.
- ▶ Use only normal tapes.
- ▶ Dubbing only functions from cassette deck 1 (playback) to cassette deck 2 (recording).

1. Select the TAPE function.

2. To insert cassettes

Open cassette deck 1.

Insert a recorded cassette and the cassette side that you wish to dub to the front.

Open cassette deck 2.

Insert a blank cassette in the cassette compartment and the cassette side that you wish to record to the front.

3. To dub(auto dubbing)

Rewind both cassettes to the beginning of the tape. Press NORMAL DUBBING for normal and HIGH DUBBING for double speed dubbing. The dubbing starts up automatically.

NOTE : The pause function does not operate during dubbing.

4. To end dubbing

Press the ■/CLEAR button.

The unit stops automatically at the end of the tape.

NOTE : You cannot change the speed of dubbing while dubbing.

The volume has no effect on the record level.

TIMER

Timer Setting

With the TIMER function you can have the radio reception and recording, CD play, tape play or play and recording from auxiliary source turned on and off at the time desired.

1. Check the current time.

2. Press the TIMER button to enter the timer setting mode.

(If the timer is already set, press the button for more than 1.5 seconds.)

⓪ indicator appears in the display and each function (TUNER, CD, TAPE, AUX) flashes in the display in turn.

3. If you want to select the TUNER, press the CDII/SET button until the TUNER appears in the display window.

'PLAY' and 'REC' flashes in turn.

(1) Press the CDII/SET button to confirm either PLAY and REC.

PLAY : TUNER play only

REC : TUNER play and recording

(2) Turn the JOG DIAL to select a desired radio station of the previous programmed preset numbers.

If the radio stations have nothing in the memory, this step is automatically skipped and you can operate continuously from step (3); in this case, it will play the radio broadcast that was being received before turning off the unit.

(3) Press the CDII/SET button to confirm the selected preset number.

(4) Set the hour to switch on by turning the JOG DIAL.

(5) Press the CDII/SET button to confirm the hour to switch on.

The minute flashes.

(6) Set the minute to switch on turning the JOG DIAL.

(7) Press the CDII/SET button to confirm the minute to switch on.

Now OFF TIME appears and the hour flashes in the display.

- (8) **Program the time to switch off in the same way as the time to turn on.**
- (9) **Set the volume level by turning the JOG DIAL.**
- (10) **Press the CDII/SET button to confirm the selected volume level.**
 remains in the display and the timer setting has been perfected.
- (11) **Switch the system off.**
 The selected function is automatically switched on and off at the time set.
 - ▶ **If you select the AUX:**
 Follow steps (1)~(11) except steps (2)~(3) of '3. If you want to select the TUNER'.
 - ▶ **If you select the CD or TAPE:**
 Follow steps (4)~(11) of the '3. If you want to select the TUNER'. explanation section.

4. To cancel or check the timer

Each time the TIMER button is pressed you can select the timer activating or cancel. You can also check the timer setting status.

To activate or check the timer, press the TIMER button so that " " lights up in the display.

To cancel the TIMER, press the TIMER button so that " " in the display goes out.

NOTES:

1. When the CD or TAPE is selected for playback, if no disc is entered in the disc drawer or no cassette tape is entered in the cassette deck, the TUNER function will be operated.
2. When the CD programmed playback is selected, the REPEAT ALL DISC( ALL DISC) will be selected automatically.

3. When the TAPE is selected for playback, if both cassette decks have cassette tapes in; the cassette tape in deck 2 will be selected first.
4. The timer-off function will be operated only in the case of power-on by the timer on.

Sleep Timer Setting

(Operating with only the remote control)

When the sleep timer is used, the power is automatically turned off after the specified time has elapsed.

1. To specify the time until the power is turned off, Press the SLEEP button.

In the display you can see *SLEEP 90* for about 5 seconds. This means that the units turns off automatically after 90 minutes.

Each time the button is pressed the time interval before it turns off is reduced by 10 minutes. i.e. 80...70...etc.

Select the desired time to turn off.

2. To check the remaining time until the power is turned off.

While the sleep function is active press the SLEEP button briefly. The time remaining until it turns off is displayed for about 5 seconds.

NOTE:

If you press the SLEEP button while the sleep time is displayed, the SLEEP time is set again.

3. To cancel the sleep timer mode

If you wish to stop the function press the SLEEP button repeatedly until 10 appears, and then press the SLEEP button once again while 10 is displayed.

AUTO FUNCTION SELECT SYSTEM

This unit has an auto function select system for various functions. i.e. If a function is in operation(e.g. radio reception), and you wish to switch to another(e.g. cassette playback), all you have to do is select the desired function(cassette playback) directly, the unit automatically switches to the new function(cassette recorder).This applies for the following functions:

1. On the remote control

TUNER : PRESET \wedge / \vee buttons
 CD : PLAY/PAUSE(\blacktriangleright /||) button
 TAPE : FORWARD (\blacktriangleright) and REVERSE (\blacktriangleleft)
 PLAY button (OPTIONAL)

2. On the unit

CD : DISC DIRECT PLAY buttons
 (DISC 1, 2, 3)

SPECIFICATIONS

SECTION \ MODEL	FFH - 877	FFH - 977
AMP Output Power(MAIN) Output Power(Super Woofer) Frequency Response(MAIN) Frequency Response(Super Woofer) Signal-to-Noise Ratio(MAIN) Signal-to-Noise Ratio(Super Woofer)	100W+100W (6Ω, 2ch, T.H.D 10%) 42~25000 Hz 83 dB	30W +30W(6Ω, 2ch, T.H.D 10%) 120W+120W (6Ω, 2ch, T.H.D 10%) 700~25000 Hz 45~700Hz 83 dB 75 dB
TUNER FM Tuning Range(optional) Intermediate Frequency Signal-to-Noise Ratio (Mono/Stereo, 98MHz) Frequency Response AM(MW) Tuning Range(optional) Intermediate Frequency Frequency Response SW(OPTIONAL) Tuning Range Intermediate Frequency Signal-to-Noise Ratio(11MHz) LW(OPTIONAL) Tuning Range Intermediate Frequency Signal-to-Noise Ratio(254kHz)	87.5~108 MHz or 65~74 MHz & 87.5~108 MHz 10.7 MHz 61/58 dB 60~10000 Hz 522~1611 kHz, 530~1720 kHz or 530~1610 kHz 450 kHz 100~1900 Hz 5.8~18.0 MHz 450 kHz 35 dB 153~281 kHz 450 kHz 28 dB	87.5~108 MHz or 65~74 MHz & 87.5~108 MHz 10.7 MHz 61/58 dB 60~10000 Hz 522~1611 kHz, 530~1720 kHz or 530~1610 kHz 450 kHz 100~1800 Hz 5.8~18.0 MHz 450 kHz 35 dB 153~281 kHz 450 kHz 28 dB
CASSETTE DECK FF, REW Time(C-60) Frequency Response Signal-to-Noise Ratio Channel Separation	120 sec. 125~8000 Hz 43 dB(P/B), 43dB(R/P) 50 dB(P/B), 45dB(R/P)	120 sec. 125~8000 Hz 43 dB(P/B), 43dB(R/P) 50 dB(P/B), 45dB(R/P)
CD Frequency Response Signal-to-Noise Ratio	40~18000 Hz 70 dB	50~18000 Hz 70 dB
GENERAL Power Requirements Net Dimensions(WxHxD) Net Weight	Refer to the back panel of the unit. 273 x 326 x 360 mm 8.3 kg	Refer to the back panel of the unit. 273 x 326 x 360 mm 9.1 kg
SECTION \ MODEL	FE - 877E	FE - 977E
SPEAKER SYSTEM Type Impedance Frequency Response(MAIN) Sound Pressure Level(MAIN) Rated Input Power(MAIN) Rated Input Power(SUPER WOOFER) Max. Input Power(MAIN) Max. Input Power(SUPER WOOFER) Net Dimensions(WxHxD) Net Weight	Bass Reflex 3 Way 3 Speaker System 6 Ω 50~20,000 Hz 87 dB/W(1m) 100W 200W 230 x 401 x 289 mm 4.80kg	Bi AMP (Main Speaker, Super Woofer) 3 Way 3 Speaker System 6 Ω 120~20,000 Hz 90 dB/W(1m) 30W 120W 60W 240W 240 x 444 x 334 mm 6.05kg

* NOTE : Designs and specifications are subject to change without notice for improvement.