



LG Electronics Inc.



LG

Floor Standing Type Air Conditioner

OWNER'S MANUAL

Please read through this manual. It contains valuable information about your air conditioner. This manual may help save time and money by explaining proper product maintenance and preventing improper use.

Pay close attention to precautions in order to prevent potential hazards and damage from misuse or improper installation. LG is not responsible for any damages caused by misuse of the product.

Prior to installation, the air-conditioning unit must be submitted for approval by the utility service company that provides electricity (EN 61000-3-2, Class B).

TABLE OF CONTENTS

- a. Features and Specifications
- b. Indoor Unit Controls and Indicators
- c. Name and Function-Remote Control
- d. Air conditioner Operation

Keep Your Records

Write the model and serial numbers here:

Model # _____

Serial # _____

You can find them on a label on the side of each unit.

Dealer's Name _____

Date Purchased _____

Read This Manual

Inside you will find many helpful hints on how to use and maintain your air conditioner properly. Just a little preventive care on your part can save you a great deal of time and money over the life of your air conditioner.

You'll find many answers to common problems in the chart of troubleshooting tips. If you review our chart of

Troubleshooting Tips first, you may not need to call for service at all.



CAUTION

- Contact the authorized service technician for repair or maintenance of this unit.
- Contact the installer for installation of this unit.
- The air conditioner is not intended for use by young children or invalids without supervision.
- Young children should be supervised to ensure that they do not play with the air conditioner.
- When the power cord is to be replaced, replacement work shall be performed by authorized personnel only.
- Installation work must be performed in accordance with the national wiring standards by authorized personnel only.

To prevent injury and property damage, follow these instructions.

- Incorrect operation due to ignoring instructions will cause harm or damage, the seriousness of which is indicated by the following symbols.



WARNING

This symbol shows the possibility of death or serious injury.



CAUTION

This symbol indicates the possibility of injury or damage to property.



Never Do This



Always Do This

- The following items are classified by these symbols.

WARNING

- **Do not install, remove and re-install the unit by yourself.**

Improper installation will cause water leakage, electrical shock, or fire. Please consult authorized dealer or specialist for the installation work.

CAUTION

- The reverse cycle system of the air conditioner is based on the air cooling type heat pump which absorbs heated air from the outdoor unit and discharges it indoor.

Therefore if the outdoor unit is exposed to very low temperature, specifically below 0°C, the heating capacity drops off rapidly.

OPERATING TEMPERATURE(°C)

COOLING MODE

INDOOR		OUTDOOR	
MAX.	MIN.	MAX.	MIN.
32°C	21°C	43°C	21°C

HEATING MODE

INDOOR		OUTDOOR	
MAX.	MIN.	MAX.	MIN.
27°C	20°C	24°C	1°C

WARNING

Do not touch the fan blades or use an unspecified cord.

- It will cause electrical shock or fire.

Do not operate with wet hand.

- It will cause electrical shock.

Do not insert anything into the air inlet/air outlet.

- Since the fan rotates at high speed, this may cause an injury or damage the unit.

Do not expose the skin directly to cool air for long periods of time.

- This could damage your health.

When an abnormality (smell, humming, etc) occurs, stop the air conditioner, and disconnect the power plug or turn off the power switch.

- If the unit continues to operate in an abnormal condition, it may cause fire, damage, etc. In this case, consult your dealer.

Repair or relocation should not be done by the customer.

- If this is done incorrectly, it may cause a fire, electric shock, injury by dropping of the unit, water leakage, etc. Consult your dealer.

⚠ CAUTION ⚠

- Contact the authorized Service technician for repair or maintenance of this unit.
- Contact the installer for installation of this unit.
- The air conditioner is not intended for use by young children or infirm persons without supervision.
- The appliance is not intended for use by young children or infirm persons without supervision.
- Young children should be supervised to ensure that they do not play with the appliance.
- If the supply flexible cord is damaged, it must be replaced by the manufacturer or the manufacturer's service agent or similarly qualified person in order to avoid hazard.

⚠ CAUTION ⚠



- It may cause an injury.
- Should be disconnected from supply



- Water may enter the unit and degrade the insulation. It may cause an electric shock.



- An oxygen shortage may occur.



- It may cause an electric shock, burning.



- This could injure the pet or plant.



- The unit may drop or fall down and cause an injury.



- It may cause a fire or deformation of the cabinet.



- It may affect combustion.



- It may cause an injury through dropping or falling down.



- It will cause an injury, electric shock by the high voltage.



- If not, dirt may collect and cause a fire.



- It may cause an injury, electric shock by the high voltage.



- Do not use this air conditioner to preserve precision devices, food, animal, plants, and art objects.
It may cause deterioration of quality, etc.



- In the cooling mode, if it is operated in a room with high humidity (80%RH or more) for a long time, water condensed in the air conditioner may drop and may wet and spoil furniture, etc.

- Design for cooling & Heating
- Super energy efficiency
- Micom control
- Whisper quiet operation
- Wireless remote control
- 2 cooling speeds
- Removable air filter
- Anti-Bacteria filter
- 3 minutes delay circuit
- Jet Cool operation
- Energy saving
- Auto restart
- Plasma Air Purifying system (CA/HA/ZA MODEL)

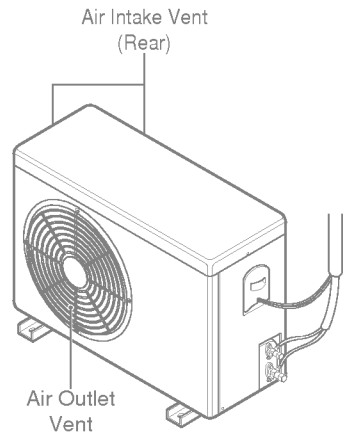
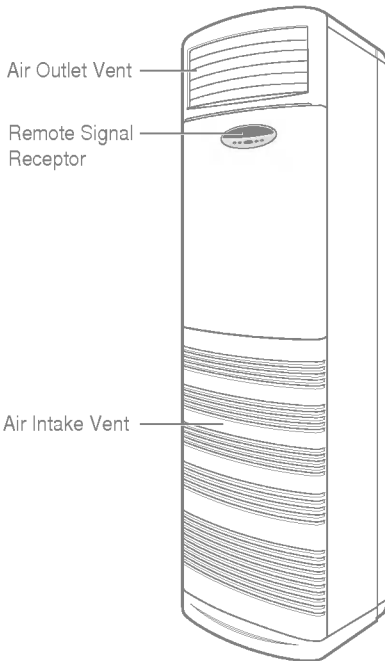

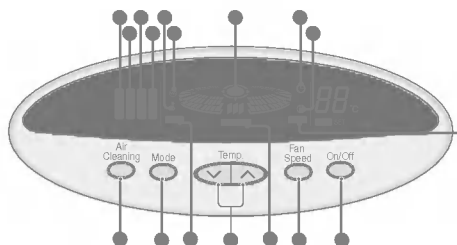

(Heat Pump Model)

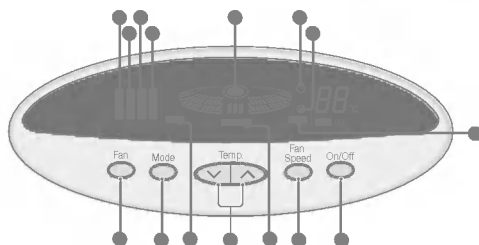

(Cooling Model)

- **START/STOP BUTTON**
Operation starts when this button is pressed and stops when the button is pressed again.
- **OPERATION MODE SELECTION BUTTON**
Used to select the operation Mode.
- **INDOOR FAN SPEED SELECTION**
Used to select fan speed in two steps-low, high.
- **FAN OPERATION BUTTON**
Used to circulate room air without cooling.
- **ROOM TEMPERATURE SETTING BUTTONS**
Used to select the room temperature.
- **COOLING OPERATION LAMP**
- **HEATING OPERATION LAMP**
- **SOFT DRY OPERATION LAMP**
- **AUTO OPERATION LAMP**
- **JET COOL OPERATION LAMP**
- **ENERGY SAVING OPERATION LAMP**
- **OFF TIMER OPERATION LAMP**
- **FAN OPERATION LAMP(CL/HL/ZL MODEL)**
- **AUTO AIRFLOW OPERATION LAMP(VERTICAL)**
- **TELE-CONTROL OPERATION LAMP (OPTIONAL)**
- **PLASMA AIR PURIFYING BUTTON(CA/HA/ZA MODEL)**
- **AIR CLEANER OPERATION LAMP(CA/HA/ZA MODEL)**
- **ELECTRIC HEATER OPERATION LAMP(OPTIONAL)**
- **DEFROST OPERATION LAMP**

The remote control transmits the signals to the system.

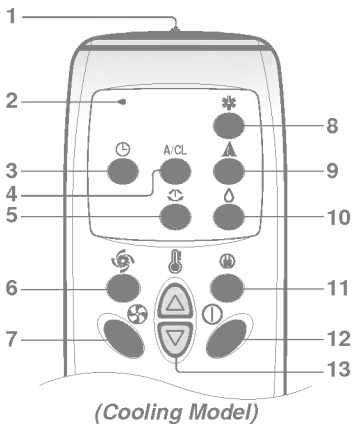
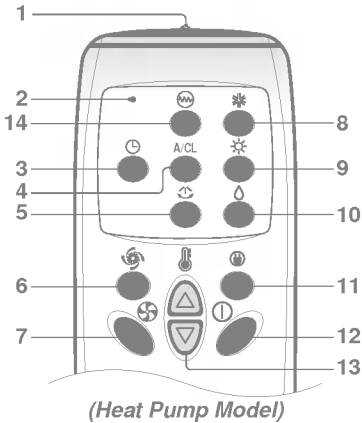

● **Signal Transmitter**

- Transmits the signals to the Floor Standing Type air conditioner

● **Operation Display of the Remote Control**

● **Timer Set Button**

- Each time the button is pressed, the mode is changed in the following process.

Timer set (1, 2, 3, 4, 5, 6, 7 hours)

If you select "0:00" the off Timer function will be canceled.

● **Plasma Air Purifying Button(CA/HA/ZA MODEL)**

Fan Operation Button(CL/HL/ZL MODEL)

● **Auto Airflow Direction Control Button**

- The vertical louvers swing left and right.

● **Jet Cool Operation Button**

● **Indoor Fan Speed Selection Button**

- To select the desired fan speed in two steps [Low, High]

● **Cooling ON Button**

● **Heating Button (Heat Pump Model Only)**

Auto Operation Button(Cooling Model Only)

● **Soft Dry Operation Button**

● **Energy Saving Operation Button**

● **Power ON/OFF Button**

- Operation will start when this button is pressed, and stop when the button is pressed again.

● **Temperature Setting Buttons**

● **Electric Heater ON/OFF Button(Optional)**

Wireless Remote Control Puts all functions at your fingertips

Handling the remote control

- Aim at the signal receptor on the Floor Standing Type air conditioner when operating.
- The remote control signal can be received at a distance of up to about 7meters.
- Be sure that there are no obstructions between the remote control and the signal receptor.
- Do not drop or throw the remote control.
- Do not place the remote control in a location exposed to direct sunlight, or next to a heating unit, or other heat source.

How to mount on a wall

- Use the screws to secure the holder to the wall or attach the holder side of indoor unit.

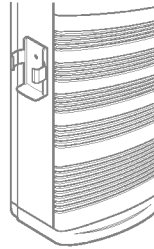
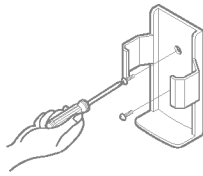

- To insert the remote control to the holder.

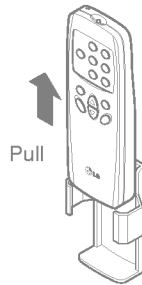
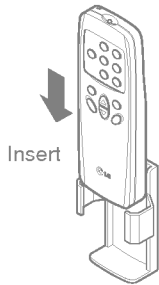

How to insert batteries

- Remove the cover from the back of the remote controller.
 - Slide the cover according to the arrow direction.
- Insert two batteries.
 - Be sure that the (+) and (-) directions are correct.
 - Be sure that both batteries are new.
- Re-attach the cover.
 - Slide the cover into back position.

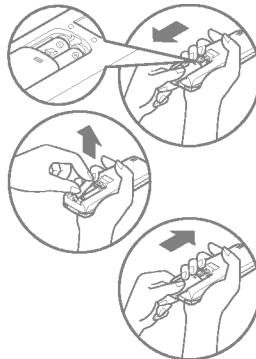

- Do not use rechargeable batteries such as batteries are different from standard dry cells in shape, dimensions, and performance.
- Change the batteries with a new one if the remote control does not work properly after using for an extended length of time.

- Each time the Operation Mode Selection Button is pressed, the Operation Mode is shifted in the arrow direction.

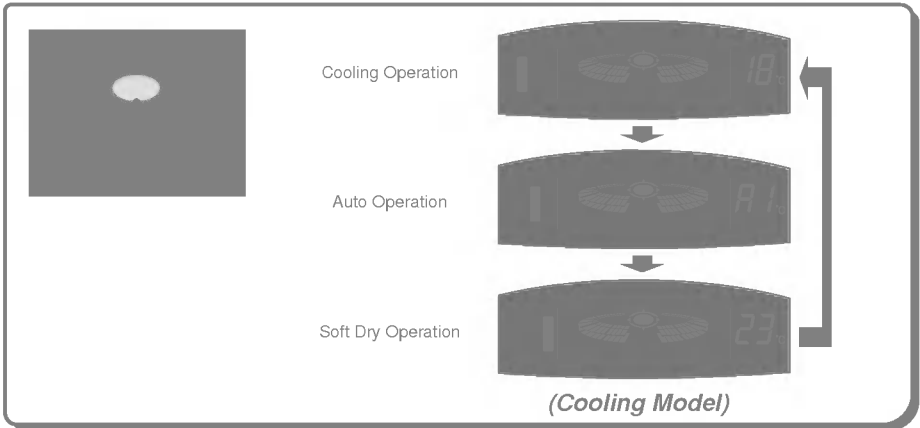
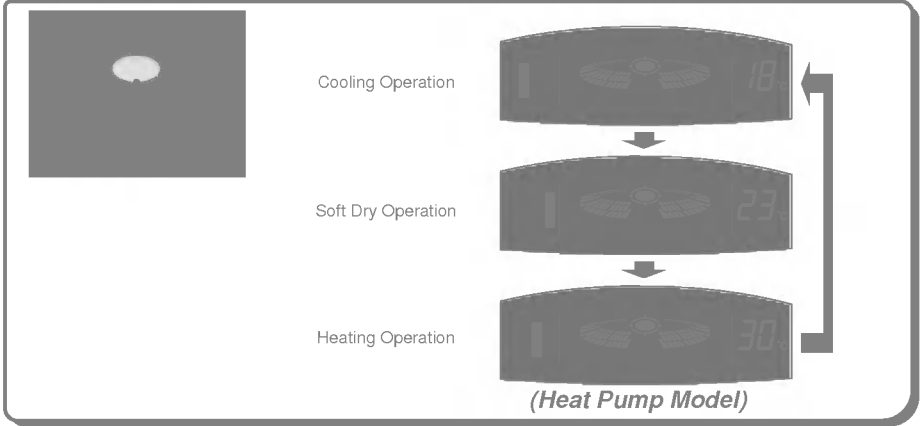

- Each time the Fan speed Button is pressed, the Fan speed is shifted in the arrow direction.

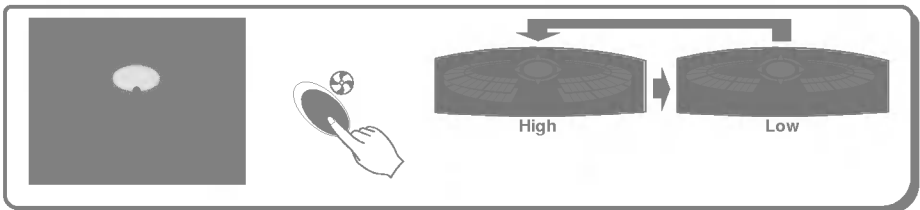



Press the Start/Stop Button.

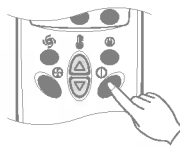

Select **Cooling Operation**. Press the Operation Mode Selection Button. Press the Cooling Operation Button on the remote controller.

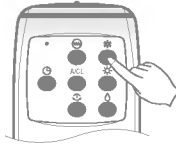
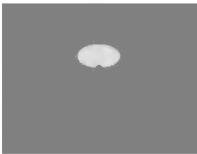

Set the temperature lower than the room temperature.
The temperature can be set within a range of 16°C~30°C by 1°C.

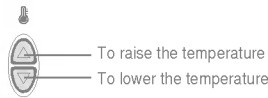

When you finish the temperature setting.



After 4 seconds →



Set the Fan Speed.

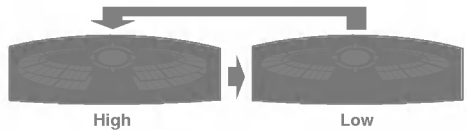
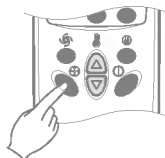

Each time the Fan Speed Button is pressed, the Fan Speed mode is shifted in the arrow direction.



Press the Start/Stop Button.



Select Soft Dry Operation.
Press the Operation Mode Selection Button.
Press the **Soft Dry Operation** Button on the remote controller.

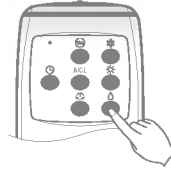

Set the temperature lower than the room temperature.
The temperature can be set within a range of 16°C~30°C by 1°C.

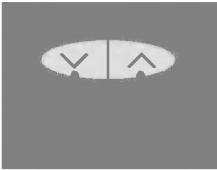

To raise the temperature
To lower the temperature



During soft Dry Operation

• The indoor fan speed is automatically set to low and can be set fan speed.

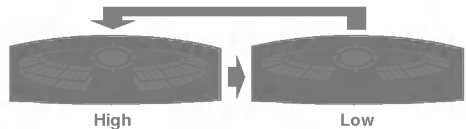



Press the Start/Stop Button.

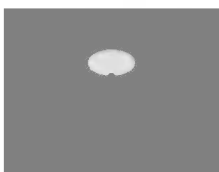

Press the **Jet Cool** button to operate the speed cooling mode and the unit will operate in super high fan speed on cooling mode.



To cancel the **Jet Cool** mode, press the **Jet Cool** button again or the fan speed button or the room temperature setting button and the unit will operate in high fan speed on cooling mode.

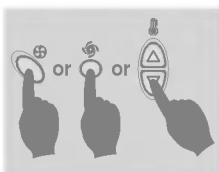

NOTE:

- During the JET COOL function at any moment, the A/C starts to blow the cool air at extremely high speed setting the room temp. automatically to 18°C. It is especially used to cool the room temp. in the shortest time in a hot summer.
In heat pump mode or neuro fuzzy mode however, the JET COOL function is not available.
- In order to return to the normal cooling mode from the JET COOL mode, you just press either the operation mode selection button, airflow volume selection or temp. setting button or the JET COOL button again.



Press the Start/Stop Button.

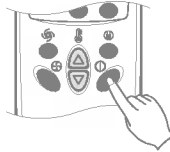

Select heating Operation.
Press the Operation Mode Selection Button.
Press the **Heating Operation** Button on the remote controller.

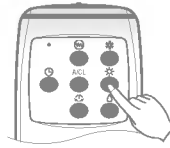

Set the temperature lower than the room temperature.
The temperature can be set within a range of 16°C~30°C by 1°C.



To raise the temperature
To lower the temperature



Set the Fan Speed.

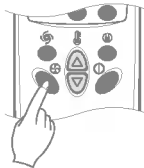
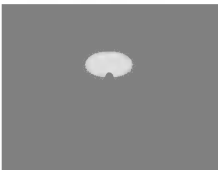

* Each time the Button is pressed, the Fan Speed mode is shifted.



Press the Start/Stop Button.



Select heating + E/heater Operation.

Press the Operation Mode Selection Button.

Press the **Heating Operation** Button on the remote controller. (When the unit operates in heating mode.)

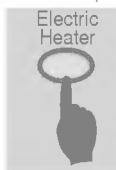
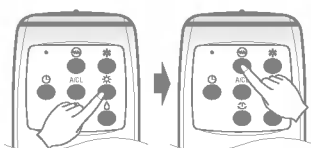

Set the temperature lower than the room temperature.

The temperature can be set within a range of 16°C~30°C by 1°C.



To raise the temperature

To lower the temperature



Set the Fan Speed.



* Each time the Button is pressed, the Fan Speed mode is shifted.



Press the Start/Stop Button.

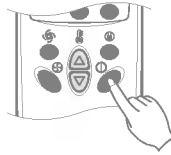

Select Auto Operation.
Press the Operation Mode Selection Button.
Press Auto Operation Button on the remote controller.

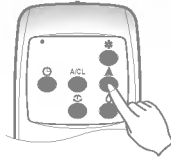

Set the temperature upper than the room temperature.
The temperature can be set within a range of -2~2 by 1 level.

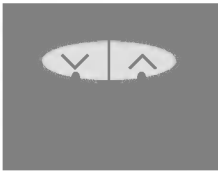

(This indication will be shifted to the initial Auto Mode Display state after 4 seconds.)



— To raise the temperature (When you feel too cool or cold)
— To lower the temperature (When you feel too warm or hot)



During Auto Operation

- It is impossible to switch the indoor fan speed because of being already set to the best condition by fuzzy rule.



Press the Start/Stop Button.

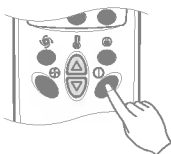

Select Energy Saving mode.

You can select this function during the operation of Cooling/Auto/Soft Dry.



To cancel the Energy Saving mode, press the Energy Saving button again and the unit will operate on Cooling/Auto/Soft Dry mode.



Auto restart

In case the power comes on again after a power failure, Auto Restarting Operation is the function to operate procedures automatically to the previous operating conditions.



Press the Start/Stop Button.

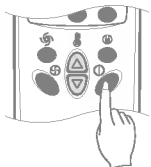

Press Fan Operation Button.

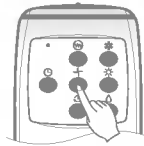

Set the Fan Speed.

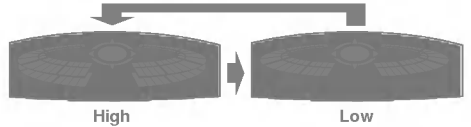

□ Each time the Fan Speed Button is pressed, the Fan Speed mode is shifted in the arrow direction.



Press the Start/Stop Button.

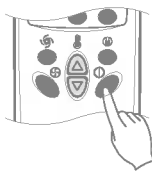

(Operation will start when the button is pressed, and stop when the button is pressed again.)



Press the Auto Swing Button and then louvers will swing left and right.

Press the Airflow Direction Control Button again to set the Vertical louver at the desired airflow direction.

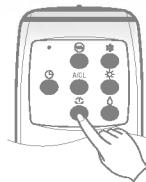

The vertical louver swing left and right.

Note

Always use the remote control to adjust the right/left airflow direction, manually moving the vertical airflow direction louver by hand could change the air conditioner.

Vertical Airflow Direction Control

Adjust the vertical airflow direction manually by moving the horizontal louvers with hand.

Air Purifying Operation only



Press the Plasma Air Purifying Operation Start/Stop Button.

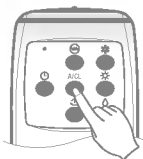

(Operation will start when the button is pressed, and stop when the button is pressed again.)



Select Fan speed.

The display shows low fan speed at the initial condition.

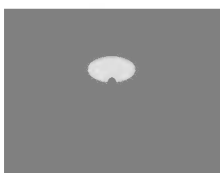

High

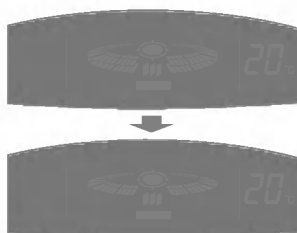

Low

- You can operate the Plasma Air Purifying under the unit operation of cooling, heating, soft dry or Auto mode.

Air Purifying Operation with Cooling or any other Operataion.



1. Press the Start/Stop Button.
2. Select the desired Operation Mode.
3. Press the Plasma Air Purifying Operation ON/OFF Button.
4. Set the fan speed.



Press the Start/Stop Button.



Press the Timer Button.

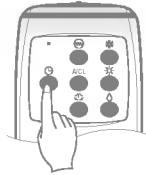

• If you press the button, the selected off timer is displayed as follows;

1 → 2 → 3 → 4 → 5 → 6 → 7 → 0

• If you select '0', the Off Timer function will be cancelled.



When you finish the Off Timer setting, the Timer indicator lights off.



During off-timer operation if you press the Timer Button, the rest time will be displayed.

CAUTION: Before performing any maintenance, turn off the main power to the system.

1 Remove the Air Filter.
Take hold of the tab and pull slightly forward to remove the filter.

2 Clean.
• To remove the dust adhering to the filters, either use a vacuum cleaner, or wash them in water and dry in the shade.
• Re-insert the filter to the original position.

- Don't wash with water.
- Wipe with a soft dry cloth.

1 Remove the Air Cleaner.
Take hold of the tab and pull slightly forward to remove the air cleaner.

2 Clean.
• Dip the air cleaner into the water mixed with detergent, for 20~30 minutes, and dry in the shade.
• Re-insert the air cleaner to the original position.

- Water hotter than 40 °C.
Could cause deformation and/or discoloration.
- Volatile substances.
Could damage the surfaces of the air conditioner.

1 Operate the air conditioner at the following settings for 2 to 3 hours.
• Type of operation : Cooling.
• Temperature setting : 30 °C.
This will dry out the internal mechanisms.

2 Remove the batteries from the Remote Control.

3 Turn off the circuit breaker.

CAUTION
Turn off the circuit breaker when the air conditioner is not going to be used for a long time.
Dirt may collect and may cause a fire.

1 Clean the air filters, re-insert, then operate the air conditioner.

2 Be sure that nothing obstructs the air outlet and intake vents.

This is not good for your health and wastes electricity.

Avoid opening doors and windows as much as possible to keep the cool air in the room.

Do not let direct sunshine enter the room when the air conditioner is in operation.

Blockages in the air filter reduce the airflow and lower cooling and dehumidifying effects. Clean at least once every two weeks.

Adjust the vertical and horizontal airflow direction to ensure a uniform temperature in the room.

Since windows are kept closed, it is a good idea to open them and ventilate the room now and then.

Check the following points before requesting repairs or service.... If the fault persists, please contact your dealer or service center.

Case	Explanation	See page
Does not operate.	• Have you made a mistake in timer operation?	
	• Has the fuse blown or has the circuit breaker been tripped? • Is the power Switch at Off? • Is the unit at the starting of Heating Operation? If yes, Hot-start is activating. • Is the unit in the Deicing? If yes, wait for finishing the Deicing.	-
The room has a peculiar odor.	• Check that this is not a damp smell exuded by the walls, carpet, furniture, or cloth items in the room.	-
It seems that condensation is leaking from the air conditioner.	• Condensation occurs when the airflow from the air conditioner cools the warm room air.	-
Air conditioner does not operate for about 3 minutes when restarted.	• This is the Protection device of the air conditioner . • Wait about three minutes and operation will begin. • If the airflow begins before its temperature become warm, it will cause an undesired cooling effect. In order to prevent this, the airflow will not begin until it is sufficiently warm.	
Does not cool or heat effectively.	• Is the air filter dirty? See air filter cleaning instructions.	20
	• The room may have been very hot when the room air conditioner was first turned on. Allow time for it to cool down.	-
	• Has the temperature been set incorrectly? • Are the indoor unit's air inlet or outlet vents obstructed?	-
The air conditioner operation is noisy.	• For a noise that sounds like water flowing. -This is the sound of freon flowing inside the air conditioner unit. • For a noise that sounds like the compressed air releasing into atmosphere. -This is the sound of the dehumidifying water being processed inside the air conditioning unit.	-
Remote controller display is faint, or no display at all.	• Are the batteries depleted? • Are the batteries inserted in the opposite (+) and (-) directions?	8

NOTE

WATER RESISTANT: The outdoor side of this appliance is WATER RESISTANT.

The indoor side is not water resistant and should not be exposed to excess water.

