



DVD HOME CINEMA SYSTEM

OWNER'S MANUAL

MODEL : DA-3530

(DA-3530A, FE-3500TE, FE-3500WE)



Before connecting, operating, or adjusting this product,
please read this instruction booklet carefully and completely.



WARNING: TO REDUCE THE RISK OF FIRE OR ELECTRIC SHOCK, DO NOT EXPOSE THIS PRODUCT TO RAIN OR MOISTURE.

CAUTION: THIS DVD RECEIVER EMPLOYS A LASER SYSTEM.

TO ENSURE PROPER USE OF THIS PRODUCT, PLEASE READ THIS OWNER'S MANUAL CAREFULLY AND RETAIN FOR FUTURE REFERENCE, SHOULD THE UNIT REQUIRE MAINTENANCE, CONTACT AN AUTHORIZED SERVICE LOCATION-SEE SERVICE PROCEDURE.

USE OF CONTROLS, ADJUSTMENTS OR THE PERFORMANCE OF PROCEDURES OTHER THAN THOSE SPECIFIED MAY RESULT IN HAZARDOUS RADIATION EXPOSURE.

TO PREVENT DIRECT EXPOSURE TO LASER BEAM, DO NOT TRY TO OPEN THE ENCLOSURE. VISIBLE LASER RADIATION WHEN OPEN THE ENCLOSURE. DO NOT STARE INTO BEAM.

THE APPARATUS SHALL NOT BE EXPOSED TO DRIPPING OR SPLASHING AND THAT NO OBJECTS FILLED WITH LIQUIDS, SUCH AS VASES, SHALL BE PLACED ON THE APPARATUS.

WARNING: CHANGES OR MODIFICATIONS NOT EXPRESSLY APPROVED BY THE PARTY RESPONSIBLE FOR COMPLIANCE COULD VOID THE USER'S AUTHORITY TO OPERATE THE EQUIPMENT.

RECORD YOUR MODEL NUMBER (Now, while you can see it)

The model and serial number of your new DVD receiver are located on the back of the DVD receiver cabinet. For your future convenience, we suggest that you record these numbers here:

MODEL NO. _____

SERIAL NO. _____

Introduction

- ❑ Safety Precautions 2
- ❑ Table of Contents 3
- ❑ Precautions 4
- ❑ Notes on Discs 5
- ❑ Identification of Controls 6-9
 - Front Panel/Display window 6
 - Rear Panel 7
 - Remote Control 8
 - Preparing the Remote Control 9
 - Operating with the Remote Control 9

Connections

- ❑ Antenna Connections 10
- ❑ Speaker System Connection 11
- ❑ Connecting to a TV and VCR 12

Basic Operations

- ❑ Basic Playback 13-14
- ❑ Special Playback 15-16
 - Still Picture 15
 - Frame Advance 15
 - Skipping chapters and tracks forward or back . . . 15
 - Scanning at High Speed 16
 - Playing in Slow-Motion 16

Operation Using GUI Menu Icons

- ❑ General Information about GUI menu icons 17
- ❑ Detailed description of each GUI menu icon . . . 18

Advanced Operation

- ❑ Using a title menu 19
- ❑ Using a DVD menu 19
- ❑ Memorizing Settings for Viewed DVDs 20
- ❑ Changing subtitle language 21
- ❑ Changing audio soundtrack language 21
- ❑ Viewing from another angle 22
- ❑ Repeat Play 23
- ❑ Storing markers in memory to be viewed
(listened to) again 24
- ❑ Zoom Feature 25
- ❑ Sleep Timer Setting 25
- ❑ Program Play 26
- ❑ Playback with MP3 27-28

Radio Operation

- ❑ Presetting the radio stations 29
- ❑ Listening to the radio 30

Sound Operation

- ❑ Selecting a Sound mode 31
- ❑ Enjoying the Surround Effect 32
 - Constituent Elements 32
 - Sound feature in the Room 32
 - Speaker Positioning 32
- ❑ Delay Time Setting 33
- ❑ Setting the Sound Level 34
 - Setting the sound level of the desired channel 34
 - Setting the Balance between each channels
by using the test tone 34

Initial Settings

- ❑ Common procedures of initial settings 35
- ❑ Selecting disc Languages 36
- ❑ Selecting rating level and password 37-38
- ❑ Selecting TV Aspect 39
- ❑ Selecting Menu Language 40
- ❑ Selecting PBC (Playback Control) 40
- ❑ Table of Languages and Their Abbreviations . . . 41

Reference

- ❑ Disc Requirements/Copyright Information 42
- ❑ Before Calling Service Personnel 43-44
- ❑ Specifications 45

Notes on handling

- ❑ When shipping the DVD receiver, always use the original shipping carton and packing materials. For maximum protection, repack the unit as it was originally packed at the factory.
- ❑ Do not use volatile liquids, such as insect spray, near the DVD receiver. Do not leave rubber or plastic products in contact with the DVD receiver for a long time. They will leave marks on the finish.
- ❑ The top and rear panels of the DVD receiver may become warm after a long period of use. This is normal and not a malfunction.
- ❑ When the DVD receiver is not in use, be sure to remove the disc and turn off the power.
- ❑ If you do not use the DVD receiver for a long period, the unit may not function properly in the future. Turn on and use the DVD receiver occasionally.

Notes on Locating

- ❑ When you place this DVD receiver near a TV, radio, or VCR, the playback picture may become poor and the sound may be distorted. In this case, move the DVD receiver away from the TV, radio, or VCR.

Notes on Cleaning

Use a soft, dry cloth for cleaning.

- ❑ For stubborn dirt, soak the cloth in a weak detergent solution, wring well and wipe. Use a dry cloth to wipe it dry. Do not use any type of solvent, such as thinner and benzene, as they may damage the surface of the DVD receiver.
- ❑ If you use a chemical saturated cloth to clean the unit, follow that product's instructions.

Warning: Cleaning and adjustment of lenses and/or other components of playback mechanism should be performed by a qualified service technician.

To Obtain a Clear Picture

The DVD receiver is a high technology, precision device. If the optical pick-up lens and disc drive parts are dirty or worn down, the picture quality becomes poor. To obtain a clear picture, we recommend regular inspection and maintenance (cleaning or parts replacement) every 1,000 hours of use depending on the operating environment. For details, contact your nearest dealer.

Notes on Moisture Condensation

Moisture condensation damages the DVD receiver. Please read the following carefully.

Moisture condensation occurs, for example, when you pour a cold drink into a glass on a warm day. Drops of water form on the outside of the glass. In the same way, moisture may condense on the optical pick-up lens inside this unit, one of the most crucial internal parts of the DVD receiver.

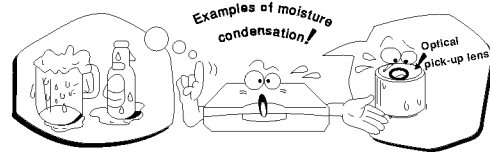

Moisture condensation occurs during the following cases.

- ❑ When you bring the DVD receiver directly from a cold place to a warm place.
- ❑ When you use the DVD receiver in a room where you just turned on the heater, or a place where the cold wind from the air conditioner directly hits the unit.
- ❑ In summer, when you use the DVD receiver in a hot and humid place just after you move the unit from an air conditioned room.
- ❑ When you use the DVD receiver in a humid place.

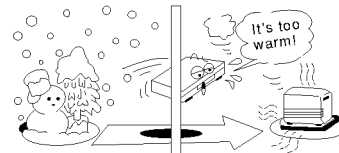

- ❑ **Do not use the DVD receiver when moisture condensation may occur.**

If you use the DVD receiver in such a situation, it may damage discs and internal parts. Remove the disc, connect the power cord of the DVD receiver to the wall outlet, turn on the DVD receiver and leave it "ON" for two or three hours. After two or three hours, the DVD receiver will have warmed up and evaporated any moisture. Keep the DVD receiver connected to the wall outlet and moisture condensation will seldom occur.

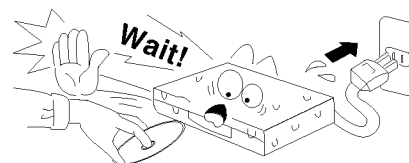

This section shows you how to handle, clean, and store discs.

On Handling Discs

- Do not touch the playback side of the disc.

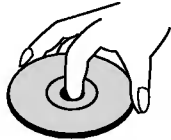

- Do not attach paper or tape to discs.



On Storing Discs

- Do not store discs in a place subject to direct sunlight or near heat sources.
- Do not store discs in places subject to moisture and dust such as a bathroom or near a humidifier.
- Store discs vertically in a case. Stacking or placing objects on discs outside of their case may cause warping.

On Cleaning Discs

- Fingerprints and dust on the disc cause picture and sound deterioration. Wipe the disc from the center outward with a soft cloth. Always keep the disc clean.
- If you cannot wipe off the dust with a soft cloth, wipe the disc lightly with a slightly moistened soft cloth and finish with a dry cloth.
- Do not use any type of solvents such as thinner, benzene, commercially available cleaners or anti-static spray for vinyl LPs. They may damage the disc.

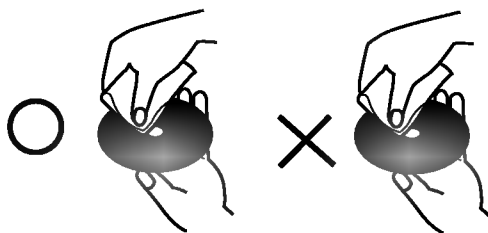

About This Owner's Manual

- This owner's manual explains the basic instructions of this DVD receiver.
- Some DVD video discs have functions that may not be explained in this owner's manual. Therefore, some instructions may differ from this owner's manual, and there may be extra instructions. In this case, follow the instructions displayed on the TV screen or package.
- "⊘" may appear on the TV screen during operation. This icon means the function explained in this owner's manual is not available on that specific DVD video disc.

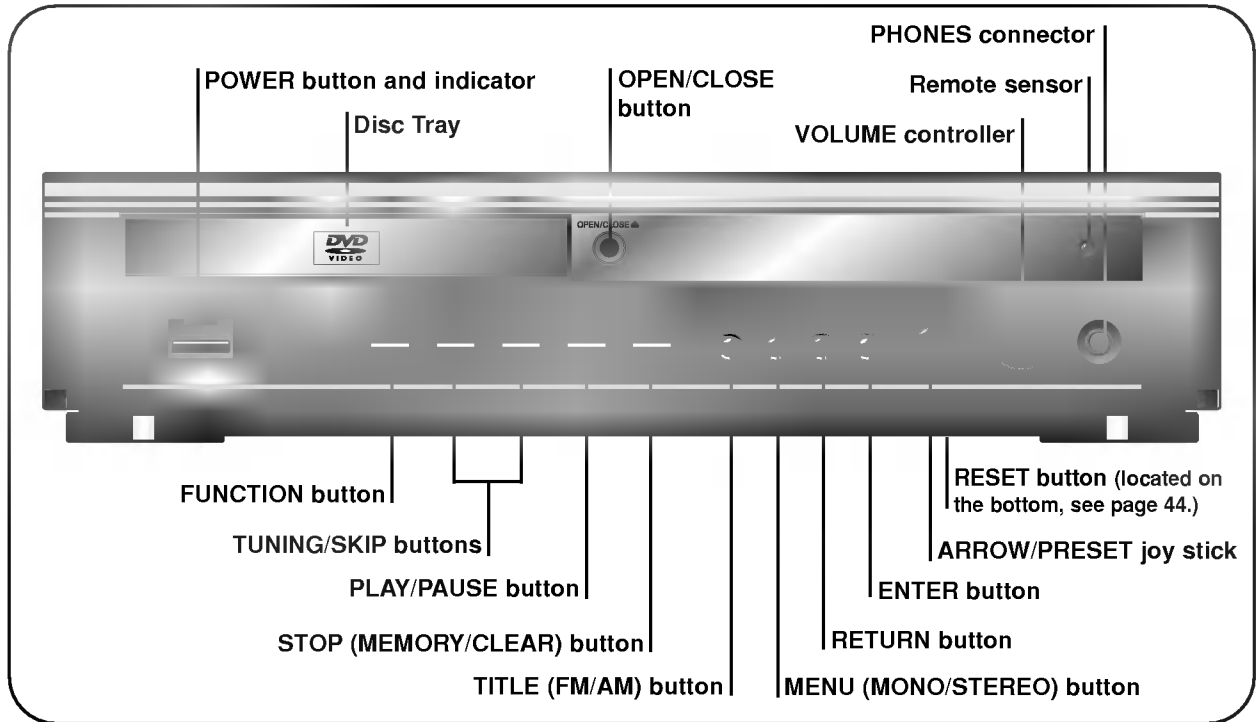

Display Window

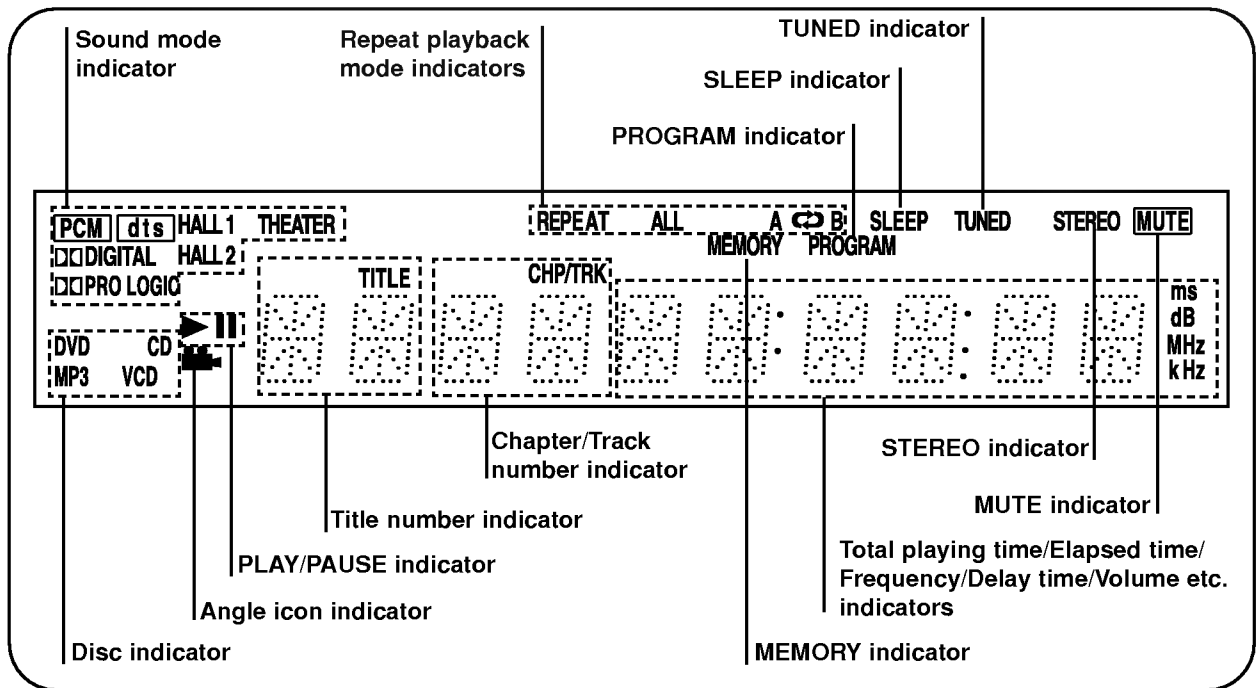

Rear Panel

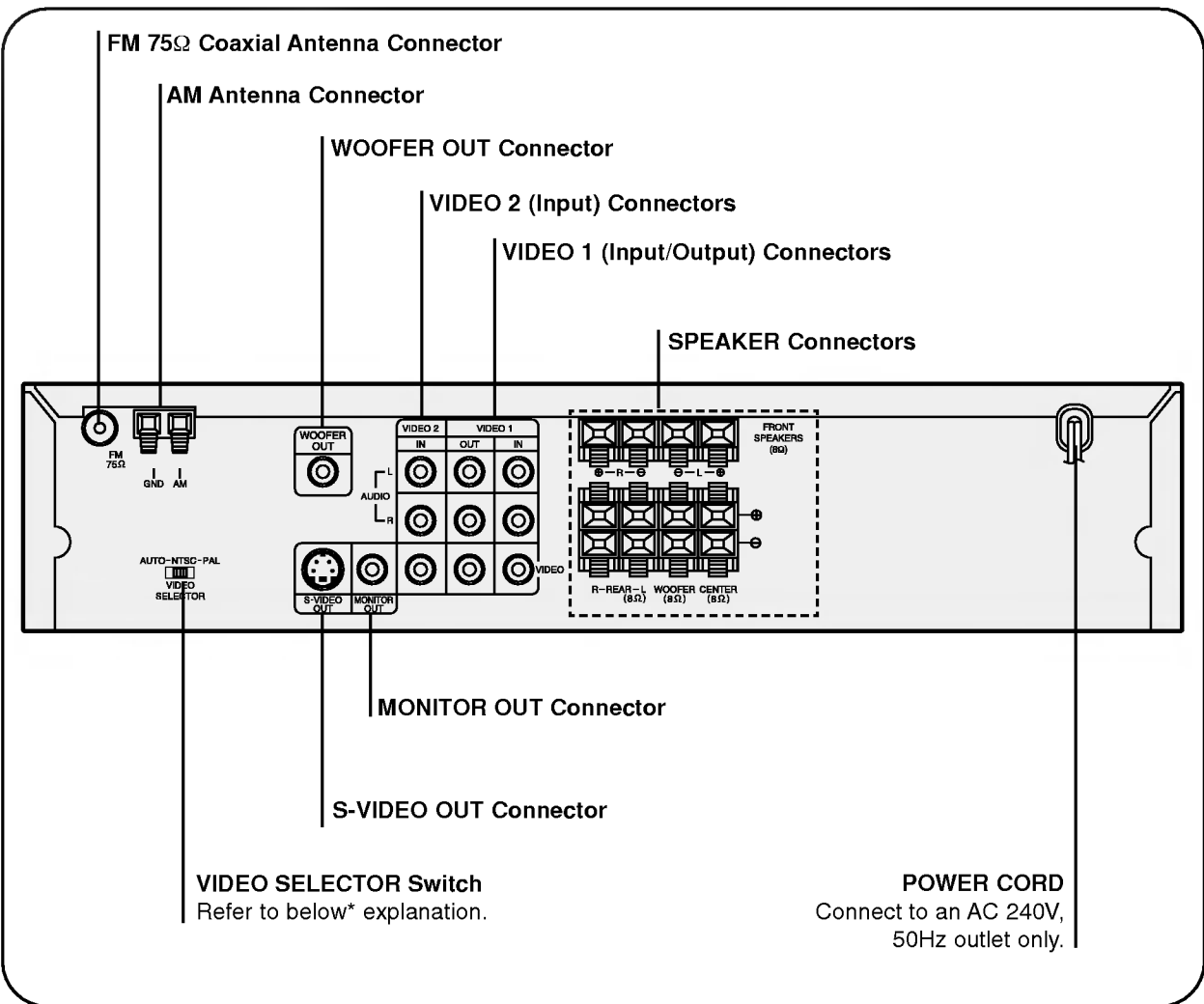

***VIDEO SELECTOR Switch**

You can enjoy NTSC or PAL discs by using your VIDEO SELECTOR switch to choose the appropriate system.

- If you try to play back PAL disc with NTSC-TV. The DVD receiver will not playback the disc.
- When the selected VIDEO SELECTOR switch does not coincide with the system of your TV, normal color picture may not be displayed.
- Adjust the VIDEO SELECTOR switch when the power is turned off.
- When you playback NTSC disc with PAL-TV, some discs may produce black bands at the top and bottom of the screen.

Position of VIDEO SELECTOR switch	Connected TV	Available disc
PAL	PAL	NTSC/PAL DVD disc
NTSC	NTSC	NTSC DVD disc
AUTO	MULTI system TV	NTSC/PAL DVD disc

REMOTE CONTROL

You will find instructions for each of the remote control functions in the appropriate sections of this instruction manual.

POWER button

CD/DVD button

FM/AM button

MUTE button

VIDEO 1 button

VIDEO 2 button

SLEEP button

PRESET (▲/▼) buttons

NUMBER buttons

STOP button

SKIP (*SEARCH) <</>> button

SOUND MODE button

BY PASS button

TEST TONE button

DELAY button

LEVEL button

RETURN button

DISPLAY button

***MENU button**

SET-UP button

SLOW SCAN (<</>>) buttons

VOLUME (▲/▼) buttons

PAUSE/STEP button

PLAY button

REPEAT button

PROGRAM button

****ARROW buttons**

ENTER button

ANGLE button

SUBTITLE button

REPEAT A-B button

ZOOM button

*****TITLE button**

CLEAR button

AUDIO button

MARKER button

SEARCH button

***MENU button**
Use the MENU button to display the menu screen included on DVD video discs. To operate a menu screen, follow the instructions in "Using a DVD Menu" (page 19).

*****TITLE button**
Use the TITLE button to display the title screen included on DVD video discs. To operate a menu screen, follow the instructions in "Using a Title Menu" (page 19).

*** SKIP <</>>**
Press and hold button for about two seconds for search function.

**** Directional arrow buttons**
(up, down, left, right) for use in highlighting a selection on a GUI menu screen, TITLE and MENU screen.

Preparing the Remote Control

Insert the batteries into the remote control so you can use it to operate the DVD receiver.

Open the battery cover.

Insert batteries (AAA size).

- Make sure to match the + and - on the batteries to the marks inside the battery compartment.

Close the cover.

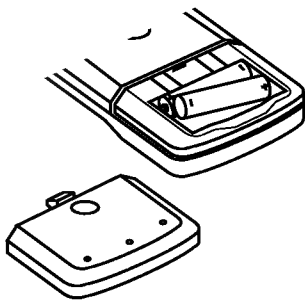

- Improper use of batteries may cause battery leakage and corrosion.
- To operate the remote control correctly, follow the instructions.
- Do not insert the batteries into the remote control in the wrong direction.
- Do not charge, heat, open, or short-circuit the batteries. Do not throw the batteries into fire.
- Do not leave dead or exhausted batteries in the remote control.
- Do not use different types of batteries together, or mix old and new batteries.
- If you do not use the remote control for a long period of time, remove the batteries to avoid possible damage from battery corrosion.
- If the remote control does not function correctly or if the operating range becomes reduced, replace all batteries with new ones.
- If battery leakage occurs, wipe the battery liquid from the battery compartment, then insert new batteries.
- The batteries should last about one year with normal use.

Operating with the Remote Control

This section shows you how to use the remote control.

Point the remote control at the remote sensor and press the buttons.

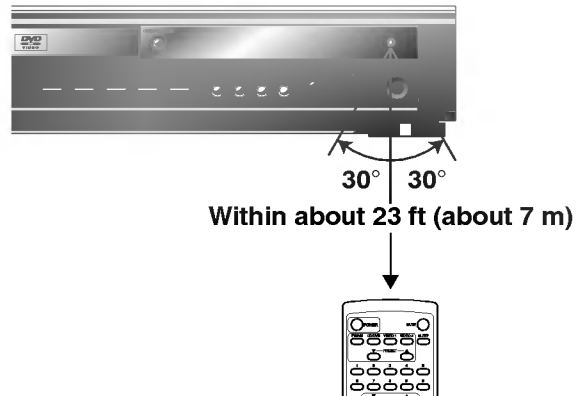

Distance: About 23 ft (7 m) from the front of the remote sensor

Angle: About 30° in each direction of the front of the remote sensor

- * Do not expose the remote sensor of the DVD receiver to a strong light source such as direct sunlight or illumination. If you do so, you may not be able to operate the DVD receiver with the remote control.

- Direct the remote control at the remote sensor of the DVD receiver.
- Do not drop or give the remote control a shock.
- Do not leave the remote control near an extremely hot or humid place.
- Do not spill water or put anything wet on the remote control.
- Do not open the remote control.

Connect the supplied FM/AM antennas for listening to the radio.

- Connect the AM loop antenna to the AM antenna connector.
- Connect the FM wire antenna to the FM 75Ω coaxial connector.

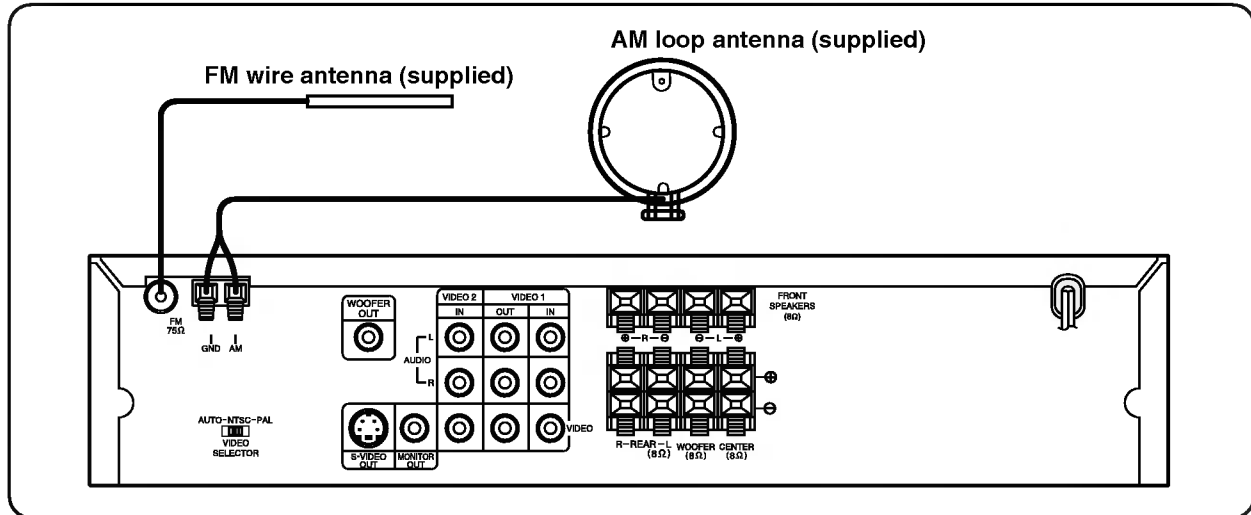

- To prevent noise pickup, keep the AM loop antenna away from the DVD Receiver and other component.
- Be sure to fully extend the FM wire antenna.
- After connecting the FM wire antenna, keep it as horizontal as possible.

Connect the speakers using the supplied speaker cords by matching the colors of the terminals and those of the cords. To obtain the best possible surround sound, adjust the speaker parameters (distance, level, etc.)

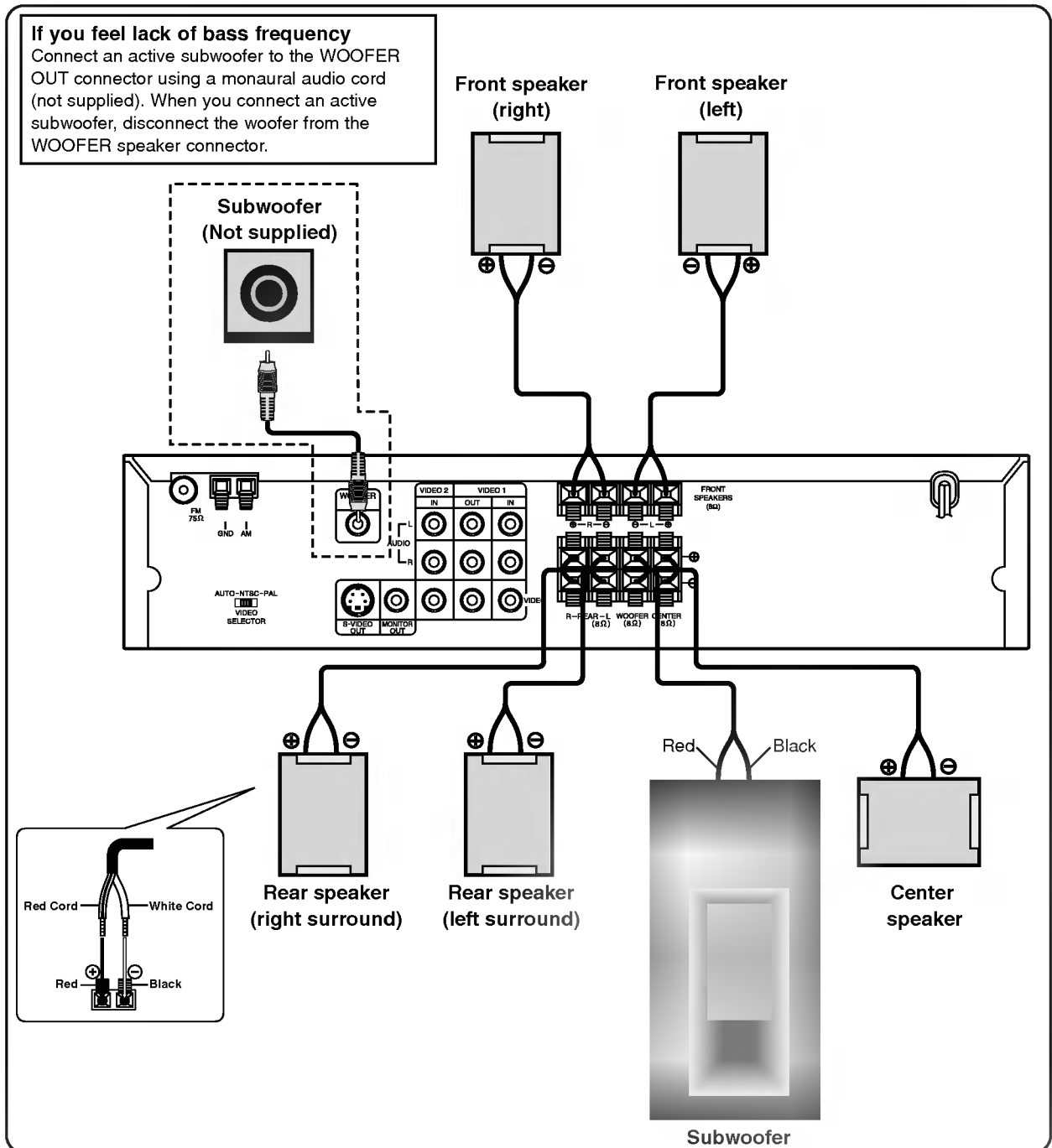

Connect the DVD receiver to your TV and VCR.

- Connect a TV(Monitor) to the MONITOR OUT or S-VIDEO OUT connector.
- Connect a VCR to the VIDEO 1 connectors.
- Connect a additional VCR to the VIDEO 2 connectors.

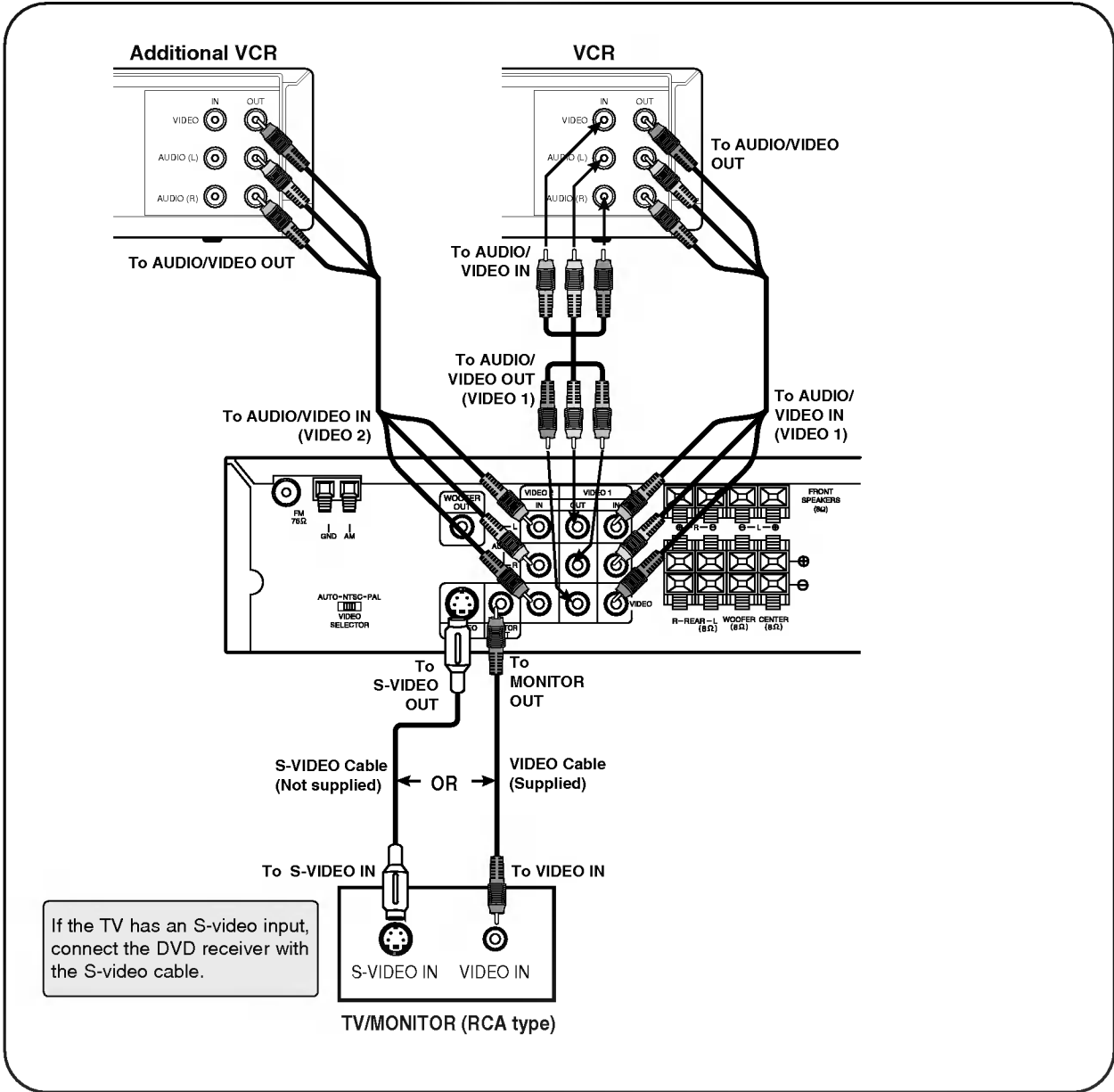

- Refer to the owner's manual of your TV as well.
- When you connect the DVD receiver to your TV, be sure to turn off the power and unplug both units from the wall outlet before making any connections.
- Connect the DVD receiver to your TV directly. If you connect the DVD receiver to a VCR, the playback picture will be distorted because DVD video discs are copy protected.
- The signal of S-VIDEO OUT jack will output only when the function mode is selected to CD/DVD.
- When you select the function mode to VIDEO 1, the signal of VIDEO 1 Output Jacks is not flow out.



This section shows you the basics on how to play back a DVD video disc.

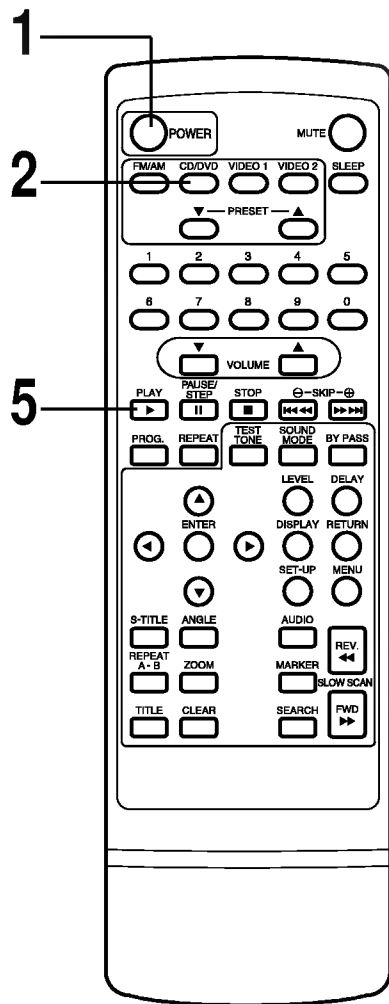
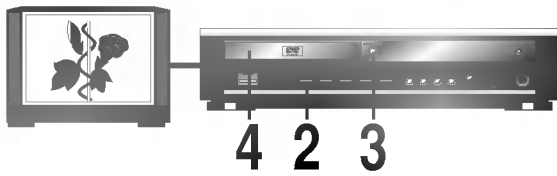

Preparations

- When you want to play back DVD video discs, turn on the TV and select the video input source connected to the DVD receiver.
- When you want to enjoy the sound of DVD video discs or audio CDs from the audio system, turn on the audio system and select the input source connected to the DVD receiver.
- For connection details, see pages 10 through 12.
- Set the playback picture size according to the aspect ratio of the connected TV at the SET-UP menu (TV Aspect).

Press POWER.

The DVD receiver turns on and the display window lights.

Press FUNCTION on the front panel repeatedly or CD/DVD on the Remote control to select the CD/DVD function mode.

Press OPEN/CLOSE.

The disc tray opens.

- You can open the disc tray by pressing this button even if the DVD receiver is in standby mode.

Place a disc on the disc tray with the playback side down.

- There are two different disc sizes. Place the disc in the correct guide on the disc tray. If the disc is out of the guide, it may damage the disc and cause the DVD receiver to malfunction.
- Do not place anything except 3" discs or 5" discs on the disc tray.

Press PLAY.

The disc tray is automatically closed and playback begins.

- If the disc is placed in upside down (and it is a single sided disc), "NO DISC" or "DISC ERROR" appears on the TV screen.
- If you insert an audio CD, the CD indicator lights up in the DVD display. The title number does not appear.
- After playing back all of the chapters in the title, the DVD receiver automatically stops and returns to the menu screen.

When a menu screen appears on the TV screen.

In case of interactive DVDs with control, a menu screen appears on the TV screen. Perform step 6 on page 14 to start play.

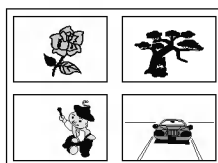

Example of interactive DVD On-Screen Menu

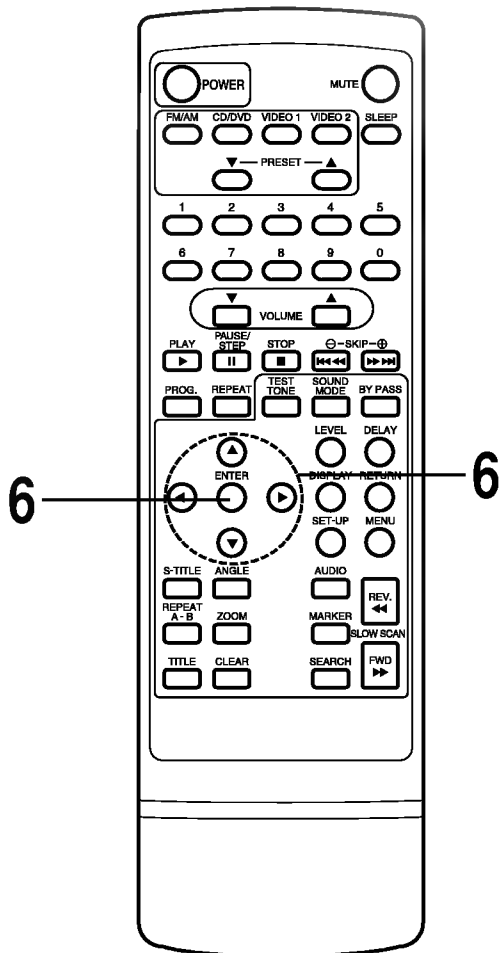

Press ▲/▼/◀▶ and press ENTER, or press the numeric button(s), to select the desired item.

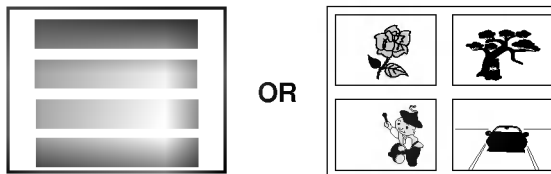

Play of the selected item now begins.

- For further information, also refer to the jacket or case of the disc you are playing.

After operation

When the unit is not in use, remove the disc and press POWER to turn off the DVD receiver.

Video CD
 This contains recordings of pictures and sound whose quality is on a par with that of video tape. This DVD receiver also supports Video CDs with playback control (Version 2.0).

What is playback control (PBC)?
 If a Video CD has "playback control" written on its disc or jacket, it means that particular scenes or information can be selected for viewing interactively with the TV monitor using the menu screen.

- Do not move the DVD receiver during playback. Doing so may damage the disc and the DVD receiver.
- Use the OPEN/CLOSE button on the DVD receiver to open and close the disc tray. Do not push the disc tray while it is moving. Doing so may cause the DVD receiver to malfunction.
- Do not push up the disc tray or put any objects other than discs on the disc tray. Doing so may cause the DVD receiver to malfunction.
- Keep your fingers well clear of the disc tray as it is closing. Be especially careful with children's fingers around the closing disc tray as there is a risk of personal injury.
- When "⊘" appears on the TV screen while a button is pressed, it means that this function is not available on the disc you are playing.
- Depending on the DVD disc, some operations may be different or restricted. Refer to the jacket or case of the disc you are playing.

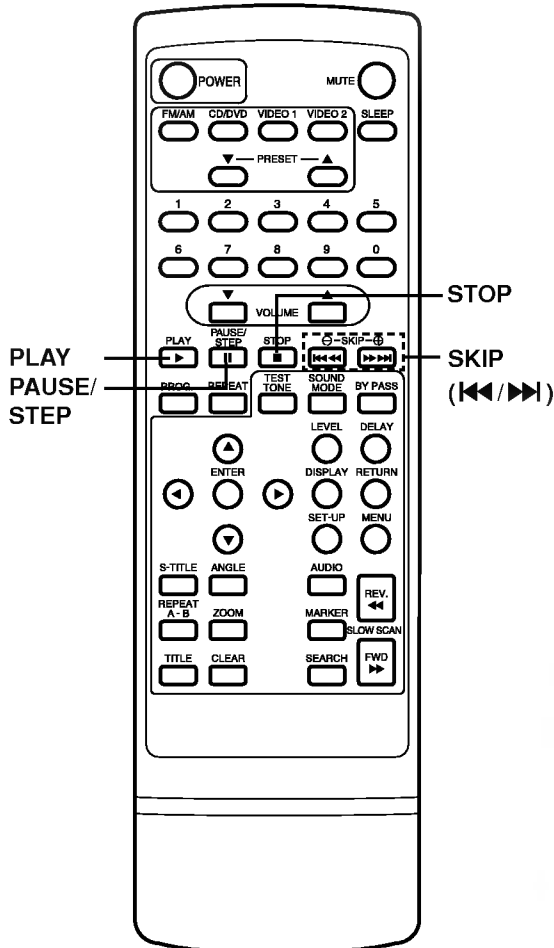

Press STOP during playback.

- When play is stopped, the unit records the point where STOP was pressed (RESUME function). Press PLAY and play will resume from this point.

- Resume function will be cleared when the STOP is pressed on the STOP mode.
- Resume function will be cleared when the power is turned off and then on.
- Opening the disc tray cancels Resume function.
- The Resume function may not be available on some DVD discs or Video CDs (version 2.0).

Press PAUSE/STEP during playback.

- DVD/Video CD
The DVD receiver will be placed in the still picture mode.
- CD
The DVD receiver will be placed in the pause mode.

Frame advance (DVD and Video CD only)

Press PAUSE/STEP during still playback.
(Each time you press PAUSE/STEP, the picture advances one frame)

To resume normal playback, press PLAY.

Skipping chapters and tracks forward or back

Skipping forward

Press SKIP ►► during playback.

A chapter (DVD) or a track (CD/Video CD) is skipped each time the button is pressed.

Skipping back

Press SKIP ◄◄ during playback.

- When the button is pressed once midway through a chapter/track, the DVD receiver returns to the start of that chapter/track. When it is pressed again, a chapter/track is skipped each time the button is pressed.

For your reference:

- When ◄◄ SKIP ►► is pressed during menu play of video CDs equipped with PBC (Version 2.0), a menu screen may sometimes be recalled.



You can play back discs at various speeds.

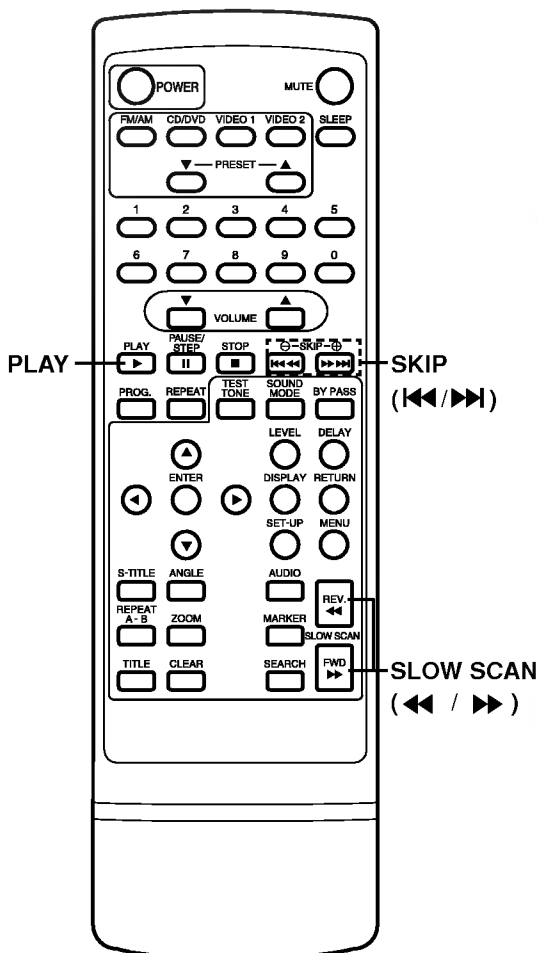

To Scan at fast forward or fast reverse playback.

Press and hold SKIP ◀◀ or ▶▶ button for about two seconds during playback.

[TV screen]



- The speed of advance (reverse) is relatively slow at first. When the button is pressed again, the speed becomes faster. (Each time the button is pressed, the speed increases up to 4 steps (DVD), 3 steps (Video CD) or 1 step (CD).)
- The speed will be retained even after the button is released.

To return to normal playback, press PLAY.

- The DVD receiver does not play back sound during the high speed reverse and forward playback of DVD video discs. However, the DVD receiver plays back sound during fast forward or fast reverse playback of audio CDs.

Playing in slow-motion (DVD and Video CD only)

Press SLOW SCAN ◀◀ or ▶▶ during playback.

The playback speed becomes 1/16 of the normal speed.

[TV screen]



- The speed of slow-motion is slow at first. When the button is pressed again, the speed becomes faster. (Each time the button is pressed, the speed increase up to 4 steps (DVD) or 3 steps (Video CD).)
- The speed will be retained even after the button is released.

To return to normal playback, press PLAY.

- The sound is muted during slow-motion playback.
- Subtitles do not appear on the screen during slow motion playback.
- The SLOW SCAN buttons do not work with Audio CDs.
- The reverse slow does not work in case of Video CD.

This unit features GUI Menu Icons showing disc information (title/chapter/track number, elapsed playing time, audio/subtitle language, angle, and sound) and DVD receiver information (repeat play, play mode, marker, etc.). Some icons only show the indicated information. Other icons allow the settings to be changed.

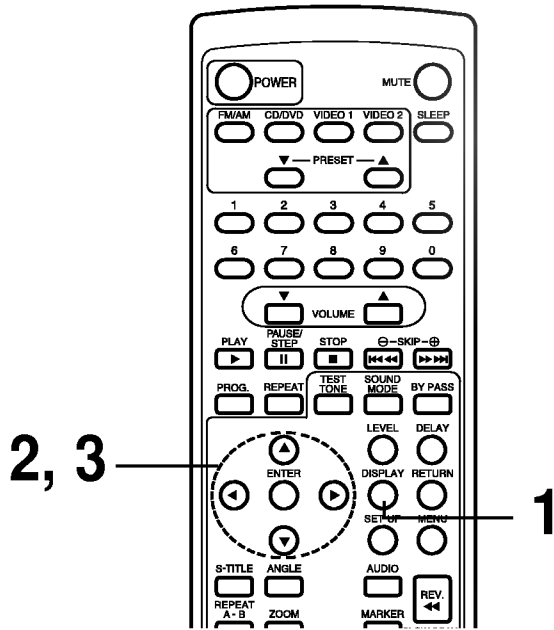

Common procedures

Press DISPLAY during playback.

- Title function can be accessed from the stop mode.

Press ▲/▼ to select the desired item.

- The current selected item is indicated by a yellow frame on its GUI menu icons.

Press ◀/▶ to select the desired setting.

- When numbers are displayed (e.g. title number), the numeric buttons can also be used for setting instead of ◀/▶.
- For some functions, the setting will be registered immediately; for others, ENTER must be pressed.

To clear the GUI Menu Icons, press DISPLAY again.

Examples of GUI Menu Icons.

(The screens may differ depending on the disc contents.)



(DVD GUI)

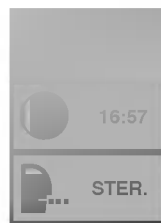

(CD/Video CD GUI)



(Video CD (Version 2.0))

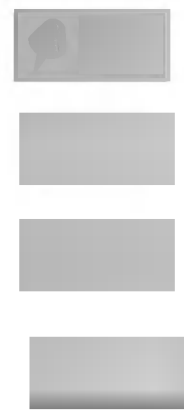

(DVD and CD GUI)



You can view information about a disc and its operational status on the TV screen.

Press DISPLAY during playback.
[TV screen] DVD GUI



FUNCTION (Press ▲/▼ to select desired item)	SELECTION METHOD
To show the current title number and to jump to the desired title number	◀▶, or Numeric ENTER
To show the current chapter number and to jump to the desired chapter number	◀▶, or Numeric ENTER SKIP
To show the elapsed time and directly select scenes by the desired time.	Numeric ENTER
To show the current audio soundtrack language, encoding method, channel number and to change the settings.	◀▶, AUDIO
To show the current subtitles language and to change the setting.	◀▶, S-TITLE
To show the current angle number and to change the angle.	◀▶, ANGLE

Press DISPLAY during playback.
[TV screen] CD/Video CD GUI



FUNCTION (Press ▲/▼ to select desired item)	SELECTION METHOD
To show the current track number and to jump to the desired track number	◀▶, or Numeric ENTER SKIP
To show the elapsed time. (Display only)	—
To show the current audio (STEREO, LEFT, RIGHT) and to select to the desired audio channel.	◀▶, AUDIO

- Some DVD discs may not provide all of the above GUI menu icons.
- Video CDs (version 2.0) may not provide TRACK icon.



Some movie discs may contain two or more titles. If the disc has a title menu recorded on it, the TITLE button can be used to select the movie title. (The details of operation differ depending on the disc used.)

- Selecting a title may not be possible on certain DVD discs.

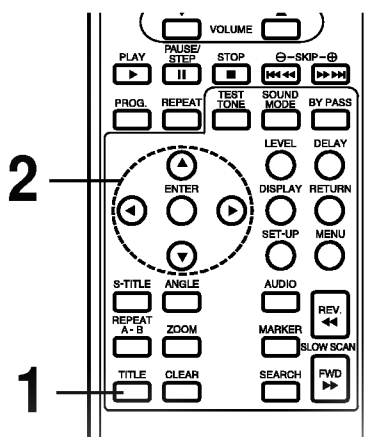

Press TITLE.

A list of the titles on the disc is displayed.

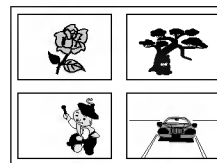

Pressing TITLE again to resume play from the scene when TITLE was first pressed.

- Resume play may not be possible on certain discs.

Press ▲/▼/◀/▶ and press ENTER or PLAY, or press the numeric button(s), to select desired title.

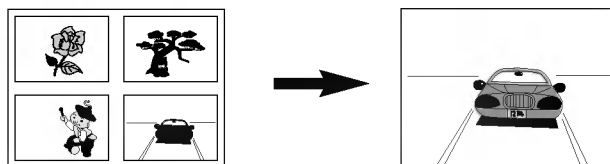

The selected title now starts playing.



Some DVDs have unique menu structures called DVD menus. For example, DVDs programmed with complex contents provide guide menus, and those recorded with various languages provide menus for audio and subtitle language. Although the DVD menu's contents and operation differ from disc to disc, the following explains the basic operation when this feature is used.

Press MENU during play.

The DVD menu available on the disc is now displayed.

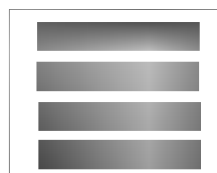

Pressing MENU again resumes play from the scene when MENU was first pressed.

- Resume play may not be possible on certain discs.

Press ▲/▼/◀/▶ and press ENTER, or press the numeric button(s), to select desired item.

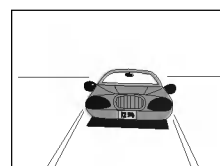
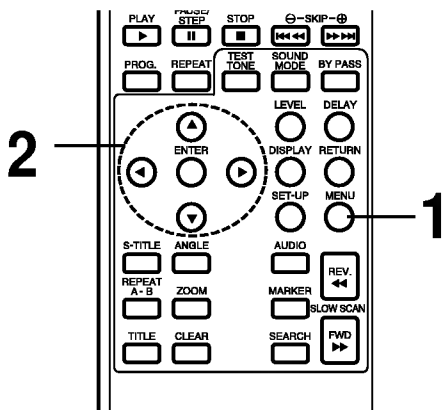

The selected item is now executed.



This unit stores, in memory, settings for the last DVD you have watched. Settings remain in memory even if you remove the disc from the DVD receiver, or switch power to OFF. If you load a disc that has its settings memorized, the "Resume disc from last position?" message will appear on the TV screen. When you start playing the disc, the memorized settings are automatically recalled.

You can memorize details for the following six settings.
Last Stop Position (Page 15)
TV Aspect (Page 39)
Disc Subtitle Language (Page 21, 36)
Disc Audio Language (Page 21, 36)
Disc Menu Language (Page 36)
Angle (Page 22)

Load the DVD that was memorized.

- It will appear on the TV screen as below
- If the screen is left for more than 10 seconds, playback will start from the beginning of the title automatically.

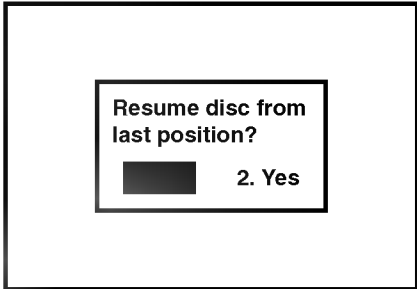
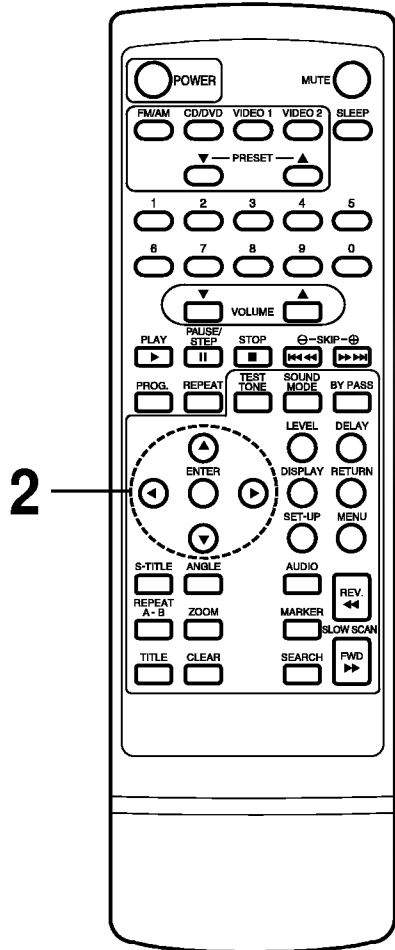

- Press ◀▶ to select "Yes" and press ENTER.**
 The memorized settings are automatically recalled.

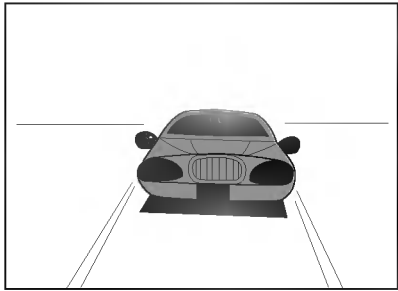

- Settings are stored in memory for use any time.
- You can store settings for up to 1 DVD in memory. If you memorize settings for more than 1 DVD previously memorized settings are erased in order from the last memorized settings. Subsequently, if you try to call up these previously memorized settings, you will get the latest settings that have taken their place.
- Switching of the audio mode etc., is automatic on some discs.
- This unit does not store settings in memory, if you remove the disc from the DVD receiver or switch power to the DVD receiver OFF when DVD or title menu is displayed on the TV screen.



It is possible to change the subtitle language to a different language from the one selected at the initial settings. (See page 36 for further info.)

This operation works only with discs on which multiple subtitle languages are recorded.

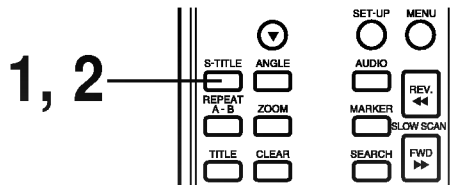

- In some cases, the subtitle language is not changed to the selected one immediately.
- When a disc supporting the closed caption is played, the subtitle and the closed caption may overlap each other on the TV screen. In this case, turn the subtitle off.
- When the desired language is not selected even after pressing the button several times, it means that the language is not available on the disc.
- When the power is turned on or the disc is removed, subtitles appears in the language selected at the initial settings. If this language is not recorded on the disc, the disc's priority language appears.

Press S-TITLE during playback.
When no subtitles are recorded, "OFF" will be displayed instead of the language number.



Press S-TITLE repeatedly until the desired language is selected.
Number of the subtitle language being played back is shown.



To eliminate the On Screen Subtitles.
Press S-TITLE repeatedly to select OFF at step 2.



It is possible to change the audio soundtrack language (or encoding method, channel number) to a different language from the one selected at the initial settings in case of DVD disc. (See page 36 for further info.) This operation works only with discs on which multiple audio soundtrack languages are recorded.

And it is possible to change the audio channel in case of audio CD.

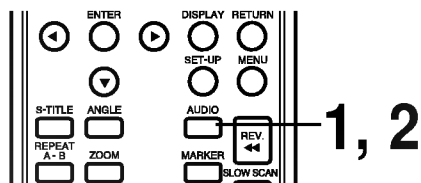

- When the desired language is not selected even after pressing the button several times, it means that the language is not available on the disc.
- When the power is turned on or the disc is removed, the language heard is the one selected at the initial settings. If this language is not recorded on the disc, only the available language on the disc will be heard.
- Some discs may not respond to Audio feature.

• DVD
Press AUDIO during play.
Number of the audio soundtrack language being played back.



Press AUDIO repeatedly until the desired language (or encoding method, channel number) is selected.



• CD/Video CD
Press AUDIO during play.
Press AUDIO repeatedly until the desired sound is selected.





Some DVDs may contain scenes which have been shot simultaneously from a number of different angles. For these discs, the same scene can be viewed from each of these different angles using the ANGLE button. (The recorded angles differ depending on the disc used.)

Press ANGLE during playback.

Number of angle being played back.

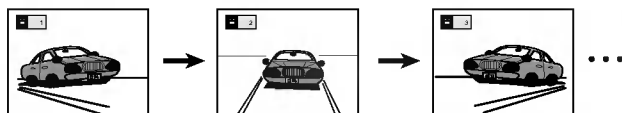

Press ANGLE repeatedly until the desired angle is selected.



For your reference

- The ANGLE indicator will blink in the display window at scenes recorded at different angles to indicate that angle switching is possible.
- The angle number can be programmed beforehand; the angle will be switched to the selected number when the ANGLE indicator blinks.



- This function only works for discs having scenes recorded at different angles.

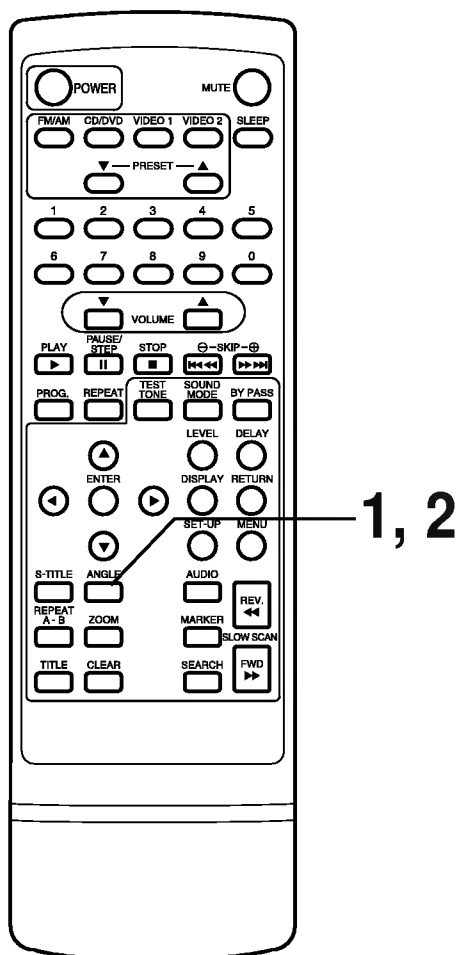



Repeating viewing (listening)

Press REPEAT during playback.

Each time this button is pressed, the TV screen changes as shown below and the disc will repeat a chapter or title (DVD) or a track (CD/Video CD).

• DVD

Repeat of chapter being played

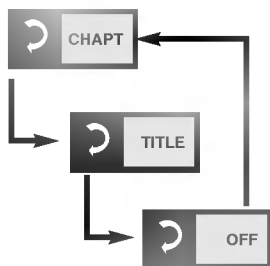

Repeat of title being played

Cancel repeat mode (normal play)

• CD/Video CD

Repeat of track being played

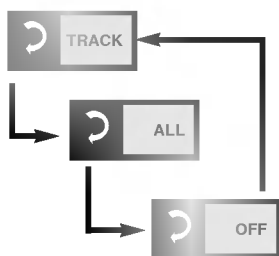

Repeat of entire disc contents

Cancel repeat mode (normal play)

To enjoy program repeat play (CD/Video CD)

If REPEAT is pressed during program play, repeat play is operated as below.

Repeat of the current programmed track

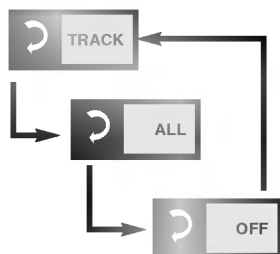

Repeat of all programs

Cancel repeat mode (Program play)

To return to normal play

Press REPEAT several times until "OFF" is displayed.

Repeating sections between two specific points (A-B repeat)

Press REPEAT A-B during play at the point where repeat play is to start (A).



- You can select "OFF" at this step by pressing CLEAR.

Press REPEAT A-B during play at the point where repeat play is to be concluded (B).



Repeat play of the selection between points A and B starts.

To return to normal play

Press REPEAT A-B once "OFF" is displayed.



- Repeat play works only with discs for which the elapsed playing time appears in the display window during playback.
- Repeat play may not work correctly with some DVDs and some Video CDs.
- A-B repeat play works only within a title DVD or a track CD/Video CD.
- Some subtitles recorded around point A or B may fail to appear (DVD).



Storing a MARKER in the DVD memory is similar to marking your page in a book. It allows you to quickly return to any point on the disc.

Storing a marker in the memory

- Press **MARKER** during play at the starting point to be viewed (listened to) again.



Indicates "1/5" is stored in the memory. Up to 5 markers can be stored in the memory.

Recalling/Clearing a marker

- Press **SEARCH** during playback.

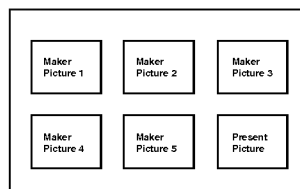

- Press **▲/▼/◀/▶** to select the marker to be recalled/cleared.
- Press **PLAY** or **ENTER** to recall a marker. Or press **CLEAR** to clear a marker.

Play resumes from the point corresponding to the selected marker, or the selected marker is cleared.

- The "Present Picture" is not cleared.

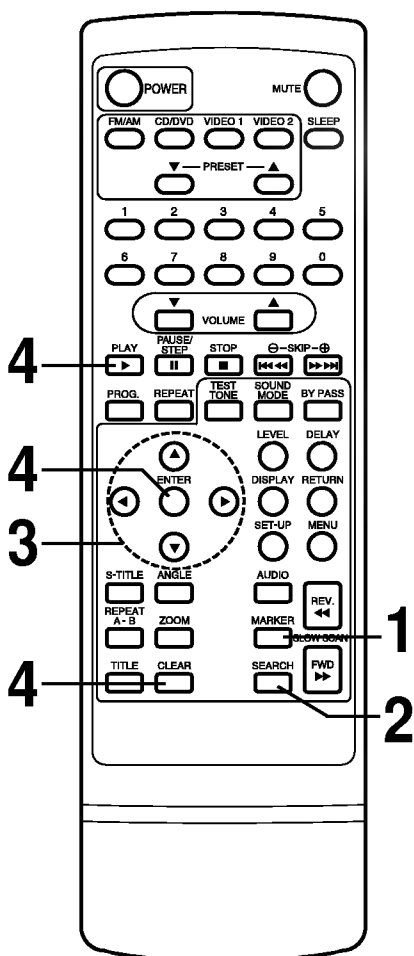

- These operations work only with discs for which the elapsed playing time appears in the display window during playback or stop.
- Some subtitles recorded around the marker may fail to appear (DVD).
- All the markers are cleared when the power is turned off or the disc is removed and when TV Aspect mode is changed on the SET-UP menu.
- The marker is not stored when the DVD or title menu is displayed on the TV screen.



The Zoom feature allows you to “ZOOM-IN” and enlarge the picture on the screen to either 4 times (X4) or 16 times (X16) its normal size.

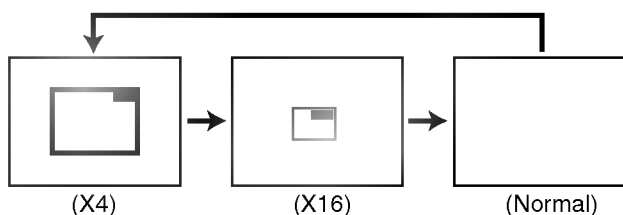
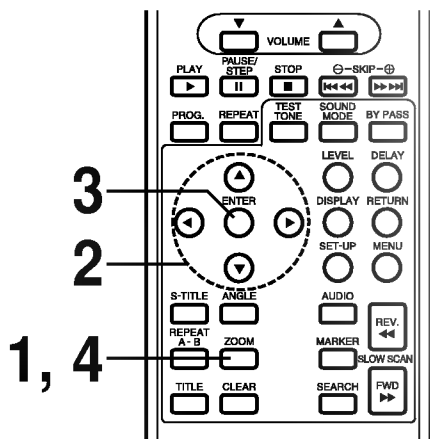

Press ZOOM during normal playback or still playback.

- The square frame will be displayed in the centre of the picture. If no button is pressed for more than 10 seconds, the square frame will disappear.
- Each press of the ZOOM button changes the TV screen in the left sequence.
- The magnification level will be displayed in the upper right corner of the zoom area.

If you press ▲/▼/◀▶ buttons, the zoom point shifts.

Press ENTER.

The selected frame is displayed in full size on the TV screen.

To resume normal playback.

Press ZOOM repeatedly until the normal picture appears.

- Some discs may not respond to the Zoom feature.
- Zoom does not work on subtitles or menus included on DVD video discs.

You can set the DVD receiver to turn off automatically at a specified time.

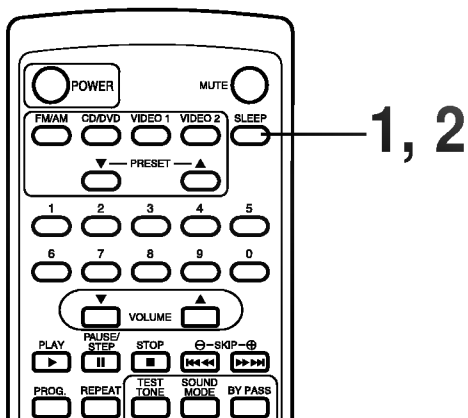

Press SLEEP to set the desired sleep time.

The SLEEP indicator and sleep time appears in the display window.

Each time you press SLEEP, it is changed as the following order.

SLEEP 120 → 90 → 60 → 30 → OFF → 120

For your reference

- You can check the time remaining before the DVD receiver turns off. Press SLEEP. The remaining time appears in the display window.



The DVD receiver plays the tracks on the disc in the order you specify.

Note: Program play function is possible only with audio CDs. It does not work with DVD movie discs and Video CDs (Version 2.0).

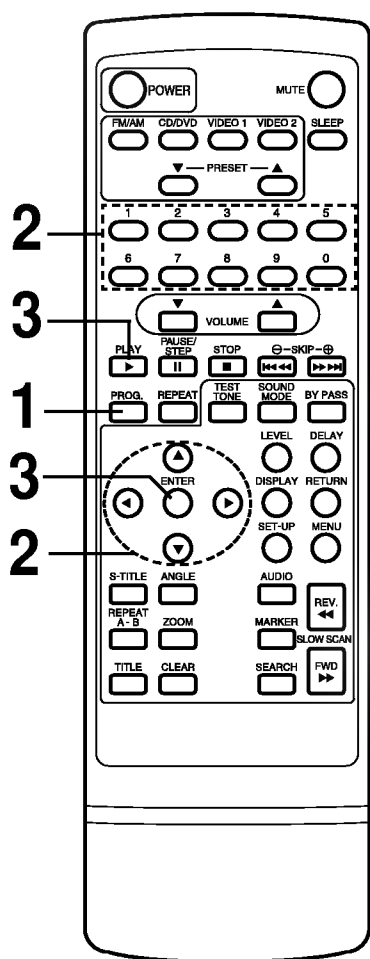

Press PROGRAM during playback or stop mode.

The program playback screen appears on the TV screen.

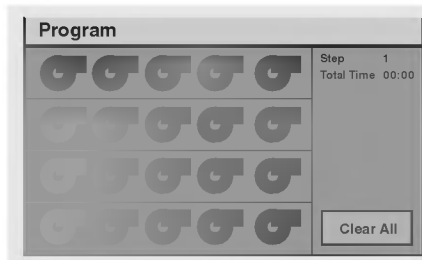

- To exit the screen, press PLAY or PROGRAM.

Press ▲/▼/◀/▶ and press the numeric button(s), to select the desired track number.

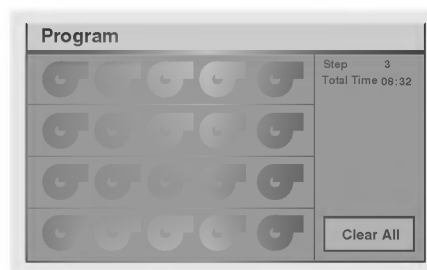

- Repeat step 2 to select another track.
- Up to 20 tracks can be programmed.

Press PLAY or ENTER to exit the screen.

The selected track is stored in the memory and play now begins in the programmed sequence.

- If you press PROGRAM to exit the screen, the selected tracks are not memorized.

After playback of all tracks programmed

Play is stopped.

Clearing the program

• To clear the programmed tracks one by one

Press ▲/▼/◀/▶ to select the unwanted number and then press CLEAR.

• To clear all the programmed tracks

Press ▲/▼/◀/▶ to select "Clear All" and then press ENTER. Press PLAY or ENTER to exit the screen. If you press PROGRAM to exit the screen, the programs are not cleared. (The programs are also cleared when the power is turned off or the disc is removed.)

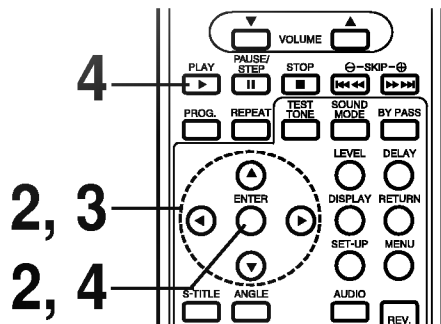

To play an MP3 file

- Load an MP3 disc.
The MP3 menu is displayed.

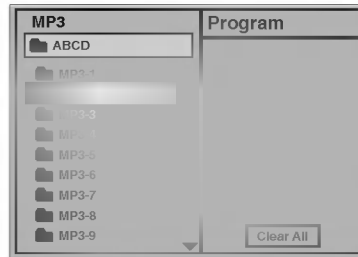

- Press ▲/▼ buttons to select the directory where MP3 files that you want to play are located and then press ENTER.

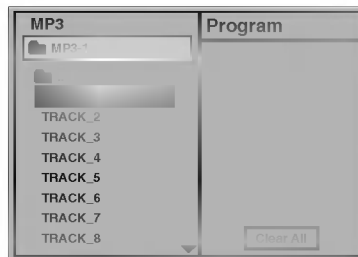

- Press ▲/▼ button to select the desired MP3 file of the selected directory on your disc.

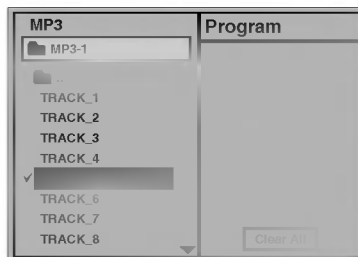

If you want to return to the previous menu, press the RETURN button.

- Press ENTER or PLAY to start playback of the file.

For your reference

- Press SKIP▶▶ or SKIP◀◀ to play the next file or previous file during playback.
- Press TITLE to move to 1st page of current directory during playback and press TITLE again to move to the next page within 5 seconds.
- Press MENU to move to the Root Directory during playback.

To play an MP3 file repeatedly

- If you press REPEAT button once during play, the current MP3 file will play repeatedly.
- If you press REPEAT button twice during play, the directory will play repeatedly.
- If you press REPEAT button three times, the repeat play will be cancelled.

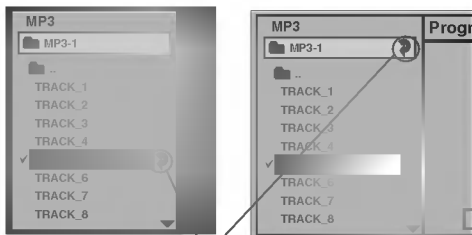

REPEAT symbol

- The directory and file name is only displayed in English.
- If there is an impossible code to display, it will be displayed underlined (_) instead of English.
- If a directory has no MP3 file, the "⊘" is displayed with the directory name.
- This unit can play up to 256 files per disc. A disc recorded with more than 256 files cannot be played.
- The maximum allowable depth of nested directory is 50.
- Disc format is compatible with ISO9660 only.
- If you record mp3 files using the software which cannot create a FILE SYSTEM, for example "Direct-CD" etc., it is impossible to playback mp3 files. We therefore recommend that you use "Easy-CD Creator", which creates an ISO9660 file system.
- A single session disc requires mp3 files in the first track. If there is no mp3 file in the 1st track, it cannot playback mp3 files. If you wish to playback mp3 files, format all the data in the disc or use a new one.
- If there are already data files which are not mp3 files on the CD-R disc, please, do not use that disc; use a new one instead. However, if the disc is a CD-RW disc, this does not apply.

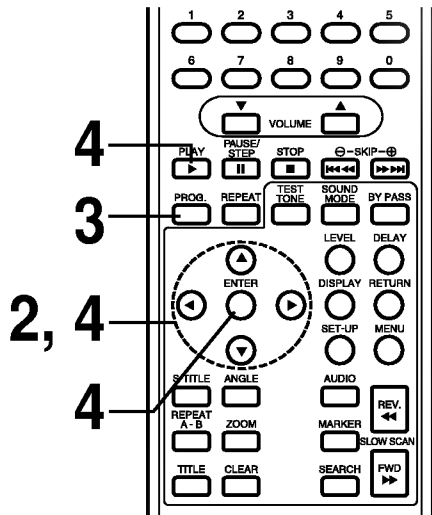

To program play an MP3 file

- Follow steps 1 to 2 on previous page.
- Select an MP3 file to program with ▲/▼.

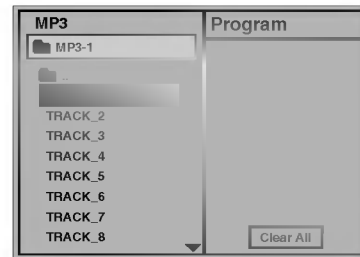

- Press PROGRAM button to add an MP3 file to the program list.

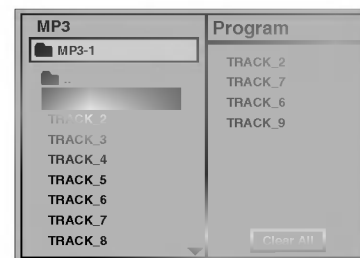

- Repeat steps 2 - 3 to select another track.
- Up to 60 files can be programmed.

- Press ► button and select the desired MP3 file and press ENTER or PLAY button to play.

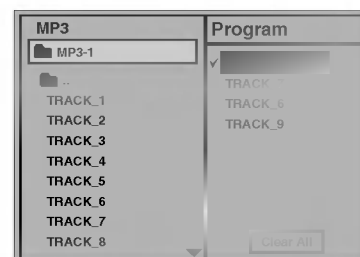

If you want to enter the main menu, press ◀ button.

To play an MP3 file repeatedly

- If you press REPEAT button once during play, the current MP3 file will play repeatedly.
- If you press REPEAT button twice during play, the all MP3 files on the program list will play repeatedly.
- If you press REPEAT button three times, the repeat play will be cancelled.

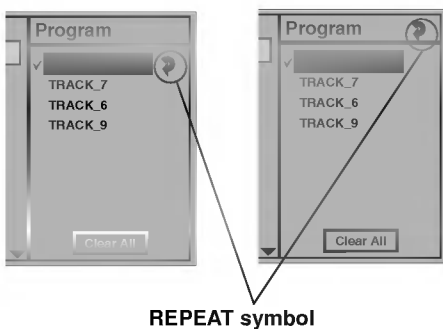

REPEAT symbol

Clearing the program

- To clear the program one by one**
Press ▲/▼/◀/▶ to select the unwanted MP3 file on the program list and then press CLEAR.
- To clear all the programs**
Press ▲/▼/◀/▶ to select the "Clear All" and press ENTER.

After all programmed tracks are played

Play is stopped.

You can preset 30 stations for FM and AM. Before tuning, make sure that you have tuned down the volume to the minimum.

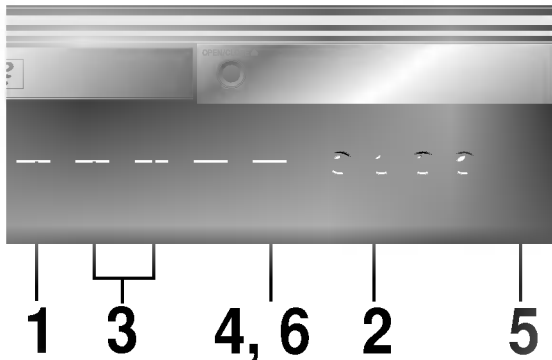

Press **FUNCTION** on the front panel repeatedly or **FM/AM** on the Remote control until the **FM** or **AM** appears in the display window.

And then every time you press **FM/AM**, **FM** and **AM** changes alternately.

Press and hold **TUNING/SKIP** **◀** or **▶** on the front panel for about two seconds until the frequency indication starts to change, then release.

Scanning stops when the DVD Receiver tunes in a station. "TUNED" and "STEREO" (for stereo program) appear in the display window.

Note: TUNED is only appeared when the signal is FM and STEREO.

Press **MEMORY**.
A preset number will flash in the display window.

Press **▲** or **▼** on the front panel to select the preset number you want.

Press **MEMORY** again.
The station is stored.

Repeat steps 3 to 6 to store other stations.

To tune in a station with a weak signal

Press **TUNING/SKIP** **◀** or **▶** repeatedly in step 3 to tune in the station manually.

To clear all the memorized stations

Press and hold **MEMORY** for about three seconds and "CLEAR ALL" is appeared in the display window and then press **MEMORY** again, the stations are cleared.

For your reference

If all stations have already been entered, **MEM FULL** message will appear in the display window for a moment and then a preset number will flash. To change the preset number, follow the steps 5-6 as above.

Preset radio stations in the DVD receiver's memory first (see "Presetting radio stations" on the previous page).

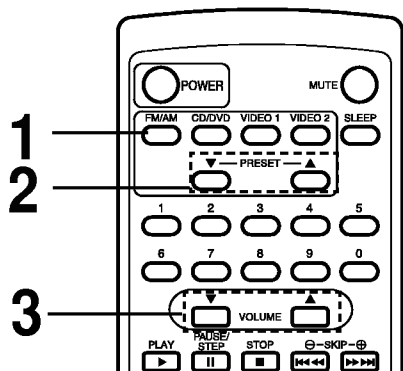

For your reference

- **If an FM program is noisy**
Press MONO/ST. on the front panel so that "STEREO" disappears in the display window. There will be no stereo effect, but the reception will improve. Press the button again to restore the stereo effect.
- **To improve reception**
Reorient the supplied antennas.

Press FM/AM until AM or FM appears in the display window.

The last received station is tuned in.

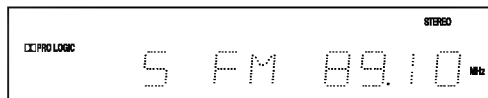

Press PRESET ▲ or ▼ repeatedly to select the preset station you want.

Each time you press the button, the DVD receiver tunes in one preset station at a time.

Adjust the volume by rotating VOLUME on the front panel or pressing VOLUME ▲ or ▼ repeatedly.

To turn off the radio

Press POWER to turn the DVD receiver off or select another function mode (DVD/CD, VIDEO 1 or VIDEO 2).

To listen to non-preset radio stations

- Use manual or automatic tuning in step 2.
- For manual tuning, press TUNING/SKIP ◀◀ or ▶▶ on the front panel repeatedly.
- For automatic tuning, press and hold TUNING/SKIP ◀◀ or ▶▶ for about two seconds on the front panel.

You can enjoy surround sound simply by selecting one of the pre-programmed sound fields according to the program you want to listen to.

Press **SOUND MODE** repeatedly until the sound mode you want appears in the display window.

See the table below for information on each sound mode.

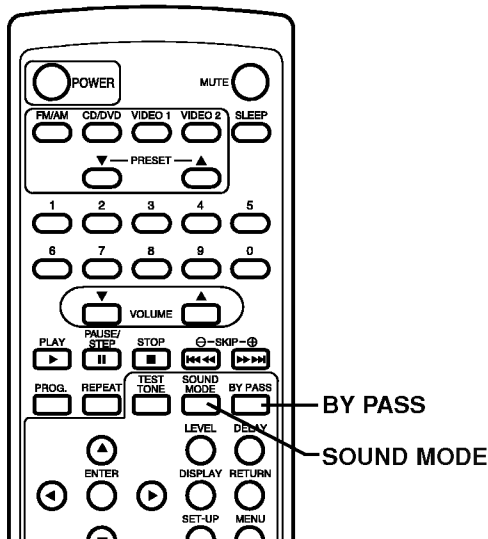

For your reference

- The DVD Receiver memorizes the last sound mode selected for each program source.

Whenever you select a program source, the sound mode that was last applied is automatically applied again. For example, if you listen to CD with HALL1 as the sound mode, change to a different program source, then return to CD, HALL1 will be applied again. With the tuner, sound fields are memorized separately for all preset station.

- You can identify the encoding format of program software by looking at its packaging.



- Dolby Digital discs are labeled with the logo.
- Dolby Surround encoded programs are labeled with the logo.
- DTS Digital Surround discs are marked with DTS.

○ When you play sound tracks with 96 kHz sampling frequency, the output signals will be converted to 48 kHz (sampling frequency).

Sound Mode	Effect
	Allows you to enjoy 5.1(or 6) discrete channels of high quality digital audio from DTS program sources bearing the trademark such as discs, DVD and compact discs, etc. DTS Digital Surround delivers up to 6 channels of transparent audio(which means identical to the original masters) and results in exceptional clarity throughout a true 360 degree sound field. The term DTS is a trademark of DTS Technology, LLC. Manufactured under license from DTS Technology, LLC.
	The Dolby Digital surround format lets you enjoy up to 5.1 channels of digital surround sound from a Dolby Digital program source. If you play DVD of laser discs with “” mark, you can enjoy even better sound quality, greater spatial accuracy, and improved dynamic range. This is because Dolby Digital delivers up to 5 totally discrete, audio channels (front left and right, center, and rear left and right), plus 0.1 channel called LFE*(bass-only effects channel) *LFE=Low Frequency Extension. This channel delivers separate non-directional bass signals to the subwoofer for more dynamic deep bass sound effects.
	Use this mode when playing movie or Dolby Digital 2 channel which carries the “” mark. This mode provides the effect of being in a movie theater or live concert house-an effect with an intensity which can only be obtained through DOLBY PRO LOGIC SURROUND. The effect of the front/back/left/right movement of the sound image, as well as the sense of fixed position in the sound image, is much clearer and more dynamic than before.
HALL 1	When playing recordings of live music and classic, this mode provides a feeling similar to actually being in a small concert hall.
HALL 2	When playing recordings of live music and classic, this mode provides a feeling similar to actually being in a large concert hall.
THEATER	This mode provides a three dimensional effect similar to that of movie theater.
2CH STEREO	Outputs the sound from the front left and right speakers and subwoofer. Standard two channel (stereo) sources completely bypass the sound field processing. This allows you to play any source using only the front left and right speakers and subwoofer. You can select 2CH STEREO by pressing BY PASS on the remote control.



DTS Digital Surround, Dolby Digital and Dolby Pro Logic are used to enjoy the 3-dimensional sound effect with video image. And you need to use the devices as the following.

- Use the Hi-Fi Stereo VCR to play the program sources.
- Use the large sizes TV monitor for high quality video image.
- Use the program sources (e.g. LD, DVD, VIDEO TAPE etc.) marked with DTS Digital Surround () or Dolby Surround ( or ).

Manufactured under license from Dolby Laboratories. "Dolby", "Pro Logic", and the double-D symbol are trademarks of Dolby Laboratories. Confidential Unpublished works. Copyright 1992-1997 Dolby Laboratories. All rights reserved.

Manufactured under license from Digital Theater Systems, Inc. US Pat. No. 5,451,942 and other worldwide patents issued and pending. "DTS" and "DTS Digital Surround" are trademarks of Digital Theater Systems, Inc. Copyright 1996 Digital Theater Systems, Inc. All rights reserved.



If the room is made of concrete and thin woods, you cannot enjoy the sufficient surround effect. The wall of the room must have the appropriate absorption factor and a little sound reflection effect. If the room has the much reflection effect, replace the furniture and you need to hang a curtain etc.



In the case of normal position use the 6 speakers (2 front speakers, center speaker, 2 rear speakers and subwoofer). If you want to play the excellent bass sound, DTS digital surround or Dolby Digital surround, you should connect a subwoofer.

• **Front speakers**

We recommend that the height of the tweeter of the front speakers and listener's ears are same height. And by hearing position set up the interval between speakers to 45 degree.

• **Center speaker**

It is ideal that the center speakers and front speakers are same height. But in normally place it above or below the television.

• **Rear speakers**

Place left and right behind the listening area. These speakers recreate sound motion and atmosphere. Required for surround playback. For best results, do not install the rear speakers too far behind the listening position and install them at or above the level of the listener's ears. It is also effective to direct the rear speakers towards a wall or ceiling to further disperse the sound.

In case of the small sizes from the front to rear of the room, if the listener is near the rear wall set the rear speakers opposite each other, and set the rear speakers above 60-90 cm than the listener's ears, and set up it looks down.

• **Subwoofer**

Without notice for the setting position place it an appropriate position.

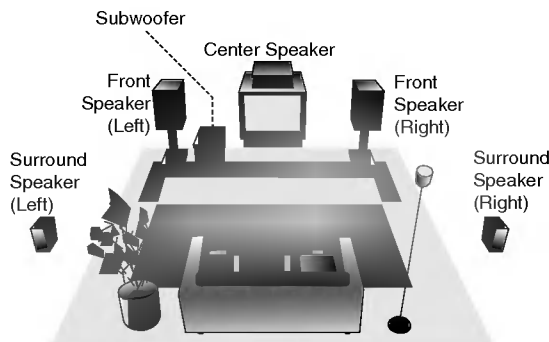

Speaker Positioning Example



- We recommend that you use the magnetic shielded speakers for the front left/right speakers and center speakers to protect from the video noise of the near-by television.
- Use the speakers that have a similarity in the sound character of all speakers.



In Dolby Digital or Dolby Pro Logic mode it is assumed that the interval from the listener to each speakers is same. But if the interval from the center or rear left and right speakers to the listener is closer than the interval from the listener to the front left and right speaker, the sound of center or rear left and right speaker will reach first than the sound of the front speakers to the listener.

In Dolby Digital and Dolby Pro Logic mode for improvement of this problem, by setting the delay time of the center or rear left and right speaker the sound from all speakers will arrive simultaneously to the listener.

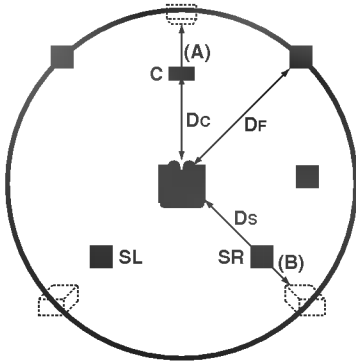

The interval from the speakers to the listener. If the distance from the listener to each speakers is same, in the Dolby Digital and Dolby Pro Logic mode the delay time of each speakers is as following.

In Dolby Digital mode

Center delay time : 0ms

Rear delay time: 5ms

In Dolby Pro Logic mode

Center delay time : cannot setting

Rear delay time : 15-30ms

If the rear delay time is set in Dolby Digital mode, in the Dolby Pro Logic mode the delay time will be automatically set.

The delay time is 1 msec per 30 cm.

If the center and rear speakers are further than the front speakers from the listener, the delay time will be at minimum.

If the distance of Ds is equal to or longer than the Df in the left figure, set the Surround Delay Time as 0ms. Otherwise, change the setting according to the below.

Ex) If the distance from front speakers to the listener is 3 m and from rear speakers from the listener is 1.5 m, in the Dolby Digital mode the rear delay time is 5 msec.

$$3\text{m (Df)} - 1.5\text{m (Ds)} = 1.5\text{m (B)}$$

$$1.5\text{m (B)} = 150\text{cm} / 30\text{cm} = 5\text{msec}$$

Center delay time setting (Dolby Digital mode only)

If the distance of Df is equal to the distance of Dc in the left figure, set the Center Delay Time as 0ms. Otherwise, change the setting according to the table below.

Ex) If the distance from the front speakers to the listener is 3m and from the center speaker to the listener is 2.4m, the center delay time is 2msec.

$$3\text{m (Df)} - 2.4\text{m (Dc)} = 60\text{cm (A)}$$

$$60\text{cm (A)} / 30\text{cm} = 2\text{msec}$$

Setting the delay time in the Dolby Digital and Dolby Pro Logic mode

Press DELAY.

The current surround delay time is appeared in the display window.

You can select center delay time by pressing ◀▶ in the Dolby Digital mode only.

Press ▲/▼ to change the delay time.

If setting is complete, press DELAY.

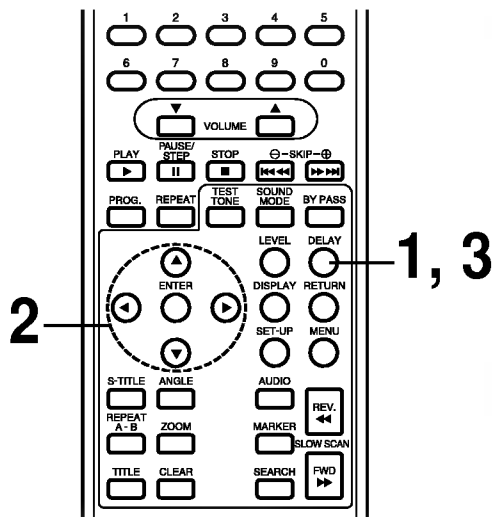

- You can adjust the center delay time only in the Dolby Digital mode and its delay time appears.

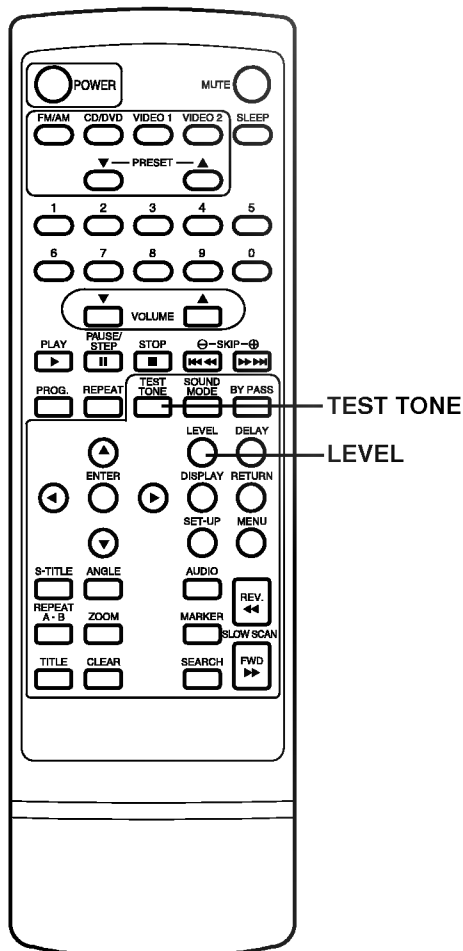

Setting the sound level of the desired channel

- Press LEVEL.**
 The LEVEL indicator will appear in the display window.
- Press ◀/▶ to select a desired speaker to set.**
 Each time you press the ◀/▶ button, it is changed as the following order;
 FL (Front Left) → C (Center) → FR (Front Right) → SR (Surround Right) → SL (Surround Left) → SW (Subwoofer) → FL (Front Left)
 - On the 2 channel stereo mode, you can only select the SW (Subwoofer).
- Press ▲/▼ to adjust the sound level of the selected channel.**
- Repeat step 2-3 and adjust the sound level of the other channels.**
- If setting is complete, press LEVEL.**

Setting the Balance between each channels by using the test tone

In Dolby Digital and Dolby Pro Logic mode by using the test tone function you can easily adjust the sound balance of the speakers from the listener's position.

- Select the test tone mode by pressing TEST TONE.**
 - A hiss noise comes out for 2 seconds from each speakers in the following order;
 FL (Front Left) → C (Center) → FR (Front Right) → SR (Surround Right) → SL (Surround Left) → SW (Subwoofer) → FL (Front Left)
- Adjust the sound level the same way as described in “Setting the sound level of the desired channel” above, so that all the speaker’s sound level is same from the listener’s position.**
 - During operating the test tone, if you adjust the sound level, it will be paused in the current speaker channel.

For your reference

- **to adjust the volume of all the speakers at one time.**
Use the VOLUME control.



Once the initial settings have been completed, the DVD receiver can always be operated under the same conditions (especially with DVD discs). The settings will be retained in the memory until they are changed, even if the power is switched off.

Selection of initial settings

Press SET-UP in the stop or playback mode.
The SET-UP menu is displayed.

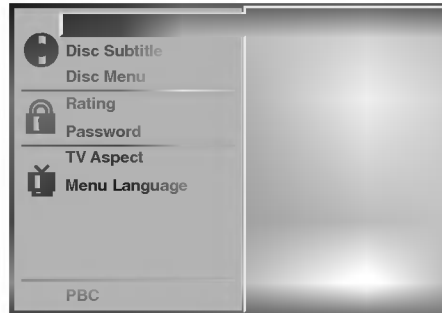

Press ▲/▼ to select the desired item.
The screen will show the current setting for the selected item, and the alternate setting(s).

- Disc Audio (see page 36.)
- Disc Subtitle (see page 36.)
- Disc Menu (see page 36.)
- Rating (see page 37.)
- Password (see page 38.)
- TV Aspect (see page 39.)
- Menu Language (see page 40.)
- PBC (see page 40.)

Press ► and then ▲/▼ to select the desired setting and press ENTER.

- Some items require additional steps. (See the respective page.)

When the alternate setting is selected the screen returns to the Initial Settings display.

To exit SET-UP menu

Press SET-UP, RETURN or PLAY.

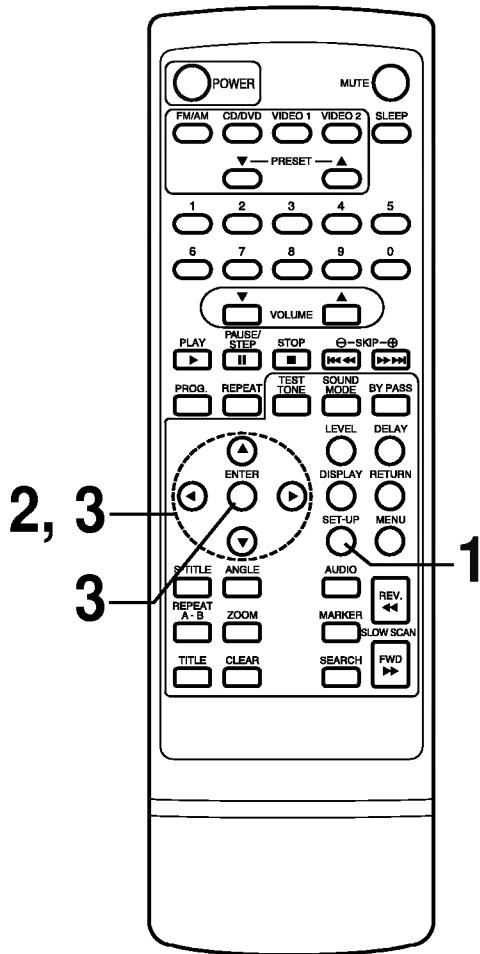



This is to select the audio soundtrack language, subtitle language and the language used in title menus or DVD menus which will always be used for every disc to be played back.

When you play back a DVD video disc, the DVD receiver automatically displays the pre-selected subtitle language if it is included on the disc.

At the setup screen, press ▲/▼ to select “Disc Audio” and press ►.



Press ▲/▼ to select the desired language and then press ENTER.

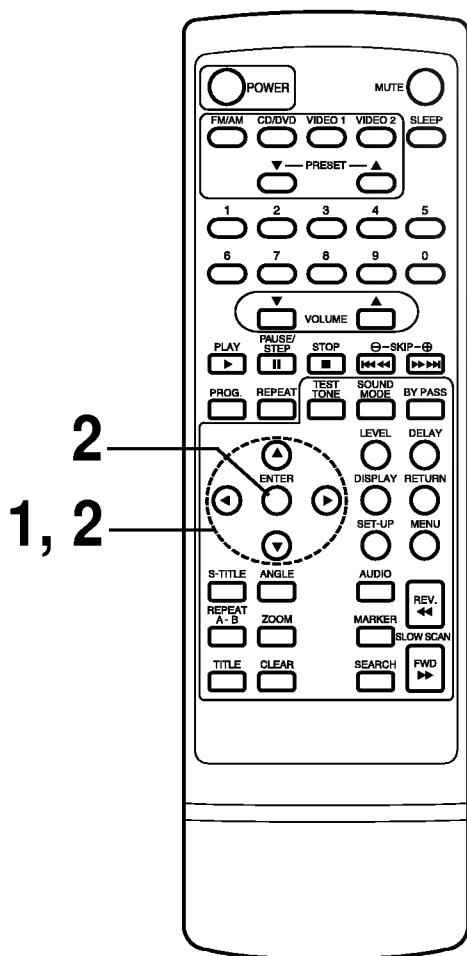

- Original** : The original language of each disc will be selected.
- English** : The English will be Selected.
- Other** : Another language can be selected. You can input 4-digit language code. (Refer to the language codes on page 41. Press CLEAR if an incorrect language code is entered.)

The “Disc Subtitle” and “Disc Menu” are selected by the same method.

- If the language selected is not available on the disc, the original language designated by each disc will be selected.



This is to prohibit the playing of specified DVDs which are unsuitable for children.

- Some DVD discs contain a restriction level which enables parents to remove scenes or prevent playback of discs by children. DVD receivers are equipped with a password designed to prevent children from changing the level.

Selecting rating level (DVD only)

At the SET-UP screen, press ▲/▼ to select “Rating” and press ►.



Press ▲/▼ to select the desired level and press ENTER.

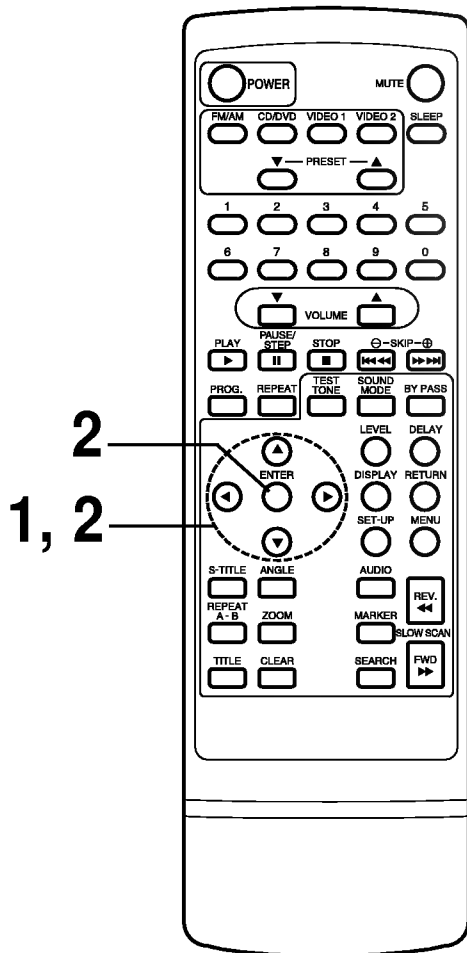

You cannot play DVD video discs rated higher than the level you selected unless you cancel the parental lock function. For example, when you select level 7, discs rated higher than level 7 are blocked and cannot be played.

If you change the level and enter a password, playback of all DVDs with ratings higher than your selection will be blocked, unless the correct password is entered again. For example: if you change the level to “5”, the DVD receiver will not play discs with ratings of “6”, “7” or “8” unless the correct password is entered on the remote control.

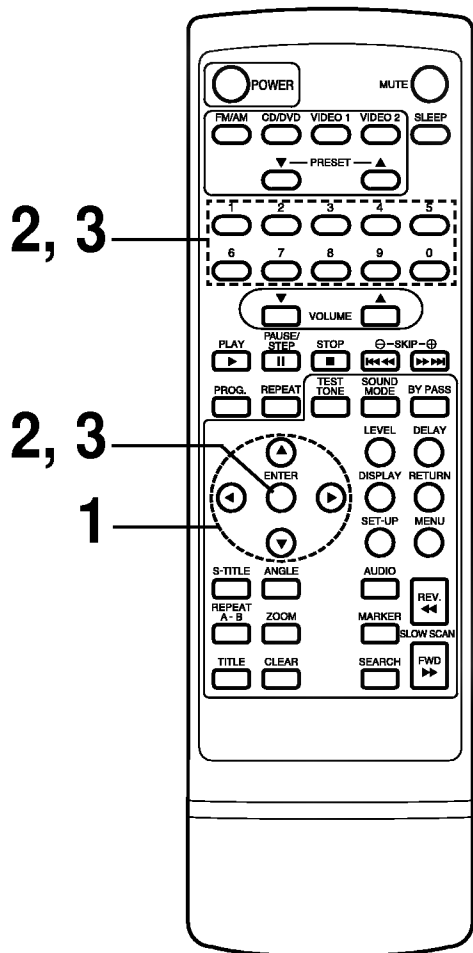

Setting your password (DVD only)

If you change the rating level to “7” or lower, you must enter a 4-digit “password” to prevent playback of discs with higher ratings.

At the SET-UP screen, press ▼ to select “Password” and press ►.



Input a 4-digit password and press ENTER.

Example : 1234
Do not forget your password.

Input the 4-digit password again and press ENTER to verify.

Setting is finished.

The rating is locked. Any disc whose rating is higher than the setting, cannot be played back unless the correct password is entered.

To change/clear memorized password

At the SET-UP screen, press ▼ to select “Password” and press ►.

Input your password and press ENTER.



To change or clear your password, press ▲/▼ to select the “Change” or “Clear” and press ENTER.

To change the rating level/password, follow the steps on page 37-38 again.

To clear your 4-digit password

If you forget your password, to clear the current password, follow the procedure below.

At the SET-UP screen

- 1 Press ▼ to select “Password” item.
- 2 Enter 6-digit number “210499” and then press ENTER.
The 4-digit password is cleared.
- 3 Enter a new password
Refer to “Setting your password” section on the right.



Select the appropriate screen type according to your TV set; conventional size screen (4:3) or wide-screen (16:9).

At the SET-UP screen, press ▲/▼ to select "TV Aspect" and press ►.

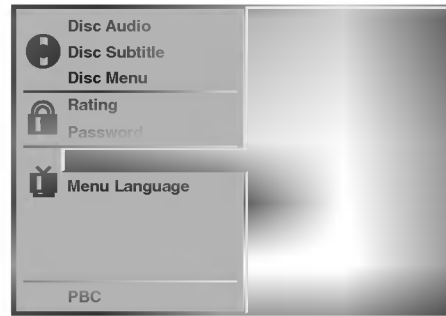
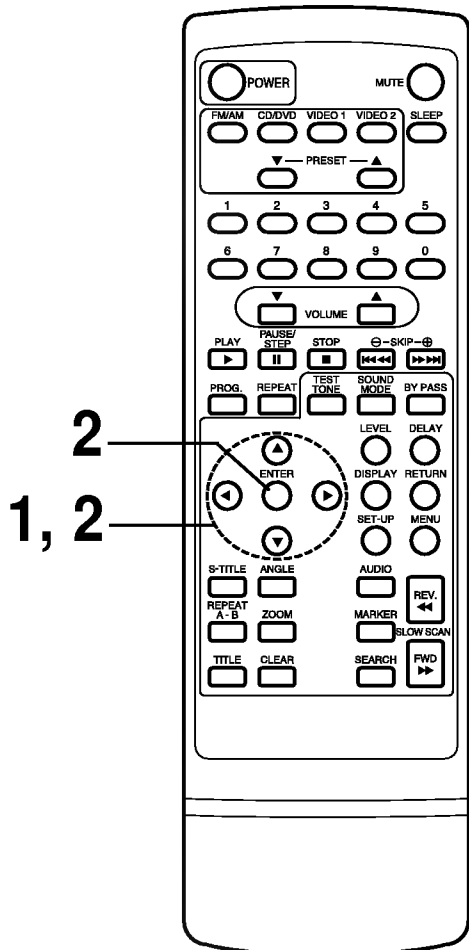

Press ▲/▼ to select the desired Aspect and press ENTER.

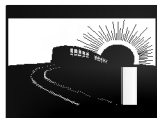

4:3 Letterbox

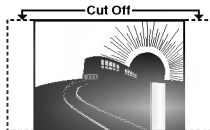

4:3 Panscan

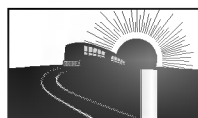

16:9 Wide

4:3 Letterbox : The video material not formatted in the Pan & Scan style is played back in the letterbox style (black bands appear at top and bottom of screen).

4:3 Panscan : Select when a conventional TV set is connected. The video material formatted in the Pan & Scan style is played back in that style (the left and right edges are cut off).

16:9 Wide : Select when a wide-screen TV set is connected. Played in "FULL" size. (Setting the wide-screen TV to "FULL" mode is also necessary.)

* Each screen shows an example when the video material for a wide-screen is played. (This setting does not affect the video material for conventional size.)



Selects language for SET-UP menus and displays on the TV.

At the SET-UP screen, press ▲/▼ to select “Menu Language” and press ►.

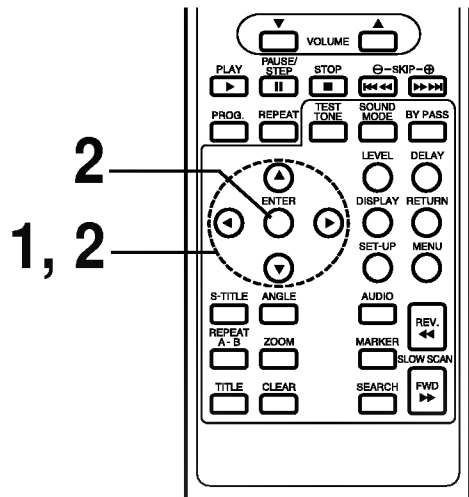

Press ▲/▼ to select the desired Language and press ENTER.



The PBC (Playback Control) settings can be changed.

At the SET-UP screen, press ▲/▼ to select “PBC” and press ►.

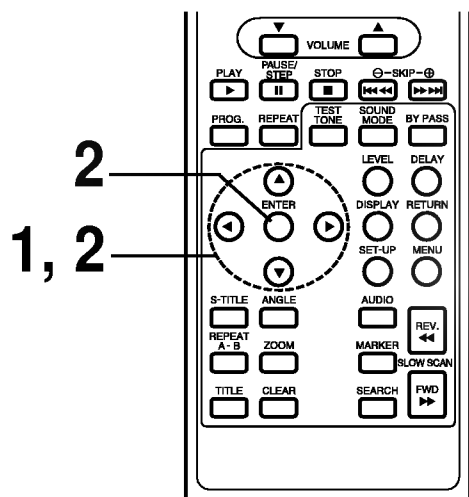

Press ▲/▼ to select the desired item and press ENTER.

■ **PBC On/Off**

Set Playback Control (PBC) to On or Off

On: Video CDs with PBC are played back according to the PBC.



Off: Video CDs with PBC are played back in the same way Audio CDs.



Enter the appropriate code number for the initial settings "Audio", "Subtitle" and/or "Menu" (See page 36).

Code	Language	Code	Language	Code	Language	Code	Language
6565	Afar	7079	Faroese	7678	Lingala	8375	Slovak
6566	Abkhazian	7082	French	7679	Laothian	8376	Slovenian
6570	Afrikaans	7089	Frisian	7684	Lithuanian	8377	Samoan
6577	Ameharic	7165	Irish	7686	Latvian, Lettish	8378	Shona
6582	Arabic	7168	Scots Gaelic	7771	Malagasy	8379	Somali
6583	Assamese	7176	Galician	7773	Maori	8381	Albanian
6588	Aymara	7178	Guarani	7775	Macedonian	8382	Serbian
6590	Azerbaijani	7185	Gujarati	7776	Malayalam	8385	Sudanese
6665	Bashkir	7265	Hausa	7778	Mongolian	8386	Swedish
6669	Byelorussian	7273	Hindi	7779	Moldavian	8387	Swahili
6671	Bulgarian	7282	Croatian	7782	Marathi	8465	Tamil
6672	Bihari	7285	Hungarian	7783	Malay	8469	Telugu
6678	Bengali; Bangla	7289	Armenian	7784	Maltese	8471	Tajik
6679	Tibetan	7365	Interlingua	7789	Burmese	8472	Thai
6682	Breton	7378	Indonesian	7865	Nauru	8473	Tigrinya
6765	Catalan	7383	Icelandic	7869	Nepali	8475	Turkmen
6779	Corsican	7384	Italian	7876	Dutch	8476	Tagalog
6783	Czech	7387	Hebrew	7879	Norwegian	8479	Tonga
6789	Welsh	7465	Japanese	7982	Oriya	8482	Turkish
6865	Danish	7473	Yiddish	8065	Panjabi	8484	Tatar
6869	German	7487	Javanese	8076	Polish	8487	Twi
6890	Bhutani	7565	Georgian	8083	Pashto, Pushto	8575	Ukrainian
6976	Greek	7575	Kazakh	8084	Portuguese	8582	Urdu
6978	English	7576	Greenlandic	8185	Quechua	8590	Uzbek
6979	Esperanto	7577	Cambodian	8277	Rhaeto-Romance	8673	Vietnamese
6983	Spanish	7578	Kannada	8279	Rumanian	8679	Volapük
6984	Estonian	7579	Korean	8285	Russian	8779	Wolof
6985	Basque	7583	Kashmiri	8365	Sanskrit	8872	Xhosa
7065	Persian	7585	Kurdish	8368	Sindhi	8979	Yoruba
7073	Finnish	7589	Kirghiz	8372	Serbo-Croatian	9072	Chinese
7074	Fiji	7665	Latin	8373	Singhalese	9085	Zulu

This DVD receiver can play back the following discs.

	Disc mark	Contents	Disc size	Maximum playback time
DVD video discs		Audio+Video (moving pictures)	12 cm	Approx. 4 hours (single sided disc)
				Approx. 8 hours (double sided disc)
			8 cm	Approx. 80 minutes (single sided disc)
				Approx. 160 minutes (double sided disc)
Video CDs		Audio+Video	12 cm	74 minutes
			8 cm	20 minutes
Audio CDs		Audio	12 cm	74 minutes
			8 cm	20 minutes

In addition, this unit can play back a CD-R or CD-RW that contains audio titles or MP3 files.

You cannot playback discs other than those listed above. (CD-ROM, CD-Extra, CD-G, photo CD, and CD-i discs can not be played on this DVD receiver.)

Region Management Information: This DVD receiver is designed and manufactured to respond to the Region Management Information that is recorded on a DVD disc. If the Region number described on the DVD disc does not correspond to the Region number of this DVD receiver, this DVD receiver cannot play that disc.

The Region number of this DVD receiver is 4.



You may not be able to play back some DVD video discs on this DVD receiver if they were purchased from outside your geographic area or made for business purposes.

When you try to play back an unauthorized disc, "**Check Regional Code**" appears on the TV screen.

It is forbidden by law to copy, broadcast, show, broadcast on cable, play in public, and rent copyrighted material without permission.

DVD video discs are copy protected, and any recordings made from these discs will be distorted.

This product incorporates copyright protection technology that is protected by method claims of certain U.S. patents and other intellectual property rights owned by Macrovision Corporation and other rights owners. Use of this copyright protection technology must be authorized by Macrovision Corporation, and is intended for home and other limited viewing uses only, unless otherwise authorized by Macrovision Corporation. Reverse engineering or disassembly is prohibited.

Symptoms and Correction

Check the following guide for the possible cause of a problem before contacting service.

Symptom	Cause	Correction
No power.	<ul style="list-style-type: none"> The power cord is disconnected. 	<ul style="list-style-type: none"> Plug the power cord into the wall outlet securely.
The power is on, but the DVD receiver does not work.	<ul style="list-style-type: none"> No disc is inserted. 	<ul style="list-style-type: none"> Insert a disc. (Check that the DVD or, audio CD indicator in the DVD display is lit.)
No picture.	<ul style="list-style-type: none"> The TV is not set to receive DVD signal output. 	<ul style="list-style-type: none"> Select the appropriate video input mode on the TV so the picture from the DVD receiver appears on the TV screen.
	<ul style="list-style-type: none"> The video cable is not connected securely. 	<ul style="list-style-type: none"> Connect the video cable into the jacks securely.
	<ul style="list-style-type: none"> The connected TV power is turned off. 	<ul style="list-style-type: none"> Turn on the TV.
There is no sound or only a very low-level sound is heard.	<ul style="list-style-type: none"> The equipment connected with the audio cable is not set to receive DVD signal output. 	<ul style="list-style-type: none"> Select the correct input mode of the audio receiver so you can listen to the sound from the DVD receiver.
	<ul style="list-style-type: none"> The audio cables are not connected securely. 	<ul style="list-style-type: none"> Connect the audio cable into the jacks securely.
	<ul style="list-style-type: none"> The power of the equipment connected with the audio cable is turned off. 	<ul style="list-style-type: none"> Turn on the equipment connected with the audio cable.
	<ul style="list-style-type: none"> The audio connecting cord is damaged. 	<ul style="list-style-type: none"> Replace it with new one.
The playback picture is poor.	<ul style="list-style-type: none"> The disc is dirty. 	<ul style="list-style-type: none"> Clean the disc.
The DVD receiver does not start playback.	<ul style="list-style-type: none"> No disc is inserted. 	<ul style="list-style-type: none"> Insert a disc. (Check that the DVD, or audio CD indicator in the DVD display is lit.)
	<ul style="list-style-type: none"> An unplayable disc is inserted. 	<ul style="list-style-type: none"> Insert a playable disc. (Check the disc type, color system and Regional code.)
	<ul style="list-style-type: none"> The disc is placed upside down. 	<ul style="list-style-type: none"> Place the disc with the playback side down.
	<ul style="list-style-type: none"> The disc is not placed within the guide. 	<ul style="list-style-type: none"> Place the disc on the disc tray correctly inside the guide.
	<ul style="list-style-type: none"> The disc is dirty. 	<ul style="list-style-type: none"> Clean the disc.
	<ul style="list-style-type: none"> A menu is on the TV screen. 	<ul style="list-style-type: none"> Press the SET-UP button to turn off the menu screen.
	<ul style="list-style-type: none"> The Rating level is set. 	<ul style="list-style-type: none"> Cancel the Rating function or change the rating level.
Severe hum or noise is heard.	<ul style="list-style-type: none"> The plugs and jacks are dirty. 	<ul style="list-style-type: none"> Wipe them with a cloth slightly moistened with alcohol.
	<ul style="list-style-type: none"> The disc is dirty. 	<ul style="list-style-type: none"> Clean the disc.
	<ul style="list-style-type: none"> The speakers and components are connected poorly. 	<ul style="list-style-type: none"> Connect the speakers and components securely.
	<ul style="list-style-type: none"> The DVD receiver is located with TV nearby. 	<ul style="list-style-type: none"> Move your TV away from the audio components.

Symptoms and Correction

Symptom	Cause	Correction
Recording cannot be done.	• The components are connected incorrectly.	• Connect the components correctly.
	• The source is selected in correctly.	• Select the source with FUNCTION button (CD/DVD, VIDEO 1, VIDEO 2 or Tuner).
Radio stations cannot be tuned in.	• The antennas are connected poorly.	• Connect the antenna securely.
		• Adjust the antennas and connect an external antenna if necessary.
	• The signal strength of the stations is too weak (when tuning in with automatic tuning).	• Tune in the station manually.
	• No stations have been preset or preset stations have been cleared (when tuning by scanning preset stations).	• Preset the stations(page 29).
The remote control does not work properly.	• The remote control is not pointed at the remote sensor of the DVD receiver.	• Point the remote control at the remote sensor of the DVD receiver.
	• The remote control is too far from the DVD receiver.	• Operate the remote control within about 23 ft (7 m).
	• There is an obstacle in the path of the remote control and the DVD receiver.	• Remove the obstacle.
	• The batteries in the remote control are exhausted.	• Replace the batteries with new ones.

Using the RESET button (located on the bottom of DVD receiver)

This button is used to solve the problem as following symptom;

- When the power can not on, even if power cord is connected to the outlet.
- When the window display does not display.
- When the DVD receiver does not operate normally.

- Use a pencil or ball-pen when you press the **RESET** button.

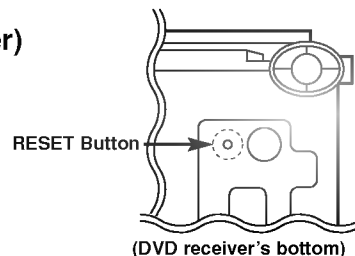

NOTES:

- If the **RESET** button is pressed, then all memorized data will be cleared such as preset stations etc..
- Reset the settings according to instructions.

You can reset the DVD receiver also as below.



Unplug the power cord and then plug the power cord again after more than five seconds.



[General]	Power supply	AC 240V, 50 Hz		
	Power consumption	70 W		
	Mass	10.2 lbs (4.6 kg)		
	External dimensions (W x H x D)	360 x 82 x 388 mm (14.2 X 3.2 X 15.3 inches)		
	Operating conditions	Temperature: 5°C to 35°C, Operation status: Horizontal		
	Operating humidity	5% to 90%		
[CD/DVD]	Laser	Semiconductor laser, wavelength 650 nm		
	Signal system	PAL 625/50, NTSC 525/60		
	Frequency response (audio)	4 Hz to 20 kHz		
	Signal-to-noise ratio (audio)	More than 90 dB (1 kHz, NOP, 20 kHz LPF/A-Filter)		
	Dynamic range (audio)	More than 95 dB		
	Harmonic distortion (audio)	0.15 % (1 kHz, at 12W position)		
[Video]	Video input	1.0 V (p-p), 75 Ω, negative sync., RCA jack		
	Video output	1.0 V (p-p), 75 Ω, negative sync., RCA jack		
	S-video output	(Y) 1.0 V (p-p), 75 Ω, negative sync., Mini DIN 4-pin x 1 (C) 0.3 V (p-p), 75 Ω		
[Tuner]	FM	Tuning Range	87.5 - 108 MHz	
		Intermediate Frequency	10.7 MHz	
		Signal-to Noise Ratio	50 dB	
	AM (MW)	Frequency Response	150 - 12,000 Hz	
		Tuning Range	522 - 1,611 kHz	
		Intermediate Frequency	450 kHz	
[Amplifier]	Stereo mode	30W + 30W (8 Ω at 1 kHz, THD 1 %)		
	Surround mode (* Depending on the sound mode settings and the source, there may be no sound output.)	Front: 30W + 30W Center*: 30W Surround*: 30W + 30W (8Ω at 1 kHz, THD 1 %) Subwoofer*: 30W (8Ω at 60 Hz, THD 1 %)		
	Inputs	VIDEO 1, 2		
	Outputs	VIDEO 1 (AUDIO OUT) : 2 V WOOFER: 2 V		
[Speakers]		Satellite Speaker (FE-3500TE)	Passive Subwoofer (FE-3500WE)	
	Type	1 Way 1 Speaker	1 Way 1 Speaker	
	Impedance	8 Ω	8 Ω	
	Frequency Response	120 - 20,000 Hz	35 - 1,000 Hz	
	Sound Pressure Level	84 dB/W (1m)	83 dB/W (1m)	
	Rated Input Power	30 W	30 W	
	Max. Input Power	60 W	60 W	
	Net Dimensions (W x H x D)	90 x 125 x 106 mm	160 x 350 x 325 mm	
Net Weight	0.7 kg	4.78 kg		
[Supplied Accessories]	• Audio cable	1	• Video cable	1
	• Speakers	6	• Speaker cables	5
	• Remote control	1	• Batteries (AAA)	2
	• AM loop antenna	1	• FM antenna	1

* Designs and specifications are subject to change without notice.



The **LG Express Guarantee**

This specifically covers replacement and repair of any defective componentry or faults in manufacture for the period specified in the  **LG** Guarantee Decal above. However,  **LG** accepts no liability where any goods fail to comply with this express guarantee because of any reasons beyond  **LG** control.

Faulty components will be replaced by  **LG** at no cost to the owner. Similarly all workshop labour costs needed to restore the goods to their original working condition will be met by  **LG** during the guarantee period.

This applies to work done in any approved  **LG** Service Centre and specifically excludes travel time, freight or any other related charges.

The conditions of this Express guarantee only apply if repairs are carried out by an approved  **LG** Service Centre in New Zealand.

This guarantee is not transferrable except as provided by the Consumer Guarantee Act 1993.

Express Guarantee Service

 **LG** guarantees the continued supply of spare parts for a period after the date of manufacture of not less than 5 years for electrical components and 3 years for cabinet and other cosmetic components.

If there is any conflict between this  **LG** Express Guarantee and the provisions of the Consumer Guarantee Act 1993, the provisions of the Act shall apply.

Model No: _____

Date Purchased: _____

Serial No: _____

Purchased from: _____