



CD/RADIO CASSETTE RECORDER

Owner's Manual

MODEL : CD-580A (AM/FM)

Read this manual carefully before operating your set.

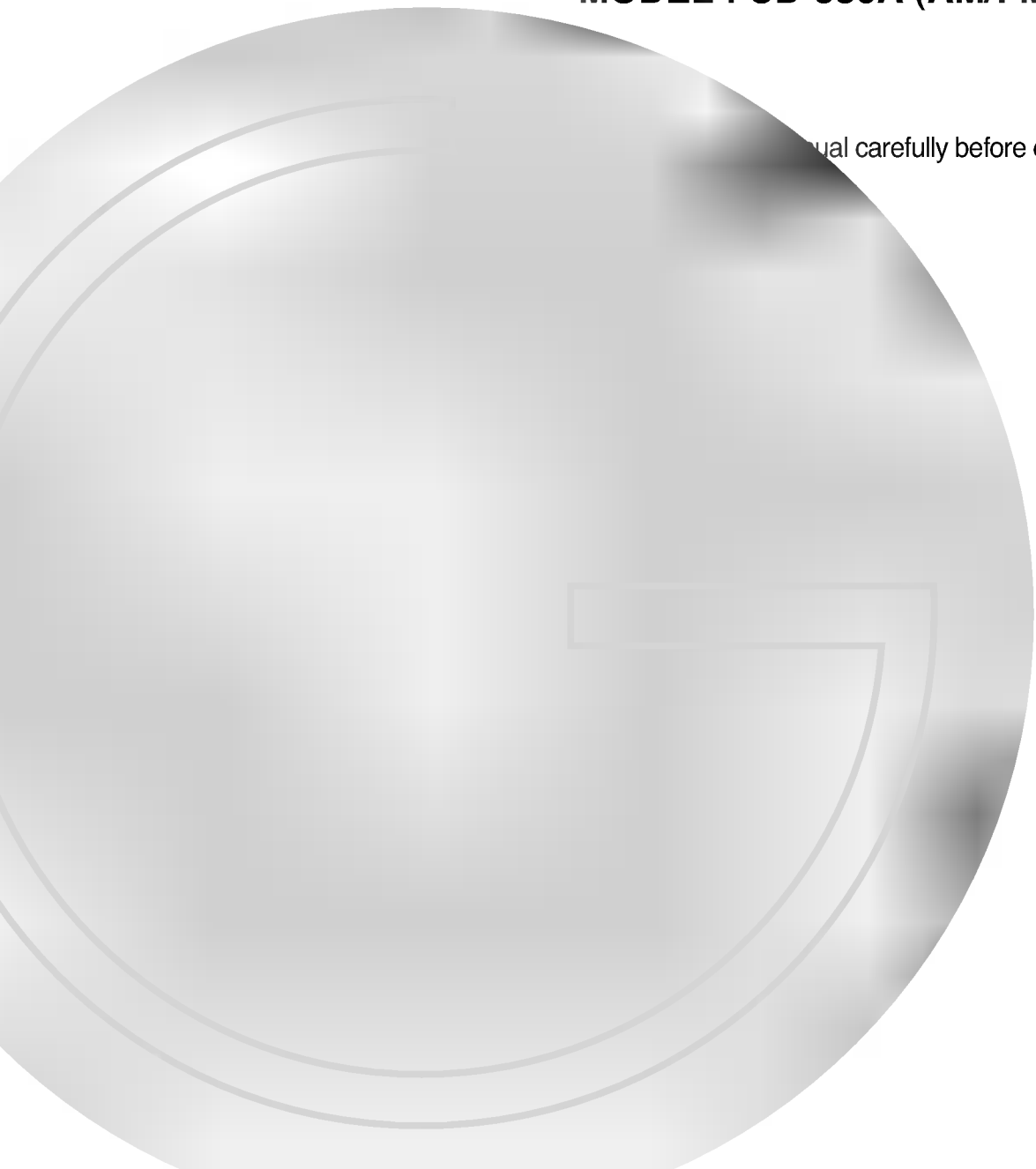

P/NO:3828SNA012L

Specifications

To avoid electrical shock; do not open the cabinet. Refer servicing to qualified personnel only.
Shock Hazard - do not open.

CAUTION

Use of controls or adjustments or performance of procedures other than those specified herein may result in hazardous radiation exposure.

This class B digital apparatus meets all requirements of the Canadian Interference - Causing Equipment Regulations.

For the customers in Europe

Laser component in this product is capable of emitting radiation exceeding the limit for Class 1.

CLASS 1 LASER PRODUCT
KLASSE 1 LASER PRODUKT
LUOKAN 1 LASER LAITE
KLASS 1 LASER APPARAT
CLASSE 1 PRODUIT LASER

This Compact Disc player is classified as a CLASS 1 LASER product.
The CLASS 1 LASER PRODUCT label is located on the exterior.

CAUTION:INVISIBLE LASER RADIATION WHEN OPEN AND INTERLOCKS DEFEATED. AVOID EXPOSURE TO BEAM.

WARNING:OSYNNLIG LASERSTRÅLNING NÄR DENNA DEL ÄR ÖPPNAD STRÅLEN ÄR FARLIG.

Attention:Quand l'appareil est ouvert, ne pas s'exposer aux radiations invisibles du faisceau laser.

This label is located on the interior.

The power switch of this unit is secondly mounted and does not disconnect the whole unit from the mains supply in the OFF position.

This product is conformed to EMC regulation 89/336/EEC and is therefore marked with the CE-label.

To reduce the risk of fire or electric shock, do not expose this appliance to rain or moisture.



RISK OF ELECTRIC SHOCK
DO NOT OPEN



CAUTION:
TO REDUCE THE RISK OF ELECTRIC SHOCK, DO NOT REMOVE COVER(OR BACK)
NO USER SERVICEABLE PARTS INSIDE.
REFER SERVICING TO QUALIFIED SERVICE PERSONNEL

The graphical symbols marked on the bottom or back of the set mean the following explanation.



The lightning flash with arrowhead within an equilateral triangle is intended to alert the user to the presence of uninsulated "dangerous voltage" within the product's enclosure that may be of sufficient magnitude to constitute a risk of electric shock to persons.



The exclamation point within an equilateral triangle is intended to alert the user to the presence of important operating and maintenance (servicing) instructions in the literature accompanying the appliance.

RADIO SECTION

Frequency range	
AM	: 520-1,630kHz
FM	: 87.5-108MHz
Intermediate frequencies	
AM	: 455kHz
FM	: 10.7MHz
Antenna (Aerial)	
FM	: Telescopic antenna (aerial)
AM	: Ferrite bar antenna (aerial)

CASSETTE SECTION

Recording system	: 4 Track 2 channel stereo
Frequency response	: 125-8,000Hz
S/N Ratio	: 40dB (Play)
	: 35dB (Rec/Play)

CD PLAYER SECTION

Frequency response	: 100-18,000Hz
S/N Ratio	: 60dB (1kHz)

GENERAL

Speakers (Woofer)	: 3.2Ω x 2
Output power (10% T.H.D):	: 2.5W x 2
Power supplies	
AC operation	: Refer to the indicated voltage on the bottom of unit
Battery operation	: DC 9V,6 "D" cells, (R 20) batteries not included
Power Consumption	: 17W
Dimensions (W x H x D)	: 535 x 177 x 250mm
Weight	: 4.0kg
P.M.P.O.	: 200W

※ **Note:** Design and specifications are subject to change without notice for improvement.

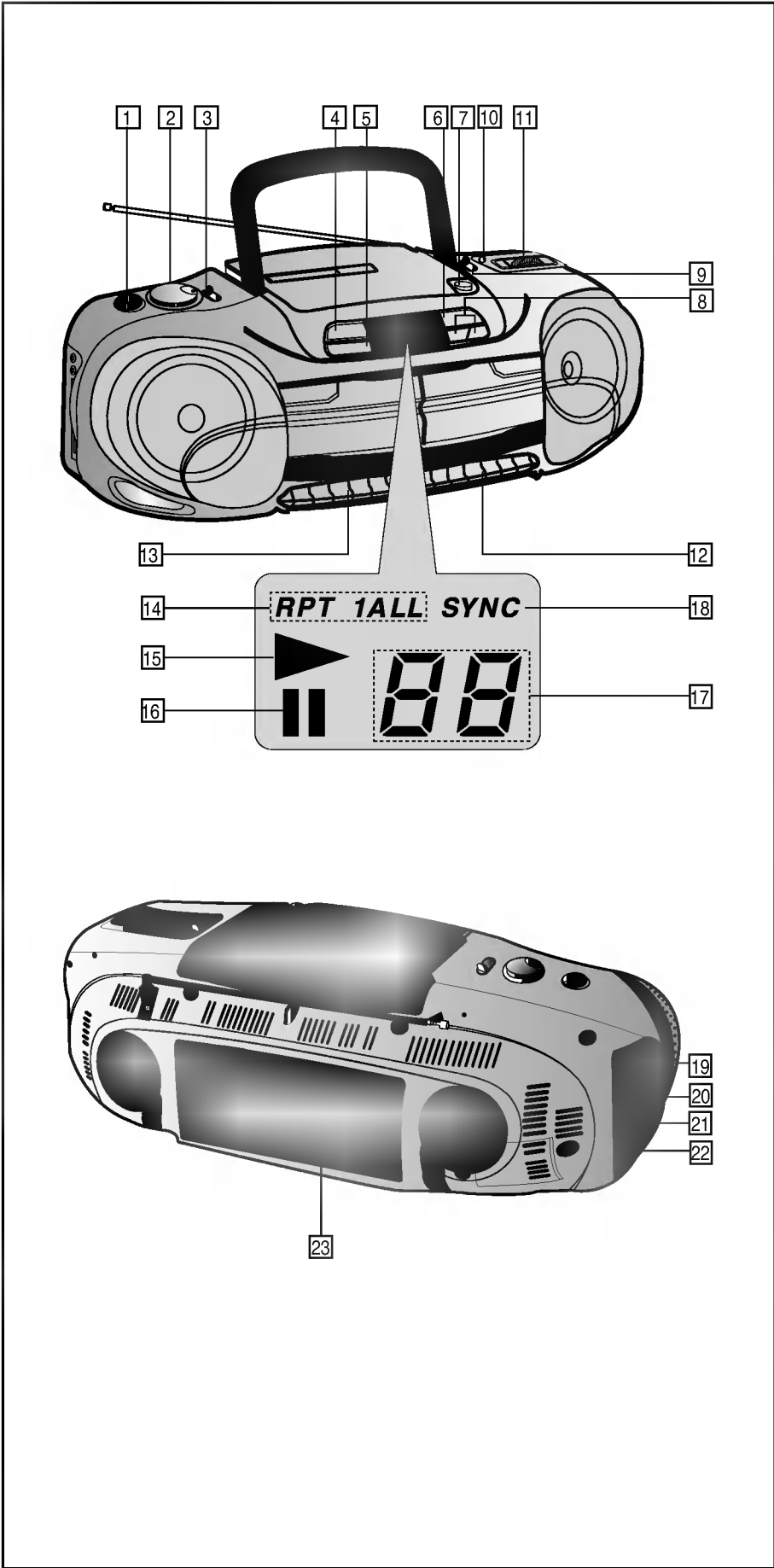

- 1 **TONE** Control
- 2 **VOLUME** Control
- 3 **FUNCTION** Switch
- 4 CD **STOP** button(■)
- 5 CD **REPEAT** button
- 6 CD **PLAY/PAUSE** button (▶/||)
- 7 CD **OPEN** button
- 8 CD **SKIP/SEARCH** buttons
(◀◀/▶▶)
- 9 **BAND** selector
- 10 **FM STEREO** indicator
- 11 **TUNING** dial
- 12 Deck B controls
- 13 Deck A controls
- 14 CD **RPT 1/ALL** indicator
- 15 CD **Play** indicator
- 16 CD **Pause** indicator
- 17 CD **TRACK** indicator
- 18 CD **SYNC** indicator
- 19 **PHONES** socket
- 20 **RIF** switch
- 21 AC Power input socket
- 22 Voltage Selector (optional)
- 23 Battery compartment

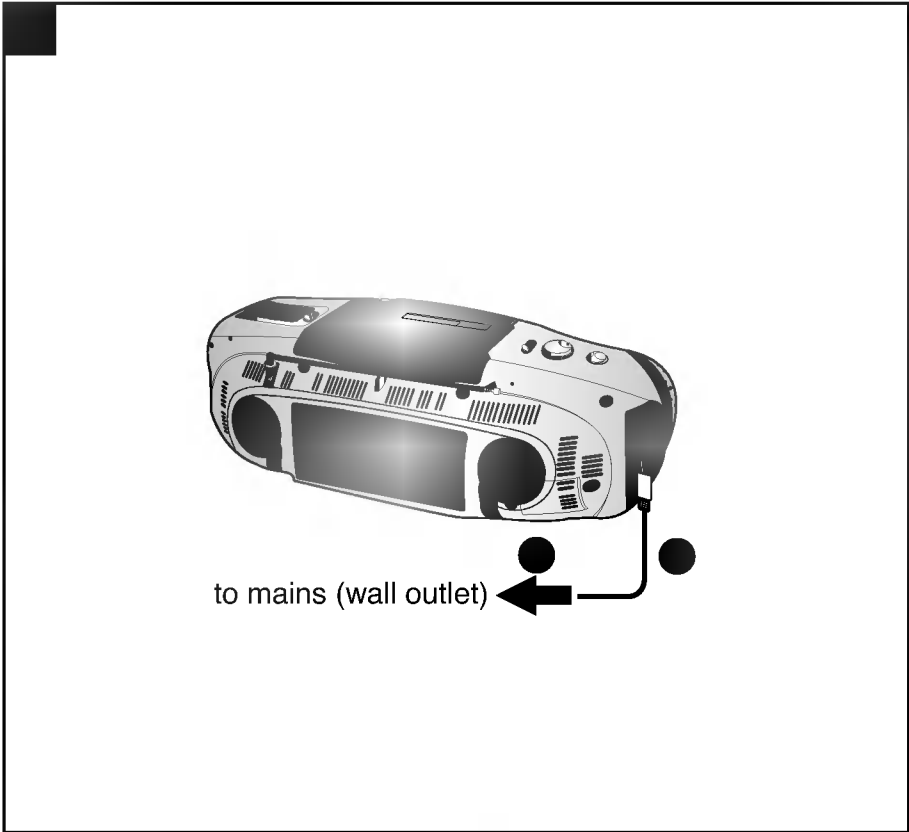

**Operating the player on AC
(see Fig. ■)**

Connect one end of the supplied AC cord (mains lead) to the AC IN socket located at the rear of the player. Plug the other end into the wall outlet.

Adjusting the voltage

If your player is equipped with a VOLTAGE SELECTOR at the rear, be sure to set it to your local power supply before connecting the power cord (mains lead).

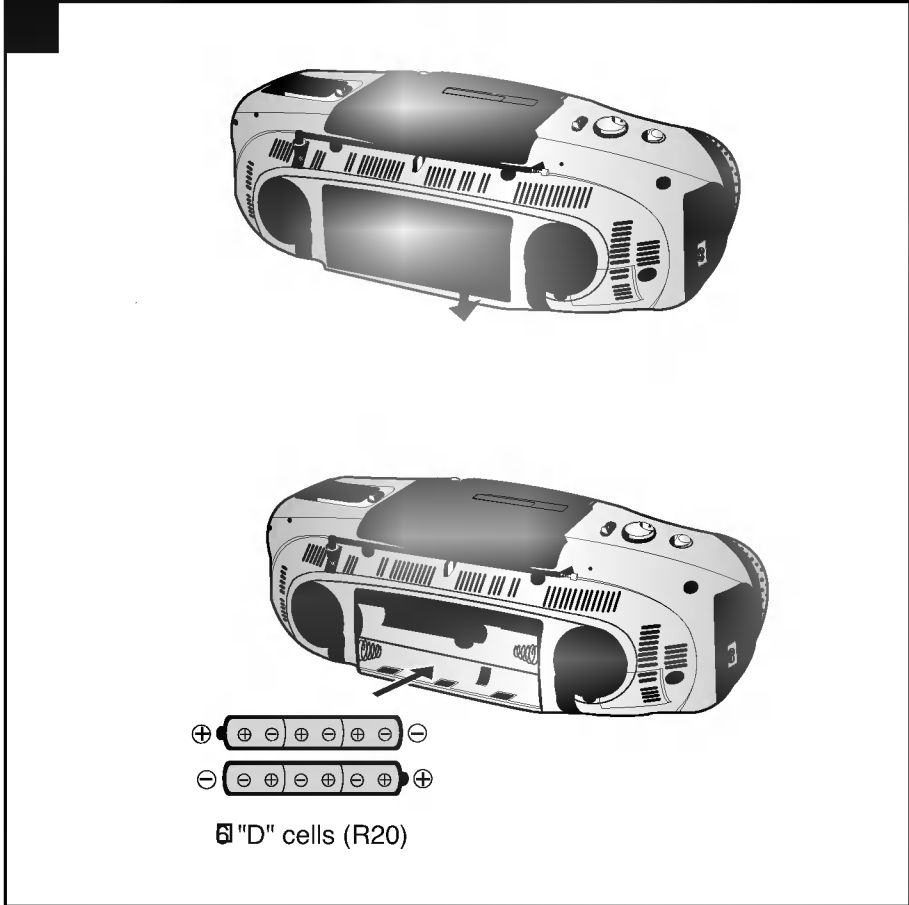

**Operating the player on batteries
(see Fig. ■)**

To run on battery power, disconnect the power cord from the unit. The batteries will not be used while the cord is connected.

When to replace the batteries

when the batteries are weak, replace all the batteries with new ones.

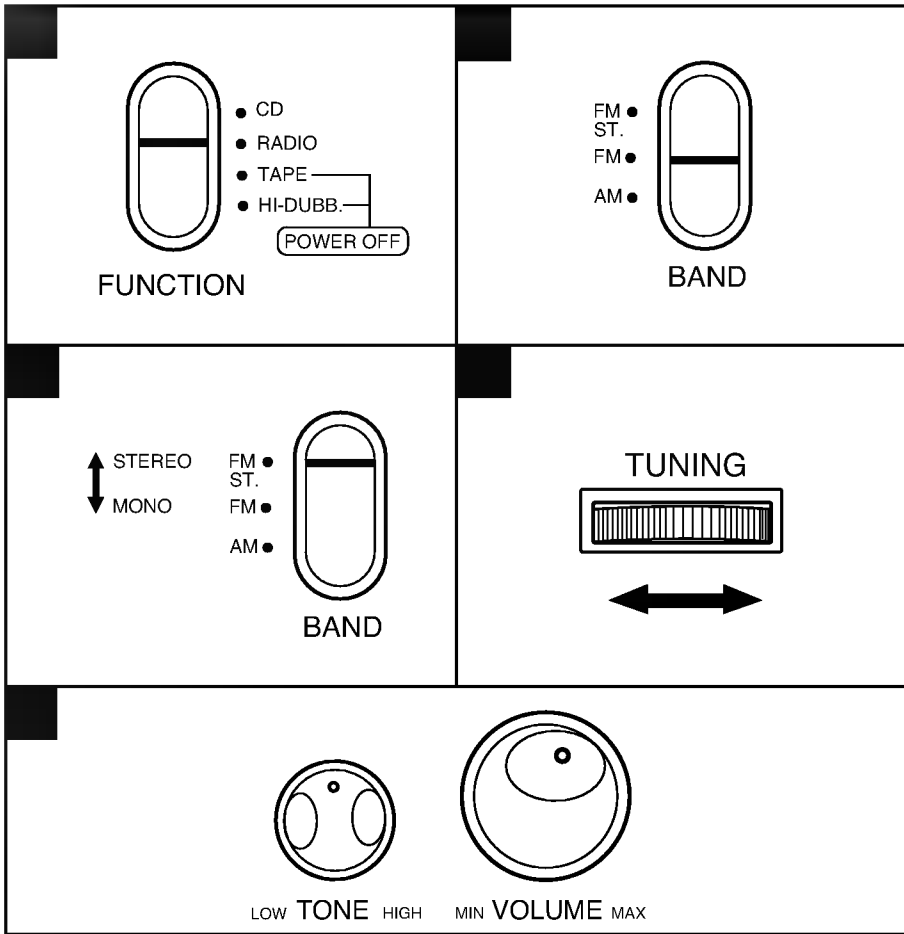

1. Set the **FUNCTION** Switch to **RADIO**.
2. Set the **BAND** selector to the desired band.
3. When listening to an FM broadcast, select the **MONO** or **STEREO**.
4. Tune in a station using the **TUNING DIAL**.

Note:
The FM stereo Indicator will light if the station is transmitting a stereo FM signal.

5. Adjust the **VOLUME** and **TONE** as necessary.

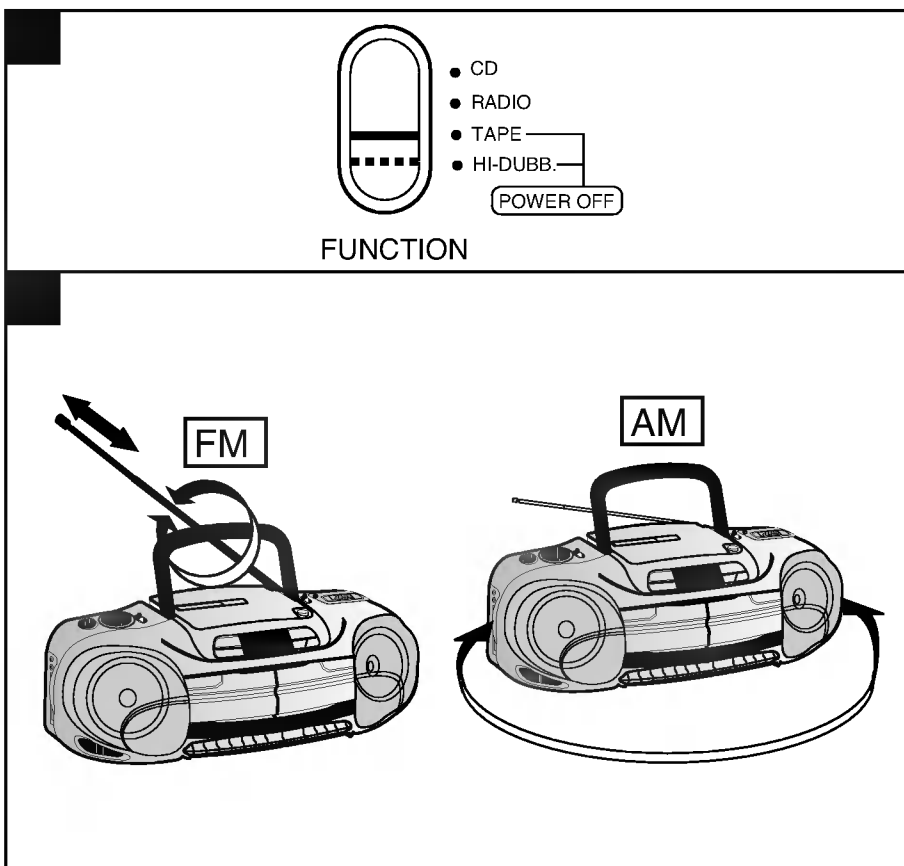

To turn off the radio
(see Fig. ■)

To improve broadcast reception
(see Fig. ■)
Reorient the aerial (for FM) or the player itself (for AM).

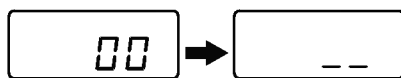
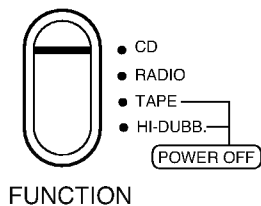

1. Set the **FUNCTION** switch to **CD**.
2. Press **OPEN** (▲).
Insert a CD.
3. Close the door.
4. Press **PLAY/PAUSE** (▶/||).
5. Adjust the **VOLUME** and **TONE** as necessary.
6. To stop play
Press **STOP** (■).
7. To turn off the CD, Set the **FUNCTION** switch to **POWER OFF**.

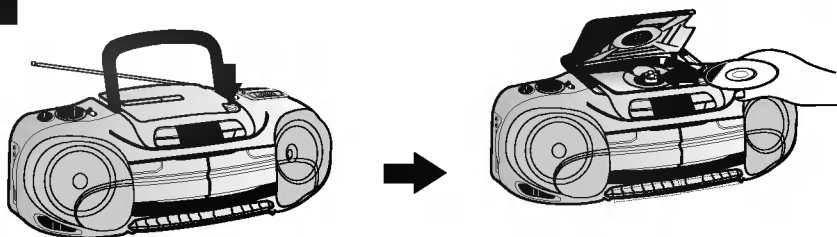

- **To pause:** Press the **PLAY/PAUSE** (▶/||). To resume play, press the **PLAY/PAUSE** (▶/||) again.
- **To eject a disc:** Press the **OPEN** (▲).

Do not press the **OPEN** (▲) during play

Otherwise the disc might be damaged.
Be sure the disc stops spinning first.

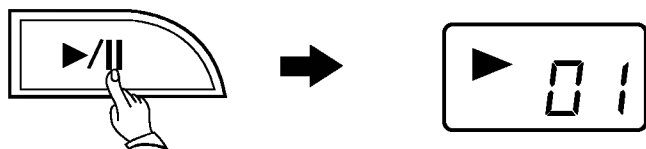
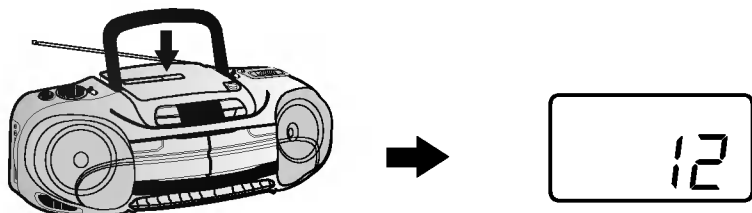

CD Skip

- **To SKIP to the beginning of the current song:**
Press ◀◀/◀◀ once.
- **To SKIP to the next song:**
Press ▶▶/▶▶ once.
- Press ◀◀/◀◀ or ▶▶/▶▶ repeatedly to **SKIP** over additional tracks.
- Press ◀◀/◀◀ twice to **SKIP** from the first track to the last.
- Press ▶▶/▶▶ once to **SKIP** from the last track to the first track.

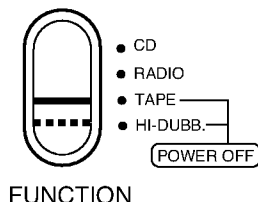
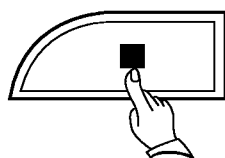
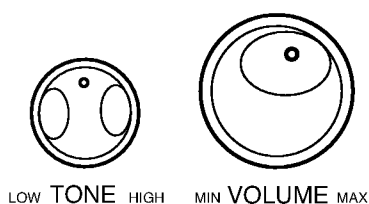

CD Search

To SEARCH a song at high speed:

Hold down ◀◀/◀◀ or ▶▶/▶▶

- Volume is reduced during **SEARCH**.
- Release the button to end **SEARCH**.

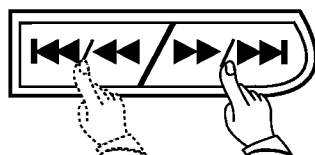

CD Repeat

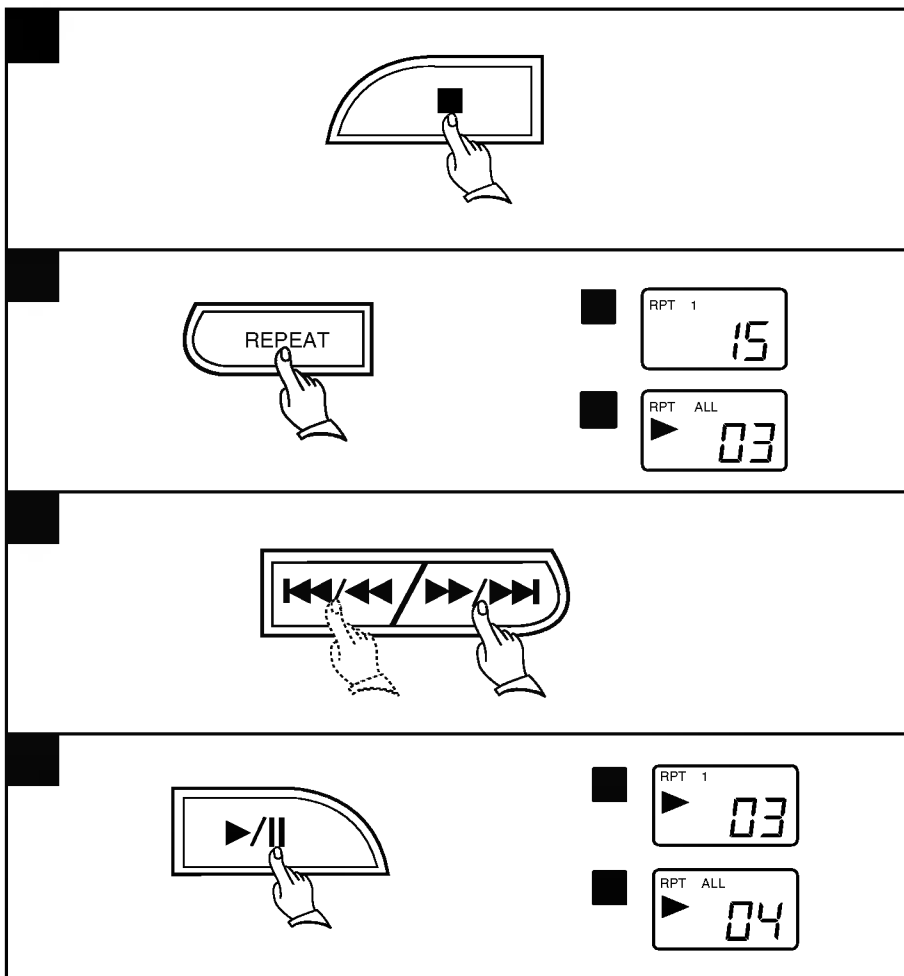

● REPEAT 1

1. Press **STOP** (■).
2. Press **REPEAT** once to repeat once song (See Fig. ■).
3. Press **◀/◀◀** or **▶▶/▶** to select the desired song.
4. Press **PLAY/PAUSE** (▶/||) (See Fig. ■).

● REPEAT ALL

1. Press **STOP** (■).
2. Press **REPEAT** a second time to repeat an entire CD or program (See Fig. ■).
3. Press **◀/◀◀** or **▶▶/▶** to select the desired song.
4. Press **PLAY/PAUSE** (▶/||) (See Fig. ■).

● To Cancel repeat

Press REPEAT a third time to enter normal PLAY mode.

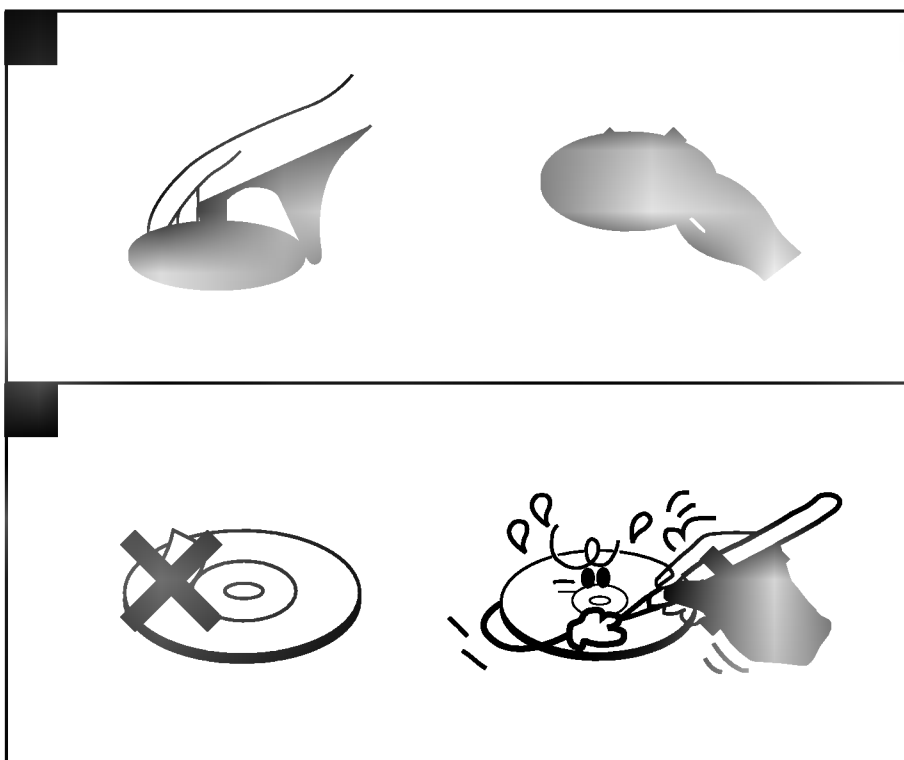

Notes on CD



- Handle the CD's by the edges, not by the flat surfaces.
- Don't stick tape to the surface.
Don't write anything on the disc.

Playing a Tape

1. Set the **FUNCTION** switch to **TAPE**.
2. Insert a cassette in deck A or deck B (Press **■ ▲ ST/EJ** button to open compartment)
3. Press **PLAY** (**▶** or **◀▶**) to start playing.
4. Adjust the **VOLUME** and **TONE** as necessary.

The listen to the other side of the cassette being played
Push down and release the **DIR**(**◀▶**) button(for deck B)

To select playback mode

Deck B	MODE selector
To play both sides of a cassette repeatedly	Set to ■  .
To play both sides of a cassette once	Set to ■  .

- Playback should be started from the forward (front) side. If not, the tape will stop playing when the playback of the reverse side is finished, even if the **MODE** selector is set to **■** .

Additional operations

To stop play, press **■ ▲ ST/EJ** .

To pause, press **||** (**PAUSE**).

To resume play after pause, press **||** (**PAUSE**).

To fast forward, press **◀◀** (**FF**)

To rewind, press **▶▶** (**REW.**)

To remove the cassette, press **■ ▲ ST/EJ** .

⊗ For private listening

Connect a pair of stereo headphone to **PHONES** socket by means of 3.5mm jack plug.

NOTE: Stereo headphones are not supplied with this unit.

Continuous playback

1. Set the **FUNCTION** switch to **TAPE**.
2. Insert a cassette into each deck
3. Be sure the **MODE** button of deck B is in the "**■** 
4. Press **PLAY** (**◀▶**) button for deck B. The cassette will begin to play.
5. Press **PLAY** (**▶**) and the **PAUSE** (**||**) button for deck A. After the cassette is finished playing in deck B, the pause feature for deck A is released automatically and the cassette in deck A is played.
6. Adjust the volume and tone.
7. To stop play, press the **■ ▲ ST/EJ** button.
Note : The unit switches off automatically after the second cassette is finished.
8. Press the **■ ▲ ST/EJ** button to remove the cassettes.

From a CD

1. Insert a tape into deck A.
2. Set the **FUNCTION** switch to **CD**.
3. Insert a CD.
4. Press **● (REC)**. **PLAY** (**▶**) goes down automatically. When recording from a CD, the disc will begin playing after 7 seconds.
5. **To stop recording**
Press **■ ▲ (ST/EJ)** on the cassette deck and **STOP** (**■**) on the CD player.

From a radio

1. Insert a tape into deck A.
2. Set the **FUNCTION** switch to **RADIO**
Select the desired band
3. Tune in a station
4. Press **● (REC)**. **PLAY** (**▶**) goes down automatically.
5. **To stop recording.**
Press **■ ▲ (ST/EJ)**

⊗ **To shut off the unit** set the **FUNCTION** switch to **POWER OFF**.

● Recording Level

The recording volume level is preset. Adjusting the volume and tone will have no effect on the recording.

● To reduce noise during AM recording

Set the **RIF** switch to 1, 2 or 3, depending on which one best reduces the noise.

NOTE:

Only use normal (ferric, IEC Type I) cassettes for recording, prerecorded music cassettes using chrome dioxide tape (recorded bias 120 μ s EQ) can played back, do not use chrome dioxide (CrO₂, IEC Type II) tapes for recording. Do not use Metal (IEC Type IV) tape cassettes for recording or playback.

Copying from deck B to deck A (DUBBING)

1. Insert the cassette to be dubbed in deck B.
2. Insert an empty cassette into deck A.
3. Set the **FUNCTION** switch to **HI-DUBB**.
If you want the cassettes to be dubbed at twice the normal speed.
For dubbing at regular speed, set the **FUNCTION** switch to **TAPE**.
4. Press the **PAUSE** (**||**) and the **REC**(**●**) for deck A.
5. Press the **PLAY** (**▶**) for deck B
The cassette will begin to record.
6. To stop the dubbing, press the **■ ▲ ST/EJ** button for decks A and B.