

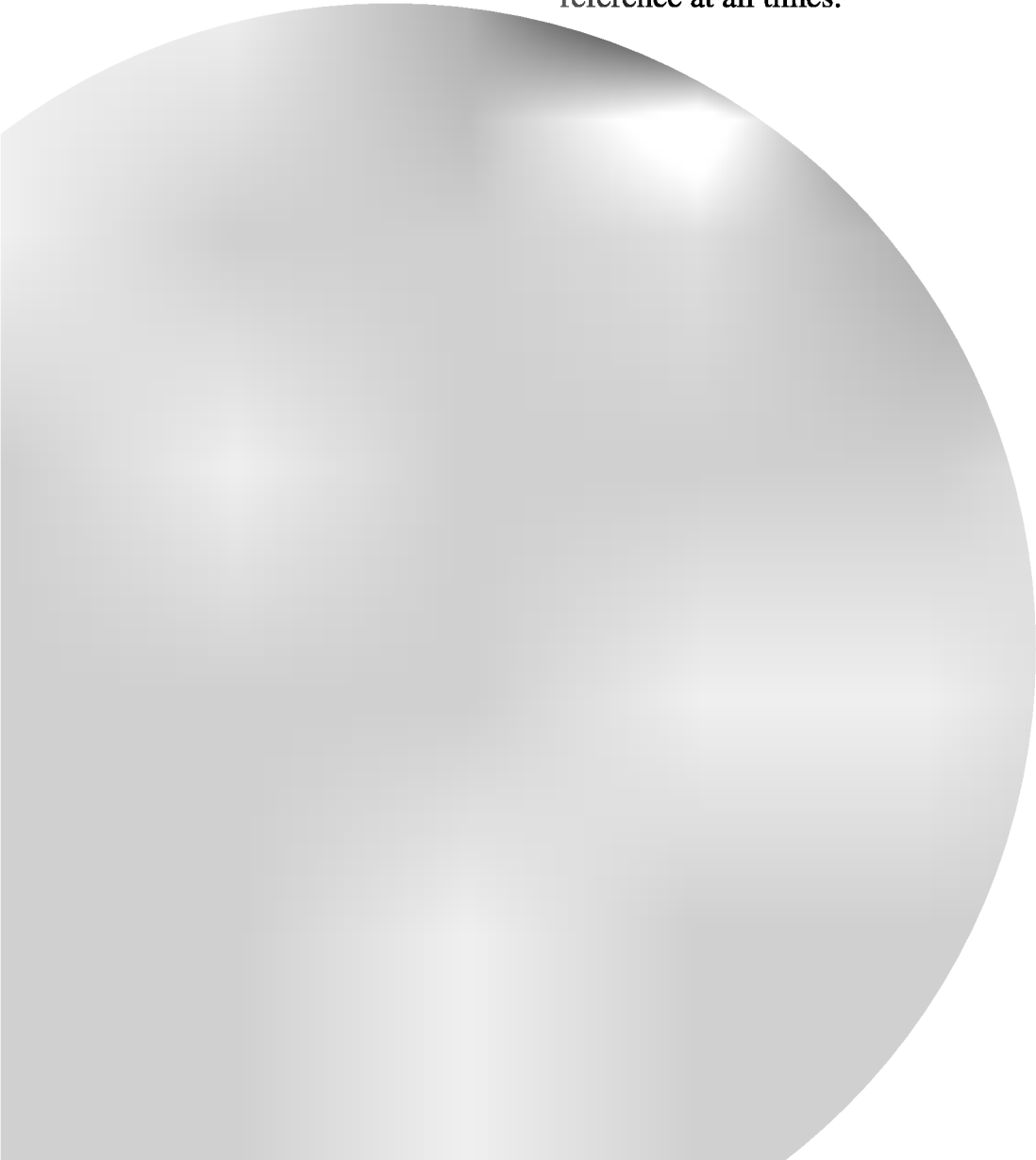

SXS REFRIGERATOR

User's Guide

Please read this guide thoroughly before operating and keep it handy for reference at all times.



(In the UK Only)

Important

The wires in this mains lead are coloured in accordance with the following code :

GREEN AND YELLOW : EARTH
BLUE : NEUTRAL
BROWN : LIVE

This appliance must be earthed

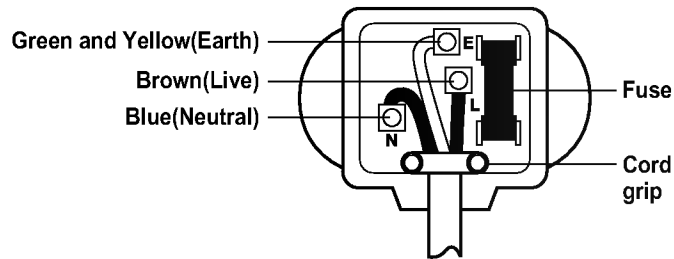

As the colours of the wires in the mains lead of this apparatus may not correspond with the coloured markings identifying the terminals in your plug, proceed as follows :

The wire which is coloured Green and Yellow must be connected to the terminal in the plug which is marked with the letter E or by the earth symbol(b) or coloured Green or Green and Yellow.

The wire which is coloured Blue must be connected to the terminal which is marked with the letter N or coloured Black.

The wire which is coloured Brown must be connected to the terminal which is marked with the letter L or coloured Red.

If a 13 amp(BS 1363) plug is used, fit a 13 amp BS 1362 fuse.

Table of contents

| | | |
|---------------------------------------------|-----------------------------------------------------|---|
| Introduction | Entry | ● |
| | Important safety instruction | ● |
| | Identification of parts | ● |
| Installation | Where to locate | ● |
| | Door removal | ● |
| | Door replacement | ● |
| | Height adjustment | ● |
| Operation | Starting | ● |
| | Adjusting the temperatures and functions | ● |
| | Shelf | ● |
| | Refreshment center (Applicable to some models only) | ● |
| | Ice making | ● |
| | Wine holder (Applicable to some models only) | ● |
| | Egg box | ● |
| | Humidity control in the vegetable compartment | ● |
| | Convert into a vegetable or meat compartment | ● |
| Deodorizer (Applicable to some models only) | ● | |
| Suggestion on food storage | Location of foods | ● |
| | Storing foods | ● |
| Care and maintenance | How to dismantle parts | ● |
| | General information | ● |
| | Cleaning | ● |
| | Trouble shooting | ● |

Entry

The model and serial numbers are found on the inner case or back of refrigerator compartment of this unit. These numbers are unique to this unit and not available to others. You should record requested information here and retain this guide as a permanent record of your purchase. Staple your receipt here.

Date of purchase : _____
Dealer purchased from : _____
Dealer address : _____
Dealer phone no. : _____
Model no. : _____
Serial no. : _____

Important safety instruction

This refrigerator must be properly installed and located in accordance with the installation instructions before it is used.

Never unplug your refrigerator by pulling on the power cord. Always grip plug firmly and pull straight out from the outlet.

When moving your appliance away from the wall, be careful not to roll over or damage the power cord.

After your refrigerator is in operation, do not touch the cold surfaces in the freezer compartment, particularly when hands are damp or wet. Skin may adhere to these extremely cold surfaces.

Unplug the power cord from the power plug for cleaning or other cares. Never touch it with wet hands because you can get an electric shock or be hurt.

Never damage, process, severely bend, pull out, or twist power cord because power cord damage may cause a fire or electric shock. You have doubts on whether the appliance is properly grounded.

Never place glass products in the freezer because they may be broken when their inner matters are frozen.

The appliance is not intended for use by young children or infirm persons without supervision.

Young children should be supervised to ensure that they do not play with the appliance.

If possible, connect the refrigerator to its own individual electrical outlet to prevent it and other appliances or household lights from causing an overload that could cause a power outage.

The refrigerator-freezer should be so positioned that the supply plug is accessible for quick disconnection when accident happens.

If the supply cord is damaged, it must be replaced by the manufacturer or its service agent or a similarly qualified person in order to avoid a hazard.

Don't use an extension cord

Accessibility of Supply Plug

Supply Cord Replacement



Child entrapment warning

DANGER : Risk of child entrapment.

Before you throw away your old refrigerator or freezer :

Take off the doors

Leave the shelves in place so that children may not easily climb inside.

The appliance is not intended for use by young children or infirm persons without supervision.

Young children should be supervised to ensure that they do not play with the appliance.

Don't store

Don't store or use gasoline or other flammable vapor and liquids in the vicinity of this or any other appliance.

Grounding (Earthing)

In the event of an electric short circuit, grounding (earthing) reduces the risk of electric shock by providing an escape wire for the electric current.

In order to prevent possible electric shock, this appliance must be grounded. Improper use of the grounding plug can result in an electric shock. Consult a qualified electrician or service person if the grounding instructions are not completely understood, or if you have doubts on whether the appliance is properly grounded.

Identification of parts

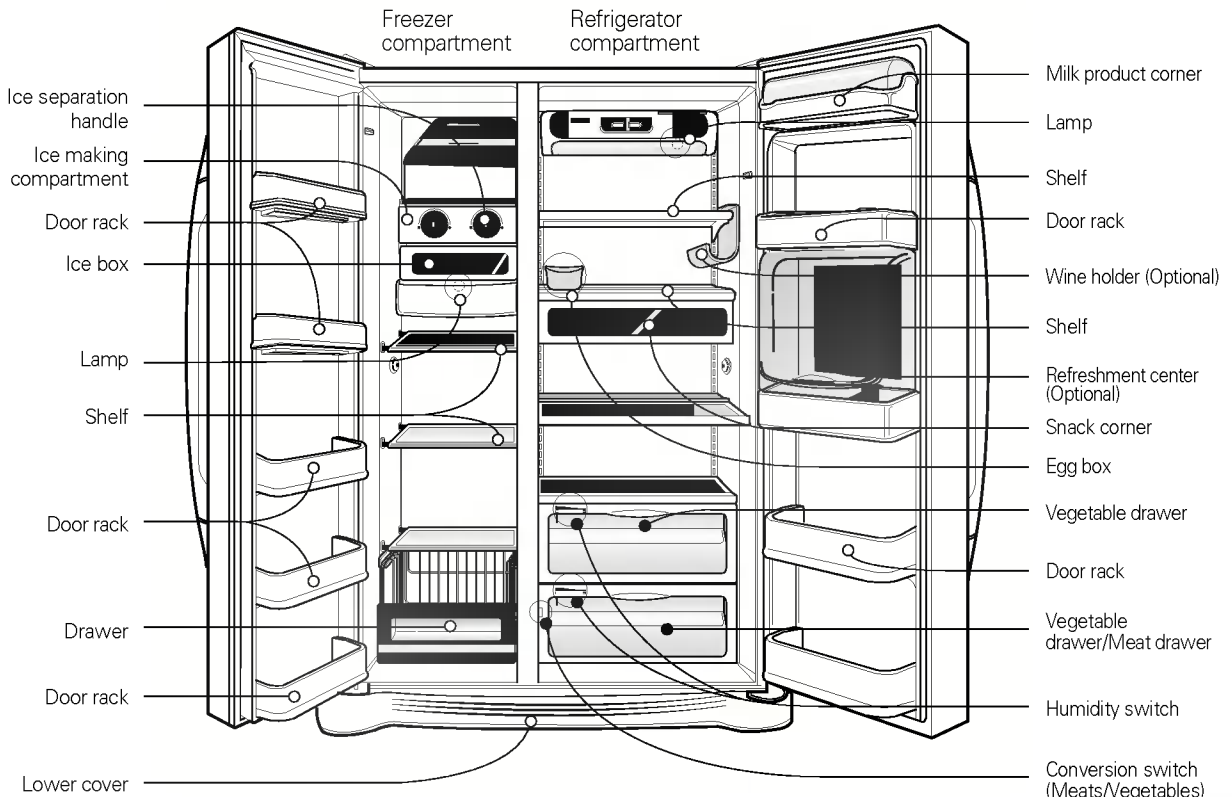

NOTE

- If you find some parts missing from your unit, they may be parts only used in other models.

Select a good location

Where to locate

1. Place your appliance where it is easy to use.

2. Avoid placing the unit near heat sources, direct sunlight or moisture.

3. Air must circulate properly around your appliance to ensure efficient operation. If your appliance is placed in a recessed area in the wall, allow at least a 12 Inches (30 cm) or greater clearance above the appliance and 2 inches (5 cm) or more from the wall. The appliance should be elevated 1 inch (2.5 cm) from the floor, especially if it is carpeted.

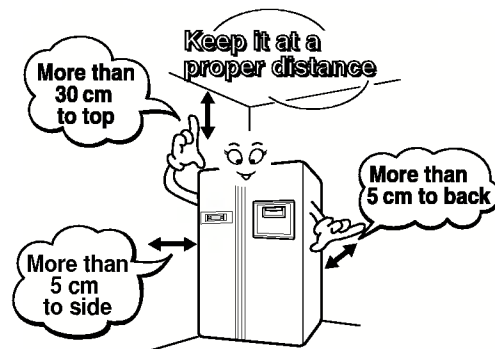

4. To avoid vibrations, the appliance must be leveled.

5. Don't install the appliance below 5°C. It may cause affect the performance.

Door removal

Warning

Electric Shock Hazard

Disconnect electrical supply to refrigerator before installing. Failure to do so could result in death or serious injury.

If your access door is too narrow for the refrigerator remove the refrigerator door and pass the refrigerator laterally.

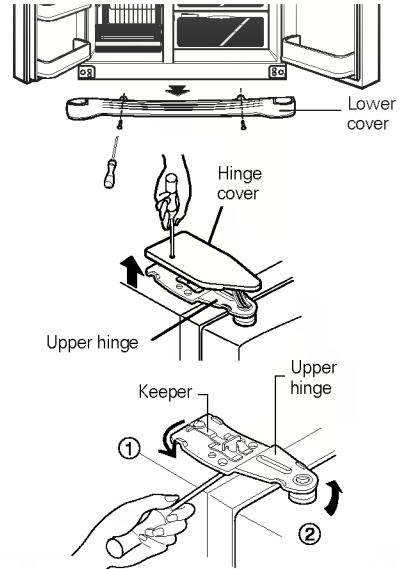

Remove lower cover

Remove the lower cover by lifting upward.

Remove the freezer compartment door

- 1) Loosen the hinge cover screws and remove the cover.
- 2) Remove the keeper by rotating it to counter clockwise (①) and then lifting the upper hinge up (②).

NOTE

- When removing the upper hinge, be careful that the door does not fall forwards.

- 3) Remove the freezer compartment door by lifting it upward.

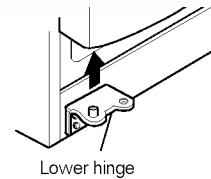

Remove the refrigerator door

- 1) Loosen the hinge cover screws and remove the cover. Remove connection wire if any, except for the earth line.

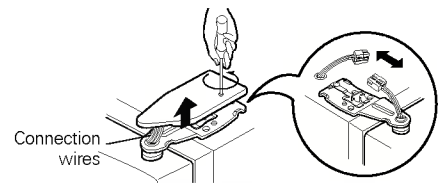

- 2) Remove keeper by rotating it clockwise (①) and then remove upper hinge by lifting it up (②).

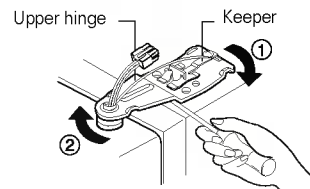

- 3) Remove refrigerator compartment door by lifting up.

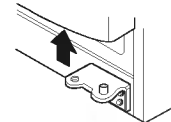

Pass the refrigerator

Pass the refrigerator laterally through access door as shown in the right figure.

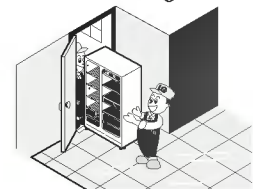

Door replacement

Mount them in the reverse sequence of removal after they pass through the access door.

Height adjustment

Level the door by inserting flat (- type) driver into the groove of the left height adjusting screw and rotate it to the arrow direction (↺).

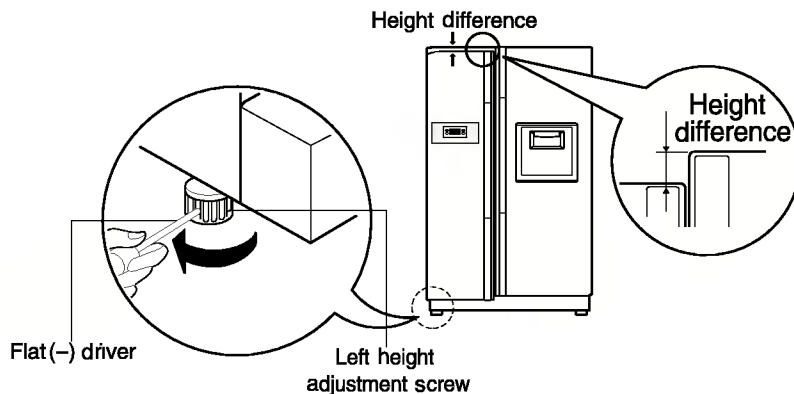

If the freezer compartment door is lower than the refrigerator compartment door

If the freezer compartment door is higher than the refrigerator compartment door

Level the door by inserting flat (- type) driver into the groove of the right height adjusting screw and rotate it to the arrow direction (↺).

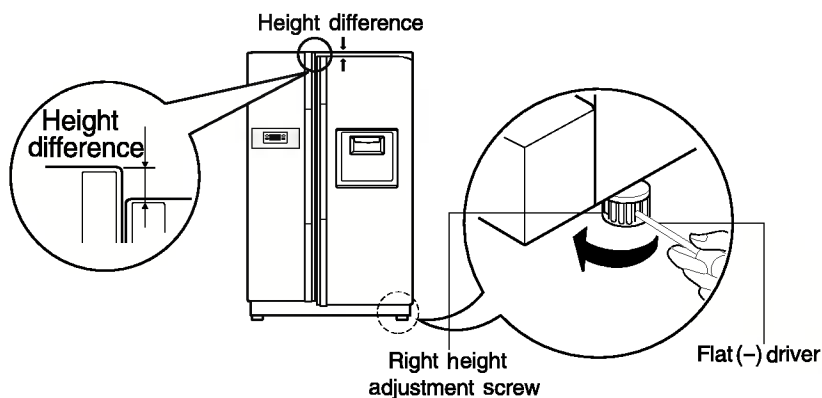

After leveling the door height

The refrigerator doors will close smoothly by heightening the front side by adjusting the height adjusting screw. If the doors do not close correctly, performance may be affected.

Next

1. Wipe off all dust accumulated during shipping and clean your appliance thoroughly.
2. Install accessories such as the wine corner, cover evaporating tray, etc., in their proper places. They are packed together to prevent possible damage during shipping.
3. Connect the power supply cord (or plug) to the outlet. Don't double up with other appliances on the same outlet.
4. Prior to use, let the appliance run for 2-3 hours. Check the flow of cold air in the freezer compartment to ensure proper cooling has taken place. Your appliance is now ready for use.

You can adjust temperature of and freezer room and refrigerator room.

How to adjust the temperature in the freezer compartment

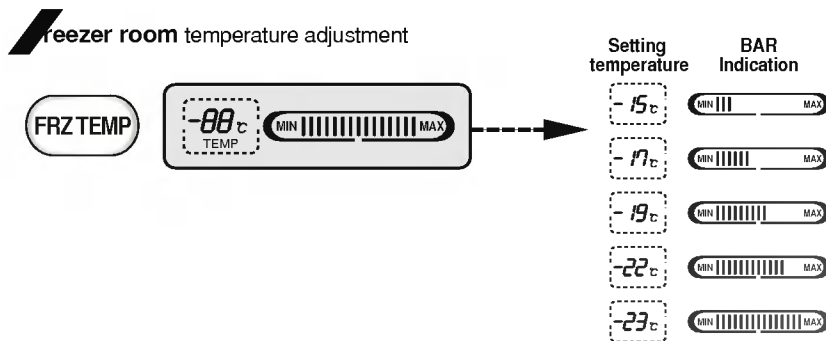

How to adjust the temperature in the refrigerator compartment

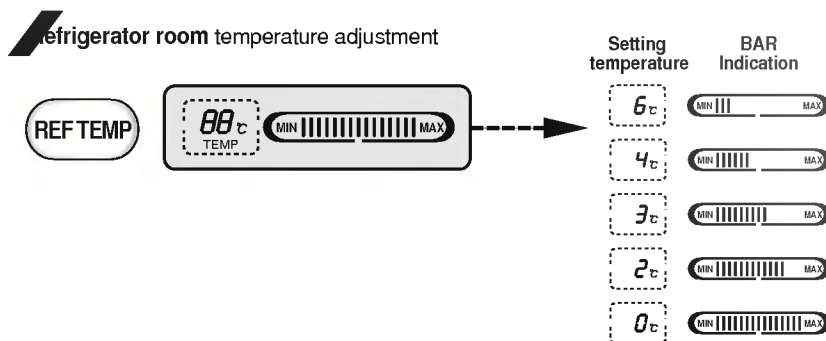

* Whenever pressing button, setting is repeated in the order of (Middle) → (Middle Strong) → (Strong) → (Weak) → (Middle Weak).

- The actual inner temperature varies depending on the food status, as the indicated setting temperature is a target temperature, not actual temperature within refrigerator.
- Refrigeration function is weak in the initial time. Please adjust temperature as above after using refrigerator for minimum 2~3 days.

Super freezer

Please select this function for prompt freezer.

- "On" or "Off" is repeated whenever pressing **SUPER FRZ** button.
- The arrow mark graphic remains at the On status after flickering 4times when selecting Special Refrigeration "On".
- Super freezer function automatically turns off if a fixed time passes.

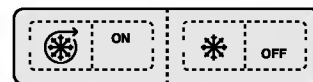

Ex) In selecting "On"

Ex) In selecting "Off"

Lock

This button stops operation of different button.

- Locking or Release is repeated whenever pressing the **LOCK**.
- Pressing the other button when selecting 'LOCK', the button does not operate.

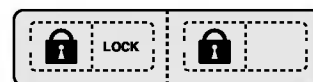

Ex) In selecting "LOCK"

Ex) In selecting "LOCK" again

The other functions

Ambient temperature display window.

- Temperature is displayed only by -9 °C ~ 49 °C.
- Temperature less than -10 °C is indicated with 'LO' and temperature more than 50 °C is indicated with 'HI'.
- Temperature may differ from the actual ambient temperature as it monitors on the upper part of refrigerator (top of door).

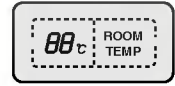

Door open warning

- 3 times of warning sounds at the interval of 30 seconds if a minute passes with the door of refrigerator and the hombar door opened or completely closed.
- Please contact with the local service center if warning continue to sound even after closing the door.

Diagnosis (failure detection) function

- Diagnosis function automatically detects failure when failure is found in product during the use of refrigerator.
- If failure occurs at product, it does not operate though pressing any button and normal indication is not done. In this case, do not turn power off but immediately contact with the local service center. A lot of time are need for service engineer to detect the failed part if turning it off.

Door open alarm

An alarm will sound 3 times when the refrigerator door is left open for more than 1 minute. This alarm will be rung at an intervals of 30 sec. and stop at the close of the door. If the alarm sound does not stop even after the freezer and refrigerator compartment doors are closed, contact the service center.

Self-diagnosis (fault detection) function

Self-diagnosis function operates when a problem occurs in the unit. When an error occurs in the unit. Immediately contact the service center without turning the power OFF. If the power is OFF, it will take the engineer longer to find out where the fault occurs.

The pressing of any function buttons will not alter the temperature setting when a fault occurs.

Shelf height adjustment

Shelf

The refrigerator compartment shelf is movable so that you can place it at a height according to space requirement of foods.

How to separate a shelf :

Lift a shelf incling to ① direction, and then separate it lifting to ② direction.

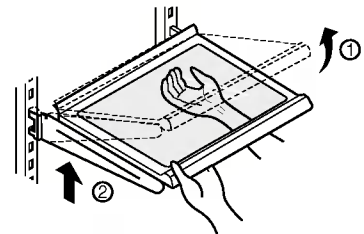

How to install a shelf :

Position a shelf to a desirable height and push into the grooves. Then lower the front side of the shelf and push into grooves.

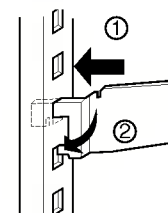

NOTE

- Make sure the shelf is horizontal. If not it may drop.

Refreshment center (Applicable to some models only)

How to use

Open the refreshment center door.

- You can access the refreshment center without opening refrigerator door and thus saving electricity.
- Inner lamp is lit in refrigerator compartment when the refreshment center door opens. Thus it is easy to identify the contents.

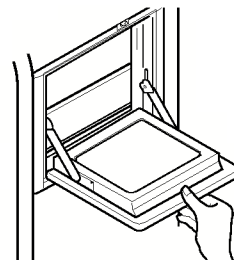

Store frequently used foods, such as beverages in the refreshment center.

- The refreshment center is kept at a correct temperature thanks to a temperature sensor only for the refreshment center.

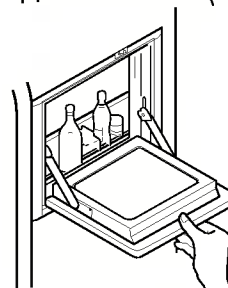

Use the refreshment center door as a stand

- Never use the refreshment center door as a chopping board and take care not to damage it with sharp tools.
- Never rest your arms or severely press on it.

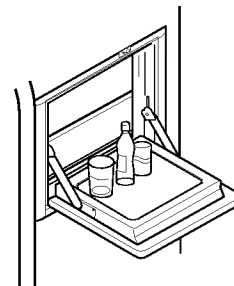

Never take out the inner refreshment center cover

- The refreshment center can not function normally without the cover.

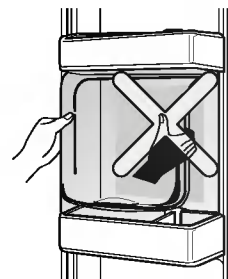

Never place heavy items on the refreshment center door or allow children to hang it on.

- Not only can the refreshment center door may be damaged, but also children may be hurt.

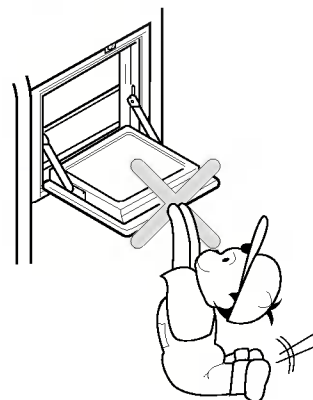

When making Ice

Ice Making

- Fill water in ice making box of the ice making corner.
If water is fully filled the ice will not be separated well and water can be dropped to make ice lumped.

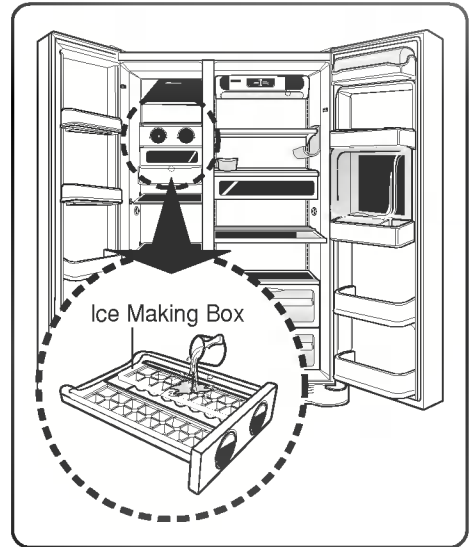

- Ice will be dropped into the ice storage bin by rotating ice separation handle of ice making compartment.

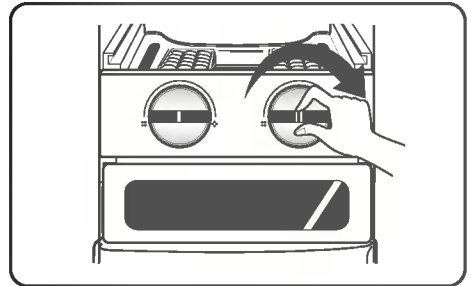

NOTE

- Rotating the ice separation handle before ice is fully frozen may cause the remaining water drop into the ice storage bin to lump the ice together.

Wine holder (Applicable to some models only)

Wine holder adjustment

Bottles can be stored laterally with this wine corner. This can be attached to any shelf.

Wine holder adjustment :

Wine holder can be separated by pulling it straight out and installed by placing it at the end of the shelf you want and pushing it inward.

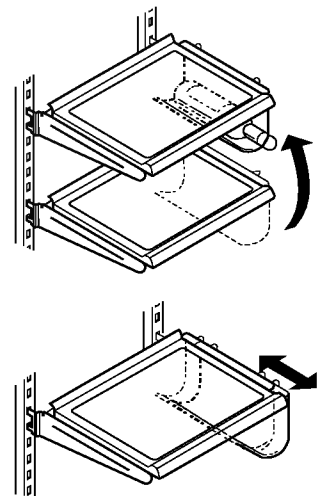

Egg box

You can move the egg box to wherever you want.

NOTE

- Never use the egg box as an ice storage bin. It can be broken.
- Never store the egg box in the freezer compartment or fresh compartment.

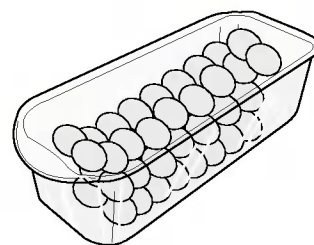

Humidity control in the vegetable compartment

The humidity can be controlled by adjusting the humidity control switch to the left/right when storing vegetables or fruits.

High humidity

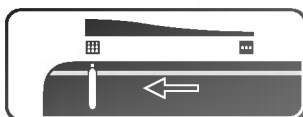

Low humidity

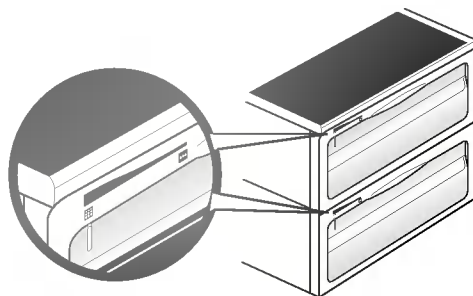

Convert into a vegetable or meat compartment

- The bottom drawer in the refrigerator can be converted into a vegetable or meat compartment

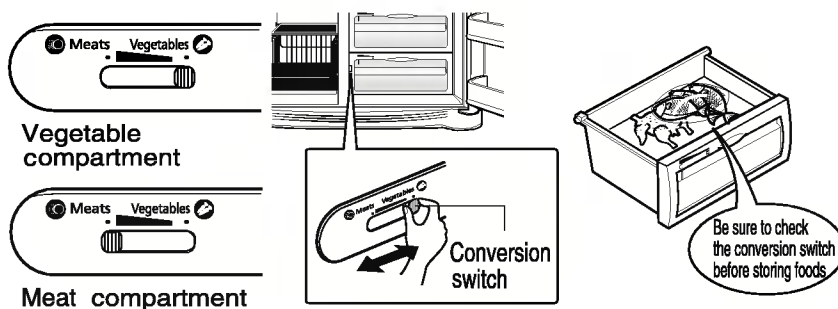

The meat compartment maintains the temperature at a lower point than the refrigerator compartment so that meat or fish can be stored fresh longer.

NOTE

- Vegetables or fruits are frozen if the conversion switch is set to meats compartment. So, be sure to check it before storing foods.

Deodorizer (Applicable to some models only)

This system efficiently absorbs strong odors by using the optical catalyst. This system does not have any effect on stored food.

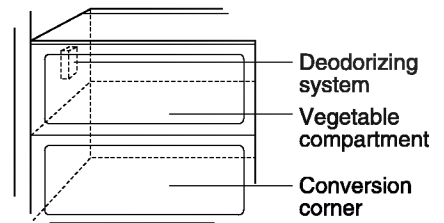

How to use the deodorizing system

- Since it is already installed onto the cool air intake duct from the refrigerator compartment, you need no separate installation.
- Please use closed containers to store food with pungent odors. Otherwise, this odor can be absorbed by other food in the compartment.

Location of foods

(Refer to identification of parts)

| | |
|--------------------------------------------------------|----------------------------------------------------------------------------------------------------------------------------------------------------------------------------------------------------|
| Wine holder | Store wine. |
| Snack drawer | Store small foods such as bread, snacks, etc.. |
| Freezer compartment shelf | Store various frozen foods such as meat, fish, ice cream, frozen snacks, etc.. |
| Freezer compartment door rack | <ul style="list-style-type: none">▪ Store small packed frozen food.▪ Temperature is likely to increase as door opens. So, do not store long-term food such ice cream, etc.. |
| Freezer compartment drawer | <ul style="list-style-type: none">▪ Store meat, fish, chicken, etc.. after wrapping them with thin foil.▪ Store dry. |
| Milk product corner | Store milk products such as butter, cheese, etc.. |
| Egg box | Place this egg box in the proper location. |
| Refreshment center | Store foods of frequent use such as beverage, etc.. |
| Refrigerator compartment shelf | Store side dishes or other foods at a proper distance. |
| Refrigerator compartment door rack | Store small packed food or beverages such as milk, juice, beer, etc.. |
| Vegetable drawer | Store vegetables or fruits. |
| Vegetable drawer /meat drawer conversion corner | Store vegetable, fruits, meat to thaw, raw fish, etc.. setting the conversion switch as necessary. Be sure to check the conversion switch setting before storing foods. |

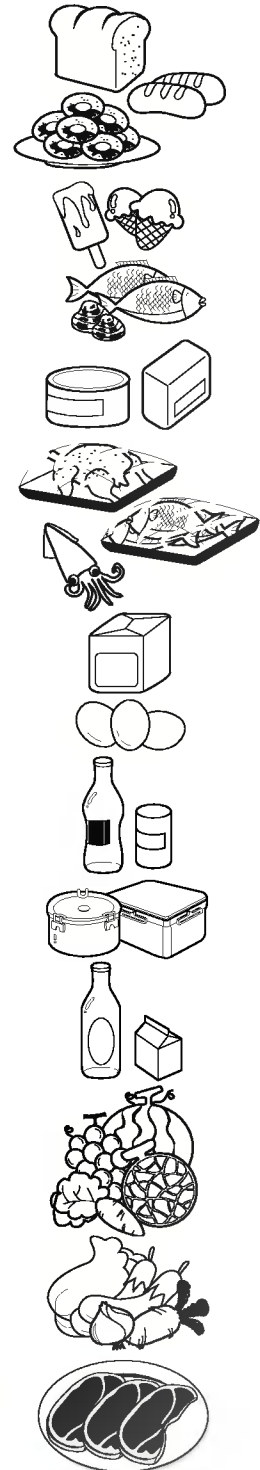

Storing foods

- Store fresh food in the refrigerator compartment. How food is frozen and thawed is an important factor in maintaining its freshness and flavor.
- Do not store food which goes bad easily at low temperatures, such as bananas, and melons.
- Allow hot food to cool prior to storing, placing hot food in the refrigerator could spoil other food, and lead to higher electric bills.
- When storing the food, cover it with vinyl wrap or store in a container with a lid. This prevents moisture from evaporating, and helps food to keep its taste and nutrients.
- Do not block air vents with food. Smooth circulation of chilled air keeps refrigerator temperatures even.
- Do not open the door frequently. Opening the door lets warm air enter the refrigerator, and cause temperatures to rise.
- Never keep too many foods in door rack because they may be interrupted by inner racks so that the door cannot be fully closed.

Freezer compartment

- Do not store bottles in the freezer compartment - they may break when frozen.
- Do not refreeze food that has been thawed. This causes loss of taste and nutrition.
- When storing frozen food like ice cream for a long period, place it on the freezer shelf, not in the door rack.

Refrigerator compartment

- Avoid placing moist food upmost refrigerator shelves, it could freeze upon direct contact with chilled air.
- Always clean food prior to refrigeration. Vegetables and fruits should be washed and wiped, and packed food should be wiped, to prevent adjacent food from spoiling.
- When storing eggs in their storage rack or box, ensure that they are fresh, and always store them in a up-right position, which keeps them fresh longer.

NOTE

- If you keep the refrigerator in a hot and humid place, frequent opening of the door or storing a lot of vegetables in it may cause dew to form which has no effect on its performance. Remove the dew with dust cloth free from care.

How to dismantle parts

NOTE

- Dismantling is done in the reverse sequence of assembly.
Be sure to unplug the power plug before dismantling and assembly.
Never apply severe force to dismantle parts. Parts may be damaged.

Freezer compartment lamp

Separate the lamp by pulling it out (③) while slightly striking (①) and rotating (②) the lamp cover. Turn the bulb counterclockwise. Max. 40 W bulb for refrigerator is used and can be purchased at a service center.

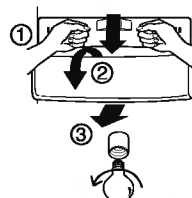

Freezer compartment shelf

To remove a shelf, lift the left part of the shelf a bit, push it to the direction ①, lift the right part to the direction ②, and take it out.

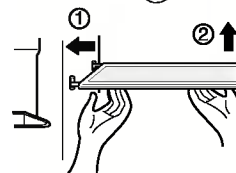

Door rack and support

Lift the door rack to ① direction holding both sides and pull it out to ② direction.

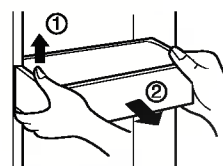

Lamp in refrigerator compartment

To remove the lamp cover, press the protrusion under the lamp cover to the front and then pull the lamp cover out. Turn the bulb counterclockwise. Max. 40 W bulb for refrigerator is used and can be purchased at a service center.

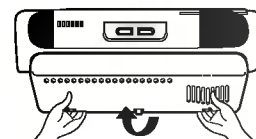

Refreshment center

- Separate the upper rack of the refreshment center and then pull out the refreshment center cover (①).
- The refreshment center can be removed by pulling it upwards.

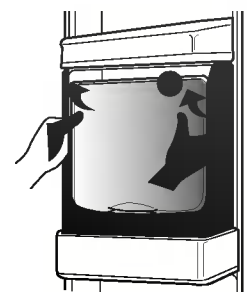

NOTE

- Be sure to remove parts from the refrigerator door when removing the vegetable compartment and snack corner.

Vegetable compartment cover

- To remove the vegetable compartment cover, pull out the vegetable compartment a bit to the front ①, lift the front part of the vegetable compartment cover as shown by ②, and take it out.

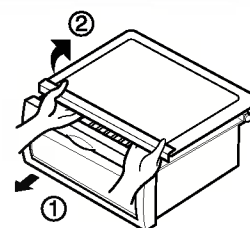

General information

| | |
|-------------------------------|--------------------------------------------------------------------------------------------------------------------------------------------------------------------------------------------------------------------------------------------------------------------------------------------------------------------------------------|
| Vacation time | <p>During average length vacations, you will probably find it best to leave the refrigerator in operation. Place freezable items in freezer for longer life.</p> <p>When you plan not to operate, remove all food, disconnect the power cord, clean the interior thoroughly, and leave each door OPEN to prevent odor formation.</p> |
| Power failure | <p>Most power failures that are corrected in an hour or two will not affect your refrigerator temperatures.</p> <p>However, you should minimize the number of door openings while the power is off.</p> |
| If you move | <p>Remove or securely fasten down all loose items inside the refrigerator.</p> <p>To avoid damaging the height adjusting screws, turn them all the way into the base.</p> |
| Anti condensation pipe | <p>The outside wall of the refrigerator cabinet may sometimes get warm, especially just after installation.</p> <p>Don't be alarmed. This is due to the anti-condensation pipe, which pumps hot refrigerator to prevent "sweating" on the outer cabinet wall.</p> |

Cleaning

It is important that your refrigerator be kept clean to prevent undesirable odors. Spilled food should be wiped up immediately, since it may acidify and stain plastic surfaces if allowed to settle.

| | |
|-----------------------|-------------------------------------------------------------------------------------------------------------------------------------------------------------------------------------------------------------------------------------------------------------------------------------------------------------------------------------------------------------------------------------------------------------------------------------------------------------------------------------------------------------------------------------------------------------------------------------------------|
| Exterior | <p>Use a lukewarm solution of mild soap or detergent to clean the durable finish of your refrigerator.</p> <p>Wipe with a clean damp cloth and then dry.</p> |
| Interior | <p>Regular cleaning is recommended. Wash all compartments a baking soda solution or a mild detergent and warm water. Rinse and dry.</p> |
| After cleaning | <p>Please verify that the power cord is not damaged, power plug is not overheated, or power plug is well inserted into the power consent.</p> |
| Warning | <p>Always remove power cord from the wall outlet prior to cleaning in the vicinity of electrical parts (lamps, switches, controls, etc.).</p> <p>Wipe up excess moisture with a sponge or cloth to prevent water or liquid from getting into any electrical part and causing an electric shock.</p> <p>Never use metallic scouring pads, brushes, coarse abrasive cleaners, strong alkaline solutions, flammable or toxic cleaning liquids on any surface.</p> <p>Do not touch frozen surfaces with wet or damp hands, because damp object will stick or adhere to extremely cold surfaces.</p> |

Trouble shooting

Before calling for service, review this list. It may save you both time and expense. This list includes common occurrences that are not the result of defective workmanship or materials in this appliance.

| Runing of refrigerator | | |
|-----------------------------------------------|---------------------------------------------------------------------------|----------------------------------------------------------------------------------------------------------------------------------|
| Refrigerator compressor does not run. | Refrigerator control is off. | Set refrigerator control. See setting the controls. |
| | Refrigerator is in defrost cycle. | This is normal for a fully automatic defrosting refrigerator. The defrost cycle occurs periodically. |
| | Plug at wall outlet is disconnected. | Make sure plug is tightly pushed into outlet. |
| | Power outage. Check house lights. | Call local electric company. |
| Refrigerator runs too much or too long | Refrigerator is larger than the previous one you owned. | This is normal. Larger, more efficient units run longer in these conditions. |
| | Room or outside weather is hot. | It is normal for the refrigerator to work longer under these conditions. |
| | Refrigerator has recently been disconnected for a period of time. | It takes some hours for the refrigerator to cool down completely. |
| | Large amounts of warm or hot food may have been stored recently. | Warm food will cause the refrigerator to run longer until the desired temperature is reached. |
| | Doors are opened too frequently or too long. | Warm air entering the refrigerator causes it to run longer. Open the door less often. |
| | Refrigerator or freezer door may be slightly open. | Make sure the refrigerator is level. Keep food and containers from blocking door. See problem section. OPENING/CLOSING of doors. |
| | Refrigerator control is set too cold. | Set the refrigerator control to a warmer setting until the refrigerator temperature is satisfactory. |
| | Refrigerator or freezer gasket is dirty, worn, cracked, or poorly fitted. | Clean or change gasket. Leaks in the door seal will cause refrigerator to run longer in order to maintain desired temperatures. |
| | Thermostat is keeping the refrigerator at a constant temperature. | This is normal. Refrigerator goes on and off to keep the temperature constant. |

Temperatures are too cold

| | | |
|-------------------------------------------------------------------------------------------------|---------------------------------------------------------------------------------------------------------------------------|--------------------------------------------------------------------------------------------------|
| Temperature in the freezer is too cold and the refrigerator temperature is satisfactory. | Freezer control is set too cold | Set the freezer control to a warmer setting until the freezer temperature is satisfactory. |
| Temperature in the refrigerator is too cold and the freezer temperature is satisfactory. | Refrigerator control is set too cold. | Set the refrigerator control to a warmer setting |
| Food stored in drawers freezes. | Refrigerator control is set too cold. | See above solution. |
| Meat stored in fresh meat drawer freezes. | Meat should be stored at temperature just below the freezing point of water (32° F, 0° C) for maximum fresh storage time. | It is normal for ice crystals to form due to the moisture content of meat. |
| Temperatures are too warm | | |
| Temperatures in the freezer is too warm. | Freezer control is set too warm. | Set the freezer control to a colder setting until the freezer temperature is satisfactory. |
| | Refrigerator control is set too warm. Refrigerator control has some effect on freezer temperature. | Set the freezer control to a colder setting until the freezer temperature is satisfactory. |
| Temperatures in the refrigerator or freezer is too warm. | Doors are opened too frequently or too long. | Warm air enters the refrigerator/ freezer whenever the door is opened. Open the door less often. |
| | Door is open slightly. | Close the door completely. |
| | Large amounts of warm or hot food may have been stored recently. | Wait until the refrigerator or freezer has had a chance to reach its selected temperature. |
| | Refrigerator has recently been disconnected for a period of time. | A refrigerator requires some hours to cool down completely. |
| Temperature in the refrigerator is too warm and the freezer temperature is satisfactory. | Refrigerator control is set too warm. | Set the refrigerator control to a colder setting. |

| Sound and noise | | |
|--------------------------------------------------------------------|-------------------------------------------------------------------------------------------------------------|------------------------------------------------------------------------------------------------------------------------------|
| Louder sound levels when refrigerator is on. | Today's refrigerators have increased storage capacity and maintain more even temperatures. | It is normal for sound levels to be higher. |
| Louder sound levels when compressor comes on. | Refrigerator operates at higher pressures during the start of the ON cycle. | This is normal. Sound will level off as refrigerator continues to run. |
| Vibrating or rattling noise. | Floor is uneven or weak. Refrigerator rocks on the floor when it is moved slightly. | Be sure floor is level and solid and can adequately support refrigerator. |
| | Items placed on the top of refrigerator are vibrating. | Remove items. |
| | Dishes are vibrating on the shelves in the refrigerator. | It is normal for dishes to vibrate slightly. Move dishes slightly. Make sure refrigerator is level and solidly set on floor. |
| | Refrigerator is touching wall or cabinets. | Relieve or move refrigerator |
| Water/Moisture /Ice inside refrigerator | | |
| Moisture collects on inside of refrigerator walls. | Weather is hot and humid which increases rate of frost buildup and internal sweating. | This is normal. |
| | Door is slightly open. | See problem section opening/closing of doors. |
| | Door is opened too often or too long. | Open the door less often. |
| Water/Moisture /Ice outside refrigerator | | |
| Moisture forms on outside of refrigerator or between doors. | Weather is humid. | This is normal in humid weather. When humidity is lower, the moisture should disappear. |
| | Door is slightly open, causing cold air from the inside the refrigerator to meet warm air from the outside. | This time, close the door completely. |



| | | |
|------------------------------------------------|----------------------------------------------------------------------------------------|---------------------------------------------------------------------------------------------------------------------------|
| Odors in refrigerator | | |
| | Interior needs to be cleaned. | Clean interior with sponge,warm water and baking soda. |
| | Food with strong odor is in refrigerator. | Cover food completely. |
| | Some containers and wrapping paper produce odors. | Use a different container or brand of wrapping paper. |
| Opening/Closing of doors/Drawers | | |
| Door(s) will not close. | Food package is keeping door open. | Move packages that keep door from closing. |
| Door(s) will not close. (Continued) | Door was closed too hard, causing other door to open slightly. | Close both doors gently. |
| | Refrigerator is not level. It rocks on the floor when it is moved slightly. | Adjust the height adjusting screw. |
| | Floor is uneven or weak. Refrigerator rocks on the floor when it is moved slightly. | Be sure floor is level and can adequately support refrigerator. Contact carpenter to correct sagging or sloping floor. |
| | Refrigerator is touching wall or cabinets. | Relieve or move refrigerator.. |
| Drawers are difficult to move. | Food is touching shelf on top of drawer | Keep less food in drawer. |
| | Track that drawer slides on is dirty. | Clean drawer and track. |

Other Please thoroughly read this manual.





LG Electronics Inc.

LG Twin Tower, 20, Yoido-Dong,
Youngdungpo-Gu, Seoul, 150-721, Korea.
<http://www.lge.com>