

LG

intellowasher

WD 6011 C - WD 6011 CH
WD 6012 C - WD 6012 CH
WD 8011 C - WD 8011 CH
WD 8012 C - WD 8012 CH
WD 1011 C - WD 1011 CH
WD 1012 C - WD 1012 CH

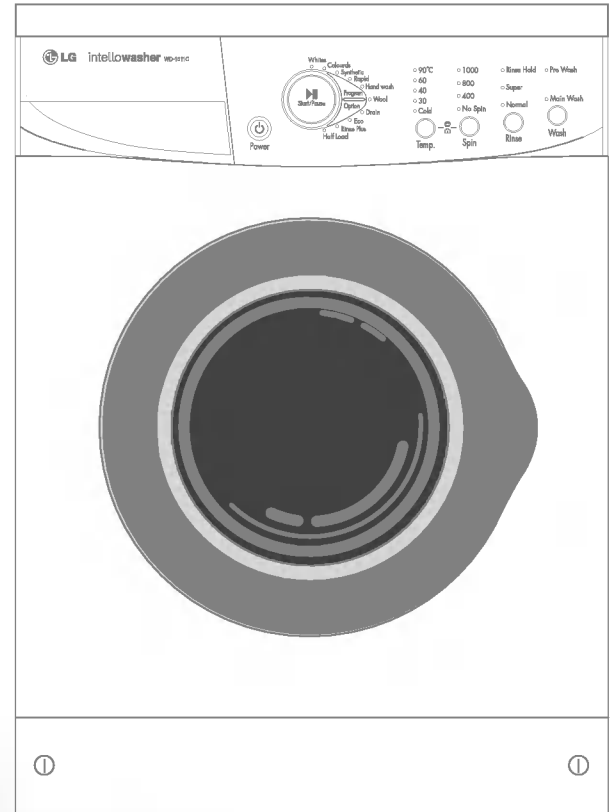

This product
has been
manufactured at
environmental
friendly modern
facilities.



Dear Customer,

We wish that this product, manufactured at modern facilities with total quality notions, will deliver you the best performance. In order to guarantee this, please read this instruction manual thoroughly and keep it for your future reference.

www.lge.co.kr



C O N T E N T S

Part 1:
Steps before operating Fullautomatic
Washing Machine and safety precautions.

Part 2:
Technical features.

Part 3:
Determining location and installation

Part 4:
Program selection and washing operations.

Part 5:
Care and Maintenance.

Part 6:
Helpful tips on stain removal

Part 7:
Before calling service.



The current requirement in order for safe operation of this machine is 16 Amperes. You will need to have a certified electrician to connect a 16 Amp fuse, if there is not enough current load.

Your washing machine is set to 220-230 Volts.

Do not forget to check the grounding in all cases of use with or without the transformer. Our company will not be responsible for any damages caused by operations without grounding.

In order to bring the machine to ready before use, please call your service technician or a certified plumber.

The performance of the washing machine depends on the effectiveness of the cleaning agent. Stains can be permanent if low quality detergents are used. Please take necessary effort to clean the stained clothes as described in following pages before washing them in the machine.

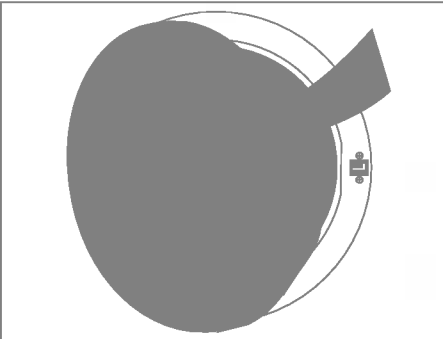

Make sure the Power switch is in the off position and always allow one to two minutes for the door safety lock to release the lock. Pull the handle to open the door.

	<p>Due to the quality control processes during production, there may be some water left over in your machine. This does not cause any damage to your product.</p>
--	---



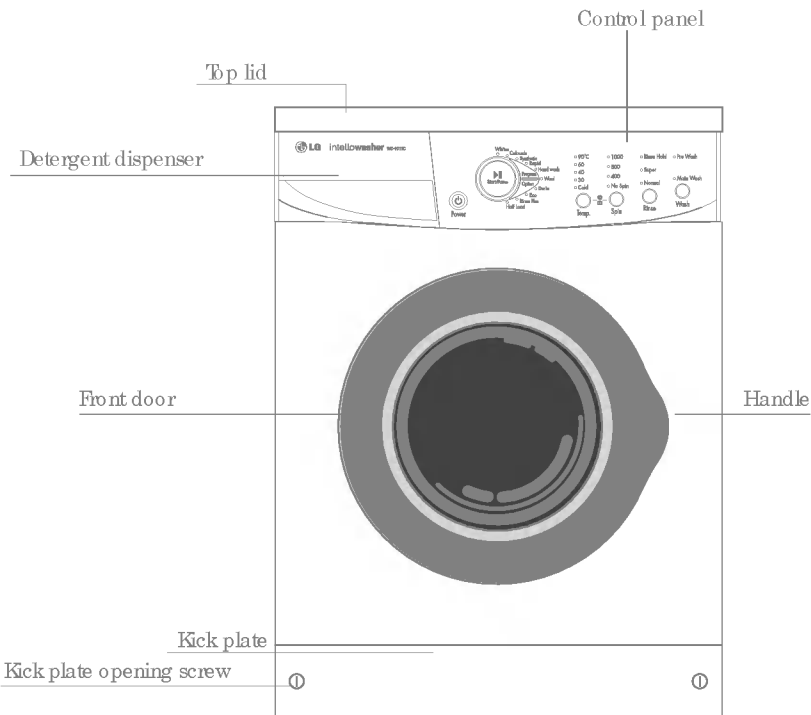

	WD 6011C WD 8011C WD 1011C WD 6011CH WD 8011CH WD 1011CH	WD 6012C WD 8012C WD 1012C WD 6012CH WD 8012CH WD 1012CH
Capacity (dry fabric)	5 kg. (11.1 lbs)	4.5 kg. (10 lbs)
Height	85 cm.	85 cm.
Width	60 cm.	60 cm.
Depth	54 cm.	45 cm.
Net weight	60 kg.	57 kg.
Power requirement	220-230 V, 50 Hz.	
Nominal current	10 A.	
Motor power	300 Watts.	
Heater power	1900 Watts.	
Washing speed	50 rpm.	
Max. Spin speed (WD 6011C - WD 6011CH WD 6012C - WD 6012CH)	600 rpm.	
(WD 8011C - WD 8011CH WD 8012C - WD 8012CH)	800 rpm.	
(WD 1011C - WD 1011CH WD 1012C - WD 1012CH)	1000 rpm.	

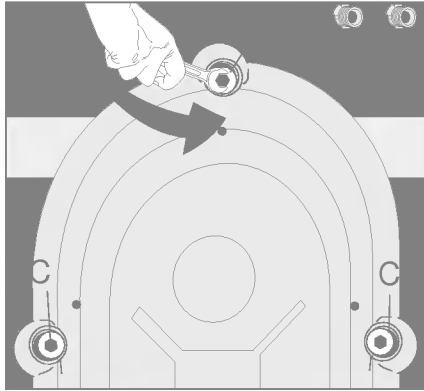

The transport safety bolts must be removed before any operation of the machine. Bolt heads, marked “C”.

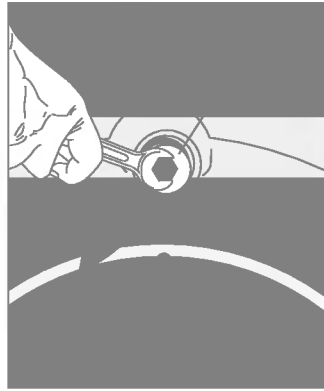

“C”, should be turned in a anti clockwise direction until the bolt can be partially withdrawn.

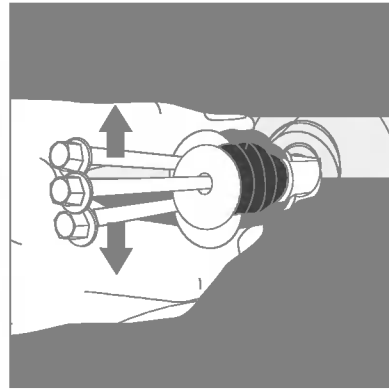

Remove transport safety bolts and rubber bushes by pulling outwards. (A up/ down action and a small squirt of washing up liquid should ease removal.)

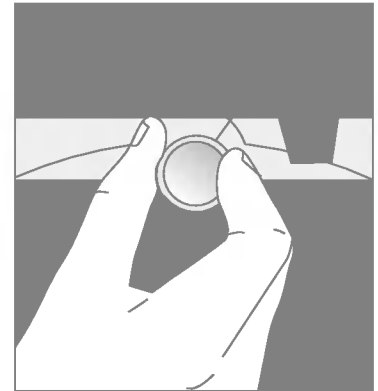

Plastic plugs, supplied inside the protective bag and designated as “P”, should be placed in the safety bolt holes according to the direction shown.



Attention!

Please keep the safety bolts for future transportation and reinstate them before transporting your machine. Never transport your machine without the transport bolts in position.

Never place your machine on a carpet. This prevents air circulation. The electrical components of the machine may overheat and may cause damage.

In order for quiet and stable operation, the machine should be placed properly and leveled on its feet. Your machine comes with two adjustable feet. If the machine is unstable, loosen the plastic counternut and screw or unscrew the adjustable foot until the machine is leveled perfectly. After positioning, tighten the counternut for stability.

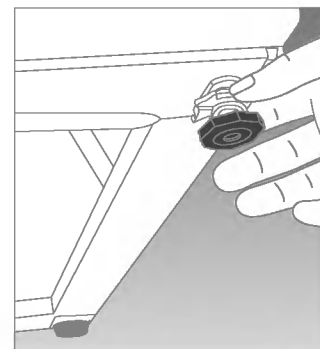

a) Water inlet hose

Cold water supply

For proper operation, the pressure of water should be between 1 and 10 atm. (1 atm corresponds to more than 8 liters per minute flow rate at fully open tap.)

To prevent water leaks sealing washers are supplied with the water inlet hose inside the machine, place these on each of the hose ends and tighten both ends fully.

In order to prevent any water leak damages, keep the water taps closed when not in use. Connect the cornered end of the hose to the machine water inlet.

Hot water supply (only for hot and cold water inlet machines)

Pressure: 1-10 bar Temperature: 60°C max. A hot water supply fed from a separate cold water tank will normally be suitable. Open outlet gas or electric water heaters must not be used. Multipoint water heaters or combination boilers may be suitable if they are designed to supply washing machines. (Check your boilers operation instructions or supplier.)

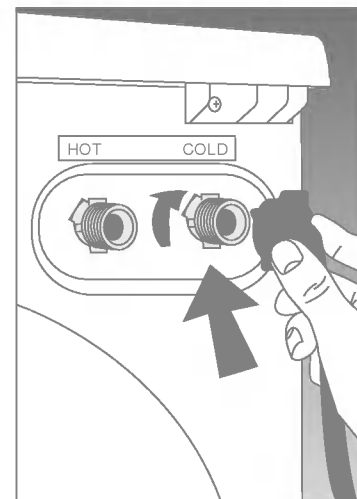

Connect the cold water using the hose with blue printing and connect the hot water using the hose with red printing.

b) Water drain hose

Water drain hose could be placed either at the side of the bath tub, or directly to the drain. The hose should not be bent. Water drain hose should be secured with the elbow so that it would not fall down on the ground.

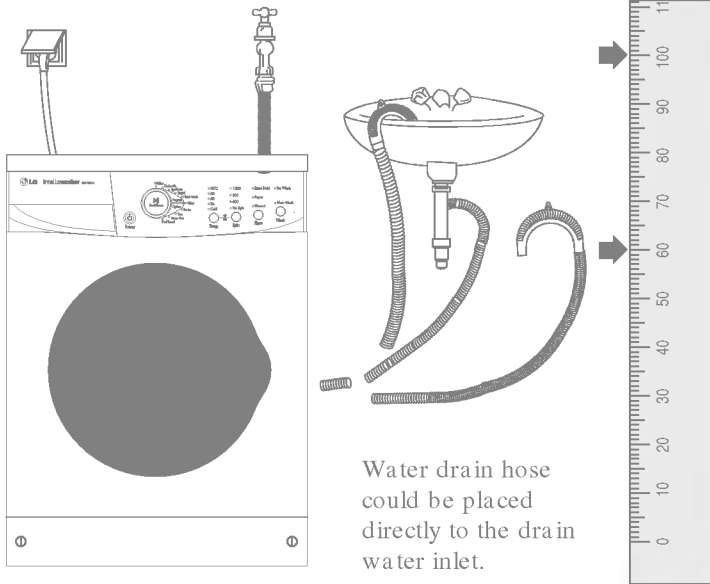
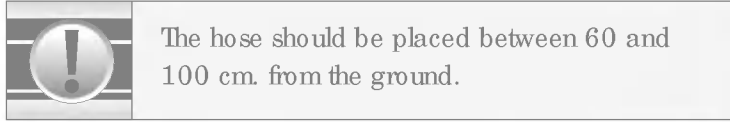

4. Electrical connection

Connect the power cord to the appropriate electrical system which is being supported by the maximum voltage and current rating indicated on the rating plate placed inside the kick plate.

Look! Page 1, Steps before operating Full automatic Washing Machine and safety precautions.

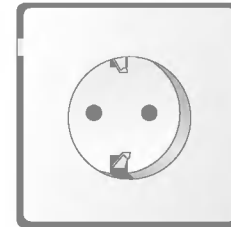

Make sure that you have grounded power outlet.

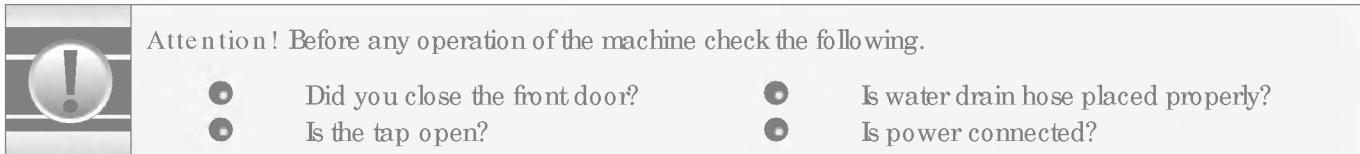



WD 1011C - WD 1011CH
WD 1012C - WD 1012CH

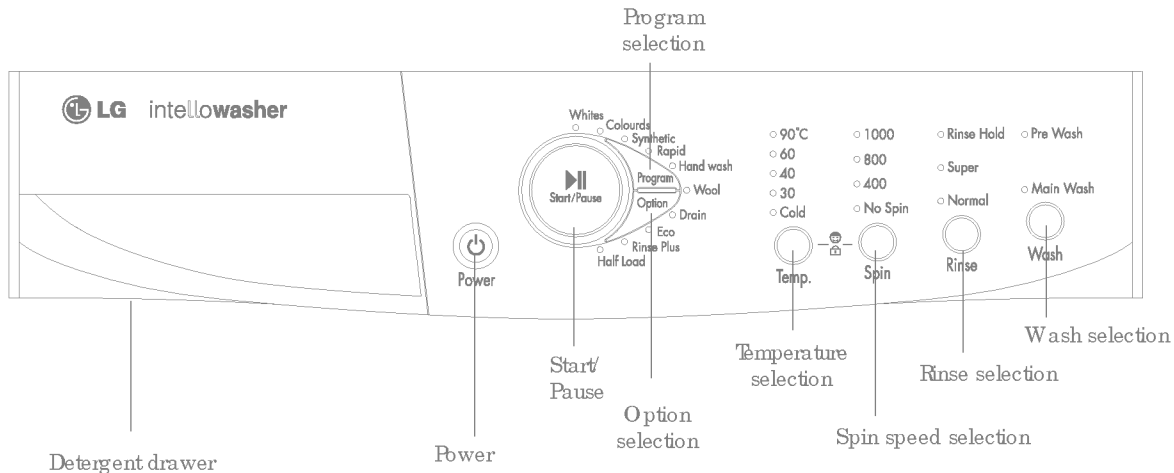

Spin speed selection for : (WD 6011C - WD 6011CH
WD 6012C - WD 6012CH)

- 600
- 500
- 400
- No Spin

Spin speed selection for : (WD 8011C - WD 8011CH
WD 8012C - WD 8012CH)

- 800
- 600
- 400
- No Spin



● Loading the machine

Place the fabrics uniformly inside the machine. Hand knits should be placed inside out in the machine. Make sure that there is no clothing at the side of the door. Close the door by pushing lightly. If the door does not close completely, the machine could not be started-a safety measure. Front door is locked until the end of the washing program and it will not be opened about 2 minutes following the end of the program.

● Sorting laundry

Sort the laundry according to the following groups and wash them separately:

- white and resistant colored fabrics,
- colored fabrics,
- delicate fabrics (silk, rayon etc.),
- wool.

Be sure to empty pockets and remove any belts, buttons, pins, etc. from the clothing. For stained fabrics, refer to the “Practical information” section of the operating manual.

● Detergent and softener selection

Choose the appropriate detergent specifically used at the full automatic washing machines. Suggested amount is given on the detergent cover. If small amount of clothing is placed in the machine and half load option is selected, put half the amount of detergent required for normal wash.

Do not attempt to use detergents and bleaching elements that contain chlor and sulphur. The amount of the detergent depends on the dirt level of fabric, the amount of fabric and the softness of the water.

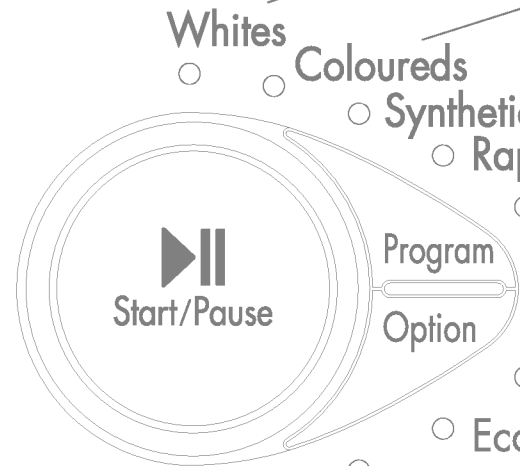

- Program for white cloths
- Program for coloured cloths
- Designed for synthetic fabrics, nylon clothing, curtains and iron free wool fabrics. Clothing are washed with more water delicately.
- Shortens washing time for lightly soiled fabrics. This function can be used for cotton and synthetic programs for temperatures below 60°C.
- This program is used for laundry that has to be washed more slowly and delicately like washable artificial silk, trousers, blouses, nylon socks, tullecurtains, child/ baby wear.
- With wool program selection wool fabrics are washed thoroughly.
- Used for drainage of the water inside the washing machine.
- Cloths will be washed at lower temperatures and longer time. This enables an economic and better wash results. Only available at 60°C and 90°C temperatures.
- By using this function your machine will add another rinse process to the three rinse processes that it has already done. This additional rinse will reduce any affects on sensitive skin by washing leftover detergent
- The most economic wash is obtained by selecting half load button if half the amount determined in the program selection table is placed in the machine.
- When half load button is selected, half of the amount of detergent should be used.



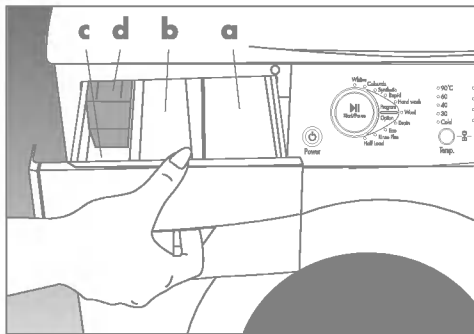

- a. Compartment I detergent compartment for prewash cycle.
- b. Compartment II detergent compartment for wash cycle.
- c. "☼" Compartment for fabric conditioner.
- d. Siphon.

Fill the fabric softener to the marking. Any excess amount of softener will mix into the wash water and you will have to re-fill the compartment. Hardened softener may clog the siphon, in this case add some water to the softener.

Temp. Selection

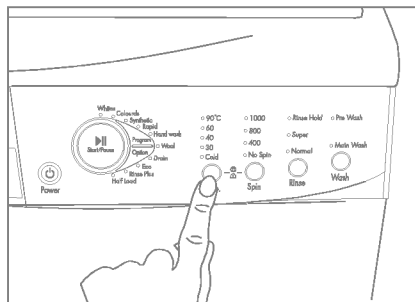

Using this button, you can select final temperature up to 90°C in whites, up to 60°C in coloureds, synthetics, up to 40°C in Hand wash, Rapid, Wool programs. If you don't want to apply heating, you can select also cold wash.

- 90°C
- 60
- 40
- 30
- Cold



Temp.

Spin Selection

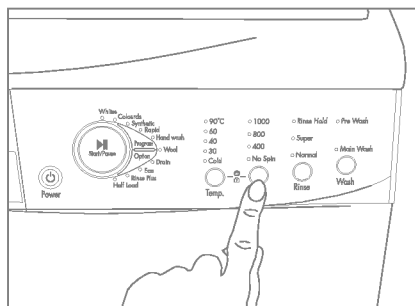

WD 1011C - WD 1011CH
WD 1012C - WD 1012CH

Using this button, you can select final spin speed upto 1000 rpm in Whites, Coloureds, Rapid and Synthetics, up to 800 rpm in Hand wash and Wool.

- 1000
- 800
- 400
- No Spin



Spin

WD 8011C - WD 8011CH
WD 8012C - WD 8012CH

Using this button, you can select final spin speed upto 800 rpm.

- 800
- 600
- 400
- No Spin



If you don't want to apply spinning to your clothes, you can select also No Spin.

WD 6011C - WD 6011CH
WD 6012C - WD 6012CH

Using this button, you can select final spin speed upto 600 rpm.

- 600
- 500
- 400
- No Spin

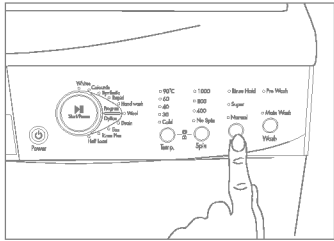

Rinse Selection

Using this button, you can select normal rinse, super rinse, normal rinse + rinse hold, super rinse + rinse hold. If you don't want to apply rinsing, you can select also no rinse, by pressing the rinse button till the leds turn off.

Rinse Hold: If you desire to leave your synthetic and wool fabrics in the machine after the wash program you may select the Rinse hold to prevent them getting wrinkled. To continue the program, you can either press the Rinse button again or select DRAIN on the option selection button to discharge the water.

Super: The rinse water levels will be increased and an extra rinse cycle is added.

Normal: Normal rinse cycle is made. (3 rinsing steps)

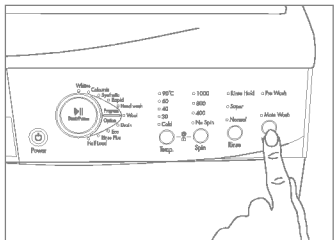

Wash Selection

Using this button, you can select only main wash, main wash with prewash or no wash. If no wash is selected by pressing the wash button till the leds turn off, the program will start with the rinse cycle.

Part 4: | Program selection and machine operation

Program selection table

PROGRAMMES	TEMP. (°C)	RINSE	PREWASH	OPTIONS **				LOAD kg.	LOAD kg.	FABRIC TYPE
				HALF LOAD	RINSE PLUS	ECO	DRAIN			
Whites	40-90	*	*	*	*	*	*	5	4.5	Heavy soiled cottons and linens
Coloureds	Cold-60	*	*	*	*	*	*	5	4.5	Normally soiled cottons and linens
Synthetic	Cold-60	*	*	*	*	*	*	2.5	2.5	Normally soiled synthetics and delicates
Hand wash	Cold-40	*		*	*		*	1.5	1.5	Lightly soiled synthetics and delicates
Rapid	Cold-40	*		*	*		*	5	4.5	Lightly soiled cottons and linens
Wool	Cold-40	*		*	*		*	1.5	1.5	Woolens

WD 6011C	WD 6012C
WD 8011C	WD 8012C
WD 1011C	WD 1012C
WD 6011CH	WD 6012CH
WD 8011CH	WD 8012CH
WD 1011CH	WD 1012CH

* Options available

** You can select only one option during a program.

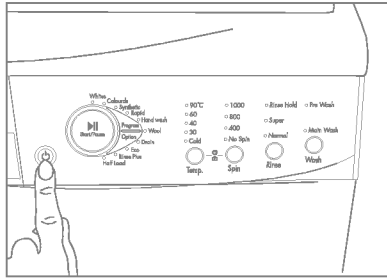

Place your clothes into the machine and close the front door. Determine the program after referring to the program selection table. Put powder detergent and the fabric softener to the compartments and close the detergent dispenser.

Push the POWER button to turn on the washing machine. Program and option leds are turn on.

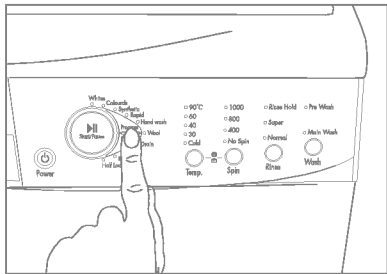

Program Selection

Pressing the Program button sequentially following programs are turn on:

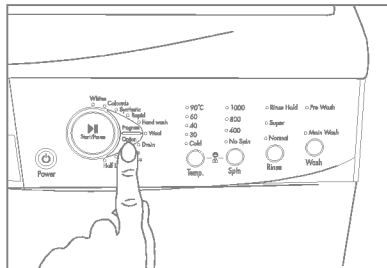

Option Selection

Pressing the Option button sequentially following options are turn on:



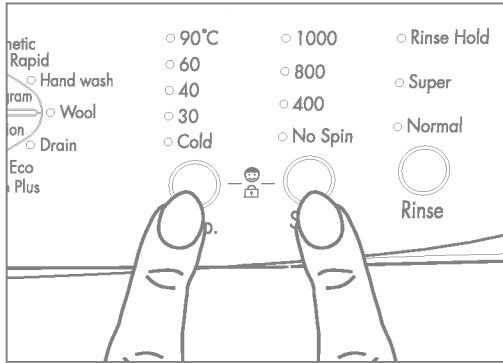

During washing, in order to prevent any interruptions during the program by mistakenly pressed buttons, there is a child-care lock, as a safety measure. To activate the child-care lock, press the Temp. and Spin buttons at the same time (for three seconds) after the washing process has been started. All the program and option leds begin to blink for certain amounts of time. The child-care lock will lock all the keys and buttons included Power button. When the program finishes, with an active child-care lock, the start/ stop button will still blink.

To open the front door at the end of the program or to interrupt the program during the process you have to deactivate the child-care lock. To deactivate the lock you have to press the Temp. and Spin buttons at the same time (for three seconds). The blinking leds, which indicates that the child lock is active, will stop blinking.

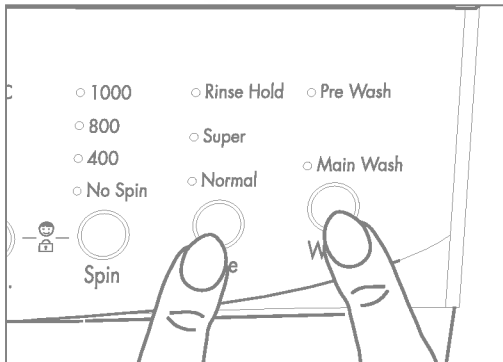

If Wash and Rinse buttons pressed same time buzzer will be off. To turn on the buzzer press again the wash and rinse buttons at the same time.

The selected program can be started by pushing the Start/ Pause button. Front door will be locked and the led indicator will go on. To stop the machine during the program press the start/ pause button again.

If fabric softener is added in the softener compartment, it will be used in the last rinse cycle. If rinse hold is selected, by re-pressing this button, you can continue the program. If no spin is desired, you may leave the rinse hold button pushed. Pause the machine, select the Drain option and Start the machine. With this operation, water in the machine will be discharged.

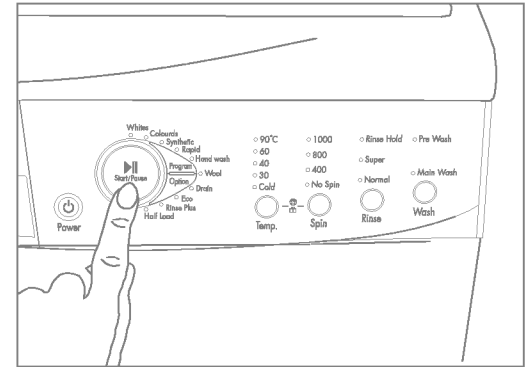

After the start of a program, the led of the ongoing program step led will turn on. The finished program step leds will turn off. As an example if main wash led is on, the machine is on the main wash step. If the 90 C led turns off, the heating is finished.

Machine stops automatically after the programs are completed, and the buzzer beeps 7 times. After 8 seconds the machine will be automatically turn off. Front door can be opened 1-2 minutes after the end of the program. Turn off the water tap. Unload the machine and leave the front door open to air the machine.



Detergent dispenser

To clean the detergent residues, remove the detergent dispenser from its place by pressing on the area marked on siphon. Wash the dispenser with water and also clean the dispenser housing before inserting the dispenser to its place.

Siphon

Clean the siphon (coloured piece in the dispenser) every 30-40 washes. Pull out the siphon by holding from its edges. To prevent clogging, clean the softener residues thoroughly and make sure that the siphon fits into its place completely before any operation.

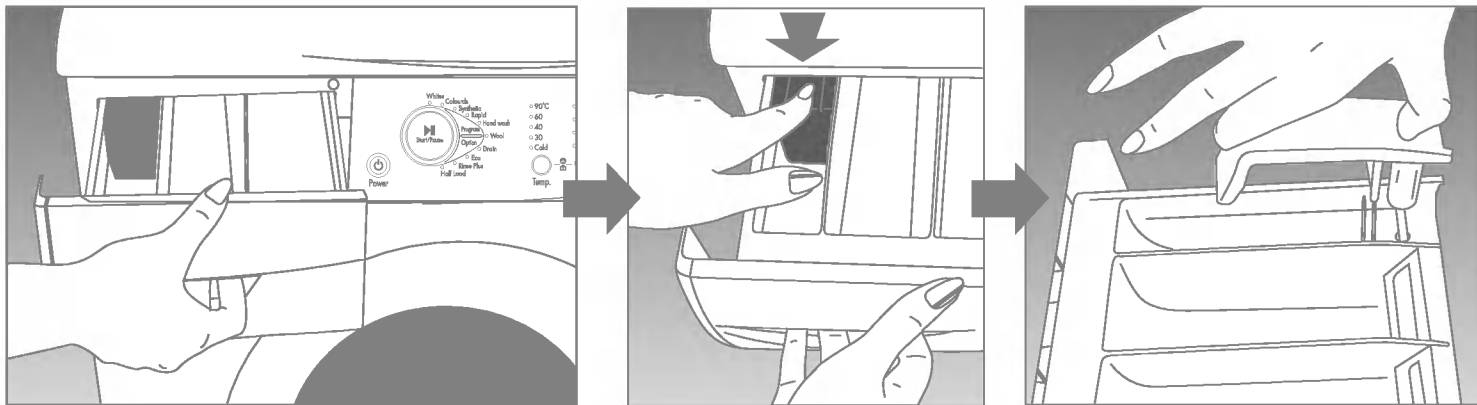

● Hoses

To prevent any leakage, have a technician to control the hoses every two years. If the machine is placed at cold ambient temperatures, the water remaining inside the pump and hoses should be removed from the filters. Also to prevent freezing, empty the water intake hoses by disconnecting from taps.

● Water intake filter

At the end of the water intake connection module and water inlet hose-tap side, there exists filters. These filters prevent any dirt and objects passing into the machine. It is advisable that these filters should be cleaned every 30-40 washes. To clean the filter, first turn the tap off. Then, disconnect the hose and clean the filter with a thin brush. If the filter is very dirty, you may clean it by pulling out with pliers. To clean the filter at the tap side of the hose, pull it out by hand and clean the filter under the tap water.

● Drum

Do not leave any metal objects (pins, needles, etc.) inside the drum. These objects may cause rust on the drum surface. Do not clean the drum with scratching elements.

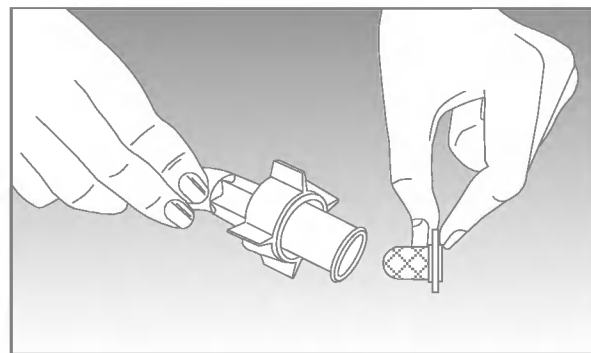
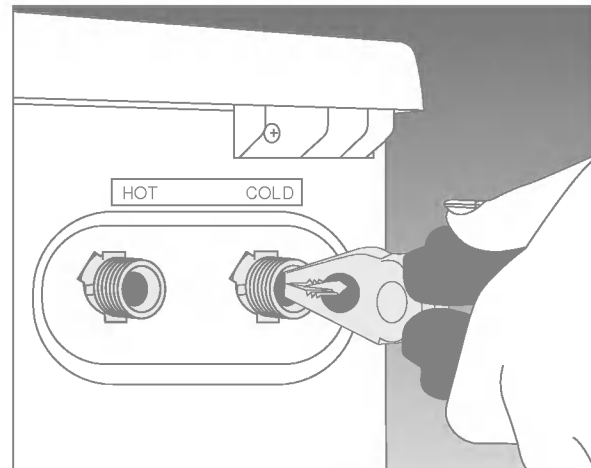

To prevent objects entering to the pump, your machine comes with a filter system that extends the pump life. It is advisable that you should clean the filter at every 30-40 washes. Before opening the filter door, disconnect the power. Turn the opening of kick plate screws 90° with a help of screw driver or a coin. Place a little pan in front of the filter door to prevent a little amount of water spilling from the machine. Remove the filter by turning it counter-clockwise direction. After cleaning the objects on the filter, place it by turning clockwise and make sure that it is closed firmly. Place the kick plate and secure it by locking the screws.

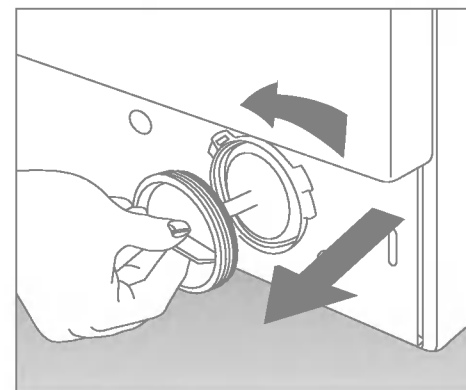
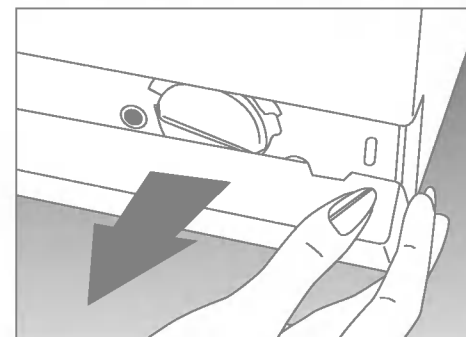
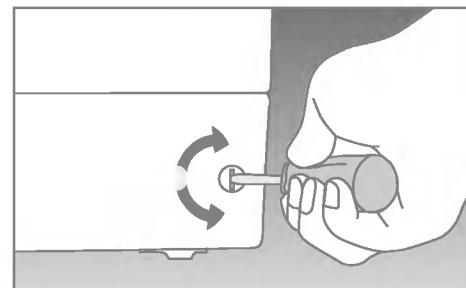

Attention! If the filter does not fit into its place, water will leak out from the filter.



Part 6: | Helpful tips on stain removal

The following stain removing tips are approximate and can only be used at the washable fabrics. Please consult the washing information of the fabric manufacturer.

Ratios are approximated.



Alcoholic beverages: Wipe the fabric first with water, then water-glycerine solution and rinse with vinegar-water solution.



Shoe polish: Without harming the fabric, remove the stain carefully and grind it with detergent. If this doesn't help, prepare a water to alcohol solution (2 to 1) and rub the fabric, then wash it with warm water.



Tea and coffee: Pour hot water on to the stain and the fabric is white, pour some bleach and rinse it with water.



Bubblegum: Harden the gum stain by putting an ice on it. Then scrape off the stain carefully.



Chocolate and cocoa: Place the fabric into cold water for a period of time. Rub it with soap or detergent and wash it with the warmest water that the fabric can withhold. If any grease stain leftover wipe it with oxygen water.



Tomato paste: Scrape the hardened paste and leave the fabric for 40 minutes into cold water. Rub it with detergent and wash.



Egg stain: If the stain is hardened scrape the stain and wipe it with wet sponge or a soft cloth. Rub it with detergent and wash with cold water.



Grease stain: Scrape the stain and rub it with detergent. Then wash the fabric with warm water.



Mustard: Use glycerin and rub the fabric with detergent. If unsuccessful, wipe the stain with alcohol. (Colored and synthetic fabrics need 2 cups water and 1 cup alcohol solution.)



Blood stain: Leave the fabric for 30 minutes in the cold water. Use ammonia solution to remove the stain. (4 liters water-3 spoonful of ammonia.)



Ice-cream, milk and cream: Place the fabric into cold water for a period of time. Rub it with soap or detergent and wash it with the warmest water that the fabric can withhold. If any grease stain leftover wipe it with oxygen water.



Mildew: Do not let mildew stains stay for long periods of time. Place the fabric into cold water for a period of time. Rub it with soap or detergent and wash it with the warmest water that the fabric can withhold. If any grease stain leftover wipe it with oxygen water.



Fruit: Pour cold water on to the stain and do not use warm water to rinse. Let it sit for 2 hours and wipe it with white vinegar and rinse.



Ink: Let the cold water run on the stain and wait until the stain is gone. Later rub it with lemon juice and detergent, let the stain stay for five minutes and rinse the fabric.



Grass stain: Rub the stain with detergent. If the fabric lets, use bleaching element. Wools should be wiped with alcohol.



Paint: Use thinner to remove the stain. Put a cotton cloth on the wool fabrics. Rub the stain with detergent and rinse with cold water.



Burnt stains: Use bleach if permissible. For wool fabrics place a oxygen water inserted cotton cloth on the stain and iron. Rinse completely and wash the fabric.



You turned the machine on, but the leds are off on the panel.
Check the grounding on the power cable or a blown fuse.
Check the front door proper closure.



Water coming from beneath the machine.
Check the water intake and drain hoses. Tighten the connections.
The washers of the hoses may be worn out. If non of the both, the pump filter is not closed properly.

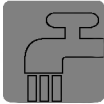

Machine does not take water.
Check the front door for proper closure. Either taps are closed or water intake filters are clogged.



Foam coming out of the detergent dispenser.
Check whether your detergent is suitable for automatic machines.
Next time use less detergent.



Taken water is directly discharged.
Check if the discharge hose planced as described in page 8 or not



Pump does not drain water.
Clean the pump filter. Check whether the drain hose is bent or not. If there is need to clean the pump filter; refer to the pump filter cleaning section of the manual.

r

symbols



Washing temperature



Bleach can be used



Do not use bleach



Do not machine wash



Dry on horizontal surface



Do not wash



Dry clean



Chemicals can be used



No dry cleaning



No spin



Can be washed at centrifugal machine



Do not wash centrifugal machine



line dry



Iron permitted



Do not iron



Warm iron

