



PORTABLE DVD PLAYER

OWNER'S MANUAL

MODEL: DP4932N



MP3



Before connecting, operating or adjusting this product,
please read this instruction booklet carefully and
completely.

Safety Precautions

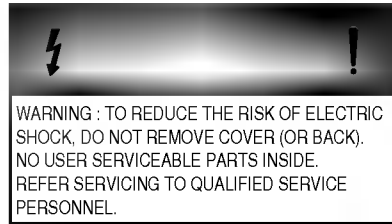

The lightning flash with arrowhead symbol, within an equilateral triangle, is intended to alert the user to the presence of uninsulated 'dangerous voltage' within the product's enclosure that may be of sufficient magnitude to constitute a risk of electric shock to persons.



The exclamation point within an equilateral triangle is intended to alert the user to the presence of important operating and maintenance (servicing) instructions in the literature accompanying the appliance.

WARNING: TO REDUCE THE RISK OF FIRE OR ELECTRIC SHOCK, DO NOT EXPOSE THIS PRODUCT TO RAIN OR MOISTURE.

CAUTION: TO PREVENT ELECTRIC SHOCK, MATCH WIDE BLADE OF PLUG TO WIDE SLOT, FULLY INSERT.

ATTENTION: POUR EVITER LES CHOCS ELECTRIQUE, INTRODUIRE LA LAME LA PLUS LARGE DE LA FICHE DANS LA BORNE CORRESPONDANTE DE LA PRISE ET POUSSER JUSQU'AU FOND.

CAUTION: This Digital Video Disc Player employs a Laser System. To ensure proper use of this product, please read this owner's manual carefully and retain for future reference, should the unit require maintenance, contact an authorized service location-see service procedure. Use of controls, adjustments or the performance of procedures other than those specified may result herein hazardous radiation exposure.

To prevent direct exposure to laser beam, do not try to open the enclosure. VISIBLE AND INVISIBLE LASER RADIATION WHEN OPEN. DO NOT STARE INTO BEAM OR VIEW DIRECTLY WITH OPTICAL INSTRUMENTS

FCC WARNING: Changes or modifications not expressly approved by Zenith Electronics Corporation could void the user's authority to operate the equipment.

Safety Precautions (Cont'd)

FCC NOTICE: This equipment has been tested and found to comply with the limits for a Class B digital device, pursuant to part 15 of the FCC Rules. These limits are designed to provide reasonable protection against harmful interference in a residential installation.

This equipment generates, uses, and can radiate radio frequency energy and, if not installed and used in accordance with the instructions, may cause harmful interference to radio communications.

However, there is no guarantee that interference will not occur in a particular installation.

If this equipment does cause harmful interference to radio or television reception, which can be determined by turning the equipment off and on, the user is encouraged to try to correct the interference by one or more of the following measures:

- Reorient or relocate the receiving antenna.
- Increase the separation between the equipment and receiver.
- Connect the equipment into an outlet on a circuit different from that to which the receiver is connected.
- Consult the dealer or an experienced Radio/TV technician for help.

INDUSTRY CANADA REQUIREMENT:

This Class B digital apparatus meets all requirements of the Canadian Interference-Causing Equipment Regulations.

Cet appareil numérique de la classe B respecte toutes les exigences du Règlement sur le matériel brouilleur du Canada.

RECORD YOUR MODEL NUMBER (Now, while you can see it)

The model and serial number of your new DVD player are located on the bottom of the DVD player cabinet. For your future convenience, we suggest that you record these numbers here:

MODEL NO. _____

SERIAL NO. _____

IMPORTANT SAFETY INSTRUCTIONS

CAUTION: PLEASE READ AND OBSERVE ALL WARNINGS AND INSTRUCTIONS IN THIS OWNER'S MANUAL AND THOSE MARKED ON THE UNIT. RETAIN THIS BOOKLET FOR FUTURE REFERENCE.

This set has been designed and manufactured to assure personal safety. Improper use can result in electric shock or fire hazard. The safeguards incorporated in this unit will protect you if you observe the following procedures for installation, use and servicing.

This unit is fully transistorized and does not contain any parts that can be repaired by the user.

DO NOT REMOVE THE CABINET COVER, OR YOU MAY BE EXPOSED TO DANGEROUS VOLTAGE. REFER SERVICING TO QUALIFIED SERVICE PERSONNEL ONLY.

1. Read owner's manual

After unpacking this product, read the owner's manual carefully, and follow all the operating and other instructions.

2. Power Sources

This product should be operated only from the type of power source indicated on the marking label. If you are not sure of the type of power supply in your home, consult your product dealer or local power company. For products intended to operate from battery power, or other sources, refer to the operating instructions.

3. Grounding or Polarization

This product is equipped with a polarized alternating current line plug (a plug having one blade wider than the other). This plug will fit into the power outlet only one way. This is a safety feature. If you are unable to insert the plug fully into the outlet, try reversing the plug. If the plug should still fail to fit, contact your electrician to replace your obsolete outlet. Do not defeat the safety purpose of the polarized plug.

4. Ventilation

Slots and openings in the cabinet are provided for ventilation and to ensure reliable operation of the product and to protect it from overheating. These openings must not be blocked or covered. The openings should never be blocked by placing the product on a bed, sofa, rug or other similar surface. This product should not be placed in a built-in installation such as a bookcase or rack unless proper ventilation is provided or the manufacturer's instructions have been adhered to.

5. Heat

The product should be situated away from heat sources such as radiators, heat registers, stoves, or other products (including amplifiers) that produce heat.

6. Water and Moisture

Do not use this product near water—for example, near a bath tub, wash bowl, kitchen sink, or laundry tub; in a wet basement; or near a swimming pool and the like.

7. Cleaning

Unplug this product from the wall outlet before cleaning. Do not use liquid cleaners or aerosol cleaners. Use a damp cloth for cleaning.

8. Power-Cord Protection

Power-supply cords should be routed so that they are not likely to be walked on or pinched by items placed upon or against them, paying particular attention to cords at plugs, convenience receptacles, and the point where they exit from the product.

9. Overloading

Do not overload wall outlets, extension cords, or integral convenience receptacles as this can result in a risk of fire or electric shock.

IMPORTANT SAFETY PRECAUTIONS (Cont'd)

- 10. Lightning**
For added protection of this product during storms, or when it is left unattended and unused for long periods of time, unplug it from the wall outlet.
This will prevent damage to the product due to lightning and power-line surges.
- 11. Object and Liquid Entry**
Never push objects of any kind into this product through openings as they may touch dangerous voltage points or short-out parts that could result in a fire or electric shock. Never spill liquid of any kind on the product.
- 12. Attachments**
Do not use attachments not recommended by the product manufacturer as they may cause hazards.
- 13. Accessories**
Do not place this product on an unstable cart, stand, tripod, bracket, or table. The product may fall, causing serious injury to a child or adult, and serious damage to the product.
Use only with a cart, stand, tripod, bracket, or table recommended by the manufacturer, or sold with the product. Any mounting of the product should follow the manufacturer's instructions, and should use a mounting accessory recommended by the manufacturer. A product and cart combination should be moved with care. Quick stops, excessive force, and uneven surfaces may cause the product and cart combination to overturn.
- 14. Disc Tray**
Keep your fingers well clear of the disc tray as it is closing. It may cause serious personal injury.
- 15. Burden**
Do not place a heavy object on or step on the product. The object may fall, causing serious personal injury and serious damage to the product.
- 16. Connecting**
When you connect the product to other equipment, turn off the power and unplug all of the equipment from the wall outlet. Failure to do so may cause an electric shock and serious personal injury. Read the owner's manual of the other equipment carefully and follow the instructions when making any connections.
- 17. Sound Volume**
Reduce the volume to the minimum level before you turn on the product. Otherwise, sudden high volume sound may cause hearing or speaker damage.
- 18. Sound Distortion**
Do not allow the product to output distorted sound for a long-time. It may cause speaker overheating and fire.
- 19. Earphone**
When you use the earphone, keep the volume at a moderate level. If you use the earphone continuously with high volume sound, it may cause hearing damage.
- 20. Laser Beam**
Do not look into the opening of the disc tray or ventilation opening of the product to see the source of the laser beam. It may cause sight damage.



IMPORTANT SAFETY INSTRUCTIONS (Cont'd)

21. **Disc**
Do not use a cracked, deformed, or repaired disc. These discs are easily broken and may cause serious personal injury and product malfunction.
22. **Damage Requiring Service**
Unplug this product from the wall outlet and refer servicing to qualified service personnel under the following conditions:
 - a) When the power-supply cord or plug is damaged.
 - b) If liquid has been spilled, or objects have fallen into the product.
 - c) If the product has been exposed to rain or water.
 - d) If the product does not operate normally by following the operating instructions. Adjust only those controls that are covered by the operating instructions as an improper adjustment of other controls may result in damage and will often require extensive work by a qualified technician to restore the product to its normal operation.
 - e) If the product has been dropped or damaged in any way.
 - f) When the product exhibits a distinct change in performance-this indicates a need for service.
23. **Servicing**
Do not attempt to service this product yourself as opening or removing covers may expose you to dangerous voltage or other hazards. Refer all servicing to qualified service personnel.
24. **Replacement parts**
When replacement parts are required, be sure the service technician has used replacement parts specified by the manufacturer or have the same characteristics as the original part. Unauthorized substitutions may result in fire, electric shock, or other hazards.
25. **Safety Check**
Upon completion of any service or repairs to this product, ask the service technician to perform safety checks to determine that the product is in proper operating condition.

Table of Contents

Introductions

- ❑ Safety Precautions 2-3
- ❑ IMPORTANT SAFETY INSTRUCTIONS 4-6
- ❑ Table of Contents 7
- ❑ Precautions 8-9
- ❑ Notes on Discs 10
- ❑ Identification of Controls 11-16
 - Main Unit 11-12
 - Rear View 13
 - Display Window 14
 - Remote Control 15-16
- ❑ Power Connections 17-19
 - AC Adapter 17
 - Battery Pack 18-19

Basic Operations

- ❑ Playing a Disc 20-25
 - Basic Playback 20-22
 - Stopping Play 23
 - Resume Play 23
 - Screen Saver 23
 - Still Picture 24
 - Frame Advance 24
 - Skipping Chapters and Tracks Forward or Back 24
 - To Scan at Fast Forward or Fast Reverse Playback 25
 - Playing in Slow-Motion 25

Operation Using GUI Menu Icons

- ❑ General Information about GUI Menu Icons 26
- ❑ Detailed Description of each GUI Menu Icon 27-28

Advanced Operations

- ❑ Using a Title Menu 29
- ❑ Using a DVD Menu 29
- ❑ Changing Subtitle Language 30
- ❑ Changing Audio Soundtrack Language 31
- ❑ Viewing from another Angle 32
- ❑ Producing a 3D Surround Effect 33

- ❑ Repeat Play 34-35
- ❑ Storing Markers in Memory to be Viewed (Listened to) again 36
- ❑ Zoom Feature/Random Play 37
- ❑ Program Play 38
- ❑ Playback with MP3 39-40

Initial Settings

- ❑ Selection of Initial Settings 41
- ❑ Selecting Disc Language 42
- ❑ Selecting Rating Level and Password 43-44
- ❑ Selecting TV Aspect 45
- ❑ Selecting Menu Language 46
- ❑ Selecting Digital Audio Output 47-48
- ❑ Others 49
- ❑ Table of Languages and Their Code Numbers 50

Connections

- ❑ Connecting to a TV 51
- ❑ Connecting to an amplifier equipped with a Dolby Digital decoder 52
- ❑ Connecting to an amplifier equipped with a Dolby Pro Logic Surround 53
- ❑ Connecting to an amplifier equipped with a DTS decoder 54
- ❑ Connecting to an amplifier equipped with a digital audio input 55

Reference

- ❑ Disc Requirements 56
- ❑ Copyright Information 57
- ❑ Before Calling Service Personnel 58-60
- ❑ Specifications 61-62

Precautions

Notes on handling

- ❑ When shipping the DVD player, always use the original shipping carton and packing materials.
For maximum protection, repack the unit as it was originally packed at the factory.
- ❑ Do not use volatile liquids, such as insect spray, near the DVD player. Do not leave rubber or plastic products in contact with the DVD player for a long time. They will leave marks on the finish.
- ❑ The top and rear panels of the DVD player may become warm after a long period of use. This is normal and not a malfunction.
- ❑ When the DVD player is not in use, be sure to remove the disc and turn off the power.
- ❑ If you do not use the DVD player for a long period, the unit may not function properly in the future. Turn on and use the DVD player occasionally.

Notes on Locating

When you place this DVD player near a TV, Radio, or VCR, the playback picture may become poor and the sound may be distorted. In this case, move the DVD player away from the TV, Radio, or VCR.

Notes on Cleaning

Use a soft, dry cloth for cleaning.

- ❑ For stubborn dirt, soak the cloth in a weak detergent solution, wring well and wipe. Use a dry cloth to wipe it dry. Do not use any type of solvent, such as thinner and benzine, as they may damage the surface of the DVD player.
- ❑ If you use a chemical saturated cloth to clean the unit, follow that product's instructions.

Warning: Cleaning and adjustment of lenses and/or other components of playback mechanism should be performed by a qualified service technician.

To Obtain a Clear Picture

The DVD player is a high technology, precision device. If the optical pick-up lens and disc drive parts are dirty or worn down, the picture quality becomes poor. To obtain a clear picture, we recommend regular inspection and maintenance (cleaning or parts replacement) every 1,000 hours of use depending on the operating environment. For details, contact your nearest dealer.

Precautions (Cont'd)

Notes on Moisture Condensation

Moisture condensation damages the DVD player. Please read the following carefully.

Moisture condensation occurs, for example, when you pour a cold drink into a glass on a warm day. Drops of water form on the outside of the glass. In the same way, moisture may condense on the optical pick-up lens inside this unit, one of the most crucial internal parts of the DVD player.

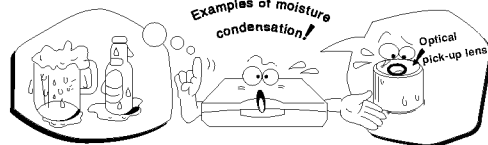

Moisture condensation occurs during the following cases.

- When you bring the DVD player directly from a cold place to a warm place.
- When you use the DVD player in a room where you just turned on the heater, or a place where the cold wind from the air conditioner directly hits the unit.
- In summer, when you use the DVD player in a hot and humid place just after you move the unit from an air conditioned room.
- When you use the DVD player in a humid place.

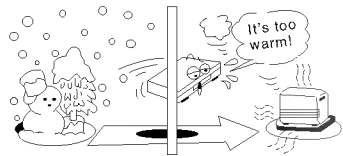

Do not use the DVD player when moisture condensation may occur. If you use the DVD player in such a situation, it may damage discs and internal parts. Remove the disc, connect the power cord of the DVD player to the wall outlet, turn on the DVD player and leave it "ON" for two or three hours. After two or three hours, the DVD player will have warmed up and evaporated any moisture. Keep the DVD player connected to the wall outlet and moisture condensation will seldom occur.

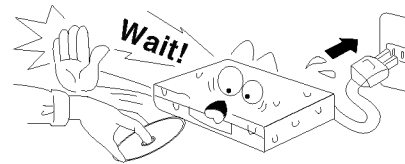

Notes on Discs

This section shows you how to handle, clean, and store discs.

On Handling Discs

- Do not touch the playback side of the disc.



- Do not attach paper or tape to discs.



On Cleaning Discs

- Fingerprints and dust on the disc cause picture and sound deterioration. Wipe the disc from the center outward with a soft cloth. Always keep the disc clean.
- If you cannot wipe off the dust with a soft cloth, wipe the disc lightly with a slightly moistened soft cloth and finish with a dry cloth.
- Do not use any type of solvents such as thinner, benzene, commercially available cleaners or anti-static spray for vinyl LPs. They may damage the disc.



On Storing Discs

- Do not store discs in a place subject to direct sunlight or near heat sources.
- Do not store discs in places subject to moisture and dust such as a bathroom or near a humidifier.
- Store discs vertically in a case. Stacking or placing objects on discs outside of their case may cause warping.

About This Owner's Manual

- This owner's manual explains the basic instructions of this DVD player.
- Some DVD video discs have functions that may not be explained in this owner's manual. Therefore, some instructions may differ from this owner's manual, and there may be extra instructions. In this case, follow the instructions displayed on the TV screen or package.
- “⊗” may appear on the TV screen during operation. This icon means the function explained in this owner's manual is not available on that specific DVD video disc.

Identification of Controls

Main Unit

** HOLD switch

- The hold function locks the buttons on the DVD player so that they will not work if accidentally touched.
- To enable, slide the HOLD switch on the left side of the DVD player to the HOLD position.
- To disable, slide the switch back to its original position.

* SKIP/SEARCH buttons

Press and hold button for about two seconds for search function.

*** AV In/Out switch

AV Out mode: While you are playing a disc.

AV In mode: While you are viewing video from other equipment.

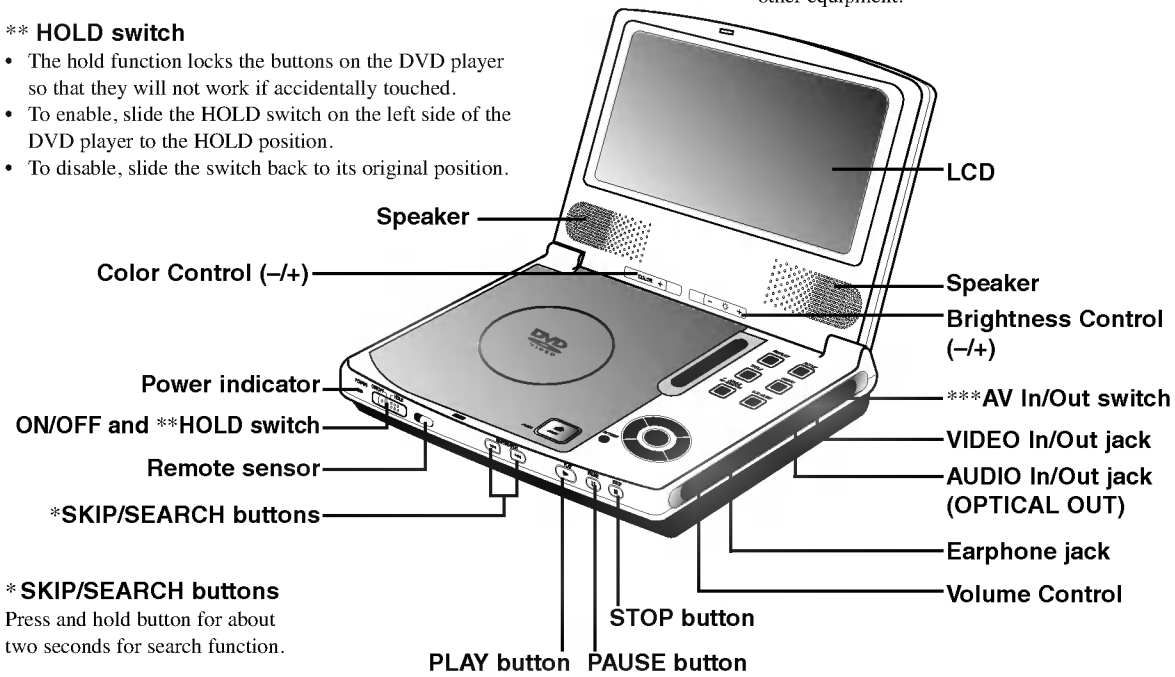

Identification of Controls (Cont.)

Main Unit

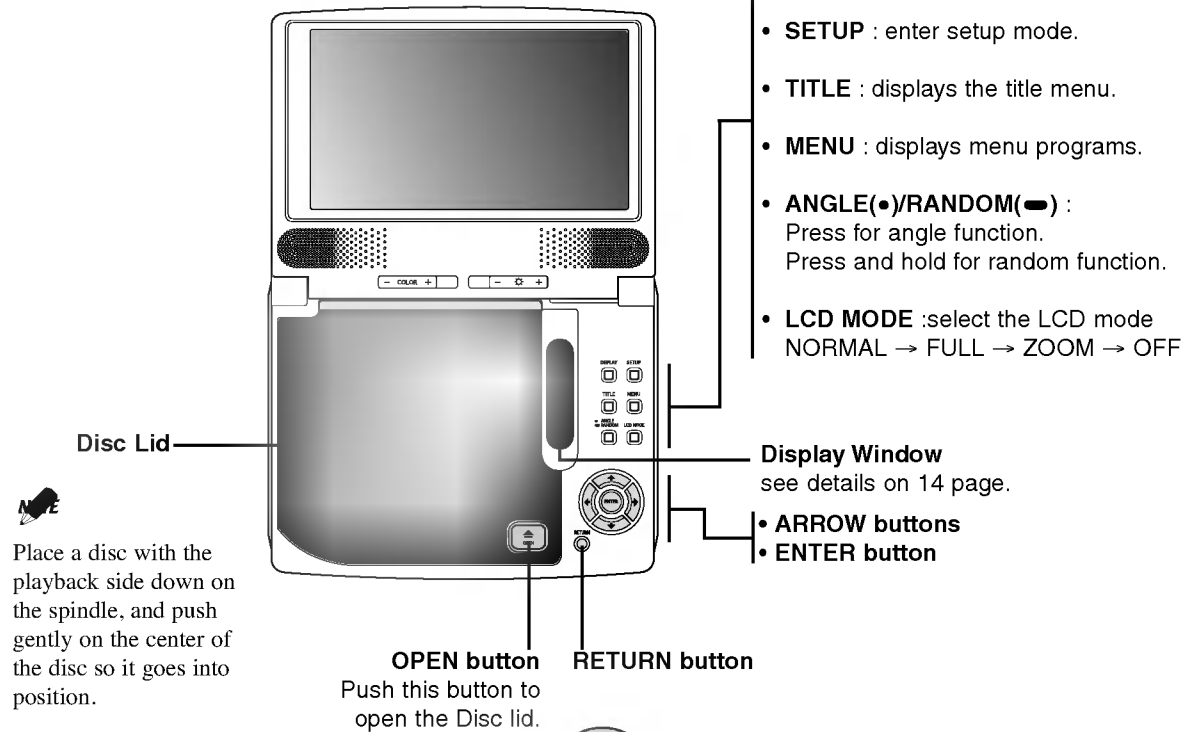

Identification of Controls (Cont.)

Rear View

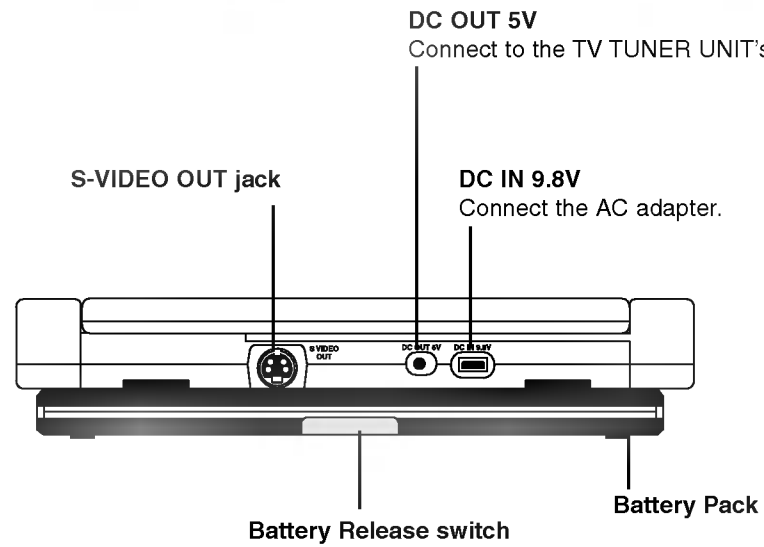

Introductions

Identification of Controls (Cont.)

Display Window

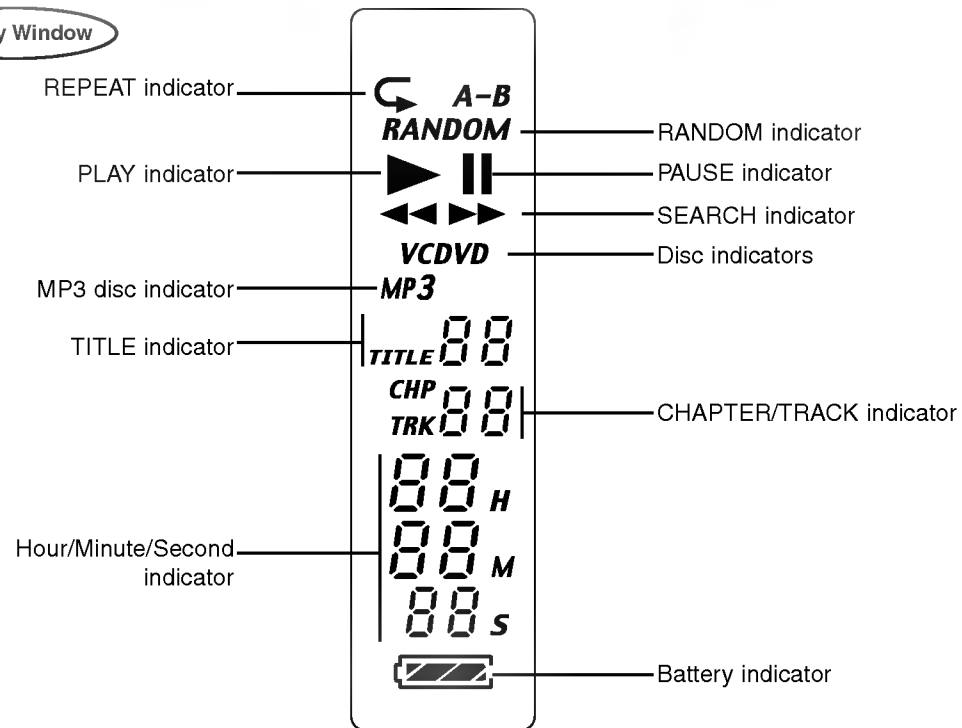

Identification of Controls (Cont.)

Remote Control

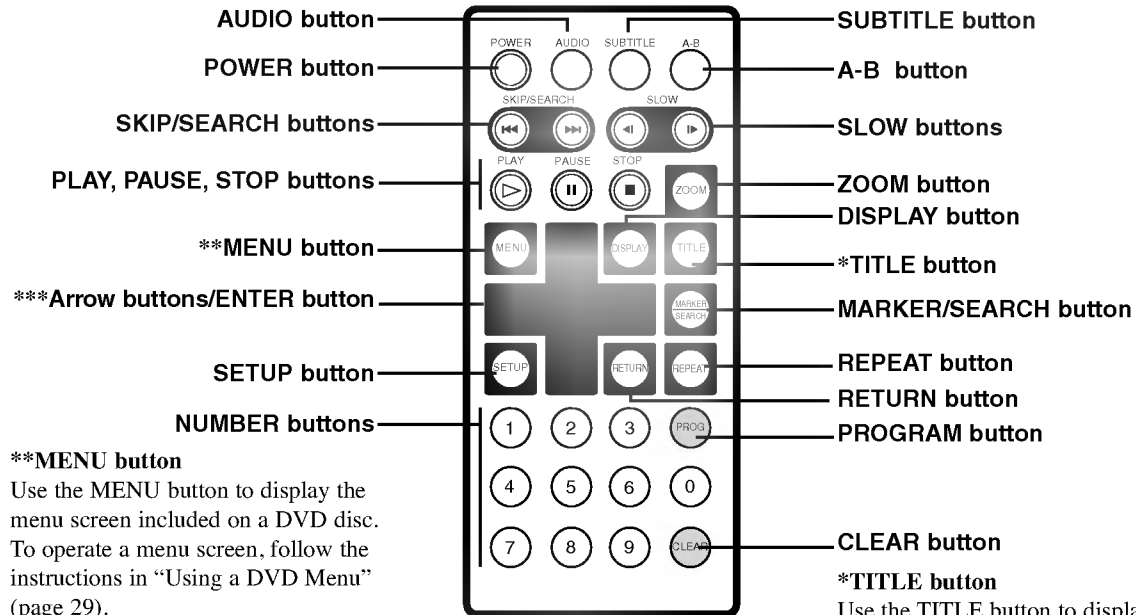

**MENU button

Use the MENU button to display the menu screen included on a DVD disc. To operate a menu screen, follow the instructions in "Using a DVD Menu" (page 29).

***Arrow buttons

(up, down, left, right) for use in highlighting a selection on a GUI menu screen, TITLE and MENU screen.

*TITLE button

Use the TITLE button to display the title screen included on DVD video discs. To operate a menu screen, follow the instructions in "Using a Title Menu" (page 29)

Identification of Controls (Cont.)

Insert the battery (Lithium battery)

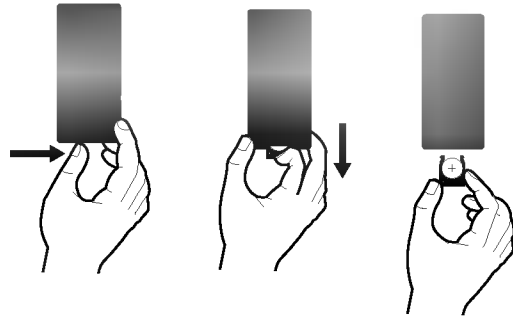

- Do not expose the remote control sensor to bright light.
- Do not place obstacles between the remote control sensor and the remote control.

■ Replacing the button-type battery

The battery normally lasts for about a year. Replace the battery if the remote control fails to operate the unit when used within the operation range.

Button-type battery (Lithium battery)

1. Pinch the battery holder clip together then pull the tab to remove the battery holder.
2. Insert the battery with the + facing in the same direction as the + on the battery holder.
3. Replace the battery holder with battery into the remote control unit making sure that it is fully inserted.

- Replace remote control unit battery with 3V micro lithium cells such as CR2025 or its equivalent.
- Dispose of battery safely in accordance with local laws. Do not dispose of in fire.

Warning : The battery used in this device may present a fire or chemical burn hazard if mistreated. Do not recharge, disassemble, incinerate, or heat above 100 °C (212 °F).

Replace the battery with Matsushita Elec. Ind. Co., Ltd. (Panasonic), part no. CR. 2025 only.

Use of another battery may present a risk of fire or explosion. Dispose of used batteries. Keep batteries away from children. Do not disassemble or dispose of in fire.

Power Connections

AC Adaptor

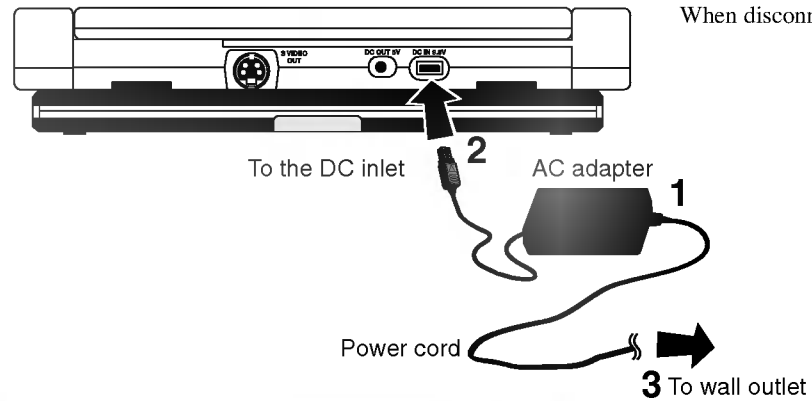

Follow steps 1 to 3 to connect.
When disconnecting, reverse the order.

AC adapter

- This AC adapter operates on 100-240V~ 1.5A 50-60Hz.
- TYPE NO. : AD-DP40
- Manufactured by POWERNET
- Contact an electrical parts distributor for assistance in selecting a suitable AC plug adapter or AC cord set.

Caution

- Do not connect the power plug to a power outlet other than that indicated on the label, as this can result in a risk of fire or electric shock.
- Do not connect or disconnect the power plug with wet hands. Doing so may cause electric shock.
- Do not use an AC adapter other than one specified, as it can cause a fire or damage to the player.

Power Connections

Battery Pack

- Charge the battery pack before using it for the first time.

■ Attaching the battery pack

1. Match the hooks of the battery pack into the holes on the rear of the player.
2. Press and slide the battery pack until the hooks click.

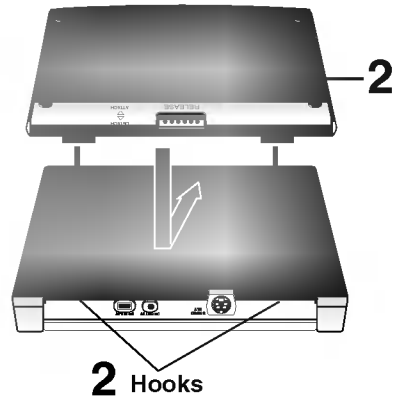

■ Detaching the battery pack

1. Press **RELEASE** switch
2. Slide the battery pack until the hooks click.

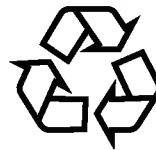
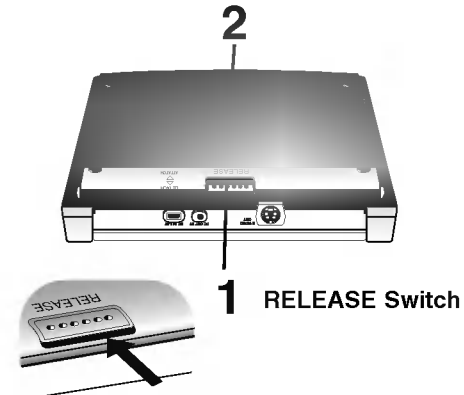

ATTENTION

The product that you have purchased contains a rechargeable battery. The battery is recyclable. At the end of its useful life, under various state and local laws, it may be illegal to dispose of this battery into the municipal waste stream. Check with your local solid waste/officials for details in your area for recycling options or proper disposal.

Power Connections

■ Charging the battery pack

1. Attach the battery pack to the player.
2. Connect the supplied AC adapter and the power cord to the player. Or,.
Connect the AC adapter cord to the battery pack.
3. During recharging, charge indicator is red. If recharging is complete, charge indicator changes to green color.

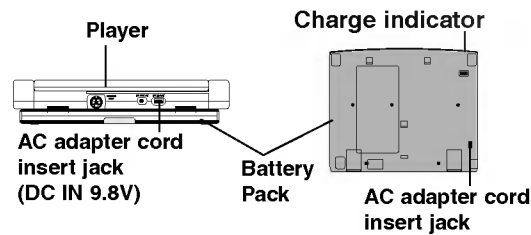

CAUTION

Take the following precautions to avoid liquid leakage, overheating, etc.

- Do not use any unauthorized parts.
- Use the authorized AC adapter when recharging battery.
- Do not expose to high temperature above 60°C (140°F).
- Do not attempt to dismantle or modify the unit.
- Excessive impact may cause the unit to malfunction.
- Do not incinerate.
- Do not disassemble; dispose of properly.

■ Recharging and play times

Recharging		Play time	
without player	with player	LCD On	LCD Off
Approx. 2.5 hour	Approx. 5 hours	Approx. 4 hours*	Approx. 7 hours

* When Brightness control is set to “-”.

- Times shown above depend on operating conditions.

■ Confirm the battery charge on the unit's display window

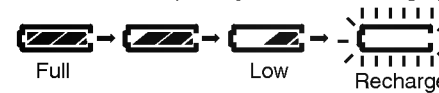

- If using the AC adapter, battery display does not appear.

■ If play time dramatically reduces after recharging

The battery pack has reached the end of its service life (it can be recharged about 300 times).

■ If the unit is not to be used for a long time

- Detach the battery pack. (Even if the unit is off, it still uses some power. This can lead to over discharging of the battery and malfunction.)
- Recharge the battery pack when you are ready to use it again.

■ Battery Pack

- TYPE NO. : DP-BT40
- Manufactured by Smart Mobile Communication

Playing a Disc



Basic Playback

- Prepare the power supply.

1. Open the outer cover and slide the ON/OFF switch to the left to turn unit on.

Power indicator lights and then the indicator will disappear after 5 seconds.

2. Press OPEN to open the disc lid and insert a disc with the side you want to play label up. Close the disc lid by hand.

- If the disc is placed in upside down (and it is a single-sided disc), "NO DISC" or "DISC ERROR" appears on the TV screen.
- If you insert an audio CD, the CD indicator lights up in the display window. The title number does not appear.
- After playing back all of the chapters in the title, the DVD player automatically stops and returns to the menu screen.

3. Press PLAY to start play.

4. Adjust the volume.



- Place a disc with the playback side down on the spindle, and push gently on the center of the disc so it goes into position.
- Confirm LCD MODE position by pressing LCD MODE button.
- If no picture on the LCD, check that the AV in/Out switch is set to AV Out mode.

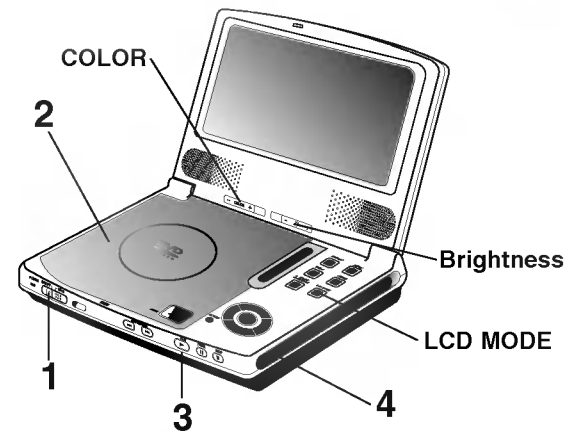

■ Adjusting color intensity

Use the COLOR slide switch $-/+$ to adjust the color shade.

- ; black and white
- + ; color

- Power consumption increases with the level of color.

■ Adjusting the brightness

Use the BRIGHTNESS slide switch $-/+$ to adjust the brightness.

- ; dark
- + ; light

Playing a Disc



■ Changing the size of the picture

Use the LCD MODE button to change the picture mode. The mode is shown on the unit's display window as follows.

NORMAL → FULL → ZOOM → OFF



■ The picture mode and size

The picture shown on the LCD depends on the display mode and the size recorded on the disc.

Mode Software	NORMAL	FULL	ZOOM	OFF
Wide-screen	Full screen 	Full screen 	Top and bottom edges are cut off. 	OFF
Regular (4:3)	Screen with blackbands on the right and left 	The normal mode screen is horizontally enlarged. 	Top and bottom edges of the full mode screen are cut off. 	OFF
Regular (4:3), Letterbox	The picture is surrounded by a black frame. 	The normal mode screen is horizontally enlarged. 	Full screen 	OFF



- If you are not using the LCD on this unit, select OFF to conserve power.
- The LCD is turned off if you close the unit.
- Horizontal lines may appear in the picture when the mode is switched to ZOOM, but this is not an indication of a malfunction.

Playing a Disc



■ When a menu screen appears on the TV screen.

In case of interactive DVDs with control, a menu screen appears on the TV screen.

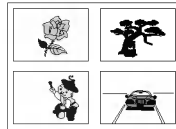

Example of interactive
DVD On-Screen Menu

Press ▲/▼/◀/▶ and press ENTER, or press the numeric button(s), to select the desired item.



OR

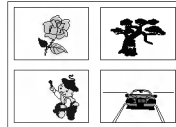

Play of the selected item now begins.

- For further information, also refer to the jacket or case of the disc you are playing.

After operation

When the unit is not in use, remove the disc and press POWER to turn off the DVD player.

Video CD

This contains recordings of pictures and sound whose quality is on a par with that of video tape. This player also supports Video CDs with playback control (Version 2.0).

What is playback control (PBC)?

If a Video CD has “playback control” written on its disc or jacket, it means that particular scenes or information can be selected for viewing interactively with the TV monitor using the menu screen.



- When “⊗” appears on the TV screen while a button is pressed, it means that this function is not available on the disc you are playing.
- Depending on the DVD disc, some operations may be different or restricted. Refer to the jacket or case of the disc you are playing.

Playing a Disc

■ Stopping Play

Press STOP during playback.

■ Resume Play

When play is stopped, the unit records the point where STOP was pressed (RESUME function).

Press PLAY and play will resume from this point.



- This operation works only with discs for which the elapsed playing time appears in the display window during stop.
- Resume function will be cleared when the STOP is pressed in the STOP mode.
- The Resume function may not be available on some DVD discs or Video CDs (version 2.0).

■ Screen Saver

The screen saver is useful to prevent your display from becoming damaged.

The screen saver picture appears when you leave the DVD player in stop mode for about 5 minutes.

Automatic power off function

After the Screen Saver has been engaged for about 5 minutes, the DVD player will automatically turn itself off.



Screen Saver

Playing a Disc

■ Still picture

Press **PAUSE** during playback.

- DVD/Video CD
The player will be placed in the still picture mode.
- CD
The player will be placed in the pause mode.

■ Frame Advance (DVD and Video CD only)

Press **PAUSE** during still playback.

(Each time you press **PAUSE**, the picture advances one frame)

To resume normal playback, press PLAY.

■ Skipping Chapters and Tracks Forward or Back

Skipping forward

Press **SKIP ►►** during playback.

A chapter (DVD) or a track (CD/Video CD) is skipped each time the button is pressed.

Skipping back

Press **SKIP ◄◄** during playback.

- When the button is pressed once midway through a chapter/track, the player returns to the start of that chapter/track. When it is pressed again, a chapter/track is skipped each time the button is pressed.

For your reference:

- When **◄◄ SKIP ►►** is pressed during menu play of video CDs equipped with PBC (Version 2.0), a menu screen may sometimes be recalled.

Playing a Disc



■ To Scan at Fast Forward or Fast Reverse Playback

Press and hold **SKIP** or button for about two seconds during playback.

[TV screen]

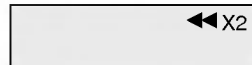

- The speed of advance (reverse) is relatively slow at first. When the button is pressed again, the speed becomes faster. (Each time the button is pressed, the speed increases up to 4 steps (DVD) or 3 steps (Video CD/CD).)
- The speed will be retained even after the button is released.

To return to normal playback, press **PLAY**.



- The DVD player does not play back sound during the high speed reverse and forward playback of DVD video discs.
However, the DVD player plays back sound during fast forward or fast reverse playback of audio CDs.

■ Playing in Slow-Motion (DVD and Video CD only)

Press **SLOW** or during playback.
The playback speed becomes 1/16 of the normal speed.

[TV screen]



- The speed of slow-motion is slow at first. When the button is pressed again, the speed becomes faster. (Each time the button is pressed, the speed increase up to 4 steps.)
- The speed will be retained even after the button is released.

To return to normal playback, press **PLAY**.



- The sound is muted during slow-motion playback.
- Subtitles do not appear on the screen during slow motion playback.
- The **SLOW** buttons do not work with Audio CDs.
- The reverse slow does not work with Video CD.

General information about GUI Menu



This unit features GUI Menu Icons showing disc information (title/chapter/track number, elapsed playing time, audio/subtitle language, angle, and sound) and player information (repeat play, play mode, marker, etc.). Some icons only show the indicated information. Other icons allow the settings to be changed.

* GUI: Graphic User Interface

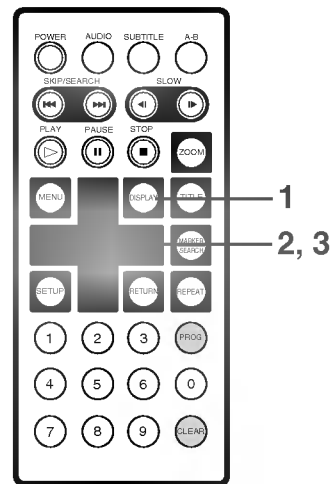

Common procedures

1. Press **DISPLAY** during playback.

Title function can be accessed from the stop mode.

2. Press **▲/▼** to select the desired item.

The current selected item is indicated by a yellow frame on its GUI menu icons.

3. Press **◀/▶** to select the desired setting.

- When numbers are displayed (e.g. title number), the numeric buttons can also be used for setting instead of **◀/▶**.
- For some functions, the setting will be registered immediately; for others, ENTER must be pressed.

To clear the GUI Menu Icons, press **DISPLAY** again.

Examples of GUI Menu Icons.

(The screens may differ depending on the disc contents.)

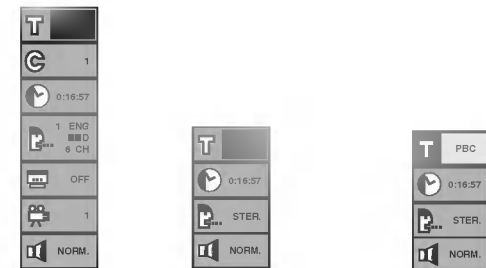

(DVD GUI) (CD/Video CD GUI) (Video CD (Version 2.0))

Detailed Description of each



You can view information about a disc and its operational status on the TV screen.

Press DISPLAY during playback. [TV screen]
DVD GUI

FUNCTION
(Press ▲/▼ to select desired item)

SELECTION METHOD



To show the current title number **and to jump to the desired title number**

◀▶, or Numeric ENTER

To show the current chapter number **and to jump to the desired chapter number**

◀▶, or Numeric ENTER SKIP

To show the elapsed time **and directly select scenes by the desired time.**

Numeric ENTER

To show the current audio soundtrack language, encoding method, channel number **and to change the settings.**

◀▶, AUDIO

To show the current subtitle language **and to change the setting.**

◀▶, SUBTITLE

To show the current angle number **and to change the angle.**

◀▶, ANGLE

To show the current sound (NORMAL or 3D SURROUND) **and to change the setting.**



◀▶

Operation Using GUI Menu Icons

Detailed Description of each GUI Menu Item (cont'd)



Press DISPLAY during playback. [TV screen] CD/Video CD GUI

	FUNCTION (Press ▲/▼ to select desired item)	SELECTION METHOD
 0:16:57	To show the current track number and to jump to the desired track number	◀▶, or Numeric ENTER SKIP
 STER.	To show the elapsed time. (Display only)	—
 NORM.	To show the current audio (STEREO, LEFT, RIGHT) and to select the desired audio channel.	◀▶, AUDIO
	To show the current sound (NORMAL or 3D SURROUND) and to change the setting.	◀▶



- Some DVD discs may not provide all of the above GUI menu icons.

Using a Title/DVD Menu



Using a Title Menu

Some movie discs may contain two or more titles. If the disc has a title menu recorded on it, the TITLE button can be used to select the movie title. (The details of operation differ depending on the disc used.)

- Selecting a title may not be possible on certain DVD discs.

1. Press TITLE.

A list of the titles on the disc is displayed.

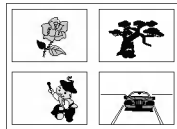

Press TITLE again to resume play from the scene when TITLE was first pressed.

- Resume play may not be possible on certain discs.
- #### 2. Press ▲/▼/◀/▶ and press ENTER or PLAY, or press the numeric button(s), to select desired title.

The selected title now starts playing.

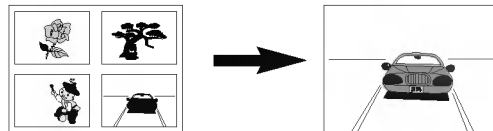

Using a DVD Menu

Some DVDs have unique menu structures called DVD menus. For example, DVDs programmed with complex contents provide guide menus, and those recorded with various languages provide menus for audio and subtitle language. Although the DVD menu's contents and operation differ from disc to disc, the following explains the basic operation when this feature is used.

1. Press MENU during play.

The DVD menu available on the disc is now displayed.

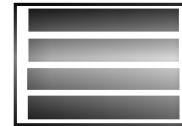

Pressing MENU again resumes play from the scene when MENU was first pressed.

- Resume play may not be possible on certain discs.

2. Press ▲/▼/◀/▶ and press ENTER, or press the numeric button(s), to select desired item.

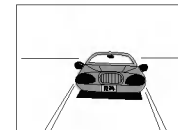

The selected item is now executed.

Changing Subtitle Language



It is possible to change the subtitle language to a different language from the one selected at the initial settings. (See page 42 for further info.)

This operation works only with discs on which multiple subtitle languages are recorded.

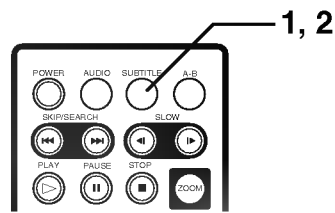

- In some cases, the subtitle language is not changed to the selected one immediately.
- When a disc supporting the closed caption is played, the subtitle and the closed caption may overlap each other on the TV screen. In this case, turn the subtitle off.
- When the desired language is not selected even after pressing the button several times, it means that the language is not available on the disc.
- When the power is turned on or the disc is removed, subtitles appear in the language selected at the initial settings. If this language is not recorded on the disc, the disc's priority language appears.

1. Press SUBTITLE during playback.

When no subtitles are recorded, "OFF" will be displayed instead of the language number.



2. Press SUBTITLE repeatedly until the desired language is selected.

Number of the subtitle language being played back is shown.



To eliminate the On Screen Subtitles.

Press SUBTITLE repeatedly to select OFF at step 2.

Changing Audio Soundtrack



It is possible to change the audio soundtrack language (or encoding method, channel number) to a different language from the one selected at the initial settings in case of DVD disc. (See page 42 for further info.) This operation works only with discs on which multiple audio soundtrack languages are recorded.

And it is possible to change the audio channel in case of audio CD.

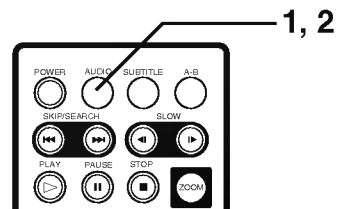

- When the desired language is not selected even after pressing the button several times, it means that the language is not available on the disc.
- When the power is turned on or the disc is removed, the language heard is the one selected at the initial settings. If this language is not recorded on the disc, only the available language on the disc will be heard.
- Some discs may not respond to Audio feature.

• DVD

1. Press AUDIO during play.

Number of the audio soundtrack language being played back.



2. Press AUDIO repeatedly until the desired language (or encoding method, channel number) is selected.



• CD/Video CD

1. Press AUDIO during play.



2. Press AUDIO repeatedly until the desired sound is selected.



Viewing from another Angle



Some DVDs may contain scenes which have been shot simultaneously from a number of different angles. For these discs, the same scene can be viewed from each of these different angles using the ANGLE button. (The recorded angles differ depending on the disc used.)

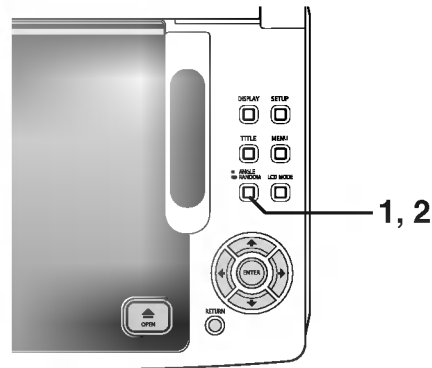
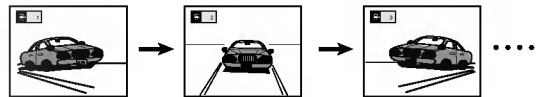

1. Press ANGLE during playback.

Number of angle
being played back.



2. Press ANGLE repeatedly until the desired angle is selected.



For your reference

- The ANGLE indicator will blink in the display window at scenes recorded at different angles to indicate that angle switching is possible.
- The angle number can be programmed beforehand; the angle will be switched to the selected number when the ANGLE indicator blinks.



- This function only works for discs having scenes recorded at different angles.

Product a 3D Surround Effect



This unit can produce a 3D Surround effect, using 3D Surround Sound technology, which simulates multi-channel audio playback from two conventional stereo speakers instead of the five or more speakers normally required to listen to multi-channel audio from a home theater. This feature works with DVD discs encoded with Dolby Pro Logic and Dolby Digital audio tracks.

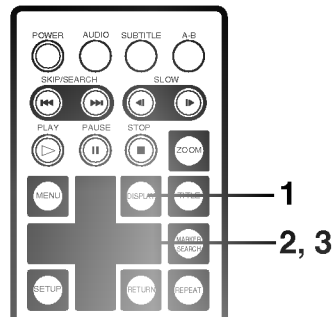

1. Press **DISPLAY** during playback.

2. Press **▲/▼** to select **SOUND** item.



3. Press **◀/▶** repeatedly until the desired sound is selected.

Each time this button is pressed, the TV screen display changes.



- This 3D Surround effect may not be available on some DVD discs, such as those recorded with a mono audio soundtrack.
- Turn off the TV surround sound and other surround effects when using this 3D surround effect.
- For best 3D Surround effect using only two speakers, it is recommended that the two speakers be positioned approximately 8' to 10' apart, and that the listening position be 8' to 10' away from the speakers.

Repeat Play



Repeating viewing (listening)

Press **REPEAT** during playback.

Each time this button is pressed, the TV screen changes as shown below and the disc will repeat a chapter or title (DVD) or a track (CD/Video CD).

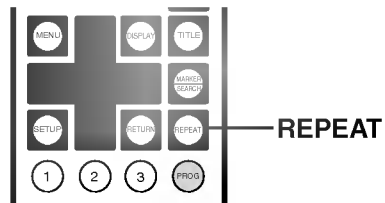

• DVD

Cancel repeat mode (normal play)

Repeat of chapter being played

Repeat of title being played

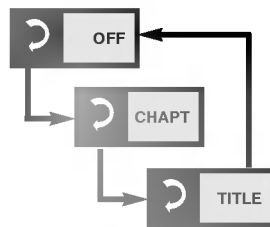

• CD/Video CD

Cancel repeat mode (normal play)

Repeat of track being played

Repeat of entire disc contents

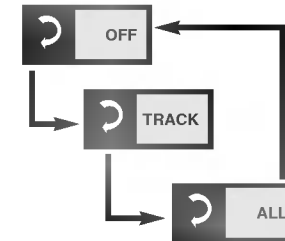

To enjoy program repeat play (CD/Video CD)

If REPEAT is pressed during program play, repeat play is operated as below.

Cancel repeat mode (Program play)

Repeat of the current programmed track

Repeat of all programs

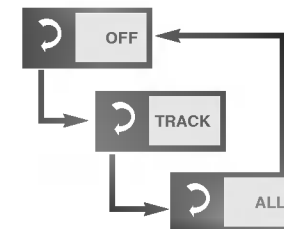

To return to normal play

Press REPEAT several times until "OFF" is displayed.

Repeat Play (Cont'd)



Repeating sections between two specific points (A-B repeat)

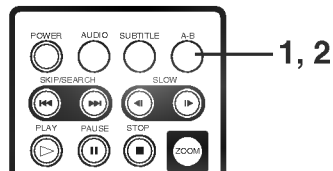

NOTES

- Repeat play works only with discs for which the elapsed playing time appears in the display window during playback.
- Repeat play may not work correctly with some DVDs and some Video CDs.
- A-B repeat play works only within a title DVD or a track CD/Video CD.
- Some subtitles recorded around point A or B may fail to appear (DVD).

1. Press A-B during playback at the point where repeat play is to start (A).



- You can select "OFF" at this step by pressing CLEAR.

2. Press A-B during playback at the point where repeat play is to be concluded (B).



Repeat play of the selection between points A and B starts.

To return to normal playback

Press A-B once "OFF" is displayed.



Storing Markers in Memory to be Mem... (Listened to) again



Storing a MARKER in the DVD memory is similar to marking your page in a book. It allows you to quickly return to any point on the disc.

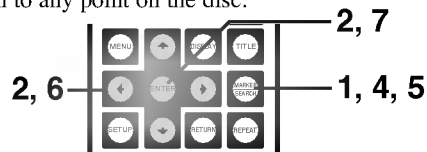

Storing a marker in the memory

1. Press MARKER/SEARCH during play.

The MARKER SEARCH menu appears on the TV.



2. During playback, press ENTER when playback reaches the spot that you want to memorize.

- The Marker number appears.
- Do this within 10 seconds while the MARKER SEARCH menu appears.
- To enter additional Marker points, press ◀▶ until another empty point on the MARKER SEARCH menu is highlighted, then press ENTER when playback reaches the point at which you want the next Marker.

3. Repeat step 2 to enter up to nine Marker points on a disc.

4. To remove the MARKER SEARCH menu, press MARKER/SEARCH.

Recalling/Clearing a marker

5. Press MARKER/SEARCH during playback.

The MARKER SEARCH menu will appear on the screen.



6. Press ◀▶ to select the marker to be recalled/cleared.

7. Press ENTER to recall a marker.

Press CLEAR to clear a marker.

Play resumes from the point corresponding to the selected marker, or the selected marker is cleared.



- These operations work only with discs for which the elapsed playing time appears in the display window during playback or stop.
- Some subtitles recorded around the marker may fail to appear (DVD).
- All the markers are cleared when the power is turned off or the disc is removed.
- The marker is not stored when the DVD or title menu is displayed on the TV screen.

Zoom Feature/Random Play



Zoom feature (DVD and Video CD only)

The Zoom function allows you to enlarge the video image and to move through the enlarged image.

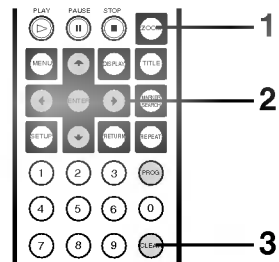

1. Press ZOOM during playback or still playback to activate the Zoom function.

If you further press ZOOM repeatedly, the magnification level increases (6 steps).

2. Press ▲/▼/◀/▶ buttons to move through the zoomed picture.

3. Press CLEAR to resume normal playback.



- Some discs may not respond to the Zoom feature.
- Zoom does not work on subtitles or menus included on DVD video discs.

Random play (Karaoke DVD, Video CD or CD)

Note: This function only works with karaoke DVD, Audio CD and Video CD. Random does not work with DVD movie discs.

You can playback titles or tracks in random order. (Random playback)

The DVD player automatically selects the titles on a DVD video karaoke disc only and plays them back randomly.

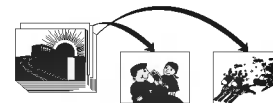

1. Press and hold RANDOM on the main unit for about two seconds during normal playback or stop mode.

The DVD player automatically starts random playback and the RANDOM indicator in the display window appears.

2. To resume normal playback, press and hold RANDOM on the main unit for about two seconds until the RANDOM indicator in the display window disappears.



- Random playback may not be possible on certain discs.
- If you press the SKIP ◀◀ or ▶▶ button during random playback, the DVD player goes to another track randomly and starts playback.

Program Play

The player plays the tracks on the disc in the order you specify.

Note: Program play function is possible only with audio CDs. It does not work with DVD movie discs and Video CDs (Version 2.0).

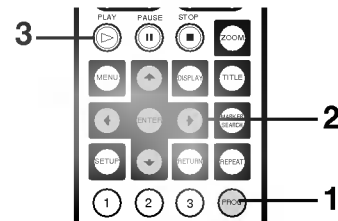

1. Press PROGRAM on the stop mode.

The program playback menu screen appears on the TV screen.

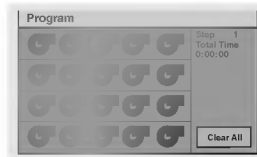

- To exit the menu screen, press PROGRAM or RETURN.

2. Press ▲/▼/◀/▶ and press the numeric button(s), to select the desired track number.

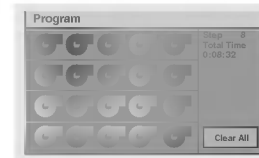

- Repeat step 2 to select another track.
- Up to 20 tracks can be programmed.

3. Press PLAY to exit the screen.

The selected track is stored in the memory and play now begins in the programmed sequence.

After playback of all tracks programmed

Play is stopped.

Clearing the program

• To clear the programmed tracks one by one

Press ▲/▼/◀/▶ to select the unwanted number and then press CLEAR.

• To clear all the programmed tracks

Press ▲/▼/◀/▶ to select "Clear All" and then press ENTER. Press PROGRAM or RETURN to exit the menu screen. (The programs are also cleared when the power is turned off or the disc is removed.)

1. Load an MP3 disc.

The MP3 menu is displayed and playback starts automatically.

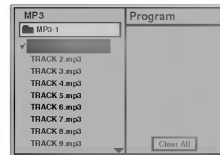

2. Press ▲/▼ button to select the desired MP3 file and then press PLAY or ENTER to start playback of the file.

For your reference

- Press SKIP▶▶ or SKIP◀◀ to play the next file or previous file during playback.
- Press DISPLAY to move to the next page.
- Press PAUSE to enter the pause mode, press PLAY or PAUSE again to return to normal playback.
- Press STOP to stop the playback.

To play an MP3 file repeatedly

- If you press REPEAT once during play, the current MP3 file will play repeatedly.
- If you press REPEAT twice during play, all MP3 files on the disc will play repeatedly.
- If you press REPEAT three times, repeat play will be cancelled.



- The file name is only displayed in English.
- If there is an impossible code to display, it will be displayed underlined () instead of English.
- This unit can play up to 200 files per disc.
- Disc format is compatible with ISO9660 only.
- If you record MP3 files using the software which cannot create a FILE SYSTEM, for example "Direct-CD" etc., it is impossible to playback MP3 files. We therefore recommend that you use "Easy-CD Creator", which creates an ISO9660 file system.
- If there are already data files which are not MP3 files on the CD-R disc, please, do not use that disc; use a new one instead. However, if the disc is a CD-RW disc, this does not apply.

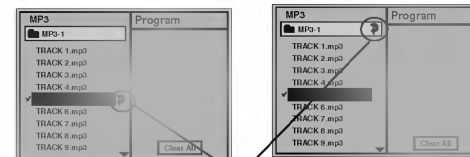



REPEAT symbol

To program play an MP3 file

1. Load an MP3 disc.

The MP3 menu is displayed.

2. Press PROGRAM to enter the Program Editing mode in the stop mode.

- The  mark appears to the right of the word Program on the right side of MP3 menu.
- Press RETURN to exit the Program Editing mode, the  mark will disappear.

3. Press ▲/▼ to select the desired MP3 file and then press ENTER to add the MP3 file to the program list.

- Repeat step 3 to select another track.
- Up to 60 files can be programmed.



4. Press PLAY to play.

Playback now begins in the programmed sequence.

If you want to enter the main menu, press ◀ button.

After playback of all tracks programmed

Play is stopped.

Clearing the program

• To clear the programs one by one

In the Program Editing mode, press ▲/▼/◀/▶ to select the unwanted MP3 file on the program list and then press CLEAR.

• To clear all the programs

In the Program Editing mode, press ▲/▼/◀/▶ to select the “Clear All” and press ENTER.

To play an MP3 file repeatedly

- If you press REPEAT button once during play, the current MP3 file will play repeatedly.
- If you press REPEAT button twice during play, all MP3 files on the program list will play repeatedly.
- If you press REPEAT button three times, repeat play will be cancelled.



REPEAT symbol

Selection of Initial Settings



Once the initial settings have been completed, the player can always be operated under the same conditions (especially with DVD discs).

The settings will be retained in the memory until they are changed, even if the power is switched off.

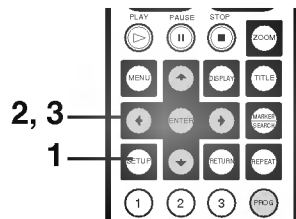

Selection of initial settings

1. Press **SETUP** in the stop or playback mode.

The **SETUP** menu is displayed.



2. Press **▲/▼** to select the desired item.

The screen will show the current setting for the selected item, and the alternate setting(s).

- Disc Audio (see page 42.)
- Disc Subtitle (see page 42.)
- Disc Menu (see page 42.)
- Rating (see page 43.)
- Password (see page 44.)
- TV Aspect (see page 45.)
- Menu Language (see page 46.)
- Digital Audio Output (see pages 47-48.)
- Others (see page 49.)

3. Press **▶** and then **▲/▼** to select the desired setting and press **ENTER**.

- Some items require additional steps. (See the respective page.)

When the alternate setting is selected the screen returns to the Initial Settings display.

To exit **SETUP** menu

Press **SETUP**, **RETURN** or **PLAY**.

Selecting Disc Language



This is to select the audio soundtrack language, subtitle language and the language used in title menus or DVD menus which will always be used for every disc to be played back.

When you play back a DVD video disc, the DVD player automatically displays the pre-selected subtitle language if it is included on the disc.

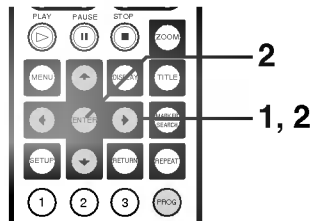

1. At the **SETUP** menu screen, press ▲/▼ to select “Disc Audio” and press ►.



2. Press ▲/▼ to select the desired language and then press **ENTER**.



Original : The original language of each disc will be selected.

English : English will be selected.

Other : Another language can be selected. You can input a 4-digit language code. (Refer to the language codes on page 50. Press CLEAR if an incorrect language code is entered.)

The “Disc Subtitle” and “Disc Menu” are selected by the same method.



- If the language selected is not available on the disc, the original language designated by each disc will be selected.

Selecting Rating Level and Password



This is to prohibit the playing of specified DVDs which are unsuitable for children.

- Some DVD discs contain a restriction level which enables parents to remove scenes or prevent playback of discs by children. DVD players are equipped with a password designed to prevent children from changing the level.

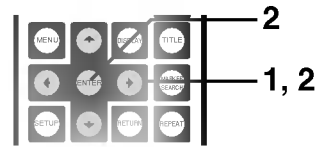

Selecting rating level (DVD only)

1. At the **SETUP** menu screen, press **▲/▼** to select **“Rating”** and press **▶**.



2. Press **▲/▼** to select the desired level and press **ENTER**.



You cannot play DVD video discs rated higher than the level you selected unless you cancel the parental lock function.

For example, when you select level 7, discs rated higher than level 7 are blocked and cannot be played.

The parent lock level is equivalent to the following USA movie ratings.

Level 7: NC-17	Level 6: R	Level 4: PG 13
Level 3: PG	Level 1: G	

- Some titles do not match with the rating level described as above.

If you change the level and enter a password, playback of all DVDs with ratings higher than your selection will be blocked, unless the correct password is entered again. For example: if you change the level to “5”, the DVD player will not play discs with ratings of “6”, “7” or “8” unless the correct password is entered on the remote control.

Selecting Rating Level and Password (DVD)



Setting your password (DVD only)

If you change the rating level to “7” or lower, you must enter a 4-digit “password” to prevent playback of discs with higher ratings.

1. At the **SETUP** menu screen, press **▼** to select “**Password**” and press **▶**.



2. **Input a 4-digit password and press ENTER.**

Example : 1234

Do not forget your password.

3. **Input the 4-digit password again and press ENTER to verify.**

Setting is finished.

- The rating is locked. Any disc whose rating is higher than the setting, cannot be played back unless the correct password is entered.

To change/clear memorized password

1. At the **SETUP** menu screen, press **▼** to select “**Password**” and press **▶**.
2. **Input your password and press ENTER.**



3. To change or clear your password, press **▲/▼** to select the “**Change**” or “**Clear**” and press **ENTER**.

To change the rating level/password, follow the steps on page 43-44 again.

To clear your 4-digit password

If you forget your password, to clear the current password, follow the procedure below.

- 1 **Press SETUP.**
The **SETUP** menu is displayed.
- 2 **Enter 6-digit number “210499” by pressing number buttons.**
The 4-digit password is cleared. “PC” appears on the display window.
- 3 **Enter a new password.**
Refer to “Setting your password” section to the left.

Selecting TV Aspect



Select the appropriate screen type according to your TV set; conventional size screen (4:3) or wide-screen (16:9).

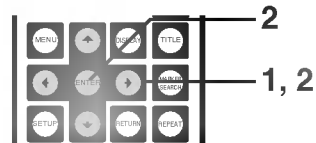

1. At the **SETUP** menu screen, press **▲/▼** to select “TV Aspect” and press **▶**.



2. Press **▲/▼** to select the desired Aspect and press **ENTER**.

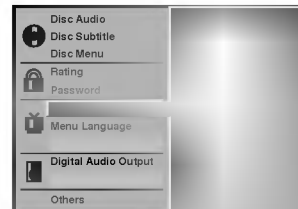

4:3 Letterbox : The video material not formatted in the Pan & Scan style is played back in the letterbox style (black bands appear at top and bottom of screen).

4:3 Panscan : Select when a conventional TV set is connected. The video material formatted in the Pan & Scan style is played back in that style (the left and right edges are cut off).

16:9 Wide : Select when a wide-screen TV set is connected. Played in “FULL” size. (Setting the wide-screen TV to “FULL” mode is also necessary.)

* Each screen shows an example when the video material for a wide-screen is played.
(This setting does not affect the video material for conventional size.)

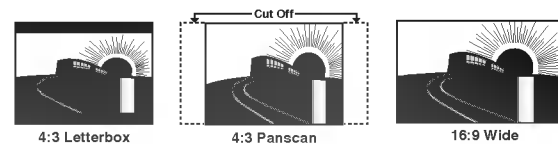

Initial Settings

Selecting Menu Language



Selects language for SETUP menus and displays on the TV.

1. At the SETUP menu screen, press ▲/▼ to select “Menu Language” and press ►.

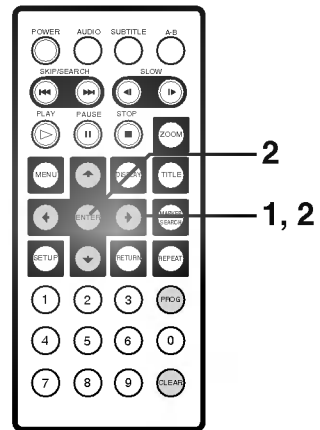

2. Press ▲/▼ to select the desired Language and press ENTER.



Selecting Digital Audio Output



Each DVD disc has a variety of audio output options. Set the player's Digital Audio Output according to the type of audio system you use.

1. At the **SETUP** menu screen, press **▲/▼** to select "Digital Audio Output" and press **▶**.



2. Press **▲/▼** to select the desired output and press **ENTER**.

You can select Digital Audio Output or Sampling Frequency item by pressing **ENTER**.

■ Digital Audio Output

DOLBY DIGITAL/PCM: Select "DOLBY DIGITAL/PCM" if an active digital output is supplied to a Dolby Digital decoder, (or an amplifier or other equipment with Dolby Digital decoder).

Stream/PCM: Select "Stream/PCM" if an active digital output is supplied to an amplifier or other equipment with DTS decoder, Dolby Digital decoder and MPEG decoder.

PCM: Select "PCM" if an active digital output is supplied to an amplifier or other equipment with linear PCM only (or MD recorder or DAT deck).

Playback Disc	OUTPUT		
	Stream/PCM	Dolby Digital/PCM	PCM only
96 kHz Linear PCM DVD	PCM	PCM	PCM
DTS DVD	DTS bit Stream	DTS bit Stream	DTS bit Stream
Dolby Digital DVD	Dolby Digital bit Stream	Dolby Digital bit Stream	PCM
MPEG DVD	MPEG bit Stream	PCM	PCM
Audio CD/Video CD	PCM	PCM	PCM
DTS Audio CD	DTS bit Stream	DTS bit Stream	DTS bit Stream

Initial Settings

Selecting Digital Audio Output



■ Sampling Frequency

To change the Sample Frequency setting, first select the desired digital audio output type as indicated on page 47. If your A/V receiver or surround processor is NOT capable of handling 96kHz signals, select the 48kHz option. When this choice is made, this unit will automatically convert any 96kHz signals to a 48kHz output so that your system is capable of decoding them. If your A/V receiver or surround processor is capable of handling 96kHz signals, select the 96kHz option. When this choice is made, this unit will pass each type of signal through without any further processing.



- When you are not using the player's digital audio output, don't select any of the options.
- If an active digital audio output signal is supplied to a receiver or other equipment without a corresponding digital decoding capability, a very loud noise may be produced which could permanently damage the speakers.
- The DTS DVD disc sound is played back only when the DVD player is connected to a receiver with a DTS decoder.

Others



The DRC, Vocal and PBC settings can be changed.

1. At the SETUP menu screen, press ▲/▼ to select “Others” and press ►.



2. Press ▲/▼ to select the desired items and press ENTER.

The setting of the selected item are changed between On and Off.

About DRC (Dynamic Range Compression)

With the DVD format you have the opportunity to hear a program's soundtrack in the most accurate and realistic presentation possible, thanks to the use of digital audio technology. However, in certain instances you may wish to slightly compress the dynamic range of the audio output (the difference between the loudest sounds and the quietest ones) so that you may listen to a movie at a lower volume without losing dialogue intelligibility.

■ DRC (Dynamic Range Compression) On/Off

On: Select this option to turn on the Dynamic Range Compression circuitry so that the dialogue remains clear even at low volume levels.

Off: Select this option to turn off the Dynamic Range Compression and have the soundtrack presented exactly as it was created.

■ Vocal On/Off

Set to On only when a multi-channel karaoke DVD is being played. The karaoke channels on the disc will then be mixed into a normal stereo sound.

■ PBC On/Off

Set Playback Control (PBC) to On or Off

On: Video CDs with PBC are played back according to the PBC.

Off: Video CDs with PBC are played back in the same way Audio CDs.

NOTES

- The DRC function works only during playback of Dolby Digital recorded discs.
- The level of Dynamic Range Compression may differ depending on the DVD disc.
- When playing karaoke, connect appropriate audio equipment (such as an amplifier) to the DVD video player.

Table of Languages and their



Enter the appropriate code number for the initial settings “Audio”, “Subtitle” and/or “Menu” (See page 42).

Code	Language	Code	Language	Code	Language	Code	Language
6565	Afar	7079	Faroese	7678	Lingala	8375	Slovak
6566	Abkhazian	7082	French	7679	Laothian	8376	Slovenian
6570	Afrikaans	7089	Frisian	7684	Lithuanian	8377	Samcan
6577	Ameharic	7165	Irish	7686	Latvian, Lettish	8378	Shona
6582	Arabic	7168	Scots Gaelic	7771	Malagasy	8379	Somali
6583	Assamese	7176	Galician	7773	Maori	8381	Albanian
6588	Aymara	7178	Guarani	7775	Macedonian	8382	Serbian
6590	Azerbaijani	7185	Gujarati	7776	Malayalam	8385	Sudanese
6665	Bashkir	7265	Hausa	7778	Mongolian	8386	Swedish
6669	Byelorussian	7273	Hindi	7779	Moldavian	8387	Swahili
6671	Bulgarian	7282	Croatian	7782	Marathi	8465	Tamil
6672	Bihari	7285	Hungarian	7783	Malay	8469	Telugu
6678	Bengali, Bangla	7289	Armenian	7784	Maltese	8471	Tajik
6679	Tibetan	7365	Interlingua	7789	Burmese	8472	Thai
6682	Breton	7378	Indonesian	7865	Nauru	8473	Tigrinya
6765	Catalan	7383	Icelandic	7869	Nepali	8475	Turkmen
6779	Corsican	7384	Italian	7876	Dutch	8476	Tagalog
6783	Czech	7387	Hebrew	7879	Norwegian	8479	Tonga
6789	Welsh	7465	Japanese	7982	Oriya	8482	Turkish
6865	Danish	7473	Yiddish	8065	Panjabi	8484	Tatar
6869	German	7487	Javanese	8076	Polish	8487	Twi
6890	Bhutani	7565	Georgian	8083	Pashto, Pushto	8575	Ukrainian
6976	Greek	7575	Kazakh	8084	Portuguese	8582	Urdu
6978	English	7576	Greenlandic	8185	Quechua	8590	Uzbek
6979	Esperanto	7577	Cambodian	8277	Rhaeto-Romance	8673	Vietnamese
6983	Spanish	7578	Kannada	8279	Rumanian	8679	Volapük
6984	Estonian	7579	Korean	8285	Russian	8779	Wolof
6985	Basque	7583	Kashmiri	8365	Sanskrit	8872	Xhosa
7065	Persian	7585	Kurdish	8368	Sindhi	8979	Yoruba
7073	Finnish	7589	Kirghiz	8372	Serbo-Croatian	9072	Chinese
7074	Fiji	7665	Latin	8373	Singhalese	9085	Zulu

Connecting to a TV

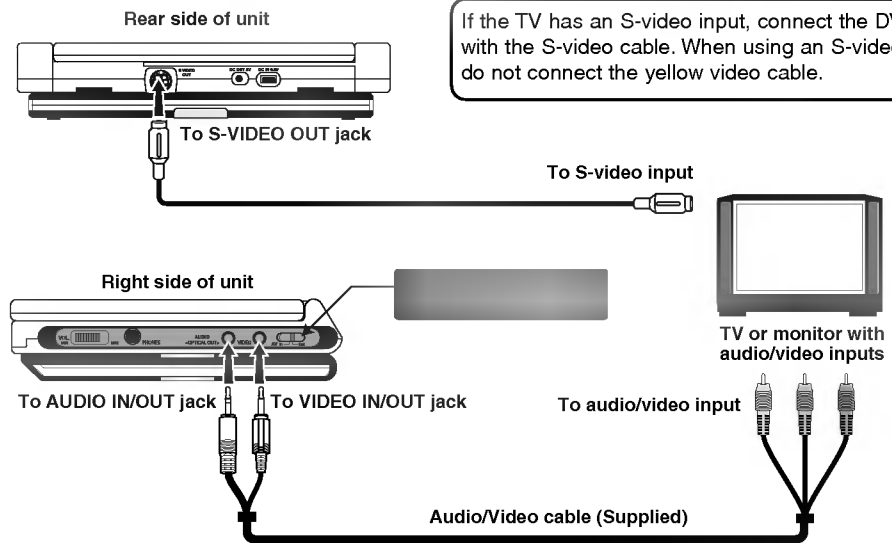

If the TV has an S-video input, connect the DVD player with the S-video cable. When using an S-video cable, do not connect the yellow video cable.



- Refer to the owner's manual of your TV as well.
- Before you connect the DVD player to your TV, be sure to turn off the power and unplug both units from the wall outlet before making any connections.
- **Connect the DVD player to your TV directly. If you connect the DVD player to a VCR, the playback picture will be distorted because DVD video discs are copy protected.**

Connecting to an amplifier equipped with a Dolby Digital decoder

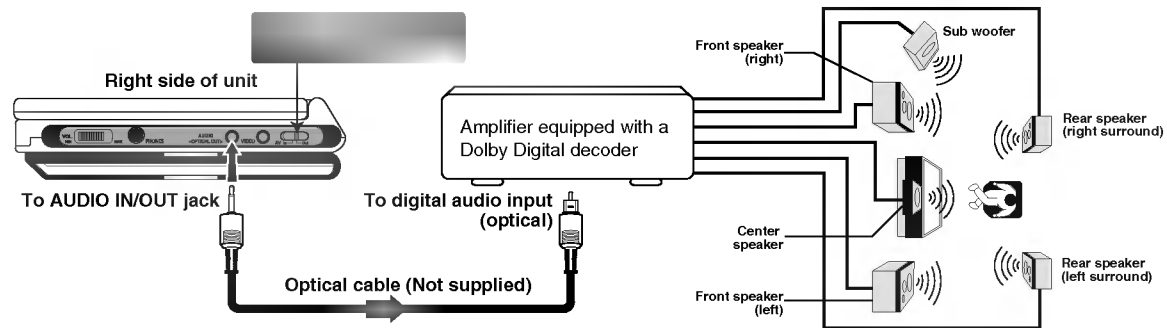

To enjoy Dolby Digital sound from this DVD player you need the following:

- DVD recorded in Dolby Digital
- 6 channel receiver equipped with a Dolby Digital decoder, or Dolby Digital processor and power receiver
- 5 speakers and 1 sub woofer
- Set the Digital Audio Output of this DVD player to "Dolby Digital" from the SETUP menu

Manufactured under license from Dolby Laboratories. "Dolby", "Pro Logic", and the double-D symbol are trademarks of Dolby Laboratories. Confidential Unpublished works. Copyright 1992-1997 Dolby Laboratories. All rights reserved.

Connecting to an amplifier equipped with Dolby Pro Logic Surround

Dolby Pro Logic Surround

You can still enjoy the excitement of Surround Sound even if your A/V receiver does not offer Dolby Digital decoding. If your A/V receiver has a Dolby Pro Logic decoder, refer to the following connection diagram.

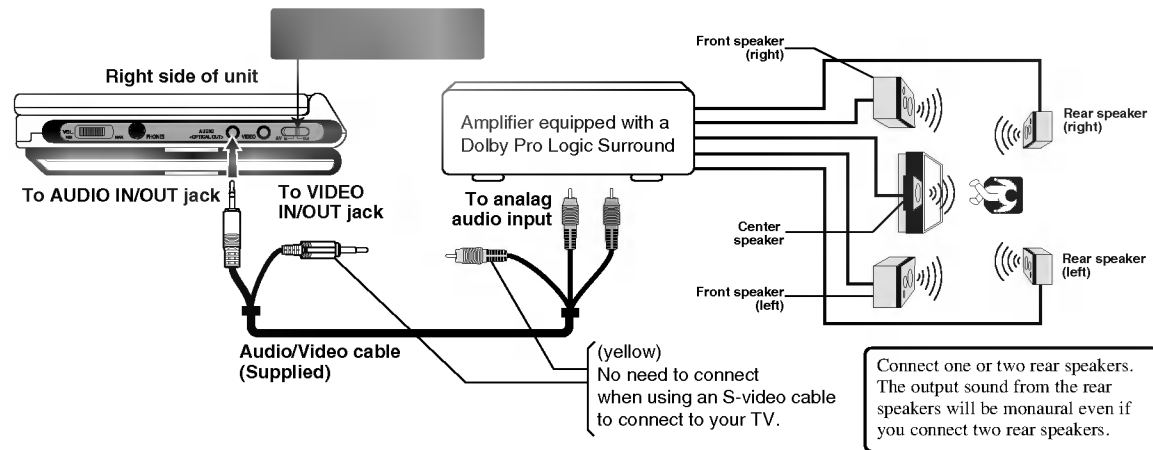

- With a receiver equipped with Dolby Digital**
 Connect the equipment the same way as described in "Connecting to an amplifier equipped with a Dolby Digital decoder" on the previous page. Refer to that receiver's owner's manual and set the receiver so you can enjoy Dolby Pro Logic Surround sound.

NOTE Be sure to set Digital Audio Output of this DVD player to "PCM" from the SETUP menu when you enjoy sounds of Dolby Pro Logic Surround using this connection.

Connecting to an amplifier equipped with a DTS decoder

Digital Theater System(DTS)

DTS is high quality surround technology used in theaters and now available for home use, on DVD video discs or audio CDs. If you have a DTS decoder or processor, you can obtain the full benefit of 5.1 channel DTS encoded sound tracks on DVD video discs or audio CDs.

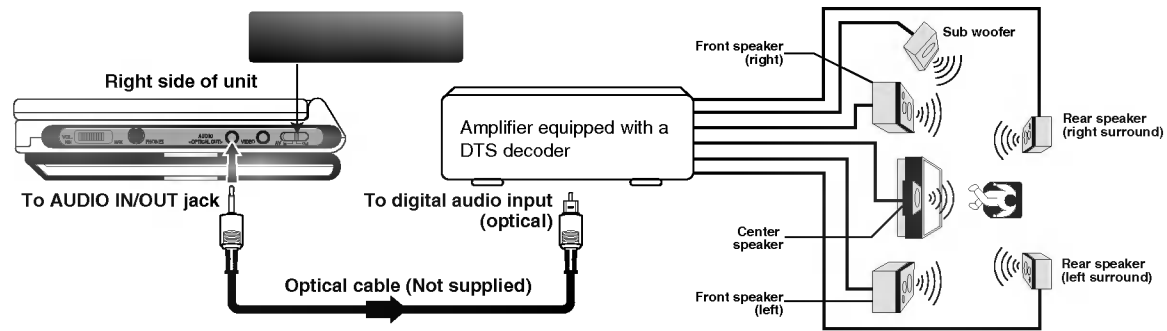

“DTS” and “DTS Digital Out” are trademarks of Digital Theater Systems, Inc.

WARNING:

- When you are connecting (via the OPTICAL OUT jack) an AV decoder that does not have the Dolby Digital, Digital Theater System (DTS) or MPEG2 decoding, be sure to set Digital Audio Output of this DVD player to “PCM” from the SETUP menu. Otherwise, high volume sound may damage your hearing as well as the speakers.

Connecting to an amplifier equipped with a digital audio input

2 Channel Digital Stereo

You can enjoy the dynamic sound of 2 Channel Digital Stereo by connecting this DVD player to a receiver equipped with a digital audio input and speaker system (right and left front speakers).

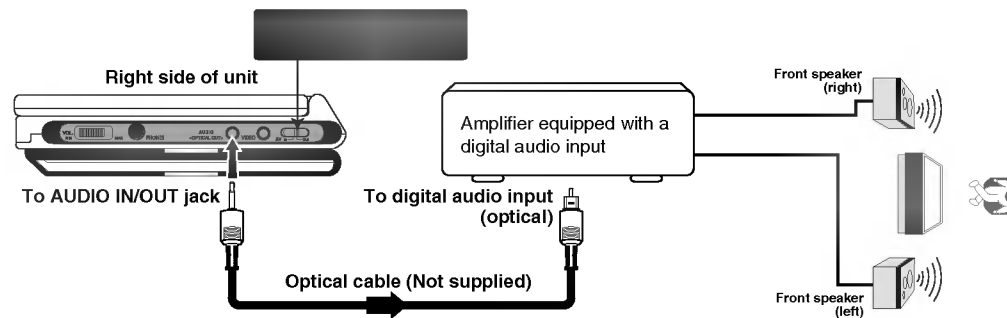



NOTES for all connections

- Connect the OPTICAL OUT jack of the player to the “OPTICAL” input of a Receiver or Processor.
- Refer to the owner’s manual of your audio equipment as well.
- Before you connect the DVD player to other equipment, be sure to turn off the power and unplug all of the equipment from the wall outlet before making any connections.
- The output sound of the DVD player has a wide dynamic range. Be sure to adjust the receiver’s volume to a moderate listening level. Otherwise, the speakers may be damaged by a sudden high volume sound.
- Turn off the receiver before you connect or disconnect the DVD player’s power cord. If you leave the receiver power on, the speakers may be damaged.

Disc Requirements

Playable Discs

This DVD playback disc can play back the following discs.

	Disc mark	Contents	Disc size	Maximum playback time
DVD video discs		Audio+Video (moving pictures)	12 cm	Approx. 4 hours (single sided disc)
				Approx. 8 hours (double sided disc)
			8 cm	Approx. 80 minutes (single sided disc)
				Approx. 160 minutes (double sided disc)
Video CDs		Audio+Video	12 cm	74 minutes
			8 cm	20 minutes
Audio CDs		Audio	12 cm	74 minutes
			8 cm	20 minutes

In addition, this unit can play back a SVCD, CD-R or CD-RW that contains audio titles or MP3 files.

You cannot playback discs other than those listed above. (CVD, CD-ROM, CD-Extra, CD-G, photo CD, and CD-i discs can not be played on this DVD player.)

Copyright Information

Region Management Information: This DVD Player is designed and manufactured to respond to the Region Management Information that is recorded on a DVD disc. If the Region number described on the DVD disc does not correspond to the Region number of this DVD player, this DVD player cannot play that disc.

The Region number of this DVD player is 1.



You may not be able to play back some DVD video discs on this player if they were purchased from outside your geographic area or made for business purposes.

When you try to play back an unauthorized disc, “**Check Regional Code**” appears on the TV screen.

It is forbidden by law to copy, broadcast, show, broadcast on cable, play in public, and rent copyrighted material without permission.

DVD video discs are copy protected, and any recordings made from these discs will be distorted.

This product incorporates copyright protection technology that is protected by method claims of certain U.S. patents and other intellectual property rights owned by Macrovision Corporation and other rights owners. Use of this copyright protection technology must be authorized by Macrovision Corporation, and is intended for home and other limited viewing uses only, unless otherwise authorized by Macrovision Corporation. Reverse engineering or disassembly is prohibited.

Before Calling Service Personnel

Symptoms and Correction

Check the following guide for the possible cause of a problem before contacting service.

Symptom	Cause	Correction
No power.	• The power cord is disconnected.	• Plug the power cord into the wall outlet securely.
	• Hold switch is set to HOLD position.	• Release the hold mode.
	• The battery is discharged.	• Recharge the battery.
The power is on, but the DVD player does not work.	• No disc is inserted.	• Insert a disc. (Check that the DVD or, audio CD indicator in the display window is lit.)
No picture on the LCD or TV (including video from another unit).	• The video cable is not connected securely.	• Connect the video cable into the jacks securely.
	• The AV In/Out switch is not set correctly.	• Set the AV In/Out switch correctly. - While you are playing a disc, set the AV In/Out switch to Out mode - While you are viewing video from other equipment, set the AV In/Out switch to In mode.
	• LCD mode is set to OFF.	• Select a LCD mode other than OFF.
	• Check that Brightness control is set to “-”.	• Adjust the brightness.
	• The TV is not set to receive DVD signal output.	• Select the appropriate video input mode on the TV so the picture from the DVD player appears on the TV screen.
	• The connected TV power is turned off.	• Turn on the TV.

Before Calling Service Personnel

Symptom	Cause	Correction
No sound.	<ul style="list-style-type: none"> The equipment connected with the audio cable is not set to receive DVD signal output. 	<ul style="list-style-type: none"> Select the correct input mode of the audio receiver so you can listen to the sound from the DVD player.
	<ul style="list-style-type: none"> The audio cables are not connected securely. 	<ul style="list-style-type: none"> Connect the audio cable into the jacks securely.
	<ul style="list-style-type: none"> The power of the equipment connected with the audio cable is turned off. 	<ul style="list-style-type: none"> Turn on the equipment connected with the audio cable.
	<ul style="list-style-type: none"> The Digital Audio Output is set to the wrong position. 	<ul style="list-style-type: none"> Set the Digital Audio Output to the correct position, then turn on the DVD player again.
The playback picture is poor.	<ul style="list-style-type: none"> The disc is dirty. 	<ul style="list-style-type: none"> Clean the disc.
The DVD player does not start playback.	<ul style="list-style-type: none"> No disc is inserted. 	<ul style="list-style-type: none"> Insert a disc. (Check that the disc indicator in the display window is lit.)
	<ul style="list-style-type: none"> An unplayable disc is inserted. 	<ul style="list-style-type: none"> Insert a playable disc. (Check the disc type, color system and Regional code.)
	<ul style="list-style-type: none"> The disc is placed upside down. 	<ul style="list-style-type: none"> Place the disc with the playback side down.
	<ul style="list-style-type: none"> The disc is not placed within the guide. 	<ul style="list-style-type: none"> Place the disc on the disc tray correctly inside the guide.
	<ul style="list-style-type: none"> A menu is on the TV screen. 	<ul style="list-style-type: none"> Press the SETUP button to turn off the menu screen.
	<ul style="list-style-type: none"> The Rating level is set. 	<ul style="list-style-type: none"> Cancel the Rating function or change the rating level.

Reference

Before Calling Service Personnel

Symptom	Cause	Correction
The LCD is dark.	<ul style="list-style-type: none"> • Check that Brightness control is set to “-”. 	<ul style="list-style-type: none"> • Adjust the brightness.
No response when buttons are pressed.	<ul style="list-style-type: none"> • Some discs prohibit certain operations. 	<ul style="list-style-type: none"> • “⊗” may appear on the screen during operation.
	<ul style="list-style-type: none"> • Hold switch is set to HOLD position. 	<ul style="list-style-type: none"> • Release the hold mode.
The remote control does not work properly.	<ul style="list-style-type: none"> • The remote control is too far from the DVD player. 	<ul style="list-style-type: none"> • Operate the remote control within about 23 ft (7 m).
	<ul style="list-style-type: none"> • There is an obstacle in the path of the remote control and the DVD player. 	<ul style="list-style-type: none"> • Remove the obstacle.
	<ul style="list-style-type: none"> • The batteries in the remote control are exhausted 	<ul style="list-style-type: none"> • Replace the batteries with new ones.

Specifications

[DVD player]	Power supply	DC 9.8 V (AC adapter terminal), DC 7.2 V (Battery)
	Power consumption	25 W with battery
	Weight	12.6 lbs (0.66 kg) (without battery pack)
	External dimensions (W X D X H)	7.3 x 5.9 x 1.0 inches (186 x 150 x 25 mm)
	Signal system	NTSC
	Laser	Semiconductor laser, wavelength 650 nm (DVD), 780 nm (CD)
	Frequency range (audio)	DVD linear sound: 48kHz sampling 4 Hz to 20 kHz 96kHz sampling 4 Hz to 44 kHz
	Signal-to-noise ratio (audio)	More than 95 dB
	Dynamic range (audio)	More than 95 dB
	Harmonic distortion (audio)	0.08 %
	Operating conditions	Temperature: 41°F to 95°F, Operation status: Horizontal
[Connectors]	Video input/output (VIDEO In/Out)	1.0 V (p-p), 75 Ω, negative sync., ø3.5mm mini jack x 1
	S-video output	(Y) 1.0 V (p-p), 75 Ω, negative sync., Mini DIN 4-pin x 1 (C) 0.286 V (p-p), 75 Ω
	Audio output (optical audio)	Optical connector (ø3.5mm) x 1
	Audio input/output (AUDIO In/Out, analog audio)	1.6 Vrms(1 KHz, 0 dB), ø3.5mm mini jack x 1
	Earphone terminal	ø3.5mm stereo mini jack x 1

Reference

Specifications (Cont'd)

[Liquid Crystal Display]	Panel size	7 inches (16:9)
	Projection system	TN color transmission
	Driving system	TFT active matrix
	Resolution	800 x 480 (effective pixel rate: more than 99.99%)
[Supplied Accessories]	<ul style="list-style-type: none"> • S-Video cable1 • RCA Audio/Video cable1 • AC Adapter (AD-DP40).....1 • Power Cord.....1 • Battery Pack (DP-BT40)1 • Remote control1 • Battery for Remote control (Lithium)1 	

* Designs and specifications are subject to change without notice.