



DVD HOME CINEMA SYSTEM

OWNER'S MANUAL

MODEL : DA-3620

(Main Unit: DA-3620AD, Speakers: FE-3620TE, FE-3620WE)



Before connecting, operating or adjusting this product,
please read this instruction booklet carefully and completely.



Safety Precautions



CAUTION
RISK OF ELECTRIC SHOCK
DO NOT OPEN



WARNING: TO REDUCE THE RISK OF ELECTRIC SHOCK DO NOT REMOVE COVER (OR BACK) NO USER-SERVICEABLE PARTS INSIDE REFER SERVICING TO QUALIFIED SERVICE PERSONNEL.



This lightning flash with arrowhead symbol within an equilateral triangle is intended to alert the user to the presence of uninsulated dangerous voltage within the product's enclosure that may be of sufficient magnitude to constitute a risk of electric shock to persons.



The exclamation point within an equilateral triangle is intended to alert the user to the presence of important operating and maintenance (servicing) instructions in the literature accompanying the appliance.

WARNING: TO REDUCE THE RISK OF FIRE OR ELECTRIC SHOCK, DO NOT EXPOSE THIS PRODUCT TO RAIN OR MOISTURE.

CLASS 1 LASER PRODUCT
KLASSE 1 LASER PRODUKT
LUOKAN 1 LASER LAITE
CLASS 1 LASER APPARAT
CLASSE 1 PRODUCT LASER

CAUTION:

This Digital Video Disc Receiver employs a Laser System.

To ensure proper use of this product, please read this owner's manual carefully and retain for future reference, should the unit require maintenance, contact an authorized service location—see service procedure.

Use of controls, adjustments or the performance of procedures other than those specified herein may result in hazardous radiation exposure.

To prevent direct exposure to laser beam, do not try to open the enclosure. Visible laser radiation when open. DO NOT STARE INTO BEAM.

CAUTION: The apparatus shall not be exposed to water, dripping or splashing and that no objects filled with liquids, such as vases, shall be placed on the apparatus.



This product is manufactured to comply with the radio interference requirements of EEC DIRECTIVE 89/336/EEC, 93/68/EEC and 73/23/EEC.



Notes on copyrights:

It is forbidden by law to copy, broadcast, show, broadcast via cable, play in public, or rent copyright material without permission.

This product is equipped with copy protection measures developed by Macrovision. Copy protection signals are recorded on some discs. When recording these discs on a VCR, picture noise will appear during playback.

This product incorporates copyright protection technology that is protected by certain U.S. patent claims and other intellectual property rights owned by Macrovision Corporation and other rights owners. Use of this copyright protection technology must be authorized by Macrovision Corporation, and is intended for home and other limited viewing uses only unless otherwise authorized by Macrovision Corporation. Reverse engineering or disassembly is prohibited.

SERIAL NUMBER: The serial number is found on the back of this unit. This number is unique to this unit and not available to others. You should record requested information here and retain this guide as a permanent record of your purchase.

Model No. _____

Serial No. _____

Introduction

Safety Precautions	2
Table of Contents	3
Before Use	4-5
Playable Discs	4
Precautions	5
Notes on Discs	5
About Symbols	5
Front Panel and Display Window	6
Remote Control	7
Rear Panel	8

Preparation

Connections	9-11
Connecting to a TV	9
Connecting to Optional Equipment	10
Antenna Connections	10
Speaker System Connection	11
Speaker Positioning	11
Before Operation	12-16
Sound Mode	12
Sound Level	12
Test Tone	13
Delay Time Setting	13
Setting the delay time in the Dolby Digital and Dolby Pro Logic mode	13
General Explanation	14
On-Screen Display	14
Initial Settings	15-16
• Initial Settings General Operation	15
• Language	15
• Picture	15
• Parental Control	16

Operation

Operation with Radio	17-18
Presetting the radio stations	17
Listening to the radio	17
Reception of RDS (Radio Data System) Stations ..	18
Sleep Timer Setting	18
Dimmer	18
Mute	18
Using Headphone Jack	18
Selecting input source	18
Operation with DVD	19-21
Playing a DVD	19
General Features	19
• Moving to another TITLE	19
• Moving to another CHAPTER/TRACK	19
• Slow Motion	19
• Still Picture and Frame-by-Frame Playback ..	20
• Search	20
• Repeat	20
• Repeat A-B	20
• Time Search	20
• Zoom	21
• Marker Search	21

Special DVD Features	21
• Title Menu	21
• Disc Menu	21
• Camera Angle	21
• Changing the Audio Language	21
• Subtitle	21
Operation with Audio CD and MP3 Disc	22
Playing an Audio CD and MP3 Disc	22
• Pause	22
• Moving to another Track	22
• Repeat Track/All/Off	22
• Search	22
• Repeat A-B	22
• Changing the Audio Channel	22
Programmed Playback	23
Programmed Playback with Audio CD and MP3 Disc	23
Additional Information	24
Last Condition Memory	24
Screen Saver	24
Video Mode Setting	24
Notes on MP3 Discs	24

Reference

Troubleshooting	25-26
Language Code List	27
Country Code List	28
Specification	29

About the symbols for instructions

 Indicates hazards likely to cause harm to the unit itself or other material damage.

 Indicates special operating features of this unit.



 Indicates tips and hints for making the task easier.

Manufactured under license from Dolby Laboratories. "Dolby", "Pro Logic", and the double-D symbol are trademarks of Dolby Laboratories. Confidential Unpublished works. Copyright 1992-1997 Dolby Laboratories. All rights reserved.

Manufactured under license from Digital Theater Systems, Inc. US Pat. No. 5,451,942 and other worldwide patents issued and pending. "DTS" and "DTS Digital Surround" are trademarks of Digital Theater Systems, Inc. Copyright 1996 Digital Theater Systems, Inc. All rights reserved.

Before Use

Playable Discs

	DVD (8 cm / 12 cm disc)
	Audio CD (8 cm / 12 cm disc)

In addition, this unit can play a CD-R or CD-RW that contains audio titles or MP3 files.

Notes

- Depending on the conditions of the recording equipment or the CD-R/RW disc itself, some CD-R/RW discs cannot be played on the unit.
- The unit cannot play the CD-R/RW discs that contain no data, or contain different kinds of formatted data other than MP3 and CD-DA data.
- Do not attach any seal or label to either side (the labeled side or the recorded side) of a disc.
- Do not use irregular shaped CDs (e.g., heart-shaped or octagonal). It may result in malfunctions.

Notes on DVDs

Some playback operations of DVDs may be intentionally fixed by software manufacturers. As this unit plays DVDs according to disc content designed by the software manufacturer, some playback features of the unit may not be available, or other functions may be added. Refer also to the instructions supplied with the DVDs. Some DVDs made for business purposes may not be played on the unit.

Regional code of the DVD receiver and DVDs

This DVD receiver is designed and manufactured for playback of region “2” encoded DVD software. The region code on the labels of some DVD discs indicates which type of receiver can play those discs. This unit can play only DVD discs labeled “2” or “ALL”. If you try to play any other discs, the message “Check Regional Code” will appear on the TV screen. Some DVD discs may not have a region code label even though their playback is prohibited by area limits.



Note on DTS-encoded CDs

When playing DTS-encoded CDs, excessive audio level may be heard from the analog stereo output. To avoid possible damage to the audio system, turn down the volume before playing back such discs, adjust the volume gradually, and keep the volume level low. To enjoy DTS Digital Surround™ playback, an external 5.1 channel DTS Digital Surround™ decoder system must be connected to the digital output of the unit.

Disc-related terms

Title (DVD only)

The main film content or accompanying feature content or additional feature content, or music album.

Each title is assigned a title reference number enabling you to locate it easily.

Chapter (DVD only)

Sections of a picture or a musical piece that are smaller than titles.

A title is composed of one or several chapters. Each chapter is assigned a chapter number, enable you to locate the chapter you want. Depending on the disc, no chapters may be recorded.

Track (Audio CD only)

Sections of a picture or a musical piece on an audio CD. Each track is assigned a track number, enabling you to locate the track you want.

Before Use (Cont'd)

Precautions

Handling the unit

When shipping the unit

The original shipping carton and packing materials come in handy. For maximum protection, re-pack the unit as it was originally packed at the factory.

When setting the unit

The picture and sound of a nearby TV, VCR, or radio may be distorted during playback. In this case, position the unit away from the TV, VCR, or radio, or turn off the unit after removing the disc.

To keep the surface clean

Do not use volatile liquids, such as insecticide spray, near the unit. Do not leave rubber or plastic products in contact with the unit for a long period of time. They will leave marks on the surface.

Installing

- Do not install the unit in a confined space, such as a bookcase or built-in cabinet.
- Allow adequate air circulation to prevent internal heat buildup.
- Do not place the unit on surfaces (rugs, blankets, etc.) or near materials (curtains, draperies) that may block the ventilation slots.
- Do not install the unit near heat sources such as radiators or air ducts, or in a place subject to direct sunlight, excessive dust, mechanical vibration or shock.
- Do not place heavy objects on the unit.

Cleaning the unit

To clean the cabinet

Use a soft, dry cloth. If the surfaces are extremely dirty, use a soft cloth lightly moistened with a mild detergent solution. Do not use strong solvents, such as alcohol, benzene, or thinner, as these might damage the surface of the unit.

To obtain a clear picture

The DVD receiver is a high-tech, precision device. If the optical pick-up lens and disc drive parts are dirty or worn down, the picture quality will be poor.

Regular inspection and maintenance are recommended after every 1,000 hours of use. (This depends on the operating environment.)

For details, please contact your nearest dealer.

Notes on Discs

Handling discs

Do not touch the playback side of the disc. Hold the disc by the edges so that fingerprints will not get on the surface.

Do not stick paper or tape on the disc.



Storing discs

After playing, store the disc in its case.

Do not expose the disc to direct sunlight or sources of heat, or leave it in a parked car exposed to direct sunlight, as there may be a considerable temperature increase inside the car.

Cleaning discs

Fingerprints and dust on the disc can cause poor picture quality and sound distortion. Before playing, clean the disc with a clean cloth. Wipe the disc from the center out.

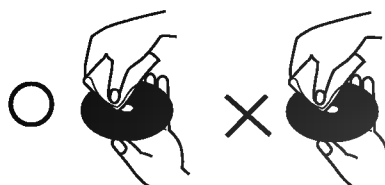

Do not use strong solvents such as alcohol, benzene, thinner, commercially available cleaners, or anti-static spray intended for older vinyl records.



About Symbols

About the symbol display

" " may appear on the TV screen during operation. This icon means the function explained in this owner's manual is not available on that specific DVD video disc.

About the disc symbols for instructions

A section whose title has one of the following symbol is applicable only to the disc represented by the symbol.

-  DVD
-  Audio CDs
-  MP3 disc

Front Panel and Display Window

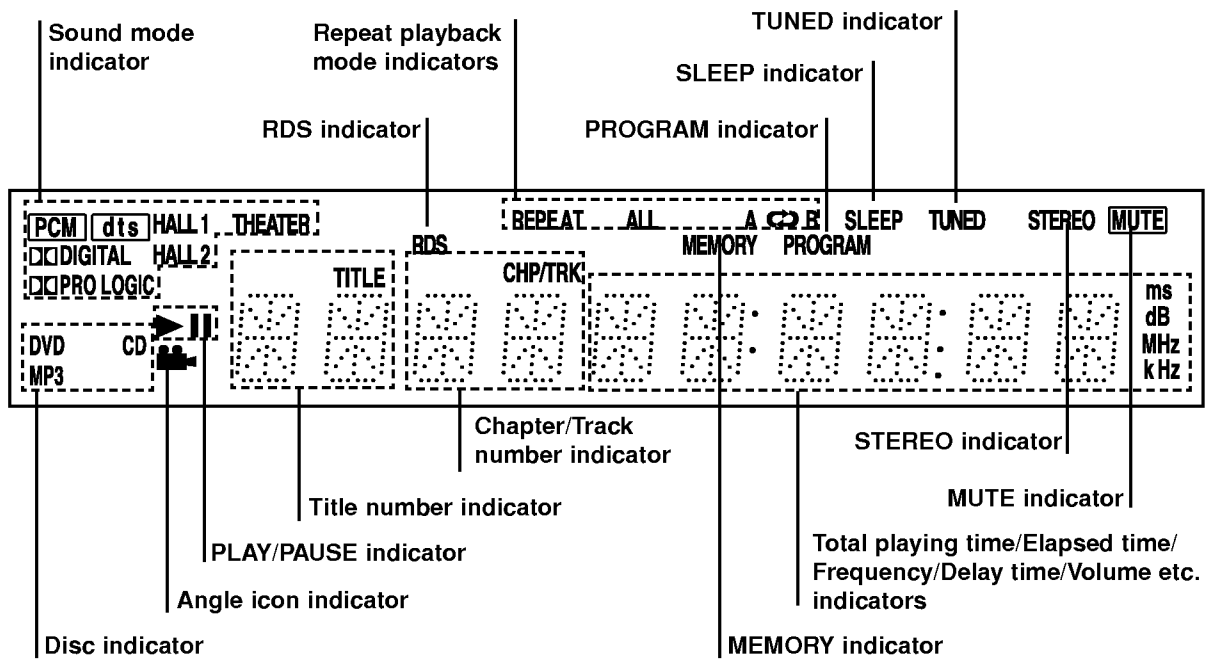
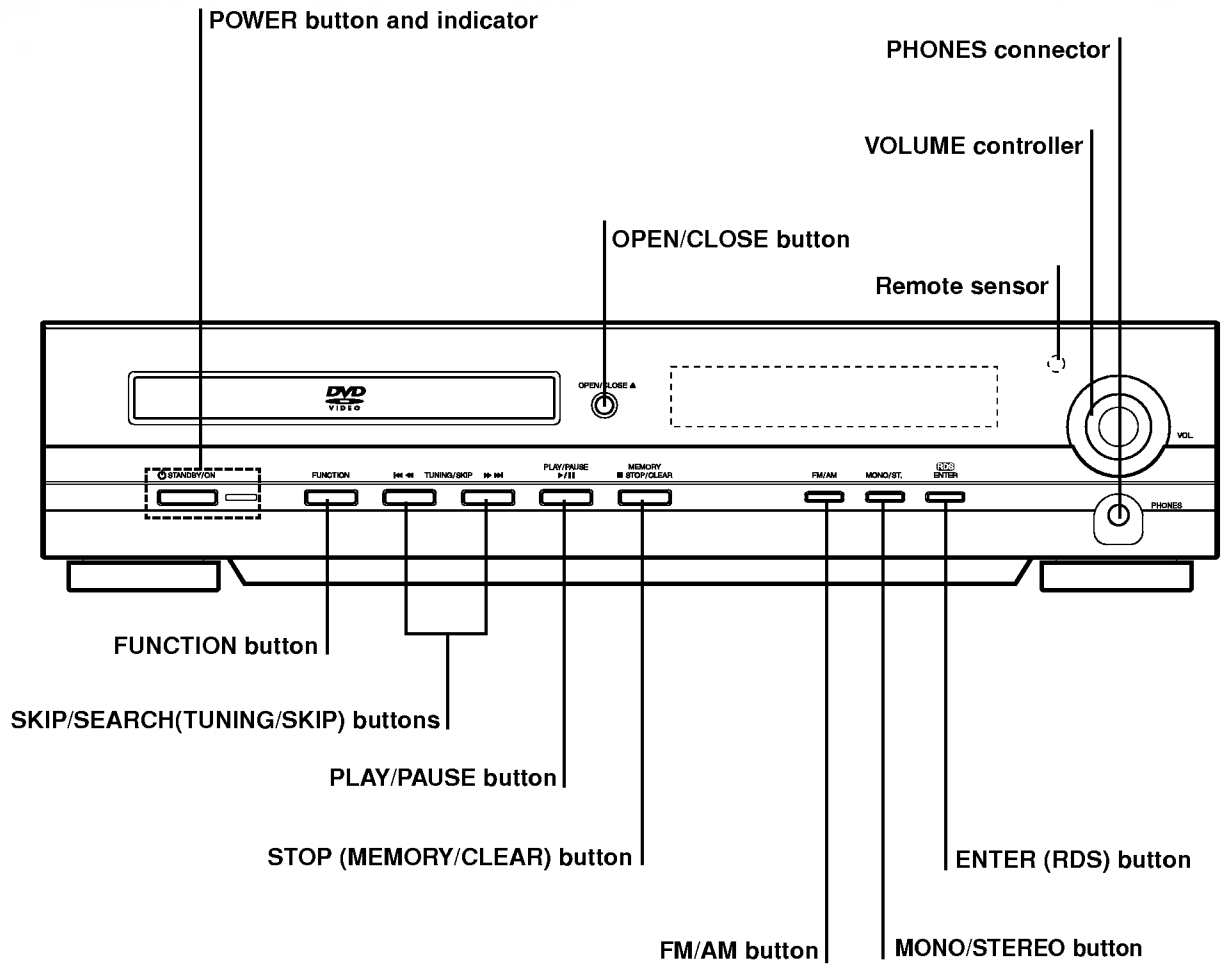

Remote Control

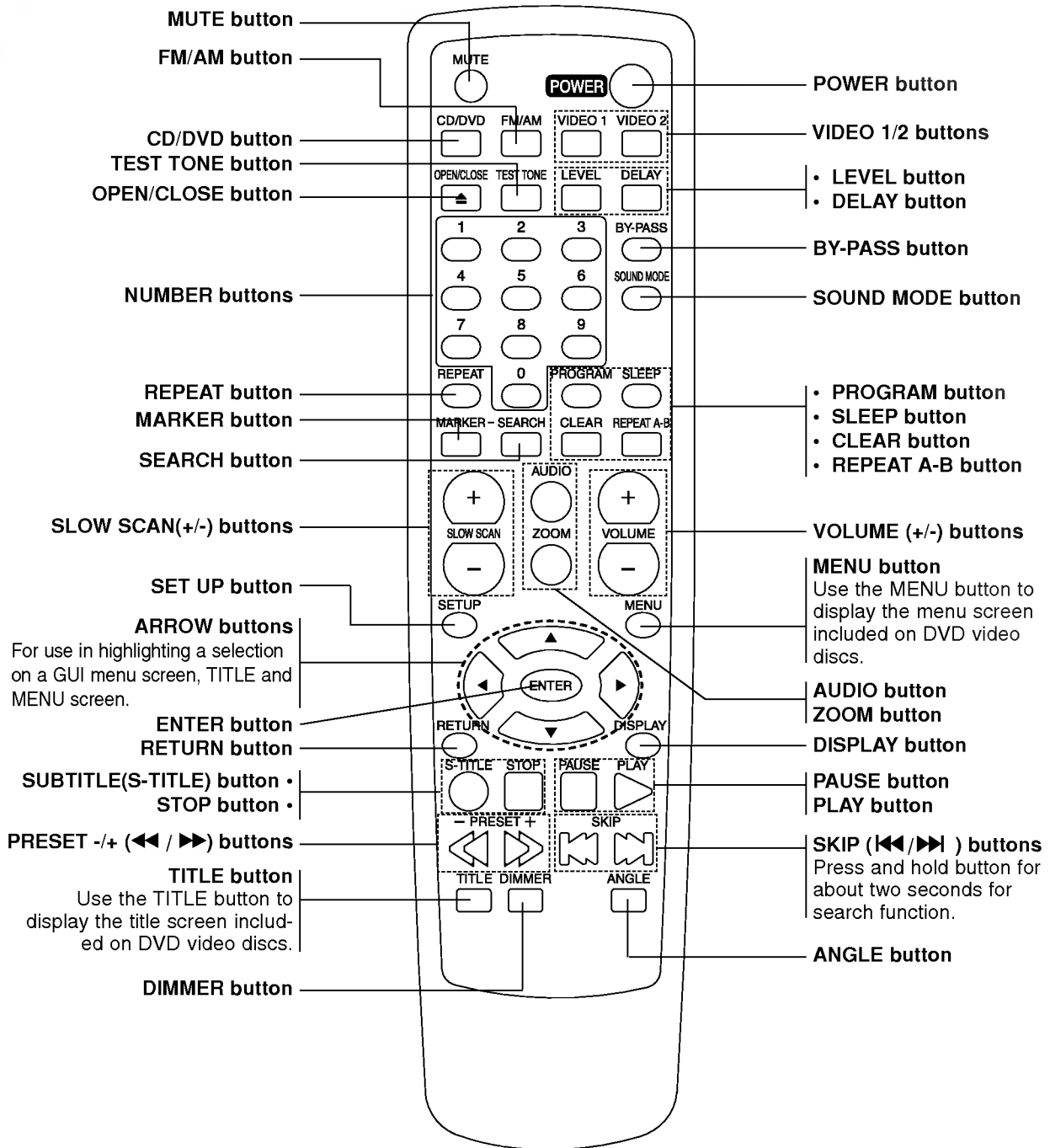

Remote Control Operation Range

Point the remote control at the remote sensor and press the buttons.

- **Distance:** About 23 ft (7 m) from the front of the remote sensor
- **Angle:** About 30° in each direction of the front of the remote sensor

Remote control battery installation

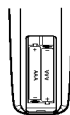

Detach the battery cover on the rear of the remote control, and insert two R03 (size AAA) batteries with **+** and **-** aligned correctly.

⚠ Caution

Do not mix old and new batteries. Never mix different types of batteries (standard, alkaline, etc.).

Rear Panel

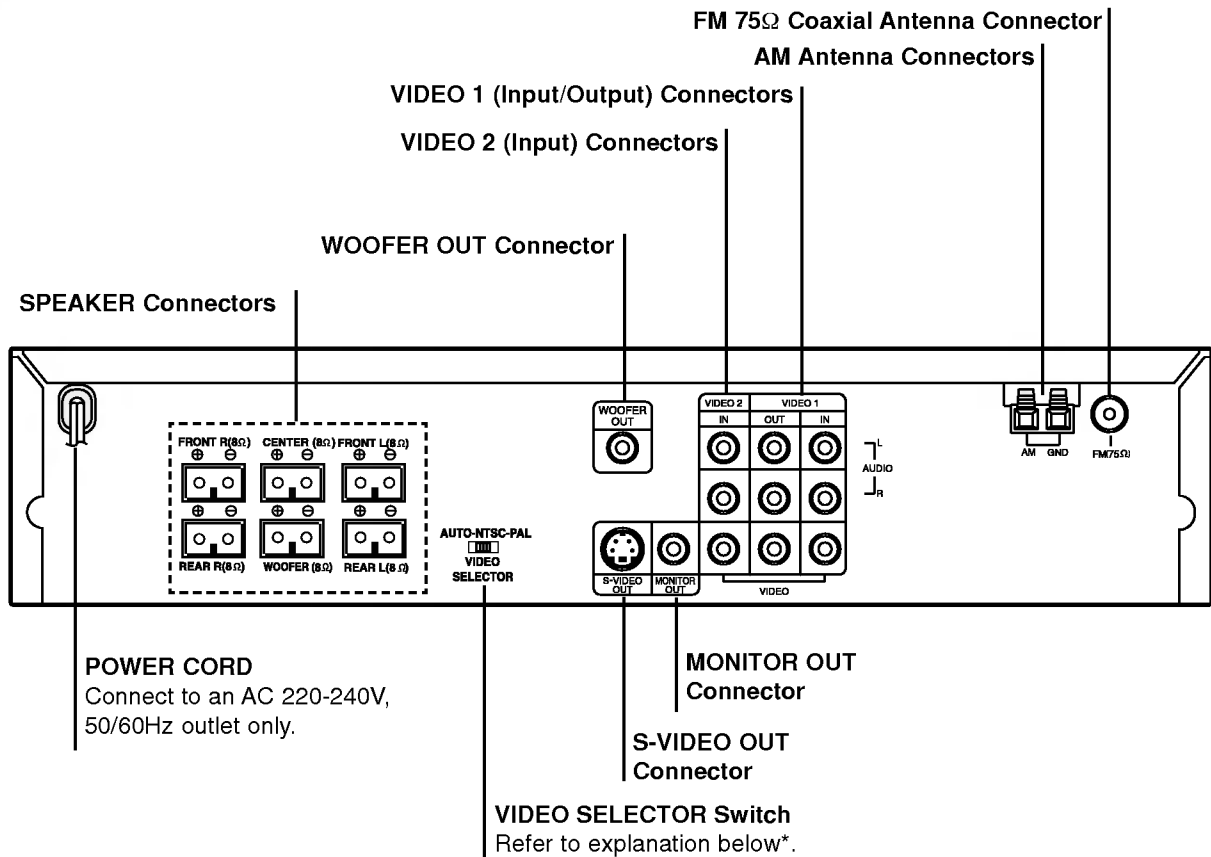

Do not touch the inner pins of the jacks on the rear panel. Electrostatic discharge may cause permanent damage to the unit.



Caution
When you select the function mode to VIDEO1 using the VIDEO1 button on the remote control, the signal is output from the front L/R speakers, but not from the VIDEO1 VIDEO OUT and AUDIO OUT L/R connectors.

* VIDEO SELECTOR switch

You can enjoy NTSC or PAL discs by setting the VIDEO SELECTOR switch to choose the appropriate system.

PAL: Select when DVD receiver is connected with PAL-TV.

NTSC: Select when DVD receiver is connected with NTSC-TV.

AUTO: Select when DVD receiver is connected with Multi system TV.

- When the selected System Select switch does not coincide with the system of your TV, normal color picture may not be displayed.
- Set System Select switch when the power is turned off.

Connections

Connecting to a TV

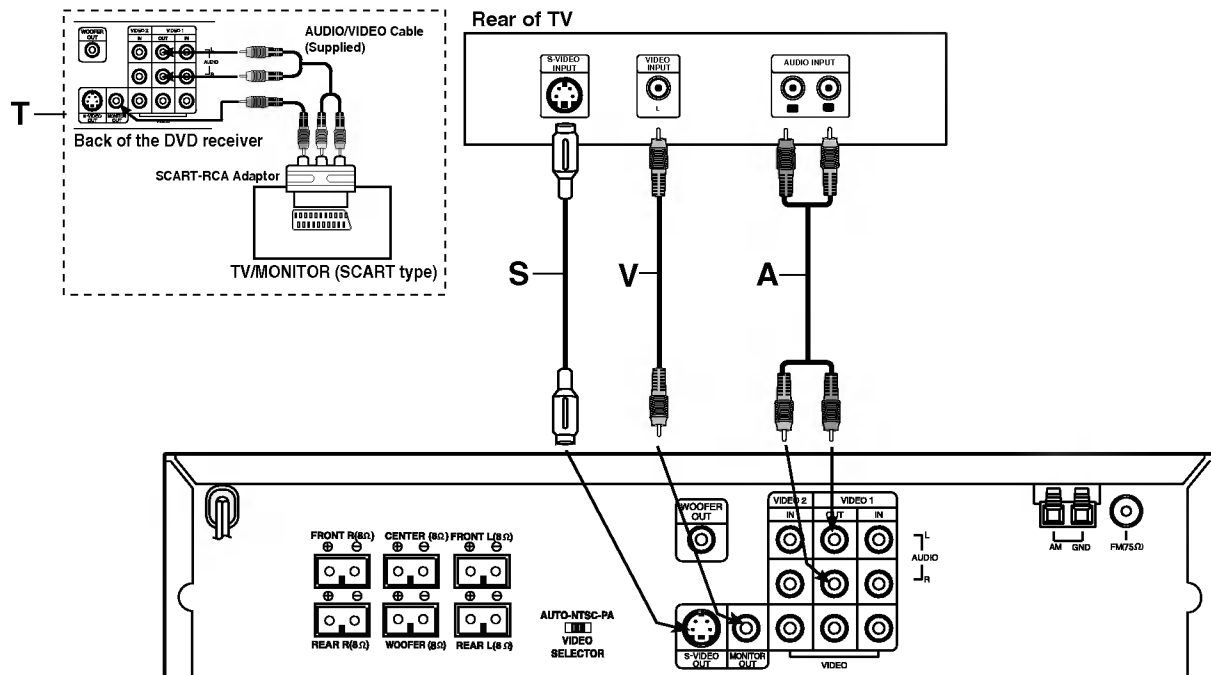

- Make one of the following connections, depending on the capabilities of your existing equipment.

Tips

- Depending on your TV and other equipment you wish to connect, there are various ways you could connect the player. Use one of the connections described below.
- Please refer to the manuals of your TV, VCR, Stereo System or other devices as necessary to make the best connections.

Caution

- Make sure the DVD Receiver is connected directly to the TV. Select the correct AV input on your TV.
- Do not connect your DVD Receiver to TV via your VCR. The DVD image could be distorted by the copy protection system.

Video connection

- 1** Connect the MONITOR OUT jack on the DVD Receiver to the video in jack on the TV using the video cable supplied (V).
- 2** Connect the Left and Right AUDIO OUT jacks of the DVD Receiver to the audio left/right in jacks on the TV (A) using the supplied audio cables.

S-Video connection

- 1** Connect the S-VIDEO OUT jack on the DVD Receiver to the S-Video in jack on the TV using the optional S-Video cable (S).
- 2** Connect the Left and Right AUDIO OUT jacks of the DVD Receiver to the audio left/right in jacks on the TV (A) using the supplied audio cables.

Tip

If you want to connect the DVD receiver to a TV with SCART socket, use the supplied SCART-RCA adaptor (T).

Notes

- The signal of S-VIDEO OUT jack will output only when the function mode is selected to CD/DVD.
- When you connect the DVD receiver to your TV, be sure to turn off the power and unplug both units from the wall outlet before making any connections.

Connections (Cont'd)

Connecting to Optional Equipment

- Connect a TV(Monitor) to the MONITOR OUT or S-VIDEO OUT connector.
- Connect a VCR to the VIDEO 1 connectors.
- Connect a additional VCR to the VIDEO 2 connectors.

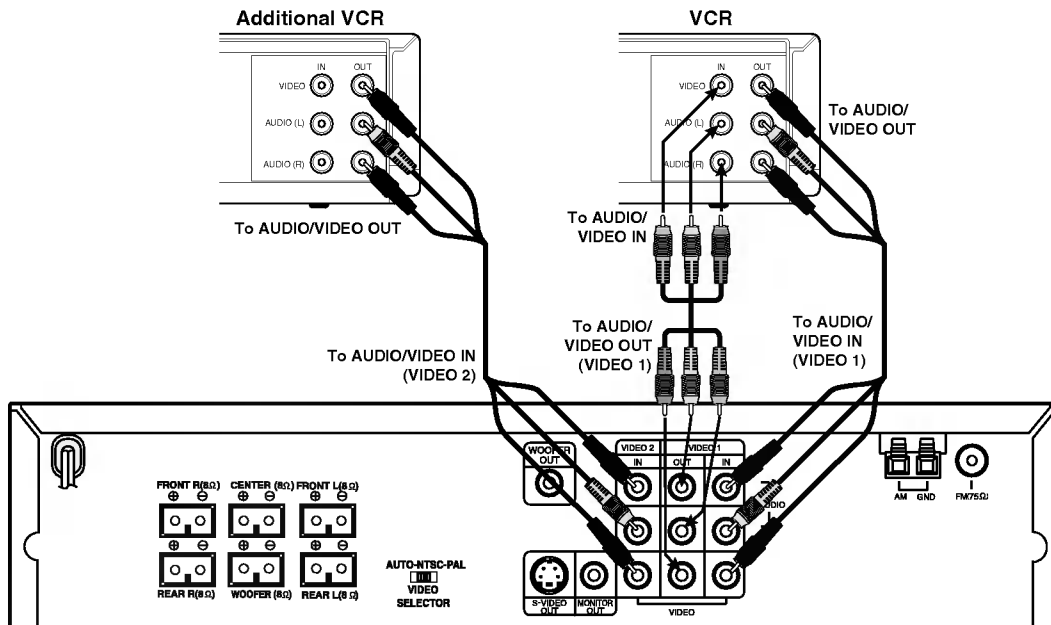

Notes

- When you select the function mode to VIDEO 1, a video signal is not output at the jack.
- If the audio format of the digital output does not match the capabilities of your receiver, the receiver will produce a strong, distorted sound or no sound at all.

Antenna Connections

Connect the supplied FM/AM antennas for listening to the radio.

- Connect the AM loop antenna to the AM antenna connector.
- Connector the FM wire antenna to the FM 75Ω coaxial connector.

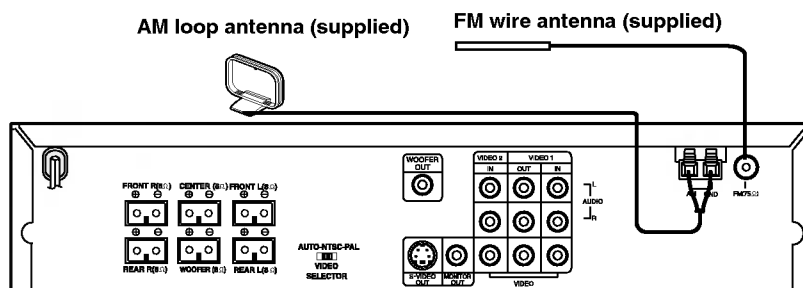

Notes

- To prevent noise pickup, keep the AM loop antenna away from the DVD Receiver and other component.
- Be sure to fully extend the FM wire antenna.
- After connecting the FM wire antenna, keep it as horizontal as possible.

Connections (Cont'd)

Speaker System Connection

Connect the speakers using the supplied speaker cords by matching the colors of the terminals and those of the cords. To obtain the best possible surround sound, adjust the speaker parameters (distance, level, etc.).

N Notes

- Be sure to match the speaker cord to the appropriate terminal on the components: + to + and - to -. If the cords are reversed, the sound will be distorted and will lack base.
- If you use front speakers with low maximum input rating, adjust the volume carefully to avoid excessive output on the speakers.
- Do not disassemble the front cover of supplied speaker.

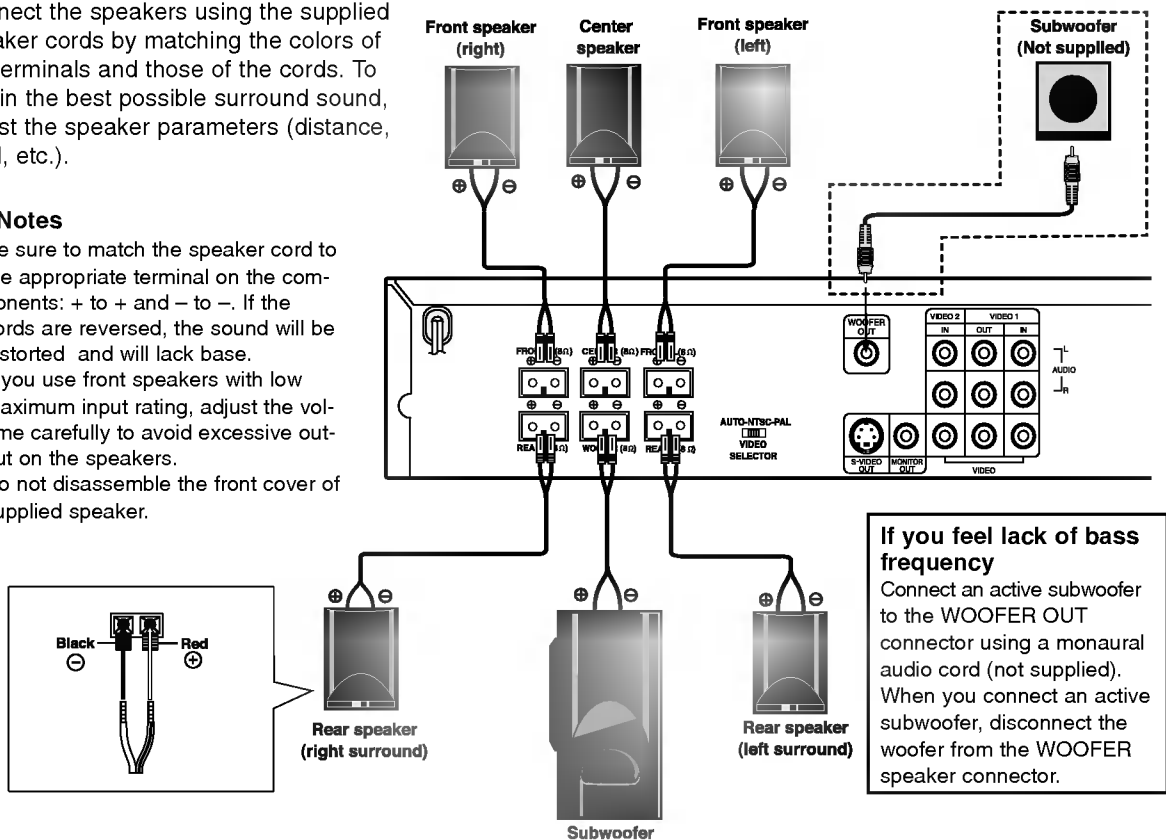

Speaker Positioning

In the case of normal position use the 6 speakers (2 front speakers, center speaker, 2 rear speakers and subwoofer). If you want to play the excellent bass sound, DTS digital surround or Dolby Digital surround, you should connect a subwoofer.

• Front speakers

According to your listening position set up the speakers for equal distance. And by hearing position set up the interval between speakers to 45 degree.

• Center speaker

It is ideal that the center speakers and front speakers are same height. But normally place it above or below the television.

• Rear speakers

Place left and right behind the listening area. These speakers recreate sound motion and atmosphere required for surround playback. For best results, do not install the rear speakers too far behind the listening position and install them at or above the level of the listener's ears. It is also effective to direct the rear speakers towards a wall or ceiling to further disperse the sound.

In the case of a smaller room size, if the audience is near to the rear wall set the rear speakers opposite each other, and set the rear speakers above 60-90cm than the listener's ears.

• Subwoofer

This can be placed in any front position.

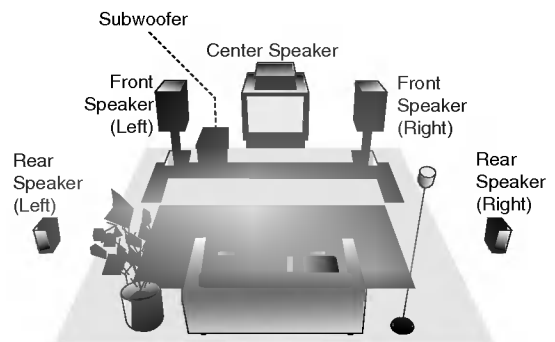

Speaker Positioning Example

Before Operation

Sound Mode

You can enjoy surround sound simply by selecting one of the pre-programmed sound fields according to the program you want to listen to.

Press SOUND MODE repeatedly until the sound mode you want appears in the display window as below.

dts

Allows you to enjoy 5.1 (or 6) discrete channels of high quality digital audio from DTS program sources bearing the trademark such as discs, DVD and compact discs, etc. DTS Digital Surround delivers up to 6 channels of transparent audio (which means identical to the original masters) and results in exceptional clarity throughout a true 360 degree sound field. The term DTS is a trademark of DTS Technology, LLC. Manufactured under license from DTS Technology, LLC.

DIGITAL

The Dolby Digital surround format lets you enjoy up to 5.1 channels of digital surround sound from a Dolby Digital program source. If you play DVDs with the "Dolby Digital" mark, you can enjoy even better sound quality, greater spatial accuracy, and improved dynamic range.

HALL 1

When playing recordings of live music and classic, this mode provides a feeling similar to actually being in a small concert hall.

HALL 2

When playing recordings of live music and classic, this mode provides a feeling similar to actually being in a large concert hall.

THEATER

This mode provides a three dimensional effect similar to that of movie theater.

PRO LOGIC

Use this mode when playing movie or Dolby Digital 2 channel which carries the "Dolby Digital" mark. This mode provides the effect of being in a movie theater or live concert house—an effect with an intensity which can only be obtained through DOLBY PRO LOGIC SURROUND. The effect of the front/back/left/right movement of the sound image, as well as the sense of fixed position in the sound image, is much clearer and more dynamic than before.

2CH STEREO

Outputs the sound from the front left and right speakers and subwoofer. Standard two channel (stereo) sources completely bypass the sound field processing. This allows you to play any source using only the front left and right speakers and subwoofer. **You can select 2CH STEREO by pressing BY-PASS on the remote control.**

When PCM indicator is only displayed in the display window:

Each time you press SOUND MODE button, the sound mode is changed as the following order;

PRO LOGIC → HALL1 → HALL2 → THEATER



Tip

You can select SURROUND OFF (2CH STEREO) mode by pressing BY PASS button.

When DVD is inserted.

You can change the sound mode of DVD (Dolby Digital, DTS, PRO LOGIC, etc) by pressing the AUDIO button on the remote during playback.

Although the DVD contents differ from disc to disc, the following explains the basic operation when this feature is used.

Each time you press AUDIO button, the sound mode of DVD is changed as the following order;

DIGITAL → **dts** → DIGITAL and PRO LOGIC



Tip

You can set PRO LOGIC mode to Off (2CH STEREO) by pressing BY PASS button and the PRO LOGIC indicator disappears.

For your reference

- The DVD Receiver memorizes the last mode settings for each source individually.
- You can identify the encoding format of program software by looking at its packaging.
 - Dolby Digital discs are labeled with the "Dolby Digital" logo.
 - Dolby Surround encoded programs are labeled with the "Dolby Surround" logo.
 - DTS Digital Surround discs are marked with DTS.

Note

When you play sound tracks with 96kHz sampling frequency, the output signals will be converted to 48kHz (sampling frequency).

Sound Level

You can set the sound level of the desired channel.

1 Press LEVEL.

The level indicator will appear in the display window.

2 Press ◀/▶ to select a desired speaker to set.

Each time you press the ◀/▶ button, it is changed as the following order;

FL (Front Left) → C (Center) → FR (Front Right) → SR (Surround Right) → SL (Surround Left) → SW (Subwoofer) → FL (Front Left)

- On the 2 channel stereo mode, you can only select the SW (Subwoofer).

3 Press ▲/▼ to adjust the sound level of the selected channel. (-6dB ~ +6dB)

4 Repeat step 2-3 and adjust the sound level of the other channels.

5 If setting is complete, press LEVEL.

Before Operation (Cont'd)

Test Tone

This function allows you can easily adjust the sound balance of the speakers from the listener's position.

1 Select the test tone mode by pressing TEST TONE.

- A hiss noise comes out for 2 seconds from each speakers in the following order;
FL (Front Left) → C (Center) → FR (Front Right) → SR (Surround Right) → SL (Surround Left) → SW (Subwoofer) → FL (Front Left)

2 You can adjust the sound level during operating the test tone, first press LEVEL then press ▲/▼ buttons, so that all speaker's sound level is same from the listener's position.

- During operating the test tone, if you adjust the sound level, it will be paused in the current speaker channel.

3 If setting is complete, press TEST TONE.

Delay Time Setting

In Dolby Digital or Dolby Pro Logic mode it is assumed that the distance from the listener to each of speakers is equal. If not setting the delay times of the center or rear speakers the sound will be heard simultaneously by the listener.

The interval from the speakers to the listener. If the distance from the listener to each speakers is same, in the Dolby Digital and Dolby Pro Logic mode the delay time of each speakers is as following.

In Dolby Digital mode

Center delay time : 0ms

Rear delay time: 5ms

In Dolby Pro Logic mode

Center delay time : cannot setting

Rear delay time : 15-30ms

If the rear delay time is set in Dolby Digital mode, in the Dolby Pro Logic mode the delay time will be automatically set.

The delay time is 1 msec per 30 cm.

If the center and rear speakers are further than the front speakers from the listener, the delay time will be at minimum.

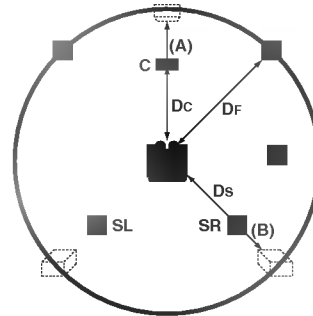

Surround delay time setting

If the distance of Ds is equal to or longer than the DF in the left figure, set the Surround Delay Time as 0ms.

Otherwise, change the setting according to the below.

Ex) If the distance from front speakers to the listener is 3 m and from rear speakers from the listener is 1.5 m, in the Dolby Digital mode the rear delay time is 5 msec.

$$3\text{m (DF)} - 1.5\text{m (Ds)} = 1.5\text{m (B)}$$

$$1.5\text{m (B)} = 150\text{cm} / 30\text{cm} = 5\text{msec}$$

Center delay time setting (Dolby Digital mode only)

If the distance of DF is equal to the distance of Dc in the left figure, set the Center Delay Time as 0ms.

Otherwise, change the setting according to the table below.

Ex) If the distance from the front speakers to the listener is 3m and from the center speaker to the listener is 2.4m, the center delay time is 2msec.

$$3\text{m (DF)} - 2.4\text{m (Dc)} = 60\text{cm (A)}$$

$$60\text{cm (A)} / 30\text{cm} = 2\text{msec}$$

Setting the delay time in the Dolby Digital and Dolby Pro Logic mode

1 Press DELAY.

The current surround delay time appears in the display window.

You can select center delay time by pressing ◀/▶ in the Dolby Digital mode only.

2 Press ▲/▼ to change the delay time.

3 If setting is complete, press DELAY.

Notes

You can adjust the center delay time only in the Dolby Digital mode and its delay time appears.

Before Operation (Cont'd)



Caution:

Before using the remote control, press the DVD or TV button to select the device to be operated.

General Explanation

This manual gives the basic instructions for operating the DVD Receiver. Some DVDs require specific operation or allow only limited operation during playback. When this occurs, the symbol appears on the TV screen, indicating that the operation is not permitted by the DVD Receiver or is not available on the disc.

On-Screen Display

The general playback status can be displayed on the TV screen. Some items can be changed on the menu.

On-screen display operation

1

Press DISPLAY during playback.

2

Press ▲ or ▼ to select an item.
The selected item will be highlighted.

3

Press ◀ or ▶ to change the setting of an item.

The number buttons can be also be used for setting numbers (e.g., title number). For some functions, press ENTER to execute the setting.

Temporary Feedback Field Icons



Repeat Title



Repeat Chapter



Repeat A-B



Repeat Off



Resume play from this point



Action prohibited or not available



Notes

- Some discs may not provide all of the features on the on-screen display example shown below.
- If no button is pressed for 10 seconds, the on-screen display disappears.

Items		Function (Press ▲/▼ to select desired item)	Selection Method
Title Number		Shows the current title number and total number of titles, and skip to the desired title number.	◀ / ▶, or Numeric, ENTER
Chapter Number		Shows the current chapter number and total number of chapters, and skips to the desired chapter number.	◀ / ▶, or Numeric, ENTER, SKIP
Time search		Shows the elapsed playing time, and search the point by the elapsed time directly.	Numeric, ENTER
Audio language and Digital Audio Output mode		Shows the current audio soundtrack language, encoding method and channel number, and changes the setting.	◀ / ▶ AUDIO
Subtitle language		Shows the current subtitles language, and changes the setting.	◀ / ▶ S-TITLE
Angle		Shows the current angle number and total number of angles, and changes the angle number.	◀ / ▶ ANGLE

Before Operation (Cont'd)

Initial Settings

You can set your own Personal Preferences on the player.

Initial Settings General Operation

- 1** Press **SETUP**.
The setup menu appears.



- 2** Press **▲/▼** to select the desired item.
The screen will show the current setting for the selected item, as well as alternate setting(s).
- 3** While the desired item is selected, press **▶**, then **▲/▼** to select the desired setting.
- 4** Press **ENTER** to confirm your selection.
Some items require additional steps.
- 5** Press **SETUP**, **RETURN** or **PLAY** to exit the setup menu.

Language

Disc Language

Select a language for the disc's Menu, Audio and Subtitle.

Original : The original language set for the disc is selected.
Other : To select another language, press number buttons to enter the corresponding 4-digit number according to the language code list on page 27. If you enter the wrong language code, press **CLEAR**.

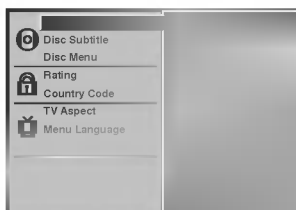

Menu Language

Select a language for the setup menu. This is the menu you see when you press **SETUP**.



Picture

TV Aspect

- 4:3 Letterbox**: Select when a standard 4:3 TV is connected. Displays theatrical images with masking bars above and below the picture.
- 4:3 Panscan**: Select when a standard 4:3 TV is connected. Displays pictures cropped to fill your TV screen. Either sides of the picture are cut off.
- 16:9 Wide**: Select when a 16:9 wide TV is connected.

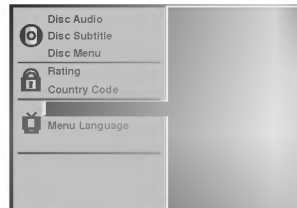

Before Operation (Cont'd)

Parental Control

Rating

Movies on DVDs may contain scenes not suitable for children. Therefore, discs may contain Parental Control information that applies to the complete disc or to certain scenes on the disc. These scenes are rated from 1 to 8, and alternatively, more suitable scenes are available for selection on some discs. Ratings are country dependent. The Parental Control feature allows you to prevent discs from being played by your children or to have certain discs played with alternative scenes.



1 Select "Rating" on the Setup menu using the ▲ and ▼ buttons.

2 While "Rating" is selected, press ►.

3 When you have not entered a password yet; Enter a 4-digit password using the numerical buttons to create a personal 4-digit security password, then press ENTER. And enter the 4-digit password again and press ENTER to verify.

When you have already entered a password; Enter a 4-digit password using the numerical buttons to confirm the personal 4-digit security password, then press ENTER.

If you make a mistake before pressing ENTER, press CLEAR and enter 4-digit security password again.

4 Select a rating from 1 to 8 using the ▲/▼ buttons. One (1) has the least playback restrictions. Eight (8) has the most playback restrictions.

Unlock: If you select Unlock, Parental Control is not active. The disc will play in full.

Ratings 1 to 8: Some discs contain scenes not suitable for children. If you set a rating for the player, all disc scenes with the same rating or lower will be played. Higher rated scenes will not be played unless an alternative scene is available on the disc. The alternative must have the same rating or a lower one. If no suitable alternative is found, playback will stop. You must enter the 4-digit password or change the rating level in order to play the disc.

5 Press ENTER to confirm your rating selection, then press SETUP to exit the menu.

Country Code

Enter the code of a country/area whose standards were used to rate the DVD video disc, referring to the list (See "Country Code List", page 28.).



1 Select Country Code using the ▲ / ▼ buttons on the setup menu.

2 While Country Code is selected, press ►.

3 Follow step 3 of "Rating" on left.

4 Select the first character using the ▲/▼ buttons.

5 Shift the cursor using ◀/▶ buttons and select the second character using ▲/▼ buttons.

6 Press ENTER to confirm your country code selection, then press SETUP to exit the menu.

Note

Confirmation of the 4-digit password is necessary when the code is changed (see "Changing the 4-digit code" below).

Changing the 4-digit code

- 1 Follow steps 1-2 as shown above to the left (Rating).
- 2 Enter the old code, then press ENTER.
- 3 Select Change using the ▲/▼ buttons then press ENTER.
- 4 Enter the new 4-digit code, then press ENTER.
- 5 Enter exactly the same code a second time and verify by pressing ENTER.
- 6 Press SETUP to exit the menu.

If you forget your 4-digit code

If you forget your password, to clear the current password, follow the procedure below.

- 1 Press SETUP to display the setup menu.
- 2 Use the Number buttons to enter the 6-digit number "210499."
The 4-digit password is cleared.
- 3 Enter a new code as shown above to the left (Rating).

Operation with Radio

Presetting the radio stations

You can preset 30 stations for FM and AM. Before tuning, make sure that you have tuned down the volume to the minimum.

1 Press **FUNCTION** on the front panel repeatedly or **FM/AM** on the remote control until the **FM** or **AM** appears in the display window.

2 And then every time you press **FM/AM**, **FM** and **AM** changes alternately.

3 Press and hold **TUNING/SKIP** **◀◀◀** or **▶▶▶** on the front panel for about two seconds until the frequency indication starts to change, then release.

Scanning stops when the DVD Receiver tunes in a station. "TUNED" and "STEREO" (for stereo program) appear in the display window.

Note

"TUNED" only appears when the signal is FM and STEREO.

4 Press **MEMORY**.
A preset number will flash in the display window.

5 Press **TUNING/SKIP** **◀◀◀** or **▶▶▶** on the front panel to select the preset number you want.

6 Press **MEMORY** again.
The station is stored.

7 Repeat steps 3 to 6 to store other stations.

To tune in a station with a weak signal

Press **TUNING/SKIP** **◀◀◀** or **▶▶▶** repeatedly in step 3 to tune in the station manually.

To clear all the memorized stations

Press and hold **MEMORY** for about three seconds and "CLEAR ALL" is appeared in the display window and then press **MEMORY** again, the stations are cleared.

Note

If all stations have already been entered, **FULL** message will appear in the display window for a moment and then a preset number will flash. To change the preset number, follow the steps 5-6 as above.

Listening to the radio

Preset radio stations in the DVD receiver's memory first (see "Presetting radio stations" on the left side).

1 Press **FM/AM** until **AM** or **FM** appears in the display window.

The last received station is tuned in.

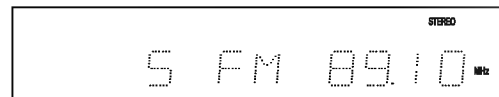

2 Press **PRESET** **◀/▶** repeatedly to select the preset station you want.

Each time you press the button, the DVD receiver tunes in one preset station at a time.

3 Adjust the volume by rotating **VOLUME** on the front panel or by pressing **VOLUME +** or **-** on the remote control repeatedly.

To turn off the radio

Press **POWER** to turn the DVD receiver off or select another function mode (DVD/CD, VIDEO 1 or VIDEO 2).

To listen to non-preset radio stations

- Use manual or automatic tuning in step 2.
- For manual tuning, press **TUNING/SKIP** **◀◀◀** or **▶▶▶** on the front panel repeatedly.
- For automatic tuning, press and hold **TUNING/SKIP** **◀◀◀** or **▶▶▶** for about two seconds on the front panel.

For your reference

- **If an FM program is noisy**
Press **MONO/ST.** on the front panel so that "STEREO" disappears in the display window. There will be no stereo effect, but the reception will improve. Press the button again to restore the stereo effect.
- **To improve reception**
Reorient the supplied antennas.

Operation with Radio (Cont'd)

Reception of RDS (Radio Data System)

Stations

RDS (Radio Data System) is a system gradually being introduced on FM in many countries, where by an inaudible stream of data is transmitted in addition to the normal radio signal. This data contains various information including station/ transmitter identification, traffic information and a list of alternative frequencies for the radio station being received.

1 Press **FUNCTION** to select **FM** or **AM** and then press **FM/AM** to select **FM**.

2 Select a desired station by pressing the **PRE-SET** **◀** or **▶**.

When the RDS transmission is received, the display shows the program service name (PS) after RDS indicator appears.

3 Press **RDS** to recall the frequency.



Note

- RDS is only available for FM reception.
- The PS (PROGRAM SERVICE) NAME is displayed automatically when a RDS station is received.

Sleep Timer Setting

You can set the DVD receiver to turn off automatically at a specified time.

1 Press **SLEEP** to set the desired sleep time.

The **SLEEP** indicator and sleep time appears in the display window.

2 Each time you press **SLEEP**, the setting changes in the following order.

SLEEP 120 → 90 → 60 → 50 → 40 → 30 → 20 → 10 → OFF



Notes

- You can check the time remaining before the DVD receiver turns off.

Press **SLEEP**. The remaining time appears in the display window.

Dimmer

This function will be illuminated the display window in power-on status.

Press the **DIMMER** repeatedly.

Mute

Press **MUTE** to mute your unit.

You can mute your unit in order, for example, to answer the telephone, "MUTE" indicator flashes in the display window.

Using Headphone Jack

Connect a stereo headphone plug (Ø3.5mm) into the **PHONES** connector.

The speakers are automatically disconnected when you plug in the headphones (not supplied).

Selecting input source

You can use VCRs or other units connected to the **VIDEO1** or **VIDEO2** connectors.

Refer to the owner's manual supplied with the unit for farther information on the operation.

Press **VIDEO1** or **VIDEO2** repeatedly on the remote control to select the desired input source.

Each time you press this button, the mode of the function changes in the following sequence:

- **VIDEO1** : For selecting the signal from **VIDEO1** AUDIO IN (L/R) & **VIDEO IN** Connectors.
- **VIDEO2** : For selecting the signal from **VIDEO2** AUDIO IN (L/R) & **VIDEO IN** Connectors.

Operation with DVD

Playing a DVD

Getting to play

- Switch on the TV and select the AV input source connected to the DVD receiver.
- When you want to enjoy the sound of discs or from the audio system, turn on the audio system and select the input source connected to the DVD receiver.

1 Press OPEN/CLOSE to open the disc tray.

2 Load your chosen disc in the tray, with the label facing up.

When a double-sided DVD is inserted, make sure the side you want to play is facing up.

3 Press OPEN/CLOSE to close the tray.

READING appears on the TV screen, and playback starts automatically. If playback does not start, press PLAY.

In some cases, the disc menu might appear instead.

When the menu screen is displayed

The menu screen may be displayed first after loading a DVD which contains a menu.



Use the ◀/▶/▲/▼ buttons to select the title/chapter you want to view, then press ENTER to start playback. Press TITLE or MENU to return to the menu screen.

Notes

- If Parental Control is set and the disc is not within the Rating settings (not authorized), the 4-digit code must be entered and/or the disc must be authorized (see “Parental Control”, on page 16).
- DVDs may have a region code.
- Your player will not play discs that have a region code different from your player. The region code for this player is 2 (two).

General Features

Note

Unless stated, all operations described are based on remote control use. Some operations can be carried out using the setup menu.

Moving to another TITLE



When a disc has more than one title, you can move to another title as follows:

- Press DISPLAY when playback is stopped, then press the appropriate numerical button (0-9) to select a title number.

Moving to another CHAPTER



When a title on a disc has more than one chapter or a disc has more than one track, you can move to another chapter/track as follows:

- Press SKIP ◀◀ or ▶▶ briefly during playback to select the next chapter/track or to return to the beginning of the current chapter/track.
- Press ◀◀ twice briefly to step back to the previous chapter/track.
- To go directly to any chapter during DVD playback, press DISPLAY. Then, press ▲/▼ to select C (chapter). Then, enter the chapter/track number using the numerical buttons (0-9).

Note

For two-digit numbers, press the buttons in rapid succession.

Slow Motion

- 1 Press SLOW SCAN + or - during playback. The player will enter SLOW mode.
- 2 Use the SLOW SCAN + or - to select the required speed: ◀◀ 1/16, ◀◀ 1/8, ◀◀ 1/4 or ◀◀ 1/2 (backward), or ▶▶ 1/16, ▶▶ 1/8, ▶▶ 1/4 or ▶▶ 1/2 (forward).
- 3 To exit slow motion mode, press PLAY.

Operation with DVD (Cont'd)

General Features (cont'd)

Still Picture and Frame-by-frame playback

- 1 Press PAUSE during playback.
The player will now go into PAUSE mode.
- 2 You can advance the picture frame by frame by pressing PAUSE repeatedly on the remote control.

Search

- 1 Press and hold SKIP or for about two seconds during playback.
The player will now go into SEARCH mode.
- 2 Press and hold SKIP or repeatedly to select the required speed: X2, X4, X16, X100 (backward) or X2, X4, X16, X100 (forward).
- 3 To exit SEARCH mode, press PLAY.

Repeat



DVD - Repeat Chapter/Title/Off

- 1 To repeat the currently playing chapter, press REPEAT.
The Repeat Chapter icon appears on the TV screen.
- 2 To repeat the title currently playing, press REPEAT a second time.
The Repeat Title icon appears on the TV screen.
- 3 To exit Repeat mode, press REPEAT a third time.
The Repeat Off icon appears on the TV screen.

Repeat A-B

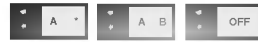

To repeat a sequence in a title:

- 1 Press REPEAT A-B at your chosen starting point.
A- appears briefly on the TV screen.
- 2 Press REPEAT A-B again at your chosen end point.
A-B appears briefly on the TV screen, and the repeat sequence begins (a-b repeat appears on the player's display).
- 3 To cancel the sequence, press REPEAT A-B.

Time Search



The Time Search function allows you to start playing at any chosen time on the disc.

- 1 Press DISPLAY during playback. The on-screen display appears on the screen.
The Time Search box shows the elapsed playing time of the current disc.
- 2 Within 10 seconds, press / to select the Time Search icon in the on-screen display.
The ":-:--:" appears in the Time Search box.
- 3 Within 10 seconds, use the numerical buttons to enter the required start time. Enter hours, minutes and seconds from left to right in the box.
If you enter the wrong numbers, press CLEAR to remove the numbers you entered. Then enter the correct numbers.
- 4 Within 10 seconds, press ENTER to confirm the start time.
Playback starts from the selected time on the disc. If you enter an invalid time, playback will continue from the current point.

Operation with DVD (Cont'd)

General Features (cont'd)

Zoom

The Zoom function allows you to enlarge the video image and to move through the enlarged image.

- 1 Press ZOOM during playback or still playback to activate the Zoom function.
If you press ZOOM repeatedly, the magnification level increases up to six times.
- 2 Use the ◀/▶/▲/▼ buttons to move through the zoomed picture.
- 3 Press CLEAR to resume normal playback or return to the paused image.

Note

- The zoom function may not work for some DVDs.
- The zoom function may not work on multi-angle scenes.

Marker Search



You can start playback from a memorized point. Up to nine points can be memorized.
To enter a mark, follow these steps.

- 1 During disc playback, press MARKER when playback reaches the spot that you want to memorize.
The Marker icon will appear on the TV screen briefly.
- 2 Repeat step 1 to enter up to nine Marker points on a disc.

To Recall a Marked Scene

- 1 During disc playback, press SEARCH.
The MARKER SEARCH menu will appear on the screen.
- 2 Within 10 seconds, press ◀/▶ to select a Marker number that you want to recall.
- 3 Press ENTER.
Playback will start from the Marked scene.
- 4 To remove the MARKER SEARCH menu, press SEARCH.

To clear a Marked Scene

- 1 During disc playback, press SEARCH.
The MARKER SEARCH menu will appear on the screen.
- 2 Press ◀/▶ to select the Marker number that you want to erase.
- 3 Press CLEAR.
The Marker number will be erased from the list.
- 4 Repeat steps 2 and 3 to erase additional Marker numbers.
- 5 To remove the MARKER SEARCH menu, press SEARCH.

Special DVD Features

Checking the contents of DVD discs: Menus

DVDs may contain menus that allow you to access special features. To use the disc menu, press MENU. Then, press the appropriate numerical button to select an item. Or, use the ◀/▶/▲/▼ buttons to highlight your selection, then press ENTER.

Title Menu

- 1 Press TITLE.
If the current title has a menu, the menu will appear on the screen. Otherwise, the disc menu may appear.
- 2 The menu can list camera angles, spoken language and subtitle options, and chapters for the title.
- 3 To remove the title menu, press TITLE again.

Disc Menu

- 1 Press MENU.
The disc menu is displayed.
- 2 To remove the disc menu, press MENU again.

Camera Angle



If the disc contains sequences recorded from different camera angles, the angle icon blinks on the display. You can then change the camera angle if you wish.

- Press ANGLE repeatedly during playback to select a desired angle.
The number of the current angle appears on the display.

Changing the Audio Language



Press AUDIO repeatedly during playback to hear a different audio language or audio track.

Subtitles



Press S-TITLE repeatedly during playback to see the different subtitle languages.

Note

If  appears, the feature is not available on the disc.

Operation with Audio CD and MP3 Disc

Playing an Audio CD and MP3 disc

The DVD Receiver can play MP3 format recordings on CD-ROM, CD-R or CD-RW discs.

Before playing MP3 recordings, read the notes of MP3 Recordings on page 24.

- 1 Insert a disc and close the tray.**
The menu appears on the TV screen.

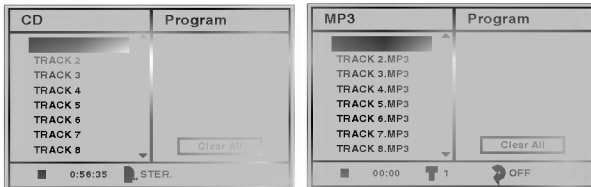

Audio CD menu

MP3 menu

- 2 Press ▲/▼ to select a track then press PLAY.**
Playback starts.
During playback, the current track's elapsed playing time will appear on the display.
Playback will stop at the end of the disc.

- 3 To stop playback at any other time, press STOP.**

Pause

- Press PAUSE during playback.
- To return to playback, press PLAY or press PAUSE again.

Moving to another Track

- Press SKIP **⏮** or **⏭** briefly during playback to go to the next track or to return to the beginning of the current track.
- Press SKIP **⏮** twice briefly to step back to the previous track.
- In case of audio CD, to go directly to any track, enter the track number using the numerical buttons (0-9) during playback.

Repeat TRACK/ALL/OFF

- To repeat the track currently playing, press REPEAT.
The Repeat Track icon appears on the menu screen.
- To repeat all tracks of disc in the unit, press REPEAT a second time.
The Repeat All icon appears on the menu screen.
- To exit Repeat mode, press REPEAT a third time.
The Repeat Off icon appears on the menu screen.

Search

- Press and hold SKIP **⏮** or **⏭** for about two seconds during playback.
The player will now go into SEARCH mode.
- Press and hold SKIP **⏮** or **⏭** repeatedly to select the required speed: **⏮X2**, **⏮X4**, **⏮X8** (backward) or **⏭X2**, **⏭X4**, **⏭X8** (forward).
- Search speed and direction are indicated on the menu screen.
- To exit SEARCH mode, press PLAY.

Note

- The sound is muted during SEARCH mode.

Repeat A-B

To repeat a sequence.

- During disc playback, press REPEAT A-B at your chosen starting point.
The Repeat icon and "A -" appears on the menu screen.
- Press REPEAT A-B again at your chosen end point.
The Repeat icon and "A B" appears on the menu screen, and the sequence begins to play repeatedly.
- To exit the sequence and return to normal play, press REPEAT A-B again.
The Repeat icon and "OFF" appears on the menu screen.

Changing the Audio Channel

Press AUDIO repeatedly during playback to hear a different audio channel (STEREO, LEFT or RIGHT).

Programmed Playback

Programmed Playback with Audio CD and MP3 Disc

Program allows you to store your favorite tracks for a particular disc in the player memory.

Program can contain 32 tracks (Audio CD) or 60 tracks (MP3 disc).

- 1 Insert the disc and close the tray.**
The menu is displayed on the TV screen.

- 2 Press PROGRAM during playback or in the stop mode to enter the Program Edit mode.**

The [E] mark will appear to the right of the word Program on the right side of the menu screen.

Note

Press PROGRAM to exit the Program Edit mode; the [E] mark will disappear.

- 3 Press ▲/▼ to select a track then press ENTER to place the selected track on the Program list.**

- 4 Repeat step 3 to place additional tracks on the Program list.**

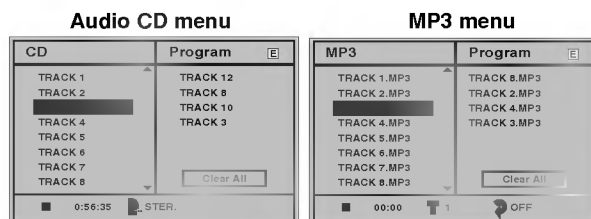

- 5 Press ►.**

The programmed track you selected last is highlighted on the program list.

- 6 Press ▲/▼ to select the track you want to start playing.**

Press TITLE to move to the next page.

Press MENU to move to the previous page.

- 7 Press PLAY to start.**

Playback begins in the order in which you programmed the tracks and "PROGRAM" appears on the menu screen. Playback stops after all of the tracks on the Program list have played once.

Repeat Programmed Tracks

- To repeat the track currently playing, press REPEAT. The Repeat Track icon appears on the menu screen.
- To repeat all tracks of program list, press REPEAT a second time. The Repeat All icon appears on the menu screen.
- To exit Repeat mode, press REPEAT a third time. The Repeat Off icon appears on the menu screen.

Erasing a Track from Program List

- 1 Press PROGRAM during playback or in the stop mode to enter the Program Edit mode.**

The [E] mark will appear.

- 2 Press ► to move to the Program list.**

- 3 Use ▲/▼ to select the track that you wish to erase from the Program list.**

- 4 Press CLEAR.**

The track will be erased from the Program list.

Erasing the Complete Program List

- 1 Follow steps 1-2 of "Erasing a Track from Program List" as above.**

- 2 Use ▲/▼ to select "Clear All", then press ENTER.**

The complete Program for the disc will be erased.

The programs are also cleared when the disc is removed.

To resume normal playback from programmed playback

Press and hold PROGRAM until "PROGRAM" indicator disappears in the display window.

Additional Information

Last Condition Memory

This player memorizes the last condition for the last disc you have watched. Settings remain in memory even if you remove the disc from the player or switch off the player. If you load a disc that has its settings memorized, the latest stop position is automatically recalled.

Notes

- Settings are stored in memory for use any time.
- This player does not memorize settings of a disc if you switch off the player before commencing to play it.

Screen Saver

The screen saver picture appears when you leave the DVD Receiver in stop mode for about five minutes.

Video Mode Setting

- With certain discs, the playback picture may be flickering or Dot Crawl is shown on straight lines. That means Vertical interpolation or De-interlace is not perfectly matched with the disc. In that case, the picture quality can be improved with changing video mode.
- To change the video mode, press and hold DISPLAY for 3 seconds during playback of a disc. Changed video mode number is displayed on the TV screen. Check whether video quality is improved. You can repeat above procedure until desired picture quality appears.
- Procedure of video mode is changed;
MODE1 → MODE2 → MODE3 → MODE4 →
MODE5 → MODE1
- If you turn off the the power, the video mode will be back to initial state (MODE1).

Notes on MP3 Discs

About MP3

- An MP3 file is audio data compressed by using MPEG1, the audio layer-3 file-coding scheme. We call files that have the “.mp3” file extension “MP3 files”.
- The player can not read an MP3 file that has a file extension other than “.mp3”.
- The player can not read a fake MP3 file that has a file extension “.mp3”.

MP3 disc compatible with this player is limited as follows:

1. Sampling Frequency / only at 44.1kHz
2. Bit rate / within 96 - 192kbps
3. CD-R physical format should be “ISO 9660”
4. If you record MP3 files using the software which cannot create a FILE SYSTEM, for example “Direct-CD” etc., it is impossible to playback MP3 files. We therefore recommend that you use “Easy-CD Creator”, which creates an ISO9660 file system.
5. A single session disc requires MP3 files in the first track. If there is no MP3 file in the 1st track, it cannot playback MP3 files. If you wish to playback MP3 files, format all the data in the disc or use a new one.
6. We do not recommend using CD-RW discs. Please use finished CD-R discs only.
7. File names should be named using 8 letters or less and must incorporate “.mp3” extension e.g. “*****.MP3”.
8. Do not use special letters such as “_?!><+*}{[@] ; V . , ” etc.
9. Total number of files on the disc should be less than 200.
10. Use 74 minute CD-R discs (650M), Do not use 80 minute CD-R (700M) software

This DVD receiver requires discs/recordings to meet certain technical standards in order to achieve optimal playback quality. Pre-recorded DVDs are automatically set to these standards. There are many different types of recordable disc formats (including CD-R containing MP3 files).

Customers should also note that permission is required in order to download MP3 files and music from the Internet. Our company has no right to grant such permission. Permission should always be sought from the copyright owner.

Troubleshooting

Check the following guide for the possible cause of a problem before contacting service.

Symptom	Cause	Correction
No power.	<ul style="list-style-type: none"> The power cord is disconnected. 	<ul style="list-style-type: none"> Plug the power cord into the wall outlet securely.
The power is on, but the DVD receiver does not work.	<ul style="list-style-type: none"> No disc is inserted. 	<ul style="list-style-type: none"> Insert a disc. (Check that the DVD or, audio CD indicator in the DVD display is lit.)
No picture.	<ul style="list-style-type: none"> The TV is not set to receive DVD signal output. 	<ul style="list-style-type: none"> Select the appropriate video input mode on the TV so the picture from the DVD receiver appears on the TV screen.
	<ul style="list-style-type: none"> The video cable is not connected securely. 	<ul style="list-style-type: none"> Connect the video cable into the jacks securely.
	<ul style="list-style-type: none"> The connected TV power is turned off. 	<ul style="list-style-type: none"> Turn on the TV.
There is no sound or only a very low-level sound is heard.	<ul style="list-style-type: none"> The equipment connected with the audio cable is not set to receive DVD signal output. 	<ul style="list-style-type: none"> Select the correct input mode of the audio receiver so you can listen to the sound from the DVD receiver.
	<ul style="list-style-type: none"> The audio cables are not connected securely. 	<ul style="list-style-type: none"> Connect the audio cable into the jacks securely.
	<ul style="list-style-type: none"> The power of the equipment connected with the audio cable is turned off. 	<ul style="list-style-type: none"> Turn on the equipment connected with the audio cable.
	<ul style="list-style-type: none"> The audio connecting cord is damaged. 	<ul style="list-style-type: none"> Replace it with new one.
The playback picture is poor.	<ul style="list-style-type: none"> The disc is dirty. 	<ul style="list-style-type: none"> Clean the disc.
The DVD receiver does not start playback.	<ul style="list-style-type: none"> No disc is inserted. 	<ul style="list-style-type: none"> Insert a disc. (Check that the DVD, or audio CD indicator in the DVD display is lit.)
	<ul style="list-style-type: none"> An unplayable disc is inserted. 	<ul style="list-style-type: none"> Insert a playable disc. (Check the disc type, color system and Regional code.)
	<ul style="list-style-type: none"> The disc is placed upside down. 	<ul style="list-style-type: none"> Place the disc with the playback side down.
	<ul style="list-style-type: none"> The disc is not placed within the guide. 	<ul style="list-style-type: none"> Place the disc on the disc tray correctly inside the guide.
	<ul style="list-style-type: none"> The disc is dirty. 	<ul style="list-style-type: none"> Clean the disc.
	<ul style="list-style-type: none"> A menu is on the TV screen. 	<ul style="list-style-type: none"> Press the SET-UP button to turn off the menu screen.
	<ul style="list-style-type: none"> The Rating level is set. 	<ul style="list-style-type: none"> Cancel the Rating function or change the rating level.
Severe hum or noise is heard.	<ul style="list-style-type: none"> The plugs and jacks are dirty. 	<ul style="list-style-type: none"> Wipe them with a cloth slightly moistened with alcohol.
	<ul style="list-style-type: none"> The disc is dirty. 	<ul style="list-style-type: none"> Clean the disc.
	<ul style="list-style-type: none"> The speakers and components are connected poorly. 	<ul style="list-style-type: none"> Connect the speakers and components securely.
	<ul style="list-style-type: none"> The DVD receiver is located with too close to the TV. 	<ul style="list-style-type: none"> Move your TV away from the audio components.

Troubleshooting (Cont'd)

Symptom	Cause	Correction
Recording is not possible.	• The components are connected incorrectly.	• Connect the components correctly.
	• The source is selected in correctly.	• Select the source with FUNCTION button (CD/DVD, VIDEO 1, VIDEO 2 or Tuner).
Radio stations cannot be tuned in.	• The antennas is positioned or connected poorly.	• Connect the antenna securely.
		• Adjust the antennas and connect an external antenna if necessary.
	• The signal strength of the stations is too weak (when tuning in with automatic tuning).	• Tune in the station manually.
	• No stations have been preset or preset stations have been cleared (when tuning by scanning preset stations).	• Preset the stations (page 17).
The remote control does not work properly.	• The remote control is not pointed at the remote sensor of the DVD receiver.	• Point the remote control at the remote sensor of the DVD receiver.
	• The remote control is too far from the DVD receiver.	• Operate the remote control within about 23 ft (7 m).
	• There is an obstacle in the path of the remote control and the DVD receiver.	• Remove the obstacle.
	• The batteries in the remote control are exhausted.	• Replace the batteries with new ones.

Language Code List

Enter the appropriate code number for the initial settings "Disc Audio", "Disc Subtitle" and/or "Disc Menu" (See page 15).

Code	Language	Code	Language	Code	Language	Code	Language
6565	Afar	7079	Faroese	7678	Lingala	8375	Slovak
6566	Abkhazian	7082	French	7679	Laothian	8376	Slovenian
6570	Afrikaans	7089	Frisian	7684	Lithuanian	8377	Samoa
6577	Ameharic	7165	Irish	7686	Latvian, Lettish	8378	Shona
6582	Arabic	7168	Scots Gaelic	7771	Malagasy	8379	Somali
6583	Assamese	7176	Galician	7773	Maori	8381	Albanian
6588	Aymara	7178	Guarani	7775	Macedonian	8382	Serbian
6590	Azerbaijani	7185	Gujarati	7776	Malayalam	8385	Sudanese
6665	Bashkir	7265	Hausa	7778	Mongolian	8386	Swedish
6669	Byelorussian	7273	Hindi	7779	Moldavian	8387	Swahili
6671	Bulgarian	7282	Croatian	7782	Marathi	8465	Tamil
6672	Bihari	7285	Hungarian	7783	Malay	8469	Telugu
6678	Bengali; Bangla	7289	Armenian	7784	Maltese	8471	Tajik
6679	Tibetan	7365	Interlingua	7789	Burmese	8472	Thai
6682	Breton	7378	Indonesian	7865	Nauru	8473	Tigrinya
6765	Catalan	7383	Icelandic	7869	Nepali	8475	Turkmen
6779	Corsican	7384	Italian	7876	Dutch	8476	Tagalog
6783	Czech	7387	Hebrew	7879	Norwegian	8479	Tonga
6789	Welsh	7465	Japanese	7982	Oriya	8482	Turkish
6865	Danish	7473	Yiddish	8065	Panjabi	8484	Tatar
6869	German	7487	Javanese	8076	Polish	8487	Twi
6890	Bhutani	7565	Georgian	8083	Pashto, Pushto	8575	Ukrainian
6976	Greek	7575	Kazakh	8084	Portuguese	8582	Urdu
6978	English	7576	Greenlandic	8185	Quechua	8590	Uzbek
6979	Esperanto	7577	Cambodian	8277	Rhaeto-Romance	8673	Vietnamese
6983	Spanish	7578	Kannada	8279	Rumanian	8679	Volapük
6984	Estonian	7579	Korean	8285	Russian	8779	Wolof
6985	Basque	7583	Kashmiri	8365	Sanskrit	8872	Xhosa
7065	Persian	7585	Kurdish	8368	Sindhi	8979	Yoruba
7073	Finnish	7589	Kirghiz	8372	Serbo-Croatian	9072	Chinese
7074	Fiji	7665	Latin	8373	Singhalese	9085	Zulu

Country Code List

Enter the appropriate code number for the initial setting "Country Code" (See page 16).

Code	Country	Code	Country	Code	Country	Code	Country
AD	Andorra	ER	Eritrea	LC	Saint Lucia	SC	Seychelles
AE	United Arab Emirates	ES	Spain	LI	Liechtenstein	SD	Sudan
AF	Afghanistan	ET	Ethiopia	LK	Sri Lanka	SE	Sweden
AG	Antigua and Barbuda	FI	Finland	LR	Liberia	SG	Singapore
AI	Anguilla	FJ	Fiji	LS	Lesotho	SH	Saint Helena
AL	Albania	FK	Falkland Islands	LT	Lithuania	SI	Slovenia
AM	Armenia	FM	Micronesia	LU	Luxembourg	SJ	Svalbard and Jan Mayen Islands
AN	Netherlands Antilles	FO	Faroe Islands	LV	Latvia	SK	Slovak Republic
AO	Angola	FR	France	LY	Libya	SL	Sierra Leone
AQ	Antarctica	FX	France (European Territory)	MA	Morocco	SM	San Marino
AR	Argentina	GA	Gabon	MC	Monaco	SN	Senegal
AS	American Samoa	GB	Great Britain	MD	Moldavia	SO	Somalia
AT	Austria	GD	Grenada	MG	Madagascar	SR	Suriname
AU	Australia	GE	Georgia	MH	Marshall Islands	ST	Saint Tome and Principe
AW	Aruba	GF	French Guyana	MK	Macedonia	SU	Former USSR
AZ	Azerbaijan	GH	Ghana	ML	Mali	SV	El Salvador
BA	Bosnia-Herzegovina	GI	Gibraltar	MM	Myanmar	SY	Syria
BB	Barbados	GL	Greenland	MN	Mongolia	SZ	Swaziland
BD	Bangladesh	GM	Gambia	MO	Macau	TC	Turks and Caicos Islands
BE	Belgium	GN	Guinea	MP	Northern Mariana Islands	TD	Chad
BF	Burkina Faso	GP	Guadeloupe (French)	MQ	Martinique (French)	TF	French Southern Territories
BG	Bulgaria	GQ	Equatorial Guinea	MR	Mauritania	TG	Togo
BH	Bahrain	GR	Greece	MS	Montserrat	TH	Thailand
BI	Burundi	GS	S. Georgia & S. Sandwich Isls.	MT	Malta	TJ	Tadjikistan
BJ	Benin	GT	Guatemala	MU	Mauritius	TK	Tokelau
BM	Bermuda	GU	Guam (USA)	MV	Maldives	TM	Turkmenistan
BN	Brunei Darussalam	GW	Guinea Bissau	MW	Malawi	TN	Tunisia
BO	Bolivia	GY	Guyana	MX	Mexico	TO	Tonga
BR	Brazil	HK	Hong Kong	MY	Malaysia	TP	East Timor
BS	Bahamas	HM	Heard and McDonald Islands	MZ	Mozambique	TR	Turkey
BT	Bhutan	HN	Honduras	NA	Namibia	TT	Trinidad and Tobago
BV	Bouvet Island	HR	Croatia	NC	New Caledonia (French)	TV	Tuvalu
BW	Botswana	HT	Haiti	NE	Niger	TW	Taiwan
BY	Belarus	HU	Hungary	NF	Norfolk Island	TZ	Tanzania
BZ	Belize	ID	Indonesia	NG	Nigeria	UA	Ukraine
CA	Canada	IE	Ireland	NI	Nicaragua	UG	Uganda
CC	Cocos (Keeling) Islands	IL	Israel	NL	Netherlands	UK	United Kingdom
CD	Central African Republic	IN	India	NO	Norway	UM	USA Minor Outlying Islands
CG	Congo	IO	British Indian Ocean Territory	NP	Nepal	US	United States
CH	Switzerland	IQ	Iraq	NR	Nauru	UY	Uruguay
CI	Ivory Coast	IR	Iran	NU	Niue	UZ	Uzbekistan
CK	Cook Islands	IS	Iceland	NZ	New Zealand	VA	Vatican City State
CL	Chile	IT	Italy	OM	Oman	VC	Saint Vincent & Grenadines
CM	Cameroon	JM	Jamaica	PA	Panama	VE	Venezuela
CN	China	JO	Jordan	PE	Peru	VG	Virgin Islands (British)
CO	Colombia	JP	Japan	PF	Polynesia (French)	VI	Virgin Islands (USA)
CR	Costa Rica	KE	Kenya	PG	Papua New Guinea	VN	Vietnam
CS	Former Czechoslovakia	KG	Kyrgyzstan	PH	Philippines	VU	Vanuatu
CU	Cuba	KH	Cambodia	PK	Pakistan	WF	Wallis and Futuna Islands
CV	Cape Verde	KI	Kiribati	PL	Poland	WS	Samoa
CX	Christmas Island	KM	Comoros	PM	Saint Pierre and Miquelon	YE	Yemen
CY	Cyprus	KN	Saint Kitts & Nevis Anguilla	PN	Pitcairn Island	YT	Mayotte
CZ	Czech Republic	KP	North Korea	PR	Puerto Rico	YU	Yugoslavia
DE	Germany	KR	South Korea	PT	Portugal	ZA	South Africa
DJ	Djibouti	KW	Kuwait	PW	Palau	ZM	Zambia
DK	Denmark	KY	Cayman Islands	PY	Paraguay	ZR	Zaire
DM	Dominica	KZ	Kazakhstan	QA	Qatar	ZW	Zimbabwe
DO	Dominican Republic	LA	Laos	RE	Reunion (French)		
DZ	Algeria	LB	Lebanon	RO	Romania		
EC	Ecuador			RU	Russian Federation		
EE	Estonia			RW	Rwanda		
EG	Egypt			SA	Saudi Arabia		
EH	Western Sahara			SB	Solomon Islands		



[General]	Power supply	AC 220-240V, 50/60Hz		
	Power consumption	70 W		
	Mass	4.6 kg		
	External dimensions (W x H x D)	360 x 72 x 350 mm		
	Operating conditions	Temperature: 5°C to 35°C, Operation status: Horizontal		
	Operating humidity	5% to 85%		
[CD/DVD]	Laser	Semiconductor laser, wavelength 650 nm		
	Signal system	PAL 625/50, NTSC 525/60		
	Frequency response (audio)	4 Hz to 20 kHz		
	Signal-to-noise ratio (audio)	More than 75 dB (1 kHz, NOP, 20 kHz LPF/A-Filter)		
	Dynamic range (audio)	More than 75 dB		
	Harmonic distortion (audio)	0.5 % (1 kHz, at 12W position) (20 kHz LPF/A-Filter)		
[Video]	Video input	1.0 V (p-p), 75 Ω, negative sync., RCA jack		
	Video output	1.0 V (p-p), 75 Ω, negative sync., RCA jack		
	S-video output	(Y) 1.0 V (p-p), 75 Ω, negative sync., Mini DIN 4-pin x 1 (C) 0.3 V (p-p), 75 Ω		
[Tuner]	FM	Tuning Range	87.5 - 108 MHz	
		Intermediate Frequency	10.7 MHz	
		Signal-to Noise Ratio	60 dB	
	AM (MW)	Frequency Response	150 - 12000 Hz	
		Tuning Range	522 - 1611 kHz	
		Intermediate Frequency	450 kHz	
[Amplifier]	Stereo mode	35W + 35W (8 Ω at 1 kHz, THD 10 %)		
	Surround mode (* Depending on the sound mode settings and the source, there may be no sound output.)	Front: 35W + 35W (THD 10 %) Center*: 35W Surround*: 35W + 35W (8Ω at 1 kHz, THD 10 %) Subwoofer*: 35W (8Ω at 30 Hz, THD 10 %)		
	Inputs	VIDEO 1, VIDEO 2		
	Outputs	VIDEO 1 (AUDIO OUT) : 2 V WOOFER: 2 V PHONES: (32 Ω)		
[Speakers]		Satellite Speaker (FE-3620TE)	Passive Subwoofer (FE-3620WE)	
	Type	1 Way 1 Speaker	1 Way 1 Speaker	
	Impedance	8 Ω	8 Ω	
	Frequency Response	120 - 20000 Hz	45 - 1500 Hz	
	Sound Pressure Level	83 dB/W (1m)	82 dB/W (1m)	
	Rated Input Power	35W	35 W	
	Max. Input Power	70 W	70 W	
	Net Dimensions (W x H x D)	90 x 70 x 106.5 mm	160 x 350 x 325 mm	
Net Weight	0.65 kg	4.5kg		
[Supplied Accessories]	• Audio cable1	• Video cable1
	• Speakers6	• Speaker cables5
	• Remote control1	• Batteries (AAA)2
	• AM loop antenna1	• FM antenna1
	• RCA-SCART Adaptor1		

* Designs and specifications are subject to change without notice.



P/NO : 3828R-D019G