

# Room Air Conditioner (Window Type) **OWNER'S MANUAL**

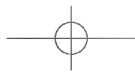

P/No.: 3828A30056C





Safety Precautions

**Safety precautions**

Safety Precautions .....3

Operating Instructions

**Operating Instructions**

About the Controls on the Air  
Conditioner .....5  
Care and Maintenance .....8

Troubleshooting Tips

**Installation Instructions**

Features and  
Installation Hardware .....9  
Installation Instructions.....10

**Troubleshooting tips**

Before You  
Call for Service.....12

**FOR YOUR RECORDS**

Write the model and serial numbers here:

**Model #**

**Serial #**

You can find them on a label on the side of each unit.

**Dealer's Name**

**Date Purchased**

**READ THIS MANUAL**

Inside you will find many helpful hints on how to use and maintain your air conditioner properly. Just a little preventive care on your part can save you a great deal of time and money over the life of your air conditioner.

You'll find many answers to common problems in the chart of troubleshooting tips. If you review our chart of **Troubleshooting Tips** first, you may not need to call for service at all.

**CAUTION**

- Contact the authorized service technician for repair or maintenance of this unit.
- Contact the installer for installation of this unit.
- The air conditioner is not intended for use by young children or infirm persons without supervision.
- Young children should be supervised to ensure that they do not play with the air conditioner.



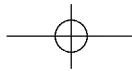

# Safety Precautions

To prevent injury to the user or other people and property damage, the following instructions must be followed.

■ Incorrect operation due to ignoring of instruction will cause harm or damage, the seriousness is classified by the following indications.

	<b>WARNING</b> : This symbol shows the possibility of causing death or serious injury.
	<b>CAUTION</b> : This symbol indicates the possibility of injury or damage to properties only.

■ The items to be followed are classified by the following symbols.

	<b>Never Do This</b>
	<b>Always Do This</b>

## WARNING



- Otherwise, it will cause electric shock or fire due to heat generation or electrical shock.
- It will cause electrical shock or fire due to heat generation.
- It will cause electrical shock or fire.  
• If the supply cord is damaged, it must be replaced by a special cord or assembly available from the manufacturer or its service agent.

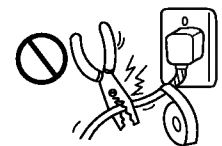
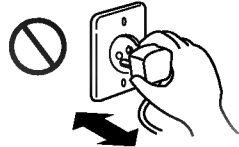
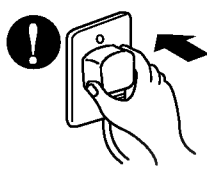

- It will cause electrical shock or fire due to heat generation.
- It may cause electrical shock.
- This could damage your health.

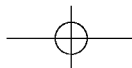
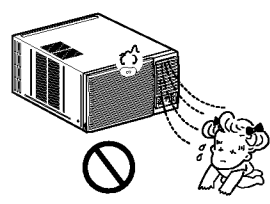

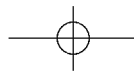

# CAUTION

• It may cause an injury.

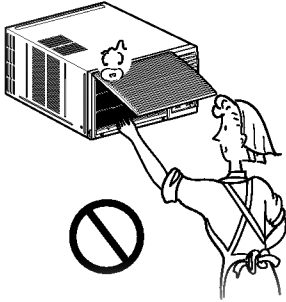

• Water may enter the unit and degrade the insulation. It may cause an electric shock.

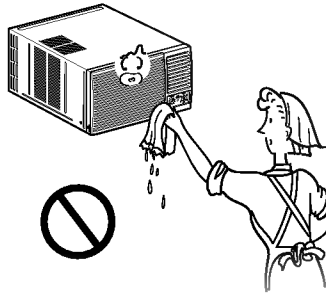

• An oxygen shortage may occur.

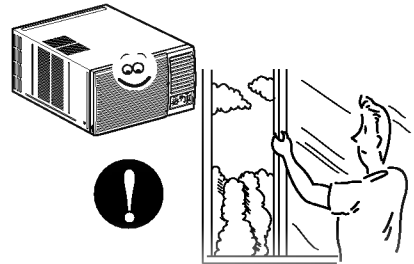

• Since the fan rotates at high speed during operation, it may cause an injury.

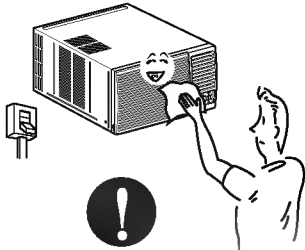

• This could injure the pet or plant.

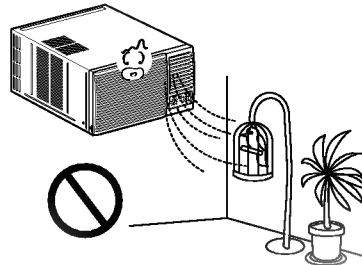

• Do not use this air conditioner to preserve precision devices, food, pets, plants, and art objects. It may cause deterioration of quality, etc.

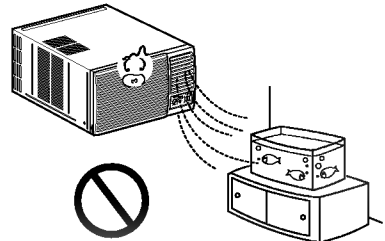

• It may cause an electric shock.

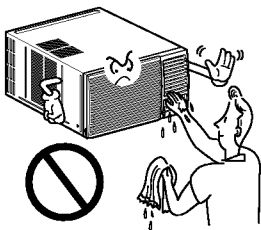

• It may cause a fire or deformation of the cabinet.

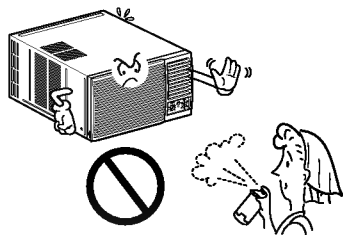

• It may cause imperfect combustion.

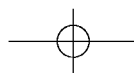
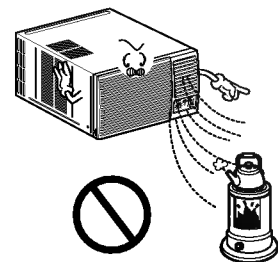

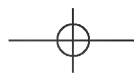

## About the Controls on the air conditioner

### • CAUTION

When the air conditioner has been performing its cooling operation and is turned off or set to the fan position, wait at least 3 minutes before resetting to the cooling operation again.

## FUNCTION

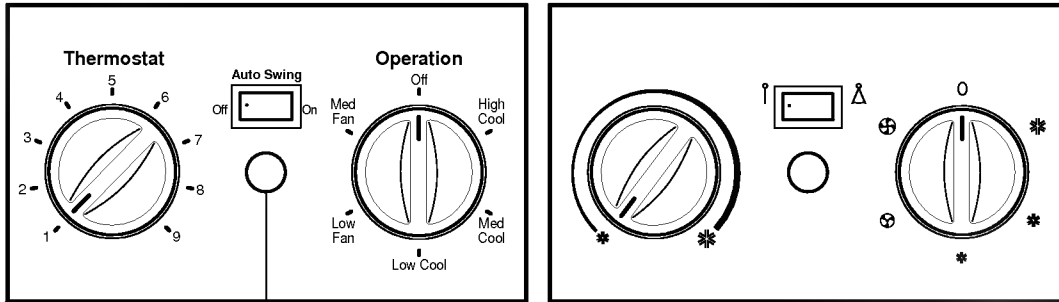

### • THERMOSTAT

Thermostat will automatically control the temperature of the room. Select higher number for lower room temperature. The temperature is selected by turning the knob to the desired position. The 5 or 6 position is a normal setting for average conditions.

Lamp is lighted while OPERATION knob is set to the COOL position.

### • AUTO SWING

ON (  $\Delta$  ) : Air swing is operated while OPERATION knob is set to the COOL position.

OFF (  $\uparrow$  ) : Stops the operation of air swing.

### • OPERATION

OFF ( 0 ) : Turns the air conditioner off.

MED FAN (  $\oplus$  ) : Permits the med fan speed operation without cooling.

LOW FAN (  $\otimes$  ) : Permits the low fan speed operation without cooling.

HIGH COOL (  $\ast$  ) : Permits cooling with the high fan speed operation.

MED COOL (  $\ast$  ) : Permits cooling with the med fan speed operation.

LOW COOL (  $\ast$  ) : Permits cooling with the low fan speed operation.





• **CAUTION**

When the air conditioner has been performing its cooling operation and is turned off or set to the fan position, wait at least 3 minutes before resetting to the cooling operation again.

## How to Insert the Batteries

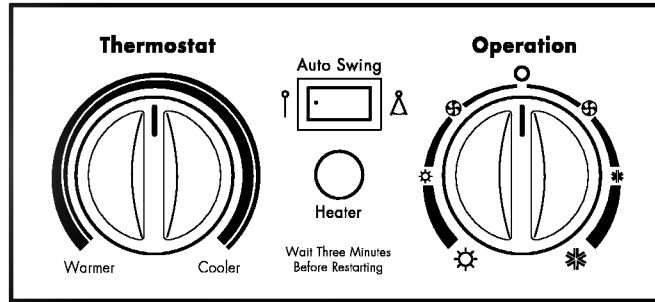

• **THERMOSTAT**

Turn the thermostat control to the desired setting. The control position is a normal setting for average conditions. You can change this setting, if necessary, in accordance with your temperature preference.

The thermostat automatically controls cooling or heating, but the fan runs continuously whenever the air conditioner is in operation. If the room is too warm, turn the thermostat control clockwise. If the room is too cool, turn the thermostat control counterclockwise.

• **HEATER LAMP**

When the unit sets heating operation condition, the green lamp is lighted. When the frost settles on the heat exchanger of the outside, defrosting is made automatically and the green lamp is turned off. The unit may give a hiss and the fan motor stops for 1 to 10 minutes. This should not be regarded as a problem. After defrosting, the heating operation begins again.

• **OPERATION**

- OFF ( ○ ) : Turns the air conditioner off.
- LOW FAN ( ⊕ ) : Permits the low fan speed operation without cooling (heating).
- LOW COOL ( \* ) : Permits cooling with the low fan speed operation.
- HIGH COOL ( ✱ ) : Permits cooling with the high fan speed operation.
- LOW HEAT ( ☆ ) : Permits heating with the low fan speed operation.
- HIGH HEAT ( ⚙ ) : Permits heating with the high fan speed operation.

• **AUTO SWING**

- ON ( ⚙ ) : Air swing is operated while OPERATION knob is set to the COOL or HEAT position.
- OFF ( ↑ ) : Stops the operation of air swing.





## VENTILATION

The ventilation lever must be in the CLOSE position in order to maintain the best cooling conditions. When fresh air is necessary in the room, set the ventilation lever to the OPEN position. The damper is opened and room air is exhausted.

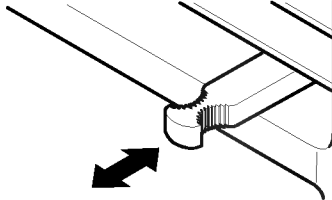

CLOSE  VENT  OPEN

## TO CONTROL AIR DIRECTION

The direction of air can be controlled wherever you want to cool by adjusting the horizontal louver and the vertical louver.

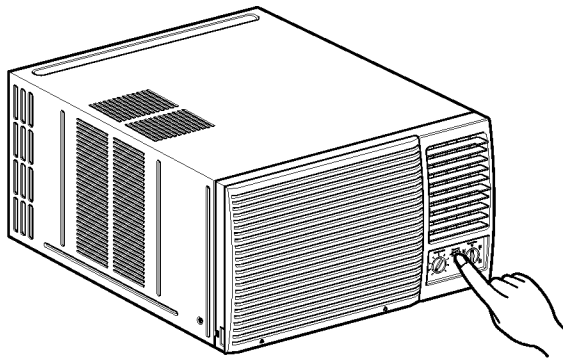

### HORIZONTAL AIR-DIRECTION CONTROL

To control horizontal direction of air flow, set to the ON position the auto swing switch and the air flow will be swept horizontally by the automatic air-swing system.

If you want to stop the air flow from moving, switch off the auto swing switch at the desired position of the vane.

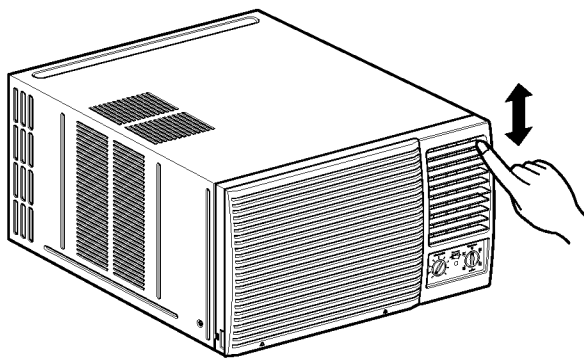

### VERTICAL AIR-DIRECTION CONTROL

The vertical auto direction is adjusted by moving the horizontal louver.



## Care and maintenance

### Grille and Case

Turn the air conditioner off and remove the plug from the wall outlet before cleaning.

To clean, use water and a mild detergent. Do not use bleach or abrasives.

### Outdoor Coils

The coils on the outdoor side of the air conditioner should be checked regularly. If they are clogged with dirt or soot they may be professionally steam cleaned, a service available through a dealer.

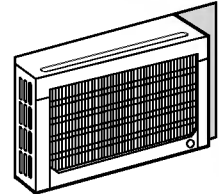

### Air Filter

The air filter behind the front grille should be checked and cleaned at least once every 2 weeks or more often if necessary. The grille is designed to clean the filter both upward and downward.

#### To remove:

- 1 Open the inlet grille upward by pulling out the bottom of the inlet grille or downward by pulling out the top of the inlet grille.
- 2 Using the tab, pull up slightly on the filter to release it and pull it down or up.
- 3 Clean the filter with warm, soapy water below 40°C (104°F).
- 4 Rinse and gently shake the water from the filter and let it dry before replacing it.

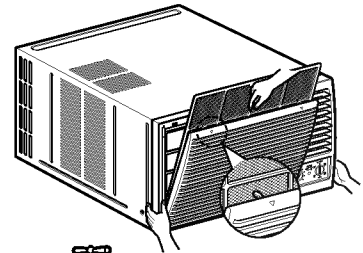
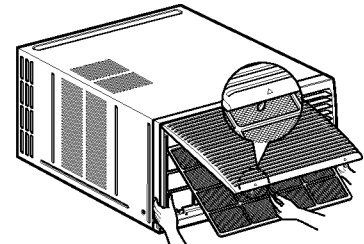

**CAUTION:** DO NOT operate the air conditioner without a filter because dirt and lint will clog it and reduce performance.

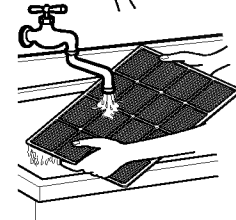

### Drainage

- 1 In humid weather, excess water may cause the BASE PAN to overflow.
  1. When the rear hole of the BASE PAN is open, connect the drain pipe.
  2. When the rear hole of the BASE PAN is capped with HOLE RUBBER, replace with the DRAIN PIPE if you need to drain.
- 2 In very humid area, you can install the drain pan as below.
  1. Take the drain pan which is located in the air discharge.
  2. Remove the hole rubber from the base-pan. (for some models).
  3. Install the drain pan to the right corner of the cabinet with screws.

Connect the drain hose to the outlet located at the DRAIN PIPE or the bottom of the drain pan.

You can purchase the drain hose or tubing locally to satisfy your particular needs. (Drain hose is not supplied).

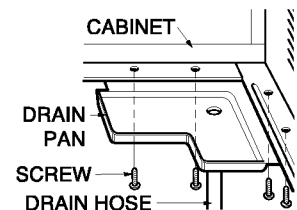
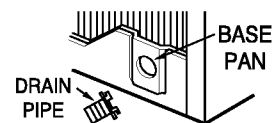





# Features and Installation Hardware

Learning parts name prior to installation will help you understanding the installation procedure.

## Features

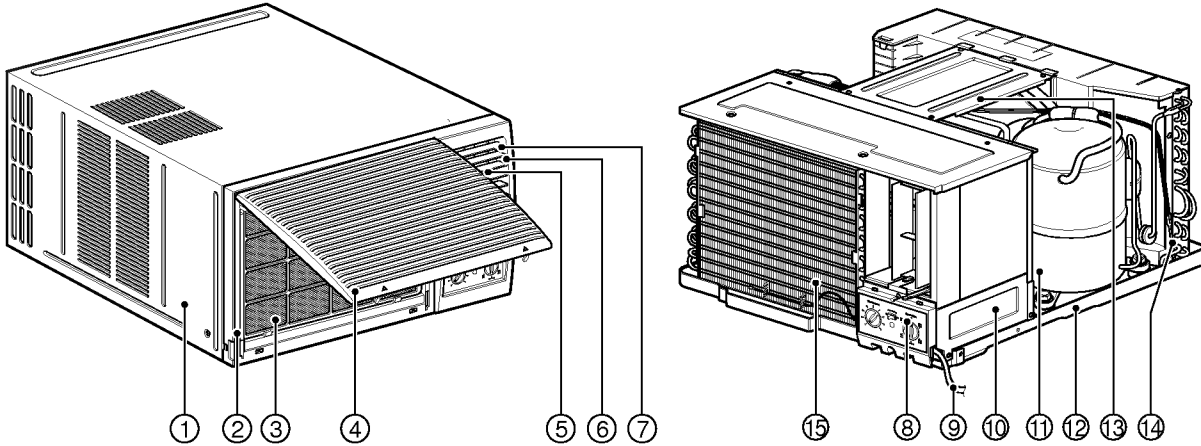

- |   |  |
|---|--|
| <ul style="list-style-type: none"> <li>1. CABINET</li> <li>2. FRONT GRILLE</li> <li>3. AIR FILTER</li> <li>4. AIR INTAKE(INLET GRILLE)</li> <li>5. AIR DISCHARGE</li> <li>6. VERTICAL AIR DEFLECTOR (HORIZONTAL LOUVER)</li> <li>7. HORIZONTAL AIR DEFLECTOR (VERTICAL LOUVER)</li> </ul> | <ul style="list-style-type: none"> <li>8. CONTROL PANEL</li> <li>9. POWER CORD</li> <li>10. COVER CONTROL</li> <li>11. COMPRESSOR</li> <li>12. BASE PAN</li> <li>13. BRACE</li> <li>14. CONDENSER</li> <li>15. EVAPORATOR</li> <li>16. REMOTE CONTROL</li> </ul> |
|---|--|

## Installation Hardware

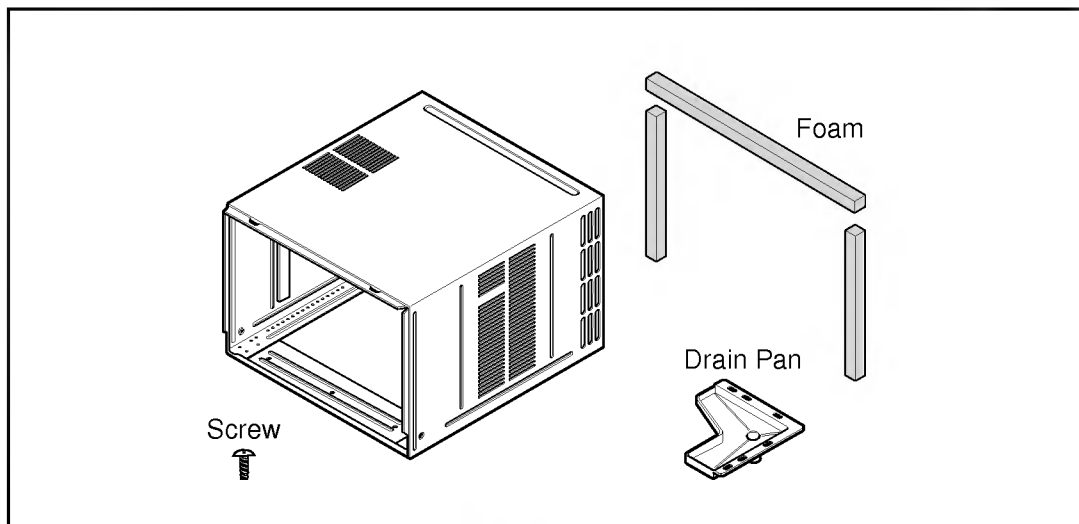

## Installation Instructions

Read completely, then follow step-by step.

- The appliance shall be installed in accordance with national wiring regulation.
- If a power plug isn't to be used, provide a circuit breaker between power source and the unit, as following picture.

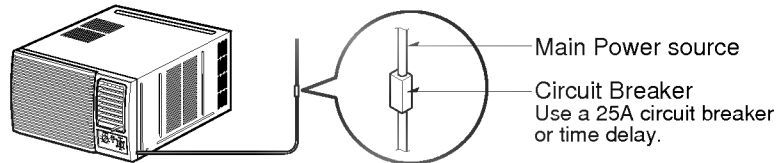

### Select the Best Location

- A** To prevent vibration and noise, make sure the unit is installed securely and firmly.
- B** Install the unit where the sunlight does not shine directly on the unit.
- C** There should be no obstacle, such as a fence or wall, within 50cm from the back of the cabinet because it will prevent heat radiation of the condenser. Restriction of outside air will greatly reduce the cooling efficiency of the air conditioner.
- D** Install the unit a little obliquely outward not to leak the condensed water into the room (about 10 ~ 15mm or 1/4 bubble with level).

**CAUTION:** All side louvers of the cabinet must remain exposed to the outside of the structure.

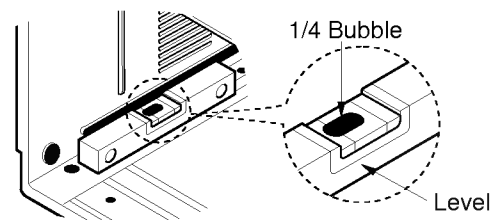
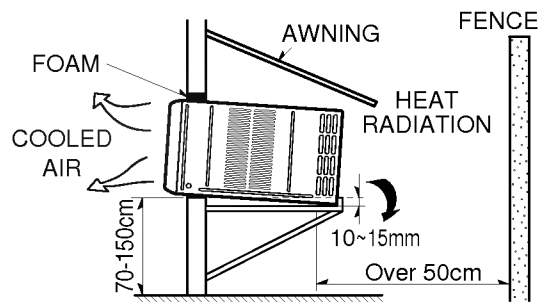

### Remove the Air Conditioner From the Case

- A** Remove the 2 shipping screws from the back of the case.
- B** Remove the 2 screws on each side of the case. Keep these for later use.
- C** Slide the air conditioner from the case by gripping the base pan handle and pulling forward while bracing the case.

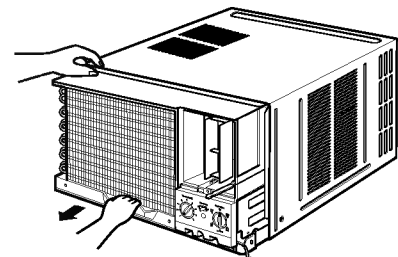
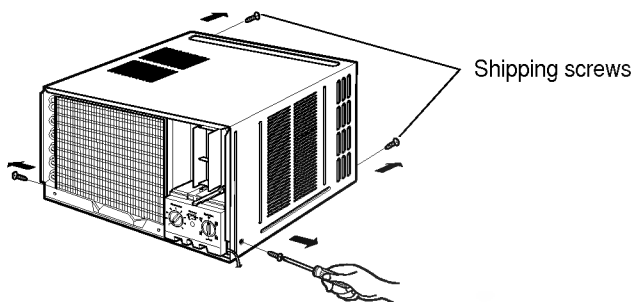

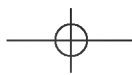

## Install the Air Conditioner in the Case

- A** Slide the air conditioner into the case. Reinstall the 2 screws removed earlier on each side of the case.

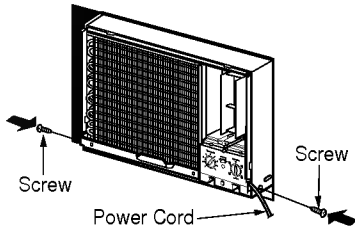

**CAUTION:** The power cord must be connected to an independent circuit. The green wire must be grounded.

- B** Stuff the foam between the top of the unit and the wall to prevent air and insects from getting into the room.

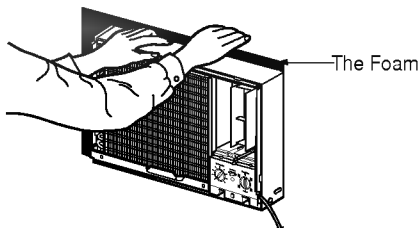

- C** Before installing the front grille, pull out the vent control lever located above the unit control knobs, as shown.

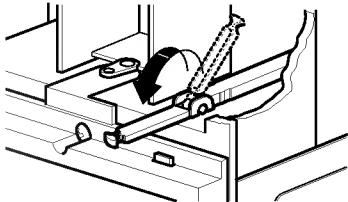

- D** Attach the front grille to the case by inserting the tabs on the grille into the slots on the front of the case. Push the grille in until it snaps into place.

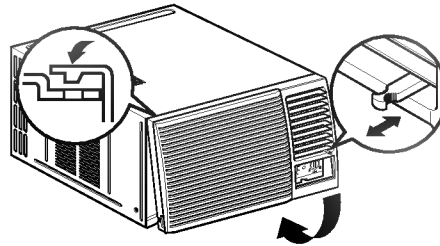

When you detach the front grille from the case, push the grille to your rightside and pull it toward you.

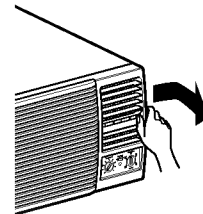

- E** Lift the inlet grille and secure the front grille with a screw. Lower the inlet grille into place.

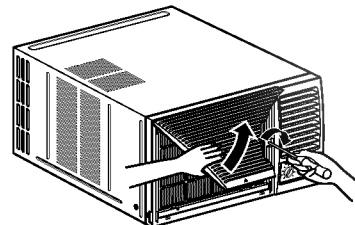

## Use the Reversible Inlet Grille

- A** If you want to pull out the filter upward, open the inlet grille slightly. Turn inside out the front grille. Disassemble the inlet grille from the front grille with separating the hinged part by inserting a "—" type screw-driver tip. Rotate the inlet grille 180 degrees and insert the hooks into the lower holes of front grille. Then, insert the filter

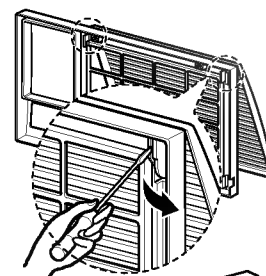

- B** If you want to pull out the filter downward, use the reversible inlet grille without change. (The grille is already assembled for that way.)

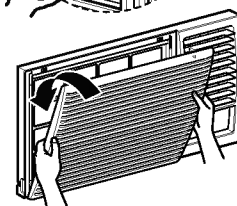

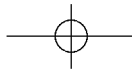

# Before you call for service...

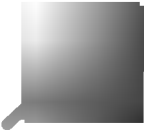

*Troubleshooting Tips*  
 Save time and money! Review the chart below first and you may not need to call for service.

## Normal Operation

- You may hear a pinging noise caused by water being picked up and thrown against the condenser on rainy days or when the humidity is high. This design feature helps remove moisture and improve efficiency.
- You may hear the thermostat click when the compressor cycles on and off.
- Water will collect in the base pan during high humidity or on rainy days. The water may overflow and drip from the outdoor side of the unit.
- The fan may run even when the compressor does not.

## Abnormal Operation

<b>Air conditioner does not start</b>	■ <i>The air conditioner is unplugged.</i>	• Make sure the air conditioner plug is pushed completely into the outlet.
	■ <i>The fuse is blown/circuit breaker is tripped.</i>	• Check the house fuse/circuit breaker box and replace the fuse or reset the breaker.
	■ <i>Power failure.</i>	• If power failure occurs, turn the mode control to <b>OFF</b> . When power is restored, wait 3 minutes to restart the air conditioner to prevent tripping of the compressor overload.
<b>Air conditioner does not cool as it should</b>	■ <i>Airflow is restricted.</i>	• Make sure there are no curtains, blinds, or furniture blocking the front of the air conditioner.
	■ <i>The THERMOSTAT may not be set high enough.</i>	• Turn the knob to a higher setting. The highest setting provides maximum cooling.
	■ <i>The air filter is dirty.</i>	• Clean the filter at least every 2 weeks. See the operating instructions section.
	■ <i>The room may have been hot.</i>	• When the air conditioner is first turned on you need to allow time for the room to cool down.
	■ <i>Cold air is escaping.</i>	• Check for open furnace floor registers and cold air returns. • Set the air conditioner's vent to the closed position.
<b>Air conditioner freezing up</b>	■ <i>Cooling coils have iced up.</i>	• See Air Conditioner Freezing Up below.
	■ <i>Ice blocks the air flow and stops the air conditioner from cooling the room.</i>	• Set the mode control at HIGH fan or HIGH cool with the high temperature.

