

SEARS

**USE & CARE
MANUAL**

**MODEL No.
85240
85249**

KNOW YOUR UNIT

Read this booklet so you will be able to enjoy all the features in your Kenmore Microwave Oven.

Record in the space provided below the Model No. and the Serial No. of the appliance.

Model No. _____

Serial No. _____

Retain this information for future reference.

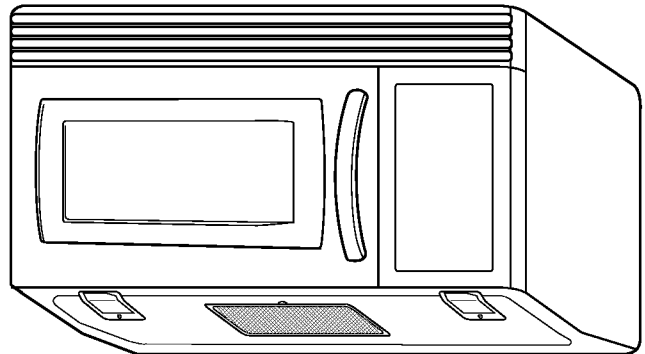

MICROWAVE OVEN



Use and Care Manual

*Sold by Sears Canada Inc.

Part No. 3828W5A2915

SEARS. CANADA INC., TORONTO. M5B 2B8

TABLE OF CONTENTS

TABLE OF CONTENTS	2	SENSOR OPERATING INSTRUCTIONS	14
SAFETY	3	Sensor Cooking Guide	14
Important Safety Instructions	3	Adding or Subtracting Cook time	15
Precautions To Avoid Possible Exposure To Excessive Microwave Energy	4	Popcorn.....	15
INFORMATION	5	Vegetable.....	15
Location of Model Number	5	Pizza	15
Oven Specifications	5	Potato.....	16
Electrical Rating	5	Cook.....	16
Electrical Requirements	5	Reheat	16
Grounding Instructions	5	QUICK DEFROST	17
Microwave Oven Features	6	EXPRESS DEFROST	17
Oven Control Panel.....	7	EXPRESS DEFROST CHART	18
OPERATION	9	USE OF THE TWO POSITION METAL RACK ...20	
LEARN ABOUT YOUR MICROWAVE OVEN	9	MAINTENANCE	21
Time of Day.....	9	CARE AND CLEANING	21
Kitchen Timer	9	Metal Rack	21
Light Timer	9	Cleaning the Grease Filters	21
 Hi/Low/Off	10	Charcoal Filter(Optional) Replacement	21
 Hi/Low/Off	10	Cooktop/Night Light Replacement	22
 On/Off	10	Oven Light Replacement	22
Child Lock	10	QUESTIONS AND ANSWERS	22
Help.....	10	MICROWAVE UTENSIL GUIDE	23
Hold Warm	10	BEFORE CALLING FOR SERVICE	24
Custom Set	11	SEARS SERVICE	27
Quick Touch Plus.....	11	SEARS WARRANTY	28
Custom Cook	11	SERVICE AND REPAIR PARTS	29
More / Less	12		
Cooking at High Cook Power	12		
Cooking at Lower Power Levels.....	12		
Cooking Guide for "Lower Power Levels"	13		

SAFETY

IMPORTANT SAFETY INSTRUCTIONS

The safety instructions below will tell you how to use your oven to avoid harm to yourself or damage to your oven.

WARNING-To reduce the risk of burns, electric shock, fire, injury to persons or exposure to excessive microwave energy.

- **Read all the instructions before using your oven.**
- **Do not allow children to use this oven without close supervision.**
- Read and follow the specific “**PRECAUTIONS TO AVOID POSSIBLE EXPOSURE TO EXCESSIVE MICROWAVE ENERGY**” found on page 4.
- Use the microwave oven only for its intended use as described in its manual. **Do not use** corrosive chemicals or vapors, in the microwave oven. This type of oven is specifically designed to heat, cook or dry food. It is not designed for industrial or laboratory use.
- **Do not use or store** this appliance outdoors. Do not use this product near water -for example, near a kitchen sink, in a wet basement, or near a swimming pool, and the like.
- **Do not use** the cavity for storage purposes. Do not leave paper products, cooking utensils, or food in the cavity when not in use.
- **Clean the ventilating hood frequently.** Do not allow grease to accumulate on the hood or the filters.
- When flaming foods under the hood, turn the fan on.
- Suitable for use above both gas and electric cooking equipment 36 inches wide or less.
- Use care when cleaning the vent hood filters. Corrosive cleaning agents such as lye-based oven cleaners, may damage the filters.
- **When cleaning the door and the surfaces that touch the door, use only mild, non-abrasive soaps or detergents and a sponge or soft cloth.**
- **Do not tamper with the built-in safety switches on the oven door.** The oven has several built-in safety switches to make sure the power is off when the door is open.
- **If your oven is dropped or damaged,** have it thoroughly checked by a qualified service technician before using it again.
- **To avoid a fire hazard:**
 - **Do not severely overcook food.** Severely overcooked foods can start a fire in the oven. Watch the oven carefully, especially if you have paper, plastic, or other combustibles in the oven.
 - **Do not store combustible items (bread, cookies, etc.) in the oven,** because if lightning strikes the power lines, it may cause the oven to turn on.
 - **Do not use wire twist-ties in the oven.** Be sure to remove them before placing the item in the oven.
- **If a fire should start:**
 - **Keep the oven door closed.**
 - **Turn the oven off.**
 - **Disconnect the power cord or shut off the power at the fuse or circuit breaker panel.**
- **To avoid electric shock:**
 - **This appliance must be grounded.** Connect it only to a properly grounded outlet. See the electrical grounding instructions on page 5.
 - **Do not operate this appliance if it has a damaged cord or plug,** if it is not working properly or if it has been damaged or dropped.
 - **Do not immerse the electrical cord or plug in water.**
 - **Keep the cord away from heated surfaces.**
 - This appliance should be serviced only by qualified service personnel.
- Install or locate the microwave oven only in accordance with the provided installation instructions.
- Do not mount oven a sink.
- Do not let cord hang over edge of table or counter.

SAFETY

- **To avoid improperly cooking some foods.**
 - **Do not heat any types of baby bottles or baby food.** Uneven heating may occur and possibly cause personal injury.
 - **Do not heat small-necked containers,** such as syrup bottles.
 - **Do not deep-fat fry in your microwave oven.**
 - **Do not attempt home canning in your microwave oven.**
 - **Do not heat the following items in the microwave oven:** whole eggs in the shell; water with oil or fat; sealed containers or closed glass jars. These items may explode.
- **Do not use this oven for commercial purposes.** It is made for household use only.
- Do not cover or block any openings in the oven.
- Do not run the oven empty, without food in it.
 - **Do not** allow the gray film on special microwave-cooking packages to touch the oven floor. Put the package on a microwavable dish.
- **Do not** cook anything directly on the oven floor. Use a microwavable dish.
- Keep a browning dish at least 3/16 inch above floor. Carefully read and follow the instructions for the browning dish. If you use a browning dish incorrectly, you could damage the oven floor.
- **Preserve the metal rack:**
 - Remove the metal rack from the oven when you are not using it.
 - **Do not** use the oven empty with the metal rack in it.
 - The metal rack may get hot while cooking. Use pot holders to remove it after cooking.
 - **Do not** use foil or metal containers on the metal rack.
- This appliance should be serviced only by qualified service personnel. Contact nearest authorized service facility for examination, repair or adjustment.

SAVE THESE INSTRUCTIONS

PRECAUTIONS TO AVOID POSSIBLE EXPOSURE TO EXCESSIVE MICROWAVE ENERGY ...

- **Do not attempt to operate this oven with the door open,** since open-door operation can result in harmful exposure to microwave energy. It is important not to defeat or tamper with the safety interlock.
- **Do not operate the oven if it is damaged.** It is particularly important that the oven door close properly and that there is no damage to the:
 - door (bent)
 - hinges and latches (broken or loosened)
 - door seals and sealing surfaces.
- **Do not place any object between the oven front face and the door,** or allow soil or cleaner residue to accumulate on sealing surfaces.
- **The oven should not be adjusted or repaired** by anyone except properly qualified service personnel.

INFORMATION

Please read this owner's manual. It will tell you how to use all the fine features of this microwave oven.

LOCATION OF MODEL NUMBER

To request service information or replacement parts, SEARS CANADA will require the complete model number of your microwave oven. The number is on the left side of control panel as shown in the illustration below.

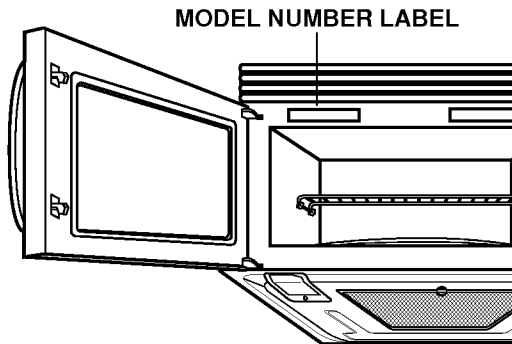

OVEN SPECIFICATIONS

Output Power 1050W (IEC 60705 Standard)
 Outer Dimensions 29-15/16" x 16-7/16" x 15-5/8"
 Cavity Volume 1.9 Cu.ft
 Net Weight 60 lbs.

ELECTRICAL RATING

* Electrical Rating of the Oven: 120V AC 60Hz
 * 13 Amps / 1500 Watts (MWO + Cooktop Lamp + Ventilation Fan)

ELECTRICAL REQUIREMENTS

The oven is designed to operate on a Standard 120V/60Hz household outlet. Be sure the circuit is at least 15A or 20A and the microwave oven is the **only appliance on the circuit**. It is not designed for 50Hz or any circuit other than a 120V/60Hz circuit.

GROUNDING INSTRUCTIONS

This appliance must be grounded. If an electrical short circuit occurs, grounding reduces the risk of electric shock by providing an escape wire for the electric current. The cord for this appliance has a grounding wire with a grounding plug. Put the plug into an outlet that is properly installed and grounded.

WARNING - If you use the grounding plug improperly, you risk electric shock.

Ask a qualified electrician if you do not understand the grounding instructions or if you wonder whether the appliance is properly grounded.

Because this appliance fits under the cabinet, it has a short power-supply cord. See the separate Installation Instructions for directions on properly placing the cord. Keep the electrical power cord dry and do not pinch or crush it in any way.

If it is necessary to use an extension cord, use only a 3-wire extension cord that has a 3-blade grounding plug, and a 3-slot receptacle that will accept the plug on the appliance. The marked rating of the extension cord shall be equal to or greater than the electrical rating of the appliance.

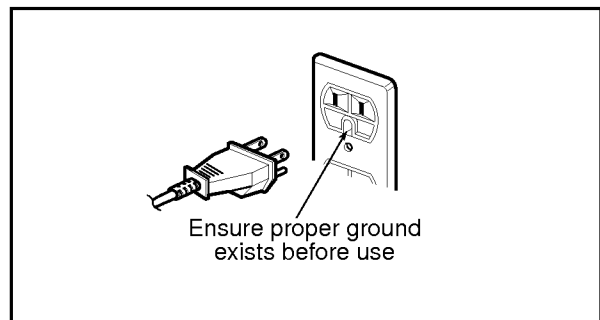

For a permanently connected appliance:
 This appliance must be connected to a grounded, metallic, permanent wiring system, or an equipment grounding conductor should be run with the circuit conductors and connected to the equipment grounding terminal or lead on the appliance.

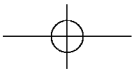

INFORMATION

MICROWAVE OVEN FEATURES

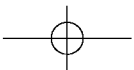
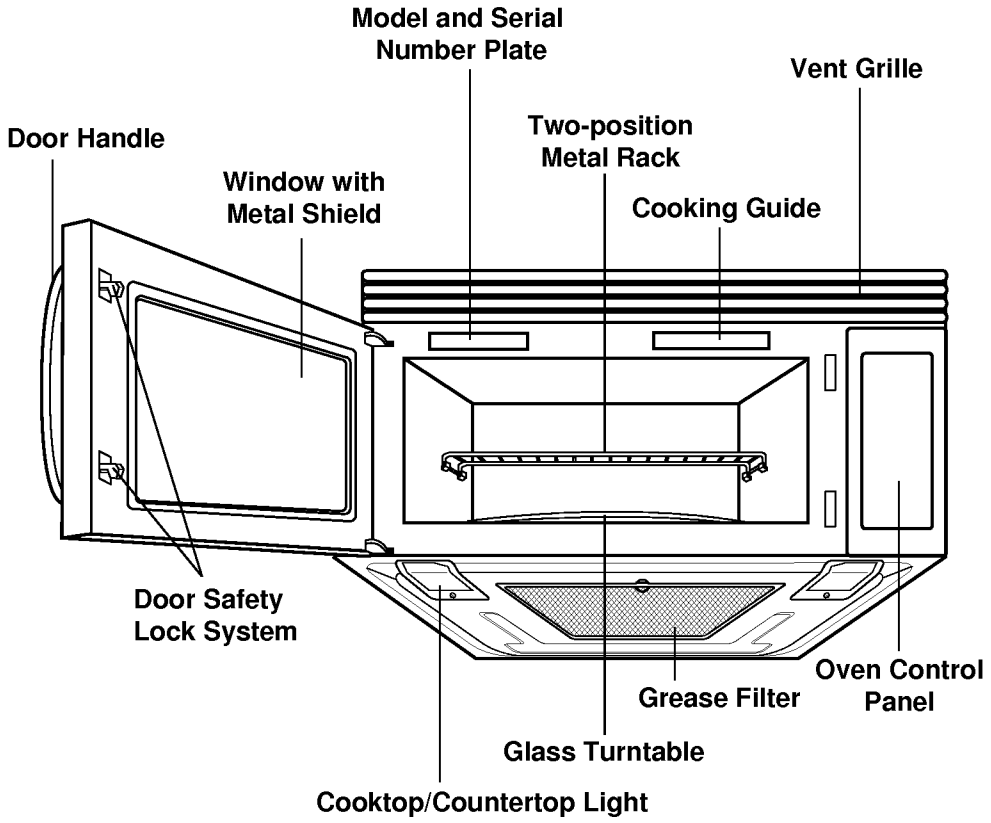

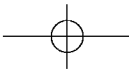

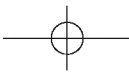
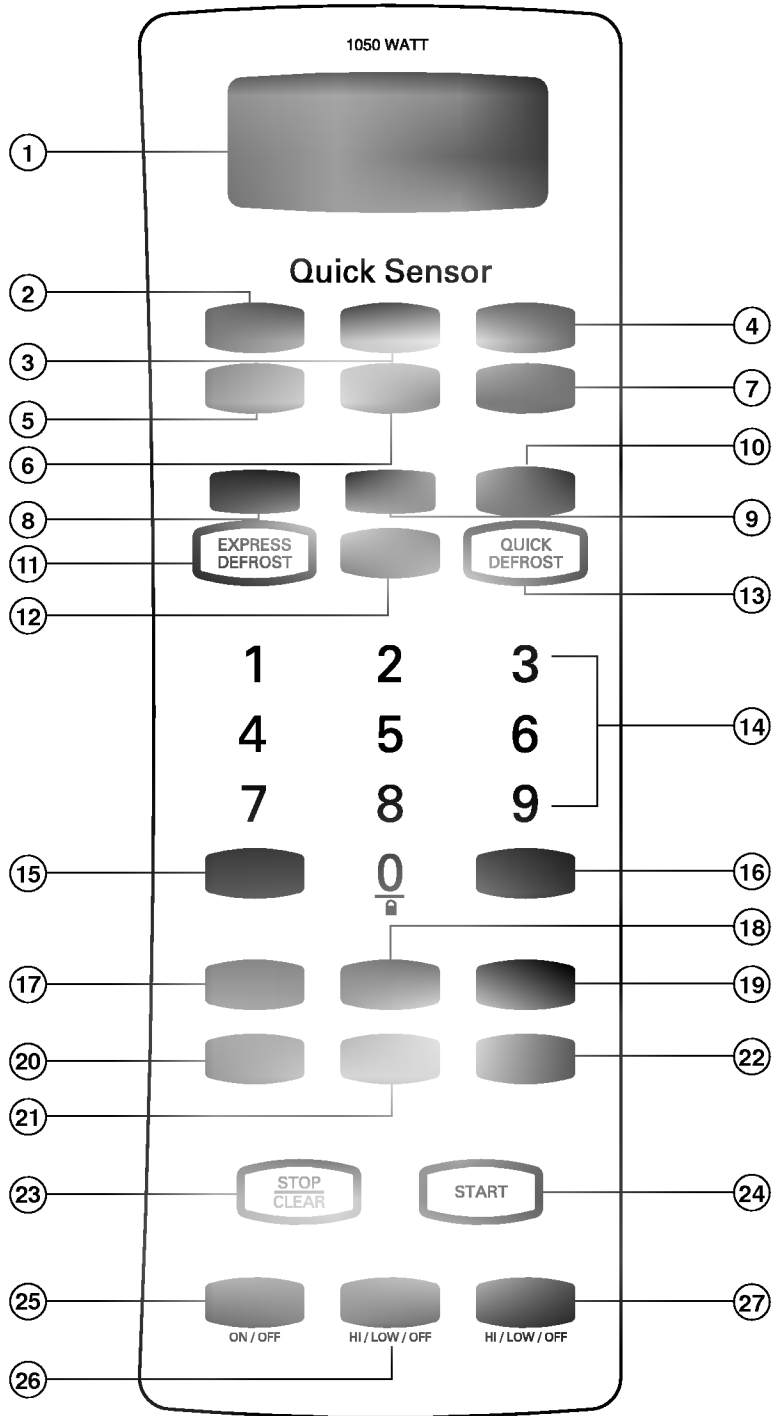

INFORMATION

OVEN CONTROL PANEL



INFORMATION

1. **DISPLAY:** The Display includes a clock and indicators to tell you time of day, cooking time settings and cooking functions selected.
2. **POPCORN:** Touch this pad when popping popcorn in your microwave oven. The oven's sensor will tell the oven how long to cook depending on the amount of humidity it detects from the popcorn.
3. **COOK:** Touch this pad to cook frozen entree, casserole, and rice. The oven's sensor will tell the oven how long to cook depending on the amount of humidity it detects from the popcorn.
4. **PIZZA:** Touch this pad to cook pizza without selecting cooking times and power levels.
5. **POTATO:** Touch this pad to cook potatoes. The oven's sensor will tell the oven how long to cook depending on the amount of humidity it detects from the potato.
6. **REHEAT:** Touch this pad to reheat casserole, dinner plate, and soup/sauce. The oven's sensor will tell the oven how long to cook depending on the amount of humidity it detects from the popcorn.
7. **VEGETABLE:** Touch this pad to reheat vegetables. The oven's sensor will tell the oven how long to cook depending on the amount of humidity it detects from the vegetables.
8. **MORE:** Touch this pad to add ten seconds of cooking time each time you press it.
9. **LESS:** Touch this pad to subtract ten seconds of cooking time each time you press it.
10. **HELP:** Touch this pad to learn how to use each oven function.
11. **EXPRESS DEFROST:** Meat, poultry, fish. Touch on pad to select food type and defrost food by weight.
12. **QUICK TOUCH PLUS:** Touch this pad to set and start quickly at 100% power.
13. **QUICK DEFROST:** This pad provides you with the quick defrosting method for 1.0 pounds frozen foods.
14. **NUMBER:** Touch number pads to enter cooking time, power level, quantities or weights.
15. **TIME:** Touch this pad to set a cooking time.
16. **POWER:** Touch this pad to select a cooking power level.
17. **CUSTOM SET:** Touch this pad to change the oven's default settings for sound, clock, display speed and defrost weight.
18. **HOLD WARM:** Touch this pad to keep hot, cooked foods safety warm in your microwave oven for up to 99 minutes 99 seconds.
19. **TIME OF DAY:** Touch this pad to enter the time of day.
20. **CUSTOM COOK:** Touch this pad to recall one cooking instruction previously programmed into memory.
21. **LIGHT TIMER:** Touch this pad to set the light timer.
22. **KITCHEN TIMER:** Touch this pad to set the kitchen timer.
23. **STOP/CLEAR:** Touch this pad to stop the oven or clear all entries.
24. **START:** Touch this pad to start a function. If you open the door after oven begins to cook, retouch START.
25.  **ON/OFF:** Touch this pad to turn off the turntable. "OFF" will appear in the display.
26.  **HI/LOW/OFF:** Touch this pad to turn the fan on or off.
27.  **HI/LOW/OFF:** Touch this pad to turn on the cooktop/countertop light.

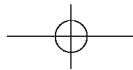



LEARN ABOUT YOUR MICROWAVE OVEN

This section discusses the concepts behind microwave cooking and introduces you to the basics you need to know to operate your microwave oven. Please read this information before use.

TIME OF DAY

This oven includes a 24 hour clock.



Example: To set 8:00 AM.

1. Touch **STOP/CLEAR**.

2. Touch **TIME OF DAY**.
(Press once for AM, twice for PM.)

3. Enter the time by using the number key pad.
8 0 0
4. Touch **TIME OF DAY**.
(or **START**)

KITCHEN TIMER

You can use your microwave oven as a timer. Use the Timer for timing up to 99 minutes, 99 seconds.





Example: To count 3 minutes.

1. Touch **STOP/CLEAR**.

2. Touch **KITCHEN TIMER**.

3. Enter the time by using the number key pad.
3 0 0
4. Touch **START**.
When the time is over, you will hear seven beeps and **END** will display.

LIGHT TIMER



You can set the LIGHT to turn on and off automatically at any time you want. The light comes on at the same time every day until reset.

Example: Turn on 2:00 AM, turn off 7:00 AM.

1. Touch **STOP/CLEAR**.

2. Touch **LIGHT TIMER**.
(Press once for AM, twice for PM.)

3. Enter the time you want the LIGHT to turn on.
2 0 0
4. Touch **LIGHT TIMER** again.
(Press once for AM, twice for PM.)

5. Enter the time you want the LIGHT to turn off.
7 0 0
6. Touch **START**.

NOTE: To reset that time to turn on and off the LIGHT, repeat steps 2 to 6.

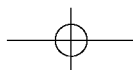
Example: To cancel the LIGHT TIMER.

1. Touch **LIGHT TIMER**.

2. Touch **STOP/CLEAR**.

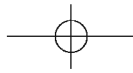

NOTE: If you want to cancel the LIGHT TIMER in operation, you should touch  key.





HI / LOW / OFF



The FAN moves steam and other vapors from the surface cooking. Touch  once for High fan speed, twice for Low fan speed, or a three times to turn the fan off.

NOTE: If the temperature gets too hot around the microwave oven, the fan in the vent hood will automatically turn on at the LOW setting to cool the oven. It may stay on up to an hour to cool the oven. When this occurs, **you can not turn the fan off manually.**

HI / LOW / OFF



Touch  once for bright light, twice for the night light or three times to turn the light off.

ON / OFF



For best cooking results, leave the turntable on. It can be turned off for large dishes. Press  to turn the turntable on or off.

NOTE:

- Sometimes the turntable can become hot to touch. Be careful touching the turntable during and after cooking.
- Do not run the empty without food in it.

CHILD LOCK

You may lock the control panel to prevent the microwave from being accidentally started or used by children.

Example: To set the child lock.



1. Touch **STOP/CLEAR**.



2. Touch and hold **0** more than 4 seconds. **LOCKED** will appear in the display window with two beeps.



1. Touch and hold **0** more than 4 seconds. **LOCKED** will disappear and you hear two beeps. At this time the oven is ready.

Example: To cancel the child lock.

HELP

The HELP pad display feature information and helpful hints. Press HELP, then select a key pad.

Example: To learn about POPCORN.



1. Touch **STOP/CLEAR**.



2. Touch **HELP**.



3. Touch **POPCORN**.

HOLD WARM

You can safely keep hot, cooked food warm in your microwave oven for up to 99 minutes 99 seconds. You can use HOLD WARM by itself, or to automatically follow a cooking cycle.

Example: To use the hold warm.



1. Touch **STOP/CLEAR**.



2. Touch **HOLD WARM**.



3. Touch **START**.

NOTES:

- HOLD WARM operates for up to 99 minutes 99 seconds.
- Food cooked covered should be covered during HOLD WARM.
- Pastry items (pies, turnovers, etc.) should be uncovered during HOLD WARM.
- Complete meals kept warm on a dinner plate could be covered during HOLD WARM.

To make HOLD WARM automatically follow another cycle:

- While you are programming the cooking instructions, touch HOLD WARM before touching START.
- When the last cooking cycle is over, you will hear two tones and "WARM" will appear in the oven display.
- You can set HOLD WARM to follow EXPRESS DEFROST, or multi-cycle cooking.

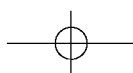

CUSTOM SET

You can change the default values for beep sound, clock, display speed and defrost weight. See following chart for more information.

NUMBER	CUSTOM SET	NUMBER	RESULT
1	Sound ON/OFF control	1	Sound ON
		2	Sound OFF
2	Clock display control	1	Clock ON
		2	Clock OFF
3	Display	1	Slow speed
		2	Normal speed
		3	Fast speed
4	Defrost weight mode select	1	Lbs
		2	Kg

Example: To change defrost weight mode. (from lbs to kg)



1. Touch **STOP/CLEAR**.



2. Touch **CUSTOM SET**.

4

3. Touch number **4**.

2

4. Touch number **2**.

QUICK TOUCH PLUS

A time-saving pad, this simplified control lets you quickly set and start microwave cooking without the need to touch **START**.

Example: To set Quick Touch Plus for 2 minutes.



Touch **Quick Touch Plus** 4 times. The oven begins cooking and display shows time counting down.

NOTE:

If you touch **Quick Touch Plus**, it will add 30 seconds up to 3 minutes ; after 3 minutes every touch will add 1 minutes up to 99 min 59 seconds.

CUSTOM COOK

CUSTOM COOK lets you to recall one cooking instruction previously placed in memory and begin cooking quickly.

Example: To memorize for 2 minutes.



1. Touch **STOP/CLEAR**.



2. Touch **CUSTOM COOK**.

2 0 0

3. Enter the cook time.



4. Touch **START**.

Example: To recall the memory.



1. Touch **STOP/CLEAR**.



2. Touch **CUSTOM COOK**.



3. Touch **START**.

When the cook time is over, you will hear four beeps and **END** will display.

MORE / LESS

By using the MORE or LESS Keys, all of the pre-programmed cook and time cook and etc. can be adjusted to cook food for a longer or shorter time.

Pressing MORE will add 10 seconds of the cooking time each time you press it. Pressing LESS will subtract 10 seconds of cooking time each time you press it.

COOKING AT HIGH COOK POWER

Example: To cook food for 8 minutes 30 seconds.



1. Touch **STOP/CLEAR**.

8 3 0

2. Enter the cook time.



3. Touch **START**.
When the cook time is over, you will hear four beeps and **END** will display.

COOKING AT LOWER POWER LEVELS

HIGH power cooking does not always give you the best results with foods that need slower cooking, such as roasts, baked goods, or custards. Your oven has 9 power settings in addition to "HIGH".

Example: To cook food for 7 minutes 30 seconds at 70% power.



1. Touch **STOP/CLEAR**.

7 3 0

2. Enter the cook time.



3. Touch **POWER**.

7

4. Enter the power level.



5. Touch **START**.
When the cook time is over, you will hear four beeps and **END** will display.

OPERATION

COOKING GUIDE FOR “LOWER POWER LEVELS”

The nine power levels in addition to “HIGH” allow you to choose the best power level for the food you are cooking. Below are listed all the power levels,

examples of foods best cooked at each level, and the amount of microwave power you are using.

POWER LEVEL	MICROWAVE OUTPUT	USE
10 “HIGH”	100%	<ul style="list-style-type: none"> • Boil water. • Cook ground beef. • Make candy. • Cook fresh fruits and vegetables. • Cook fish, and poultry. • Preheat browning dish.
9	90%	<ul style="list-style-type: none"> • Reheat meat slices quickly. • Saute onions, celery, and green pepper.
8	80%	<ul style="list-style-type: none"> • All reheating. • Cook scrambled eggs.
7	70%	<ul style="list-style-type: none"> • Cook breads and cereal products. • Cook cheese dishes, veal. • Cook cakes, muffins, brownies, cup cakes.
6	60%	<ul style="list-style-type: none"> • Cook pasta.
5	50%	<ul style="list-style-type: none"> • Cook meats, whole poultry. • Cook custard. • Cook whole chicken, turkey, spare ribs, rib roast, sirloin roast.
4	40%	<ul style="list-style-type: none"> • Cook less tender cuts of meat. • Reheat frozen convenience foods.
3	30%	<ul style="list-style-type: none"> • Thawing meat, poultry, and seafood. • Cooking small quantities of food. • Finish cooking casserole, stew, and some sauces.
2	20%	<ul style="list-style-type: none"> • Soften butter and cream cheese. • Heating small amounts of food.
1	10%	<ul style="list-style-type: none"> • Soften ice cream. • Raise yeast dough.
0		<ul style="list-style-type: none"> • Standing time.

OPERATION

SENSOR OPERATING INSTRUCTIONS

Sensor Cook allows you to cook most of your favorite foods without selecting cooking times and power levels. The display will indicate "SENSING" during the initial sensing period. The oven automatically determines required cooking time for each food item. When the internal sensor detects a certain amount of humidity coming from the food, it will tell the oven how much longer to heat. The display will show the remaining heating time. For best results by Sensor, following these recommendation.

1. Food cooked with the sensor system should be at normal storage temperature.
2. Glass Tray and outside of container should be dry to assure best cooking results.
3. Foods should always be covered loosely with microwavable plastic wrap, waxed paper or a lid.
4. Do not open the door or touch the "STOP/CLEAR" key during the sensing time. When sensing time is over, the oven beeps twice and the remaining cooking time will appear in the display window. At this time you can open the door to stir, turn or rearrange the food.

SENSOR COOKING GUIDE

Appropriate containers and coverings help assure good Sensor cooking results.

1. Always use microwavable containers and cover them with lids or vented plastic wrap.
2. Never use tight-sealing plastic covers. They can prevent steam from escaping and cause food to overcook.
3. Match the amount of the size of the container. Fill containers at least half full for best results.
4. Be sure the outside of the cooking container and the inside of the microwave oven are dry before placing food in the oven. Beads of moisture turning into steam can mislead the sensor.



ADDING OR SUBTRACTING COOK TIME

If the SENSOR function is too long or too short, you can increase or decrease the cook time by 10% after choosing the function. You can only increase or decrease cook time before cooking starts.

Example: If you want to adjust the Sensor Cook (casserole) cooking time for longer time.



1. Touch **STOP/CLEAR**.



2. Touch **COOK**.

2

3. Choose food category.

9

4. Touch number **9**.

Cook time	Touch pad number
Less	7
Normal	8
More	9

VEGETABLE

VEGETABLE has preset cook powers for 3 food categories: **Fresh, Frozen, and Canned**.

Example: To reheat Frozen Vegetable.



1. Touch **STOP/CLEAR**.



2. Touch **VEGETABLE**.

2

3. Choose food category.

Category	Touch pad number
Fresh	1
Frozen	2
Canned	3

When the cook time is over, you will hear four beeps and **END** will display.

POPCORN

POPCORN lets you pop commercially packaged microwave popcorn. Pop only one package at a time. For best results, use fresh bags of popcorn.

Example: To pop 3.5 oz.



1. Touch **STOP/CLEAR**.



2. Touch **POPCORN**.
When the cook time is over, you will hear four beeps and **END** will display.

CAUTION: Do not leave microwave unattended while popcorn.

PIZZA

Reheating pizza with PIZZA lets you reheat one or several slices of pizza without selecting cooking times and power levels.

Example: To reheat 2 slices of pizza.



1. Touch **STOP/CLEAR**.



2. Touch **PIZZA**.
When the cook time is over, you will hear four beeps and **END** will display.

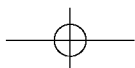

POTATO

Cooking with POTATO lets you bake one or several potatoes without selecting cooking times and power levels.

NOTE:

- **Before baking**, pierce potato with fork several times.
- **After baking**, let stand for 5 minutes wrapped.

Example: To cook 2 potatoes.







1. Touch **STOP/CLEAR**.
2. Touch **POTATO**.
When the cook time is over, you will hear four beeps and **END** will display.

COOK

Using COOK lets you heat common microwave-prepared foods without needing to program times and Cook Powers. Sensor Cook has preset Cook Power for 3 food categories: **Frozen Entree, Casserole, and Rice**.

Example: To cook Rice.





3

1. Touch **STOP/CLEAR**.
2. Touch **COOK**.
3. Choose food category.

Category	Touch pad number
Frozen Entree	1
Casserole	2
Rice	3

When the cook time is over, you will hear four beeps and **END** will display.

REHEAT

REHEAT lets you heat foods without needing to program times and Cook Powers. REHEAT has preset Cook Powers for 3 categories: **Casserole, Dinner Plate, and Soup/Sauce**.

Example: To reheat Casserole.





1

1. Touch **STOP/CLEAR**.
2. Touch **REHEAT**.
3. Choose food category.

Category	Touch pad number
Casserole	1
Dinner Plate	2
Soup/Sauce	3

When the cook time is over, you will hear four beeps and **END** will display.

QUICK DEFROST

The QUICK DEFROST feature provides you with the quick defrosting method for 1, 0 pound frozen foods. The oven automatically sets the defrosting time for ground beef.

Example: To defrost 1lb ground beef.



1. Touch **QUICK DEFROST** pad.



2. Touch **START** pad.

EXPRESS DEFROST

Your microwave oven is preset with three defrost sequences. Using EXPRESS DEFROST is the best way to defrost frozen foods. The Express Defrost Sequence Table below provides some basic guidelines for using the three defrost sequences.

Example: To defrost 1,2 lbs of ground beef.



1. Touch **STOP/CLEAR**.



2. Touch **EXPRESS DEFROST**.

1

3. Choose food category.

Category	Touch pad number
Meat	1
Poultry	2
Fish	3

1 2

4. Enter the weight.



5. Touch **START**.

6. After 1/2 of the defrost time is over, The display will prompt you to turn food over. Open door, turn food over, and shield any warm portions.



7. Close the door and restart.

8. When the defrost time is over, you will hear four beeps and **END** will display.

NOTE: If you do not open the door within 3 seconds, the display will resume the countdown.

Weight conversion chart

You are probably used to food weights as being in pounds and ounces that are fractions of a pound (for example 4 ounces equals 1/4 pound).

However, in order to enter food weight in EXPRESS DEFROST, you must specify pounds and tenths of a pound. If the weight on the food package is in fractions of a pound, you can use the following chart to convert the weight to decimals.

EQUIVALENT OUNCE WEIGHT	NUMBER AFTER DECIMAL
1.6	.10
3.2	.20
4.0	.25 One-Quarter Pound
4.8	.30
6.4	.40
8.0	.50 One- Half Pound
9.6	.60
11.2	.70
12.0	.75 Three-Quarters Pound
12.8	.80
14.4	.90
16.0	1.00 One Pound

DEFROSTING TIPS

- When using EXPRESS DEFROST, the weight to be entered is the net weight in pounds and tenths of pounds (the weight of the food minus the container).
- Only use EXPRESS DEFROST for raw food. EXPRESS DEFROST gives best results when food to be thawed is a minimum of 0°F (taken directly from a "true" freezer). If food has been stored in a refrigerator-freezer that does not maintain a temperature of 5°F or below, always program a lower food weight (for a shorter defrosting time) to prevent cooking the food.
- If the food is stored outside the freezer for up to 20 minutes, enter a lower food weight.
- The shape of the package alters the defrosting time. Shallow rectangular packets defrost more quickly than a deep block.
- Separate pieces as they begin to defrost. Separated pieces defrost more easily.
- You can use small pieces of aluminum foil to shield foods like chicken wings, leg tips, and fish tails, but the foil must not touch the side of the oven. Foil can damage the oven lining.
- Shield areas of food with small pieces of foil if they start to become warm.
- For better results, a preset standing time is included in the defrosting time.

OPERATION

EXPRESS DEFROST CHART

Meat setting

FOOD	SETTING	AT BEEP	SPECIAL INSTRUCTIONS
BEEF			Meat of irregular shape and large, fatty cuts of meat should have the narrow or fatty areas shielded with foil at the beginning of a defrost sequence.
Ground beef (bulk)	MEAT	Remove thawed portions with fork. Turn over. Return remainder to oven.	Do not defrost less than 1/4 lb. Freeze in doughnut shape.
Ground beef (patties)	MEAT	Separate and rearrange.	Do not defrost less than two oz.patties. Depress center when freezing.
Round steak	MEAT	Turn over. Cover warm areas with aluminum foil.	Place on a microwavable roasting rack.
Tenderloin steak	MEAT	Turn over. Cover warm areas with aluminum foil.	Place on a microwavable roasting rack.
Stew beef	MEAT	Remove thawed portions with fork. Separate remainder. Return remainder to oven.	Place in a microwavable baking dish.
Pot roast, chuck roast	MEAT	Turn over. Cover warm areas with aluminum foil.	Place on a microwavable roasting rack.
Rib roast	MEAT	Turn over. Cover warm areas with aluminum foil.	Place on a microwavable roasting rack.
Rolled rump roast	MEAT	Turn over. Cover warm areas with aluminum foil.	Place on a microwavable roasting rack.
LAMB			
Cubes for stew	MEAT	Remove thawed portions with fork. Return remainder to oven.	Place in a microwavable baking dish.
Chops (1 inch thick)	MEAT	Separate and rearrange.	Place on a microwavable roasting rack.
PORK			
Chops (1 inch thick)	MEAT	Separate and rearrange.	Place on a microwavable roasting rack.
Hot dogs	MEAT	Separate and rearrange.	Place on a microwavable roasting rack.
Spareribs Country style ribs	MEAT	Turn over. Cover warm areas with aluminum foil.	Place on a microwavable roasting rack.
Sausage, links	MEAT	Separate and rearrange.	Place on a microwavable roasting rack.
Sausage, bulk	MEAT	Remove thawed portions with fork. Turn over. Return remainder to oven.	Place in a microwavable baking dish.
Loin roast, boneless	MEAT	Turn over. Cover warm areas with aluminum foil.	Place on a microwavable roasting rack.

OPERATION

EXPRESS DEFROST CHART (continued)

Poultry setting

FOOD	SETTING	AT BEEP	SPECIAL INSTRUCTIONS
CHICKEN Whole	POULTRY	Turn over (finish defrosting breast-side down). Cover warm areas with aluminum foil.	Place chicken breast-side-up on a microwavable roast rack. Finish defrosting by immersing in cold water. Remove giblets when chicken is partially defrosted.
		Cut-up	Turn over. Cover warm areas with aluminum foil. Separate pieces and rearrange.
CORNISH HENS Whole	POULTRY	Turn over. Cover warm areas with aluminum foil.	Place on a microwavable roasting rack. Finish defrosting by immersing in cold water.
TURKEY Breast	POULTRY	Turn over. Cover warm areas with aluminum foil.	Place on a microwavable roasting rack. Finish defrosting by immersing in cold water.

Fish setting

FOOD	SETTING	AT BEEP	SPECIAL INSTRUCTIONS	
FISH Filletts	FISH	Turn over. Separate fillets when partially thawed if possible.	Place in a microwavable baking dish. Carefully separate fillets under cold water.	
		Steaks	Separate and rearrange.	Place in a microwavable baking dish. Run cold water over to finish defrosting.
		Whole		Place in a microwavable baking dish. Cover head and tail with foil; do not let foil touch sides of microwave. Finish defrosting by immersing in cold water.
SHELLFISH				
Crabmeat	FISH	Break apart.	Place in a microwavable baking dish.	
Lobster tails	FISH	Rearrange.	Place in a microwavable baking dish.	
Shrimp	FISH	Separate and rearrange.	Place in a microwavable baking dish.	
Scallops	FISH	Separate and rearrange.	Place in a microwavable baking dish.	

NOTE : Food to be defrosted must be not more than 6.0 lbs. (4.0kg)

* Available weight is 0.1~6.0 lbs. (0.1~4.0kg)

OPERATION

USE OF THE TWO POSITION METAL RACK

The two position Metal Rack gives you extra space when cooking in more than one container at the same time. The metal rack can be turned upside/down to help fit taller containers on the bottom of the oven.

NOTE:

- Rack must be on four supports when used.
- Avoid having rack touching metal walls.
- Insert the rack securely into the four supports on the side walls of the oven.
- Turn the rack upside-down when using taller containers on the bottom of the oven.
- Use the rack only when cooking food on two levels.
- Food microwave best when place directly on the oven floor.
- Do not store or cook with rack on floor of the oven. Product damage may result.
- Do not store microwave browning dish on rack.

How to reheat several different type of foods together. When heating several different type of food together, foods which should be served hot must be placed on the oven floor, While foods which need only to be warm should be placed on the rack.

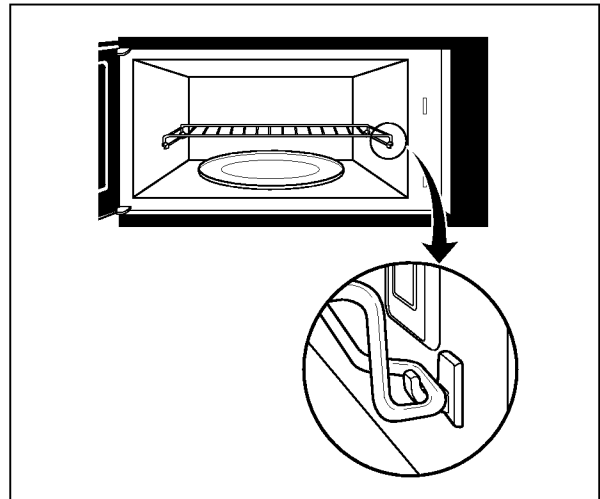
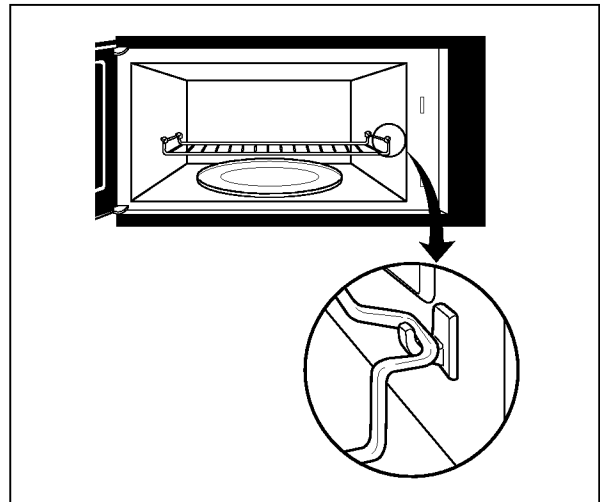

WARNING:

DO NOT RUN THE OVEN EMPTY, WITHOUT FOOD IN IT.

MAINTENANCE

CARE AND CLEANING

For best performance and safety, keep the oven clean inside and outside. Take special care to keep the inner door panel and the oven front frame free of food or grease build-up.

Never use rough powder or pads. Wipe the microwave oven inside and out, including the hood bottom cover, with a soft cloth and a warm(not hot) mild detergent solution. Then rinse and wipe dry. Use a chrome cleaner and polish on chrome, metal and aluminum surfaces. Wipe spatters immediately with a wet paper towel, especially after cooking chicken or bacon. Clean your oven weekly or more often, if needed.

METAL RACK

Wash the metal rack with a mild soap and a soft or nylon scrub brush. Dry completely. Do not use abrasive scrubbers or cleaners to clean rack.

CLEANING THE GREASE FILTER

The grease filter should be removed and cleaned often, at least once a month.

1. To remove grease filter, slide filter to the side. Pull filter downward and push to the other side. The filter will drop out.

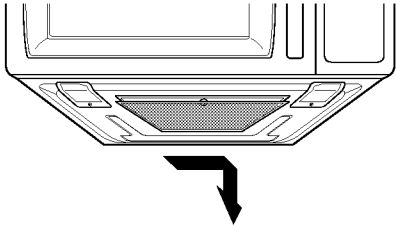

2. Soak grease filter in hot water and a mild detergent. Rinse well and shake to dry. **Do not use ammonia or place in a dishwasher. The aluminum will darken.**

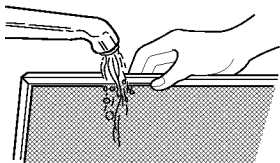

3. To reinstall the filter, slide it into the side slot, then push up and toward oven center to lock.

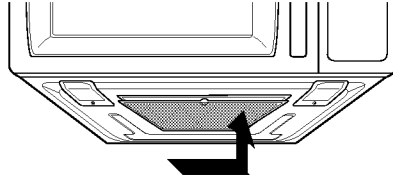

NOTE: **Do not** operate the hood without the filter in place.

CHARCOAL FILTER REPLACEMENT

If your oven is vented inside, the charcoal filter should be replaced every 6 to 12 months, and more often if necessary. The charcoal filter cannot be cleaned. To order a new charcoal filter, contact the Service Center.

1. Remove the two vent grille mounting screws. (2 middle screws)
2. Tip the grille forward, then lift it out

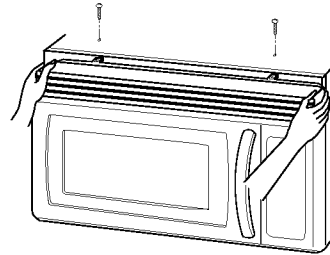

3. Remove old filter.

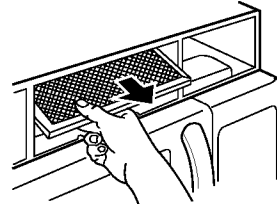

4. Slide a new charcoal filter into place. The filter should rest at the angle shown and set the clock.

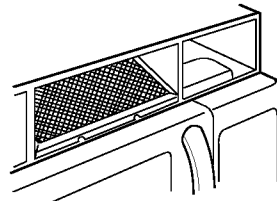

5. Slide the bottom of the vent cover into place. Push the top until it snaps into place. Replace the mounting screws. Turn the power back on at the main power supply and set the clock.

MAINTENANCE

COOKTOP/NIGHT LIGHT REPLACEMENT

1. Unplug oven or turn off power at the main power supply.
2. Remove the bulb cover mounting screws.

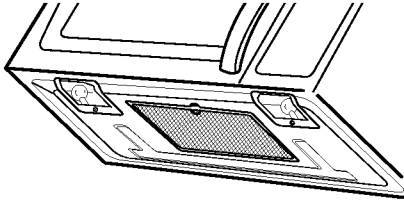

3. Replace bulb(s) with 30 watt appliance bulb(s).
4. Replace bulb cover, and mount screw.
5. Turn the power back on at the main power supply.

OVEN LIGHT REPLACEMENT

1. Unplug oven or turn off power at the main power supply.
2. Remove the vent cover mounting screws. (2 middle screws)
3. Tip the cover forward, then lift out to remove.

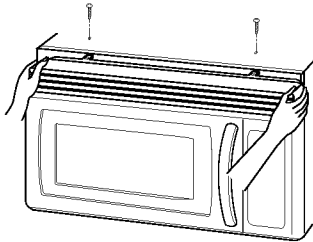

4. Lift up the bulb holder.

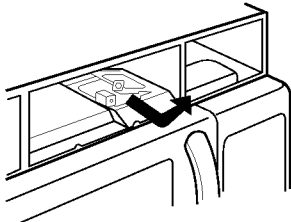
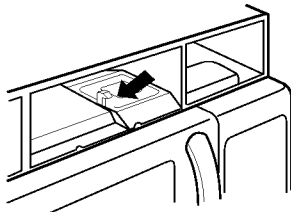

5. Replace bulb with a 30 or 40 watt appliance bulb.
6. Replace the bulb holder.
7. Slide the top of the vent cover into place. Push the bottom until it snaps into place. Replace the mounting screws. Turn the power back on at the main power supply.

QUESTIONS AND ANSWERS

Q. Can I use a rack in my microwave oven so that I may reheat or cook in two levels at a time?

- A. Only use the rack that is supplied with your microwave oven. Use of any other rack can result in poor cooking performance and/or arcing and may damage your oven.

Q. Can I use either metal or aluminum pans in my microwave oven?

- A. Usable metal includes aluminum foil for shielding (use small, flat pieces), and shallow foil trays (if tray is 3/4 inch deep and filled with food to absorb microwave energy). Never allow metal to touch walls or door.

Q. Sometimes the door of my microwave oven appears wavy. Is this normal?

- A. This appearance is normal and does not affect the operation of your oven.

Q. What are the humming noises that I hear when my microwave oven is operating?

- A. You hear the sound of the transformer when the magnetron tube cycles on and off.

Q. Why does the dish become hot when I microwave food in it? I thought that this should not happen.

- A. As the food becomes hot it will conduct the heat to the dish. Use hot pads to remove food after cooking.

Q. What does "standing time" mean?

- A. "Standing time" means that food should be taken out of the oven and covered for additional time after cooking. This process allows the cooking to finish, saves energy and frees the oven for other purpose.

Q. Can I pop popcorn in my microwave oven? How do I get the best results?

- A. Yes. Pop packaged microwave popcorn following manufacturer's guidelines or use the preprogrammed Popcorn pad. Do not use regular paper bags. Use the "listening test" by stopping the oven as soon as the popping slows to a "pop" every one or two seconds. Do not try to repop unpopped kernels. You can also use special microwave poppers. When using a popper, be sure to follow manufacturer's directions. Do not pop popcorn in glass utensils.

Q. Why does steam come out of the air exhaust vent?

- A. Steam is normally produced during cooking. The microwave oven has been designed to vent this steam out the top vent.

MAINTENANCE

You may microwave in many more utensils than you can use on the stove or in a conventional oven, because microwaves penetrate them safely still cooking the food.

Below are listed the utensils you can safely cook with and those you must avoid. To test whether you can safely with a utensil not on the lists below, do the following:

1. Place the utensil empty in the microwave oven.
2. Measure 1 cup of water in a glass measuring cup and place in the oven beside the utensil.
3. Microwave on HI Power for 1 minute.
4. If the utensil is warm to the touch at the end of this time, you should not use it for microwave cooking.

MICROWAVE UTENSIL GUIDE

USE	DO NOT USE
<p>OVENPROOF GLASS (treated for high intensity heat): utility dishes, loaf dishes, pie plates, cake plates, liquid measuring cups, casseroles and bowls without metallic trim.</p> <p>CHINA: bowls, cups, serving plates and platters without metallic trim.</p> <p>PLASTIC: Plastic wrap (as a cover)-- lay the plastic wrap loosely over the dish and press it to the sides. Vent plastic wrap by turning back one edge slightly to allow excess steam to escape. The dish should be deep enough so that the plastic wrap will not touch the food. As the food heats it may melt the plastic wrap wherever the wrap touches the food. Use plastic dishes, cups, semirigid freezer containers and plastic bags only for short cooking time. Use these with care because the plastic may soften from the heat of the food.</p> <p>PAPER: Paper towels, waxed paper, paper napkins and paper plates with no metallic trim or design. Look for the manufacturer's label for use in the microwave oven.</p>	<p>METAL UTENSILS: Metal shields the food from microwave energy and produces uneven cooking. Also avoid metal skewers, thermometers or foil trays. Metal utensils can cause arcing, which can damage your microwave oven.</p> <p>METAL DECORATION: Metal-trimmed or metal-banded dinnerware, casserole dishes, etc. The metal trim interferes with normal cooking and may damage the oven.</p> <p>ALUMINUM FOIL: Avoid large sheets of aluminum foil because they hinder cooking and may cause harmful arcing. Use small pieces of foil to shield poultry legs and wings. Keep ALL aluminum foil at least 1 inch from the side walls and door of the oven.</p> <p>WOOD: Wooden bowls and boards will dry out and may split or crack when you use them in the microwave oven. Baskets react in the same way.</p> <p>TIGHTLY COVERED UTENSILS: Be sure to leave openings for steam to escape from covered utensils. Pierce plastic pouches of vegetables or other food items before cooking. Tightly closed pouches could explode.</p> <p>BROWN PAPER: Avoid using brown paper bags. They absorb too much heat and could burn.</p> <p>FLAWED OR CHIPPED UTENSILS: Any utensil that is cracked, flawed or chipped may break in the oven.</p> <p>METAL TWIST TIES: Remove metal twist ties from plastic or paper bags. They become hot and could cause a fire.</p>

BEFORE CALLING FOR SERVICE

Check the following list to be sure a service call is really necessary. A quick reference of this manual as well as reviewing additional information on items to check, may prevent an unneeded service call.

If nothing on the oven operates:

- check for a blown circuit fuse or a tripped main circuit breaker.
- check if oven is properly connected to electric circuit in house.
- check that controls are set properly.

If the oven interior light does not work:

- the light bulb is loose or defective.

If oven will not cook:

- check that control panel was programmed correctly.
- check that door is firmly closed.
- check that Start Pad was touched.
- check that probe was inserted correctly into receptacle.
- check that timer wasn't started instead of a cook function.

If oven takes longer than normal to cook or cooks too rapidly:

- be sure the Power Level is programmed properly.

If the time of day clock does not always keep correct time:

- check that the power cord is fully inserted into the outlet receptacle.
- be sure the oven is the only appliance on the electrical circuit.

If food cooks unevenly:

- be sure food is evenly shaped.
- be sure food is completely defrosted before cooking.
- check placement of aluminum strips used to prevent overcooking.

If food is undercooked:

- check recipe to be sure all directions (amount, time, & power levels) were correctly followed.
- be sure microwave oven is on a separate circuit.
- be sure food is completely defrosted before cooking.

If food is overcooked:

- check recipe to be sure all directions (amount, power level, time, size of dish) were followed.

If arcing (sparks) occur:

- be sure microwavable dishes were used.
- be sure wire twist ties weren't used.
- be sure oven wasn't operated when empty.
- make sure metal rack (if used) is properly, installed on 4 supports.

If the Display shows a time counting down but the oven is not cooking:

- check that door is firmly closed.
- check that Timer wasn't started instead of a cooking function.

BEFORE CALLING FOR SERVICE

You can often correct operating problems yourself. If your microwave oven fails to work properly, locate the operating problem in the chart below and try the solutions marked for each problem. If the microwave oven still does not work properly, contact the nearest Sears Service center. Sears Service Centers are fully equipped to handle your service requirements.

PROBLEM	SOLUTION
Oven will not start	Is power cord plugged in? Is door closed? Cooking time not set. Temperature not set or probe not plugged in.
Arcing or Sparking	Use approved cookware only. Properly position temperature probe. Do not operate with oven empty.
Time of day incorrect	Reset time of day.
Probe Light Flashes	Is temperature probe properly plugged in?
Unevenly Cooked Foods	Use approved cookware only. Turn or stir food. Completely defrost food.
Overcooked Foods	Properly position temperature probe. Use correct time. / Power level setting. Use correct temp setting.
Undercooked Foods	Use approved cookware only. Properly position temperature probe. Completely defrost food. Use correct time. / Power level setting. Use correct temp setting. Check see that oven ventilation ports are not restricted.
Improper Defrosting	Use approved cookware only. Turn or stir food. Use correct time. / Power level setting.
Oven Lamp does not Light	Is power cord plugged in? Is door closed? Cooking time not set. Is light bulb burned out?

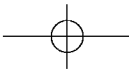

®

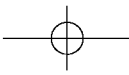
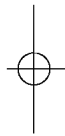

SEARS SERVICE

WE SERVICE WHAT WE SELL

"We Service What We Sell" is our assurance to you can depend on SEARS for service because SEARS service is nationwide.

Your Kenmore Microwave Oven has added value when you consider that SEARS has a service unit near you, staffed by Trained Technicians-Professional technicians specifically trained on Kenmore Microwave Ovens, having the parts, tools and equipment to ensure that we meet our pledge to you. "We Service What We sell!"

TO FURTHER ADD TO THE VALUE OF YOUR MICROWAVE OVEN, BUY A SEARS MAINTENANCE AGREEMENT.

Kenmore Microwave Ovens are designed, manufactured, and tested for years of dependable operation. Yet any modern appliance may require service from time to time. A SEARS Maintenance Agreement is more than an extension of the Warranty.

It provides complete protection from unexpected repair bills and undue inconvenience. It assures you of maximum efficiency from your Microwave Oven.

Here's a comparative Warranty and Maintenance Agreement chart showing you the benefits of a SEARS Maintenance Agreement.

YEARS OF OWNERSHIP COVERAGE	1st YEAR	2nd YEAR	3rd YEAR	4th YEAR	5th YEAR
1. Replacement of magnetron	W	W	Part-W Labour-MA	Part-W Labour-MA	Part-W Labour-MA
Parts and Service 2. Required due to defects in materials or workmanship	W	W	MA	MA	MA
3. Mechanical adjustment and required service	W	W	MA	MA	MA
4. All parts and service required for proper operation not covered by the warranty.	MA	MA	MA	MA	MA
5. Even if the problem turns out to be non-technical such as customer instructions, there will be no charge for service.	MA	MA	MA	MA	MA
6. Annual preventive maintenance check at your request.	MA	MA	MA	MA	MA

MA-MAINTENANCE AGREEMENT
W-WARRANTY

CONTACT YOUR KENMORE SALESPERSON OR LOCAL SEARS SERVICE CENTER TODAY AND PURCHASE A SEARS MAINTENANCE AGREEMENT.

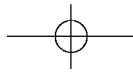

WARRANTY

KENMORE MICROWAVE WARRANTY

- For "TWO YEARS" from date of purchase, Sears will repair any defect in material or workmanship subject to exclusions below free of charge, labour included.
- For the next "THREE" years Sears will replace the Magnetron free of charge, labour not included.
- This warranty is in addition to any statutory warranty.

PRODUCT CATEGORY

SERVICE

Counter Top Microwave (all sizes)

Carry in

Micro/Convection and Over The Range

In Home

WHAT IS NOT COVERED:

1. Installation.
2. Damage resulting from improper voltage.
3. Service required because of damage due to misuse or abuse.
4. Service required as a result of fire, flood, or acts of God.

Sears does not authorize any person or representative to make any other warranty or assume for it any liability other than those contained herein. Any agreement, verbal or written, outside of, or creating any other warranties in addition to or contradictory to the foregoing, shall be void and of no and of no effect. The above warranty applies only to Kenmore Microwave Ovens which are used for private household purposes.

HOW TO OBTAIN WARRANTY SERVICE

1. For "Carry In", simply bring the microwave oven to the nearest Sears Service Centre or Store.
2. For "In Home" contact the nearest Sears Service Centre or Store.

SEARS CANADA INC.
222 Jarvis Street, Toronto, Ontario M5B 2B8

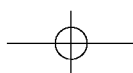

SERVICE AND REPAIR PARTS CALL 1-800-665-4455*

Keep this number handy should you require a service call or need to order repair parts. If ordering parts make sure you have the name, make and model no. of the merchandise and the name and number of the part you wish to order.

*If calling locally, please use one of the following numbers:

Regina-566-5124

Montreal-333-5740

Toronto-744-4900

Halifax-454-2444

Kitchener-894-7590

Ottawa-738-4440

Vancouver-420-8211