



REFRIGERATOR- FREEZER OWNER'S MANUAL

PLEASE
READ THIS OWNER'S MANUAL THOROUGHLY
BEFORE OPERATING AND KEEP IT HANDY
FOR REFERENCE AT ALL TIMES.

FRIGORIFERO- CONGELATORE LIBRETTO ISTRUZIONI

LEGGERE QUESTO
LIBRETTO D'ISTRUZIONI PRIMA DELL'USO
E TENERLO A PORTATA DI MANO PER
SUCCESSIVE CONSULTAZIONI.

ΨΥΓΕΙΟΚΑΤΑΨΥΚΤΗΣ ΟΔΗΓΙΕΣ ΧΡΗΣΕΩΣ

ΓΙΑ ΑΣΦΑΛΗΜΕΣ ΠΡΟΣΕΚΤΙΚΑ ΑΥΤΟ
ΤΟ ΕΓΧΕΙΡΙΔΙΟ ΟΔΗΓΙΩΝ ΧΡΗΣΕΩΣ ΠΡΙΝ
ΑΡΧΙΣΕΤΕ ΝΑ ΧΡΗΣΙΜΟΠΟΙΕΙΤΕ ΤΗ ΣΥΣΚΕΥΗ
ΣΑΣ ΚΑΙ ΦΥΛΑΞΤΕ ΤΟ ΣΕ ΒΟΛΙΚΟ ΜΕΡΟΣ ΓΙΑ
ΝΑ ΤΟ ΣΥΜΒΟΥΛΕΥΕΣΤΕ ΟΠΟΤΕ ΧΡΕΙΑΣΤΕΙ.

CONTENTS

INSTALLATION	3
INNER PARTS	4
OPERATIONS	5
Auto Off Feature Of Lamp Inside	
Before Setting The Temperature	
Controls For Refrigerator Compartment	
Super Cool	
Energy Saving	
Door Alarm	
Self Test	
Controls For Freezer Compartment	
Ice Making	
Fresh Zone	
Defrosting	
Deodorizer(Optional)	
F.I.R Lamp(Option)	
Water dispenser	
SUGGESTIONS ON FOOD STORAGE	13
CLEANING	14
GENERAL INFORMATION	14
LAMP REPLACEMENT	15
IMPORTANT WARNINGS	15
BEFORE CALLING FOR SERVICE	16

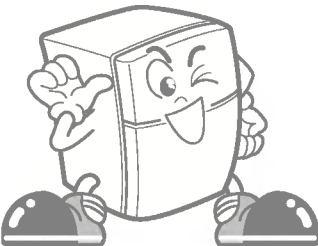



THIS REFRIGERATOR IS MANUFACTURED WITH GREAT CARE, AND UTILIZES THE LATEST IN TECHNOLOGY.

WE ARE CONFIDENT THAT YOU WILL BE FULLY SATISFIED WITH ITS PERFORMANCE AND RELIABILITY.

BEFORE YOU START YOUR REFRIGERATOR, PLEASE READ THIS BOOKLET CAREFULLY.

IT PROVIDES EXACT INSTRUCTIONS FOR INSTALLATION, OPERATION AND MAINTENANCE, AND ALSO SUPPLIES SOME USEFUL HINTS.

INSTALLATION

1. Select a good location.
Place your refrigerator where it is easy to use.
2. Avoid placing the unit near heat sources, direct sunlight or moisture.
3. There must be proper air circulation around your refrigerator to keep it operating efficiently. If your refrigerator is placed in a recessed area in the wall, allow at least 10 inches or greater clearance above the refrigerator and 2 inches or more from the wall.
The refrigerator should be elevated 1 inch from the floor, especially if it is carpeted.
4. To avoid vibrations, the unit must be level. If required, adjust the leveling screws to compensate for unevenness of the floor. The front should be slightly higher than the rear to aid in door closing.
Leveling screws can be turned easily by tipping the cabinet slightly.
Turn the leveling screws clockwise() to raise the unit, counterclockwise() to lower it.
5. Don't install this appliance below 5 °C. It may cause the debasement of the refrigerator.

NEXT

1. Clean your refrigerator thoroughly and wipe off all dust accumulated during shipping.
2. Install accessories such as ice cube box, etc., in their proper places. They are packed together to prevent possible damage during shipment.
3. You have a model with bar-type handle, assemble the handle according to instruction card.
4. Connect the power supply cord (or plug) to the outlet. Don't double up with other appliances on the same outlet.
5. Prior to storing food, leave your refrigerator on for 2 or 3 hours.
Check the flow of cold air in the freezer compartment to ensure proper cooling.
Your refrigerator is now ready for use.

INNER PARTS

FREEZER COMPARTMENT

Lamp
Shelf

Twisting Ice
Serve(Optional)
or
General Type
Ice Making

REFRIGERATOR COMPARTMENT

Deodorizer

Fresh Zone

Lamp

Shelves

Vegetable Drawer

Used to keep fruits
and vegetables, etc.
fresh and crisp.

Freezer Temperature
Control Dial

Freezer Door Rack

Egg Storage Rack

Water Dispenser

Utility Corner

Leveling Screw

Base Cover

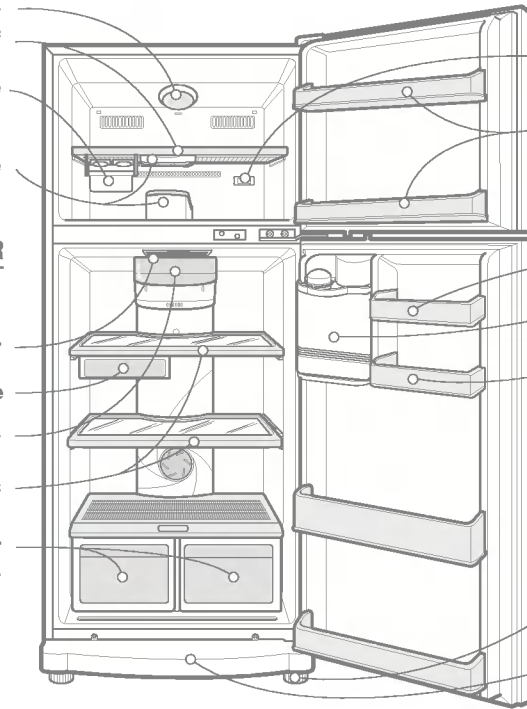

- If you find out some parts which are not in your unit, the parts are applied to other models.

OPERATIONS

AUTO OFF FEATURE OF LAMP INSIDE

When the door is open for 7 minutes or longer, the lamp inside goes off automatically to save energy and prevent overheating. However, the alarm sound continues until the door is closed.

BEFORE SETTING THE TEMPERATURE

- Since the temperature of the refrigerator is automatically kept constant regardless of the season, it is recommended not to change the settings (the controls for the refrigerator and freezer compartments) unless it is necessary.
- This refrigerator has one temperature control button for the refrigerator compartment and one temperature control dial for the freezer compartment.
- The default setting of the temperature control button for the refrigerator compartment is 'Normal'.
- The default setting of the temperature control dial for the freezer compartment is '3'.
- Since this refrigerator uses a thermistor for the refrigerator compartment, the refrigerator starts to run when the temperature of the refrigerator compartment drops.

CONTROLS FOR REFRIGERATOR COMPARTMENT

• Cooling Indicator Lamp:

For 2 minutes since the door of the refrigerator is opened and then closed, the light fluctuates.

• Super Cool:

Feature of cooling food put in the refrigerator quickly. Press "Super Cool" button. By each press, the feature is on/off. When the Super Cool button is not pressed within a certain time after this mode is on, the mode is off automatically.



You can set Refrigerator temperature using the 'REF. TEMP'.

Whenever pressing the button, the LED emit light.

The temperature of the compartment is lowered as the LED luminesce from "MIN" to "MAX".

You can select the desired setting point five steps (from the MIN to the MAX).

For the economic electricity, set the led to the 'MIN' position.

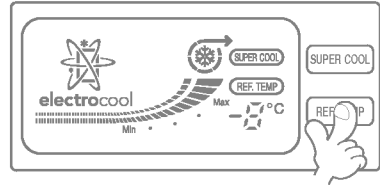

SUPER COOL

- The super cool system operates, when the power is supplied first. So, you can store food more fresh. The super cool system is released when the temperature of refrigerator compartment get specified degree.

- If needed press the 'SUPER COOL' button on the display panel.

The function on and off whenever the button is pressed.

The function is released (off) if you don't cease the function and the food is cooled sufficiently.

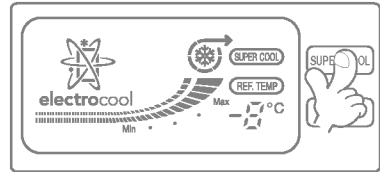

ENERGY SAVING

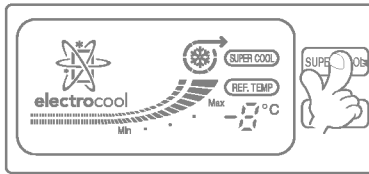

• Super Cool:

- ① Press this button for 5 seconds and the lamp will turn off.
- ② Press the button for 5 seconds again and the lamp will turn on.

- You can reduce the energy consumption when turning off the light of the panel.

DOOR ALARM

When the door of the refrigerator or the freezer is left opened for a while, the alarm sounds three times 1 minute after and then three times every 30 seconds.

SELF TEST

- When a trouble is occurred, this function indicates it. In this case, if you press any operating button, the refrigerator does not operate and displays abnormal.
- At this time, don't disconnect the power cord from the outlet and inquire to the service center.

CONTROLS FOR FREEZER COMPARTMENT

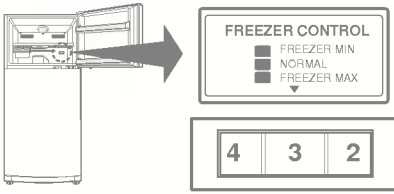

- The higher number the control setting is, the lower the temperature of the Freezer compartment becomes.
- Since the temperature of the refrigerator and freezer compartments is controlled with a fixed amount of cooled air, the refrigerator compartment will be warmer if the freezer compartment becomes colder.
- When the freezer compartment is not cold enough in winter, adjust the control for the freezer to High (7~10).

ICE MAKING

Determine which type ice-making system you have.

General Type

- To make ice cubes, fill the ice tray with water and place it in the freezer.
- To remove ice cubes, hold the tray at its ends and twist gently.
- To remove ice cubes easily, run water on the tray before twisting.

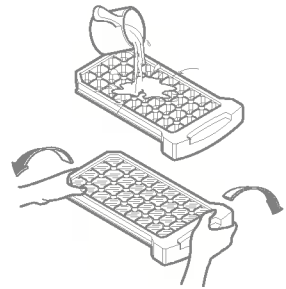

Twisting Ice Serve Type

- To make ice cubes, fill the ice tray with water and insert in its position.
- To remove ice cubes, hold the knob of the tray and turn gently. Then, ice cubes drop in the ice cube

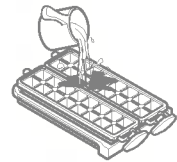
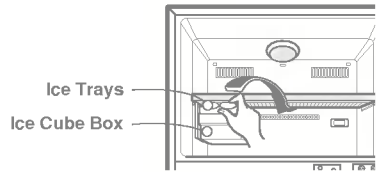

FRESH ZONE

- When the door is opened, the warmer air don't influence in the fresh zone. So you can store food more fresh in it.
- The shelf and inserted fresh zone must be placed at its position. If it is moved, the fresh zone can't fill the role of it.

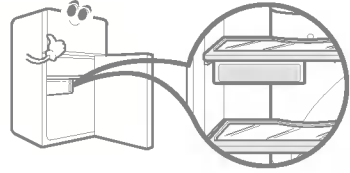

DEFROSTING

- Defrosting takes place automatically.
- The defrosted water flows down to the evaporating tray which located in the lower back side of the refrigerator and is evaporated automatically.

DEODORIZER(OPTIONAL)

- By using an "TiO₂ catalyst," deodorizing performance is guaranteed.
- Unpleasant odor of food in fresh food compartment is deodorized with no harm to you and the food.

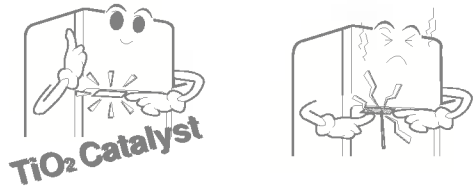

How to use

- As the catalyst is located in cooling air outlet for circulating air in fresh food compartment, there is no need for any handling.
- Do not prick the cooling air outlet with a sharp tip because the deodorizing catalyst may be damaged.
- When storing food with a strong odor, wrap it or store it in a container with a lid because odor may be passed on to other foods.

Re-Using of the catalyst

- Used some length and the odor is strong, the catalyst can be revived and re-used. Separate deodorizer in ceiling of refrigerator compartment, dry using hair drier to remove moisture or malodor and oxidize under sunlight to decomposing malodor by ultraviolet.

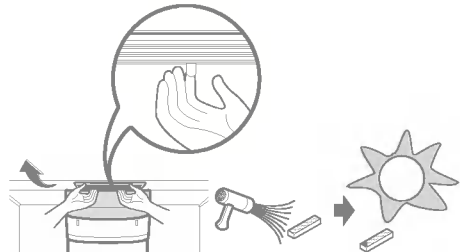

OPERATIONS

F.I.R LAMP(OPTION)

Feature

- Far Infrared Rays emitted from Far Infrared Ray Lamp restrains the dryness of the foods and keeps its original form without transforming.
- By increasing the nucleic acid, Far Infrared Rays also keeps the aroma and the smell of the food for a long time.

More effective food storage.

- It is useful to store the food without seasoning such as salt or sugar, and the food needed to keep as low temperature with the raw food uncooked heating or no disinfecting.
 - (Sliced) : Raw Fish, Meat, Poultry and so on.
- It is useful to keep the original taste of the food by F.I.R's the restraining excessive fermentation and overripe of the foods.
 - Vegetable with spices, Yogurt, and so on.
- It is useful to store the unsuited foods in the Freezer among the cooked foods or that go bad easily.
 - Boiled Egg, Bamboo Shoots, Vegetable for seasoning, and so on.

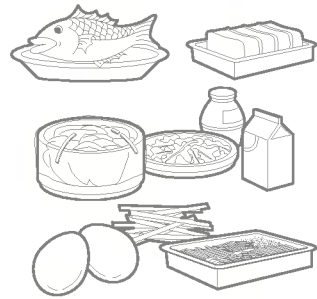

Operating

- When the refrigerator begins to operate, F.I.R Lamp turns on. During the refrigerator's operating, the on and off of the F. I. R Lamp is automatically controlled by the refrigerator inner temperature. Therefore it is not necessary to handle F.I.R Lamp.
- F.I.R Lamp is coated with special materials for the best results of F.I.R Lamp's effect decreases.
- If F.I.R Lamp is veiled or covered, the F.I.R Lamp's effect decreases.
- If you store the foods wrapped in the vinyl or wrapper, not in the vessel with lid, the foods will get more effective F.I.R results.
- If you want to check the F.I.R Lamp operation, don't touch F.I.R Lamp because you may burn your fingers with the high temperature of its surface.

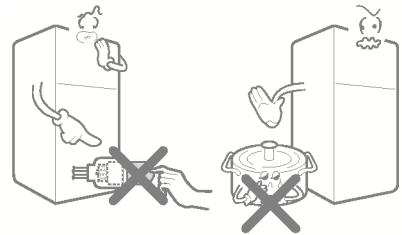

- During F.I.R Lamp operation, don't touch F.I.R Lamp because you may burn your fingers with the high temperature of its surface.

OPERATIONS(water dispenser)

Features

▶ EXTERIOR

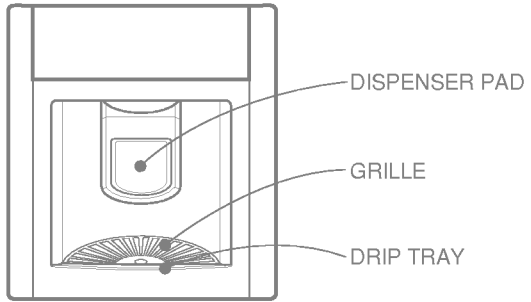

▶ INTERIOR

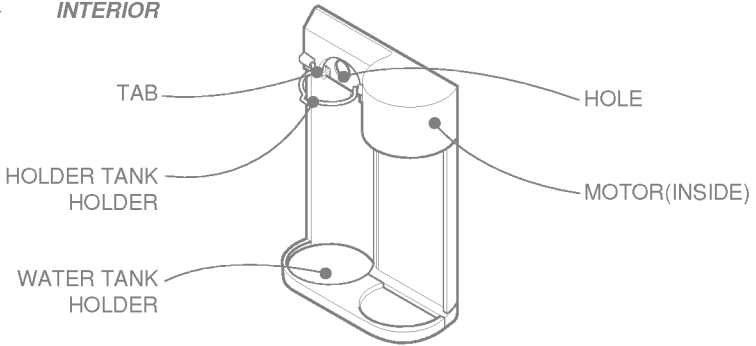

▶ WATER TANK

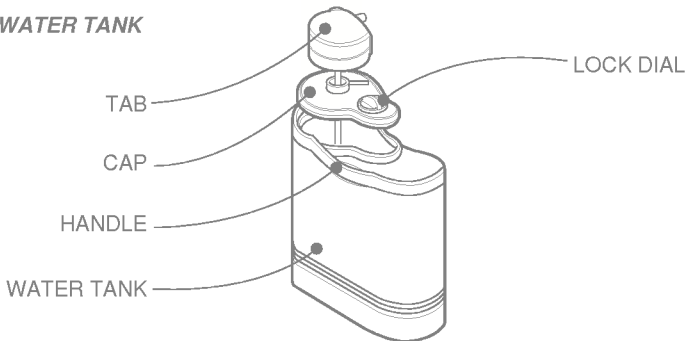

OPERATIONS(water dispenser)

Putting The Water In The Water Tank

1 Turn the lock dial in the direction of the arrow as shown to remove it and pour water into the dispenser water tank.

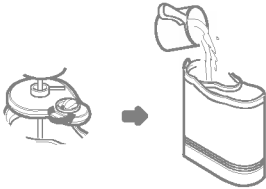

2 Close the cap by tilting it and putting one side in first and then the other side as shown.



3 Place the water tank in the tank holder inside the refrigerator. Make sure that the groove on the connecting part is in position with the tab. Push the connecting part into the hole unit "Clicks".

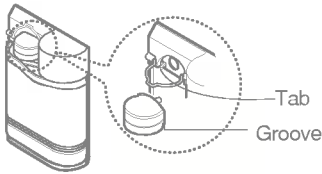

4 Fix the connecting part in place by means of the holder ring as shown.



- Do not use anything other than water including soft drinks, milk and juice.
- Hot water needs to be cooled before being put in the water tank.
- Always use the holder ring to fix the water tank in place to prevent the tank from moving or getting loose.

Drinking

1 Press the dispenser pad with the glass.



2 The water is released when the dispenser pad is pressed. The pad returns to its original position when the glass is removed, and the water stops its flow.

- The motor rotates in reverse for a few seconds after the dispenser is released to dispose of any water remaining in the tubes. (This may cause the sound of water being sucked back inside)

OPERATIONS(water dispenser)

CLEANING

Grille and Drip Tray

- 1 Pull the drip tray out and remove with the grille.
- 2 Dispose of the water in the kitchen sink, wash the drip tray and the grille with a mild detergent and rinse thoroughly.

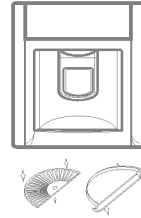
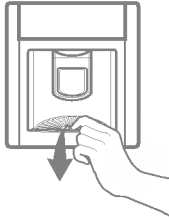

Water Tank

- 1 Remove the cap.
- 2 Clean the inside and outside of the water tank with dishwashing detergent and rinse thoroughly under running water.

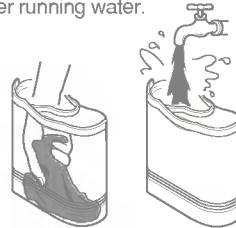

Other Parts

Remove the cap and clean the cap and connecting part with a mild detergent and rinse thoroughly.

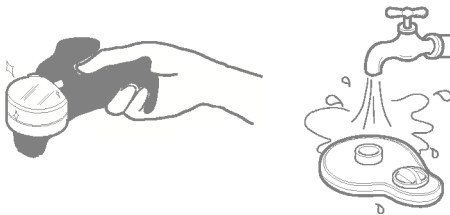

- Use lukewarm water when cleaning.
- Do not use anything other than water. If it is used with soft drinks, put water in the water tank and discharge three or four cups of water shortly.

SUGGESTIONS ON FOOD STORAGE

STORING FOOD

- Store fresh food in the refrigerator compartment. How food is frozen and thawed is an important factor in maintaining its freshness and flavor.
- Do not store food which goes bad easily at low temperatures, such as bananas, pineapples, and melons.
- Allow hot food to cool prior to storing. Placing hot food in the refrigerator could spoil other food, and lead to higher electric bills!
- When storing the food, cover it with vinyl wrap or store in a container with a lid. This prevents moisture from evaporating, and helps food to keep its taste and nutrients.
- Do not block air vents with food. Smooth circulation of chilled air keeps refrigerator temperatures even.
- Do not open the door frequently. Opening the door lets warm air enter the refrigerator, and cause temperatures to rise.

FREEZER COMPARTMENT

- Do not store bottles in the freezer compartment - they may break when frozen.
- Do not refreeze food that has been thawed. This causes loss of taste and nutrition.
- When storing frozen food like ice cream for a long period, place it on the freezer shelf, not in the door rack.
- Loading for Freezing - It is recommended to load newly introduced foods on the following position for freezing:

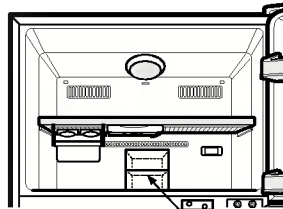

Newly Introduced Food

REFRIGERATOR COMPARTMENT

- Avoid placing moist food deep inside refrigerator shelves, it could freeze upon direct contact with chilled air.
- Always clean food prior to refrigeration. Vegetables and fruits should be washed and wiped, and packed food should be wiped clean, to prevent adjacent food from spoiling.
- When storing eggs in their storage rack, ensure that they are fresh, and always store them in a upright position, which keeps them fresh longer.
- Door rack - Loading the food on the whole area of door rack would cause no problems in performance.



- If you keep the refrigerator in a hot, and humid place, frequently open its door or put a lot of vegetables in it, dew may form in it, which has no effect on its performance. Remove the dew with dust cloth free from care.

CLEANING

It is important that your refrigerator be kept clean to prevent undesirable odors. Spilled food should be wiped up immediately, since it may acidify and stain plastic surfaces if allowed to settle.

Never use metallic scouring pads, brushes, coarse abrasive cleaners or strong alkaline solutions on any surface.

Before you clean, however, remember that damp objects will stick or adhere to extremely cold surfaces. Do not touch frozen surfaces with wet or damp hands.

EXTERIOR - Use a lukewarm solution of mild soap or dish washable solution to clean the durable finish of your refrigerator. Wipe with a clean, damp cloth and then dry.

INTERIOR - Regular cleaning of the interior and interior parts is recommended. Use a lukewarm solution of mild soap or dish washable solution to clean the durable finish of your refrigerator. Wipe with a clean, damp cloth and then dry.

INTERIOR PARTS - Wash compartment shelves, door racks, storage trays and magnetic door seals etc. Use a lukewarm solution of mild soap or dish washable solution to clean the durable finish of your refrigerator. Wipe with a clean, damp cloth and then dry.

WARNING

Always remove power cord from the wall outlet prior to cleaning in the vicinity of electrical parts (lamps, switches, controls, etc.). Wipe up excess moisture with a sponge or cloth to prevent water or liquid from getting into any electrical part and causing electric shock. Do not use flammable or toxic cleaning liquids.

- Caution for Cleaning Not in use : Surface active agent, Car wax, Anticorrosive, All sorts of oil, Gasoline, Acids, Wax.
- Usable Detergent Vegetable dish washable solution, Soapy water
- When careless using, it can occur a color change.

GENERAL INFORMATION

VACATION TIME

During average length vacations, you will probably find it best to leave the refrigerator in operation. Place freezable items in freezer for longer life. When you plan to be away for an extended period, remove all food, disconnect the power cord, clean the interior thoroughly, and leave each door OPEN to prevent odor formation.

POWER FAILURE

Most power failures are corrected in an hour or two and will not affect your refrigerator temperatures. However, you should minimize the number of door openings while the power is off. During power failures of longer duration, place a block of dry ice on top of your frozen packages.

IF YOU MOVE

Remove or securely fasten down all loose items inside the refrigerator. To avoid damaging the leveling screw(s), turn them all the way into the base.

ANTI-CONDENSATION PIPE

The outside wall of the refrigerator cabinet may sometimes get warm, especially just after installation.

Don't be alarmed.

This is due to the anti-condensation pipe, which pumps hot refrigerant to prevent "sweating" on the outer cabinet wall.

Anti-Condensation Pipe



LAMP REPLACEMENT

FREEZER LAMP

To remove the lamp shield inside the freezer compartment, reach behind the shield and pull it forward as shown in the figure on the right.



REFRIGERATOR LAMP

To remove the lamp shield inside the refrigerator compartment, pull it down while pressing the triangular area with your thumb and pull it forward as shown in the figure on the right.

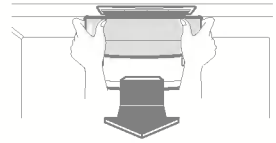

IMPORTANT WARNINGS

DO NOT USE AN EXTENSION CORD

If possible, connect the refrigerator to its own individual electrical outlet to prevent it and other appliances or household lights from causing an overload that could cause a power outage.

ACCESSIBILITY OF SUPPLY PLUG

The refrigerator-freezer should be so positioned that the supply plug is accessible for quick disconnection when accident happens.

SUPPLY CORD REPLACEMENT

If the supply cord is damaged, it must be replaced by the manufacturer or its service agent or a similarly qualified person in order to avoid a hazard.

ABOUT GROUNDING (EARTHING)

In the event of an electric short circuit, grounding (earthing) reduces the risk of electric shock by providing an escape wire for the electric current.

In order to prevent possible electric shock, this appliance must be grounded.

Improper use of the grounding plug can result in an electric shock. Consult a qualified electrician or service person if the grounding instructions are not completely understood, or if you have doubts on whether the appliance is properly grounded.

VERY DANGEROUS ATTRACTION

An empty refrigerator can be a dangerous attraction to children. Remove either gaskets, latches, lids or the entire door from your unused appliance, or take some other action to make it harmless.

**This appliance must be grounded (earthed).
DON'T WAIT! DO IT NOW!**

**Do not store inflammable materials, explosives
or chemicals in the refrigerator.**

BEFORE CALLING FOR SERVICE

SERVICE CALLS CAN OFTEN BE AVOIDED!

IF YOU FEEL YOUR REFRIGERATOR IS NOT OPERATING PROPERLY, CHECK THESE POSSIBLE CAUSES FIRST :

PROBLEM	POSSIBLE CAUSES
REFRIGERATOR DOES NOT OPERATE	<ul style="list-style-type: none">• Has a house fuse blown or circuit breaker tripped?• Has the power cord plug been removed or loosened from the electrical wall outlet?
REFRIGERATOR OR FREEZER COMPARTMENT TEMPERATURE TOO WARM	<ul style="list-style-type: none">• Temperature control not set on proper position.• Appliance is placed close to wall or heat source.• Warm weather-frequent door openings.• Door left open for a long time.• Large amount of foods are kept in the refrigerator.
ABNORMAL NOISE(S)	<ul style="list-style-type: none">• Refrigerator is installed in a weak or uneven place, or leveling screw needs adjusting.• Unnecessary objects placed in the back side of the refrigerator.
REFRIGERATOR HAS ODOR	<ul style="list-style-type: none">• Foods with strong odors should be tightly covered or wrapped.• Interior needs cleaning.
DEW FORMS ON THE CABINET SURFACE	<ul style="list-style-type: none">• Not unusual during periods of high humidity.• Door may have been left ajar.