



Cassette Type Air Conditioner OWNER'S MANUAL

- Please read carefully and thoroughly this manual before operating this unit.
- Contact the authorized SVC man for repair or maintenance of this unit.
- Contact the installer for installation of this unit.
- The appliance is not intended for use by young children or infirm persons without supervision.
- Young children should be supervised to ensure that they do not play with the appliance.

Prior to installation, this air-conditioning unit must be submitted for approval by the

Safety Precautions

Warning2
 Caution3

Operating Instructions

Indoor Unit, Outdoor Unit.....4
 Name and Function of Remote Controller5
 Wireless Remote Controller (optional) ..6
 Set the Current Time and a day of the Week7
 Weekly Program Setting8
 Holiday Setting9
 Timer Setting9
 Self-diagnosis Function9
 Operation Mode10
 Operation Procedure10

Care and Maintenance

Indoor unit20
 Outdoor unit20
 Purifying filter21
 Not used for22

Troubleshooting Tips
 Before You Call For Service23

Safety precautions

To prevent injury to the user or other people and property damage, the following instructions must be followed.

■ Incorrect operation due to ignoring of instruction will cause harm or damage. The seriousness is classified by the following indications.

⚠ **WARNING**

This symbol indicates the possibility of death or serious injury.

⚠ **CAUTION**

This symbol indicates the possibility of injury or damage to properties only.

⚠ **WARNING**

- **Do not install, remove and reinstall the unit by yourself.**
 - Improper installation will cause water leakage, electrical shock, or fire. Please consult authorized dealer or specialist for the installation work. Please note fault caused by improper installation is not covered by warranty.
 - Unit must be installed in an easily accessible area. Any additional cost required to hire a special equipment to service the unit will be the responsibility of the customer.

⚠ **WARNING**



- It will cause electrical shock or fire.
- If the supply cord is damaged, it must be replaced by the manufacturer or its service agent or a similarly qualified person in order to avoid a hazard.



- It may cause electrical shock.



- Otherwise, it will cause electrical shock or fire due to heat generation.



- It will cause electrical shock or fire due to heat generation.



- Since the fan rotates at high speed, this may cause an injury or damage the unit.



- This could damage your health.



- If the unit continues to be operated in an abnormal condition, it may cause a fire, trouble, etc. In this case, consult your dealer.



- If this is done in correctly, it may cause a fire, electric shock, injury by dropping of the unit, water leakage, etc. Consult your dealer.

CAUTION

- Contact the authorized Service technician for repair or maintenance of this unit.
- Contact the installer for installation of this unit.
- The air conditioner is not intended for use by young children or infirm persons without supervision.
- Young children should be supervised to ensure that they do not play with the air conditioner.

CAUTION

• Water may enter the unit and degrade the insulation. It may cause an electric shock.

• An oxygen shortage may occur.

• Since the fan rotates at high speed during operation, it may cause an injury.

• This could injure the pet or plant.

• It may cause a fire or deformation of the cabinet.

• The unit may drop or fall down and cause an injury.

• It may cause imperfect combustion.

• It may cause an injury.

• It may cause an injury through dropping or falling down.

• In the cooling mode, if it is operated in a room with high humidity (80%r.h. or more) for a long time, water condensed in the air conditioner may drop and may wet and spoil furniture, etc.

• It may cause an injury, etc. by falling down.

• Do not use this air conditioner to preserve precision devices, food, animal, plants and art objects.
It may cause deterioration of quality, etc.

• It will cause electrical shock or fire.

• It may cause an injury.

• It will cause an injury by the rotating blower.

Operating Instructions



Indoor Unit, Outdoor Unit

Indoor Unit

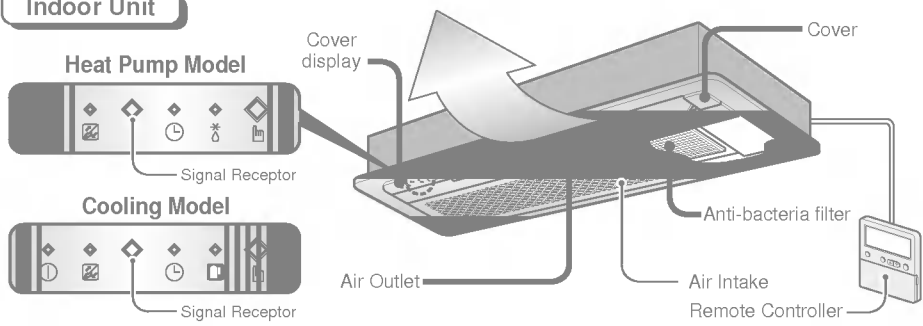

Signal Receptor

Receives the signals from the remote control.
 (Signal receiving sound: two short beeps or one long beep.)

Operation Indication Lamps

①	On/Off	: Lights up during the system operation.
🗑️	Filter Sign	: Lights up after 2400 hours from the time of first operating unit. (Refer to page 19.)
🕒	Timer	: Lights up during Timer operation.
❄️	Defrost Mode	: Lights up during Defrost Mode or Hot Start operation. (Heat pump model only)
🏠	Outdoor Unit Operation	: Lights up during outdoor unit operation. (Cooling model only)
👉	Forced Operation	: Operation procedures when the remote control can't be used.

Outdoor Unit

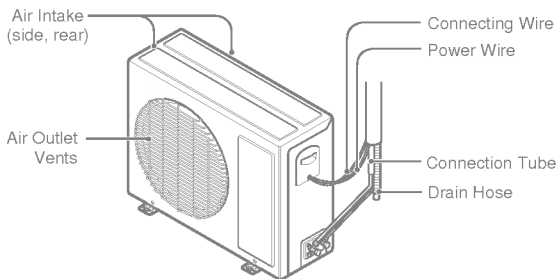

Heat pump model: Cassette Type Air Conditioner for cooling and heating
 Cooling model: Cassette Type Air Conditioner for cooling



Name and Function of Remote Controller

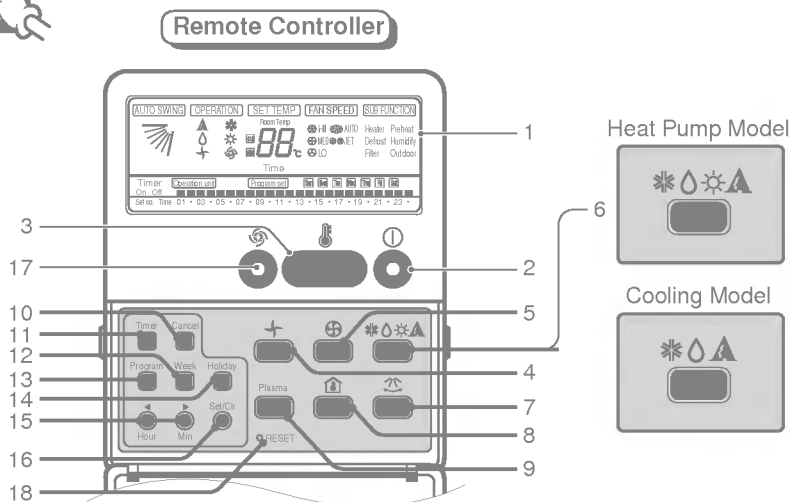

■ Operation display

Displays the operation conditions.

■ On/Off Button

Operation starts when this button is pressed, and stops when the button is pressed again.

■ Set Temperature Button

Used to set the temperature when the desired temperature is obtained.

■ FAN Operation Button

Used to circulate room air without cooling or heating.

■ Fan Speed Button

Used to set the desired fan speed.

■ Operation Mode Selection Button

Used to select the operation mode.

- Auto Operation Mode
- Cooling Operation Mode
- Soft Dry Operation Mode
- Heating Operation Mode(except cooling model)

■ Auto Swing Button

Used to swing up and down.

■ Room Temperature Checking Button

Used to check the room temperature.

■ Plasma Air Clean Button

(For LT-C1262HL only)

■ Timer Cancel Button

Used to cancel the timer.

■ Timer Set Button

Used to set the timer when the desired time is obtained.

■ Week Button

Used to set a day of the week.

■ Program Button

Used to set the weekly timer.

■ Holiday Button

Used to set a holiday of the week.

■ Time Set Button

Used to set the time of the day and change the time in the weekly timer Function.

■ Set and Clear Button

Used to set and clear the weekly timer.

■ Jet Cool Button

Used to select jet cool mode.

■ Reset Button

Used to set the current time and clear the setting time.

※ Display temperature can be different from actual room temperature if the remote controller is installed at the place where sun-rays are falling directly or the place nearby heat source.



Wireless Remote Controller (optional)

This air-conditioner is equipped with wired remote controller basically. But if you want to be available with wireless remote controller, you pay for it.

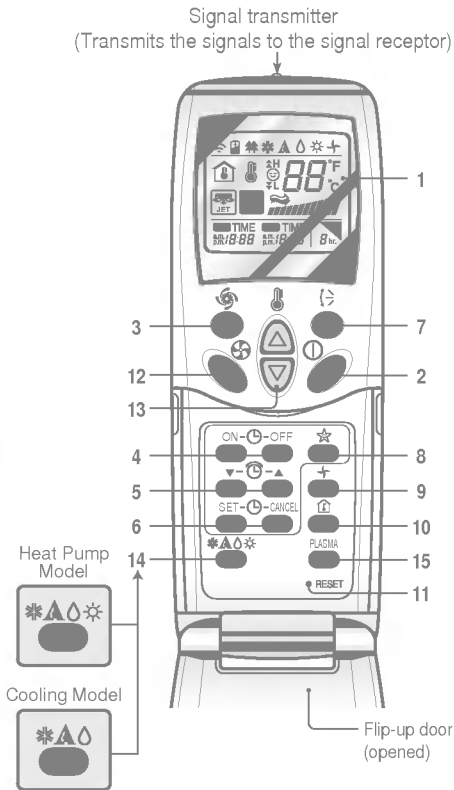

■ OPERATION DISPLAY

Displays the operation conditions.

■ ON/OFF BUTTON

Operation starts when this button is pressed and stops when the button is pressed again.

■ JET COOL BUTTON

Used to select jet cool mode.

■ ON/OFF TIMER BUTTONS

Used to set the time of starting and stopping operation.

■ TIME SETTING BUTTONS

Used to adjust the time.

■ TIMER SET/CANCEL BUTTONS

Used to set the timer when the desired time is obtained and to cancel the Timer operation.

■ AIR SWING BUTTON

Used to swing up and down.

■ SLEEP MODE BUTTON

Used to set Sleep Mode Auto operation.

■ AIR CIRCULATION BUTTON

Used to circulate the room air without cooling or heating (turns indoor fan on/off).

■ ROOM TEMPERATURE CHECKING BUTTON

Used to check the room temperature.

■ RESET BUTTON

Used prior to resetting time or after replacing batteries.

■ INDOOR FAN SPEED SELECTOR

Used to select fan speed in four steps-low, medium, high, or CHAOS.

■ ROOM TEMPERATURE SETTING BUTTONS

Used to select the room temperature.

■ OPERATION MODE SELECTION BUTTON

Used to select the operation mode.

■ PLASMA AIR CLEAN BUTTON

(For LT-C1262HL only)

CAUTION

of handling the Remote Controller

- Aim at the signal receptor on the wired remote controller so as to operate.
- The remote control signal can be received at a distance of up to about 7m.
- Be sure that there are no obstructions between the remote controller and the signal receptor.
- Do not drop or throw the remote controller.
- Do not place the remote controller in a location exposed to direct sunlight, or near the heating unit, or any other heat source.
- Block a strong light over the signal receptor with a curtain or etc. so as to prevent the abnormal operation. (ex:electronic quick start, ELBA, inverter type fluorescent lamp)



Set the Current Time and a day of the Week

- 1** Press the '  ' button.

Each time the button is pressed, the number is changed from **00** to **23**.
You can set the number of the current hour.

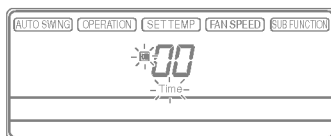

- 2** Press the '  ' button.

Each time the button is pressed, the number is increased from **00** to **59**.
You can set the number of the current minute.

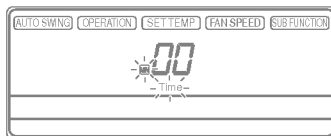
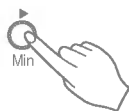

- 3** Press '  ' button.

Each time the button is pressed, a day of the week is shifted from Sunday to Saturday.
You can set the day of the week.

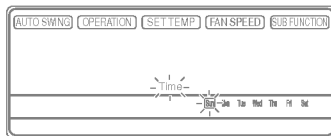

- 4** Press the '  ' button.

If you want to reset the current time and a day of the week, click the Reset button.

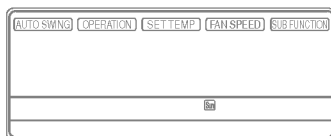



Weekly Program Setting

- 1 Press the Program button.
The remote controller is displayed like below. Then 'Program set', 'Sun' and '01' is blinked.

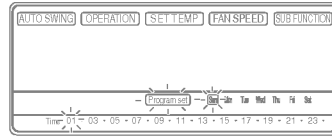

- 2 Press the 'Week' button.
Select the Monday.

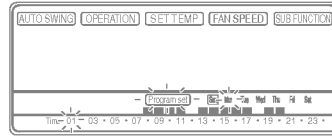

- 3 Change the timer setting until the desired time is set.
After you select a time, push the SET/CLR button once or one more time.

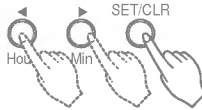

For Example if the air-conditioner is turned on from 6 to 8 and from 13 to 22 and turned off at other time monday, display is as follows. (black bar indicates turn-on, white bar indicates turn-off.)

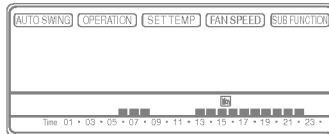

- 4 You can set turn on and turn off time by the day in a week as above.

Holiday Setting

If Tuesday is a holiday in this week, you may set a holiday.

1

Press the Program button.

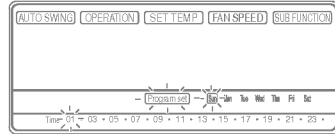

2

Press the Week button.
Select the Tuesday.

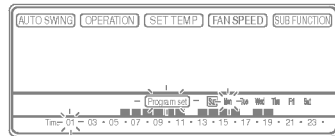

3

Press the Holiday button.

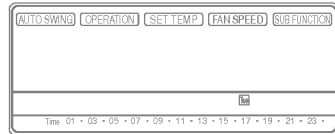

Then the remote controller will be displayed 'Tue'.
The outside rectangular means holiday.

Timer Setting (Delay start/Pre-set stop)

This function is used to turn on or turn off in several hours.

1

Press the Timer button
to turn Timer on or off.



2

Change the timer setting until the desired time is set.



3

If you want to cancel the timer setting, press the Cancel button.



Self-diagnosis Function

'CH' will flash in the remote controller display when a problem occurs.
Then please contact your dealer.

Operation Mode

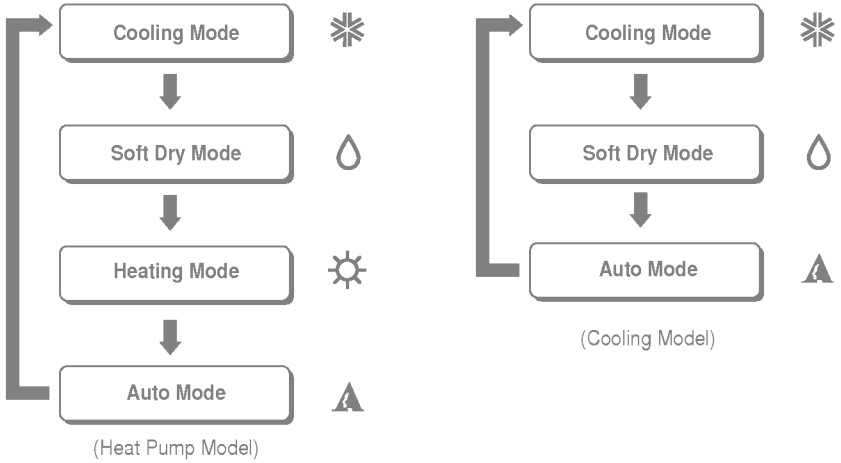

Operation Procedure

1st On/Off Button

2nd Operation Mode Selection Button

3rd Room Temperature Setting Button

4th Indoor Fan Speed Selection Button

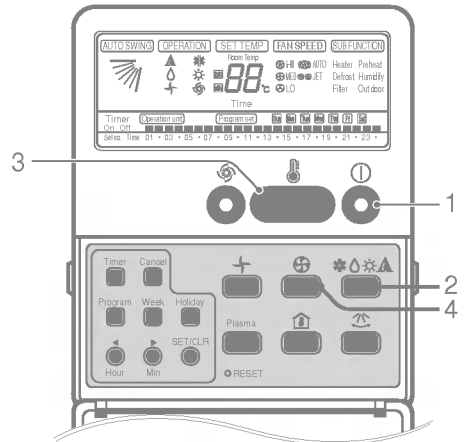

I Cooling Operation Mode

1 Press the On/Off Button.



2 Select Cooling Operation.

Press the Operation Mode Selection Button.

Each time the button is pressed, the operation mode is shifted in the arrow direction.

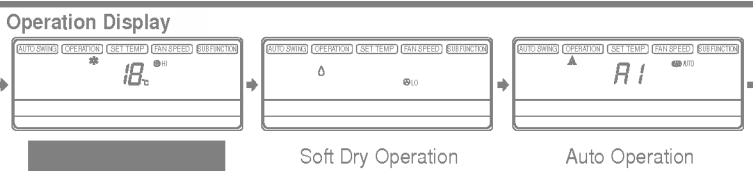
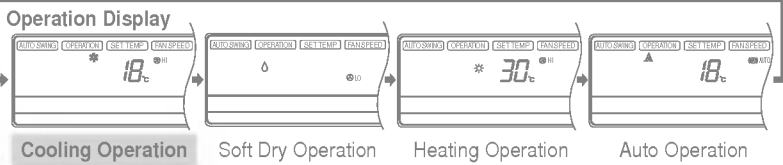

3 Set the temperature lower than the room temperature.

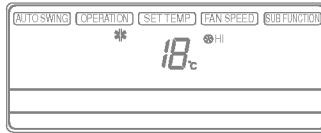

• The temperature can be set within a range of 18°C ~ 30°C by 1°C.

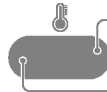

To raise the Temperature.

To lower the Temperature.

4 Set the fan speed.

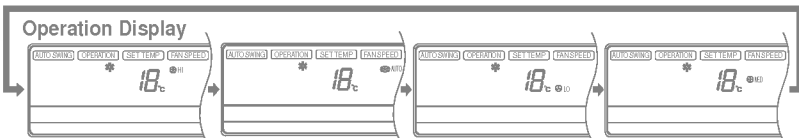

- Select the fan speed in four steps-high, Auto, low, medium.
- The display shows high fan speed.
- Each time the button is pressed, the fan speed mode is shifted.

2 Soft Dry Operation Mode

This mode dehumidifies without overcooling.

- 1** Press the On/Off Button.



- 2** Select Soft Dry Operation.

Press the operation Mode Selection Button.

Each time the button is pressed, the operation mode is shifted in the arrow direction.

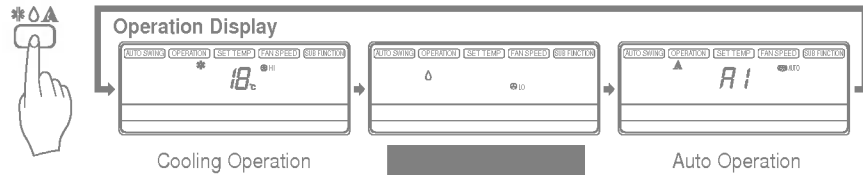
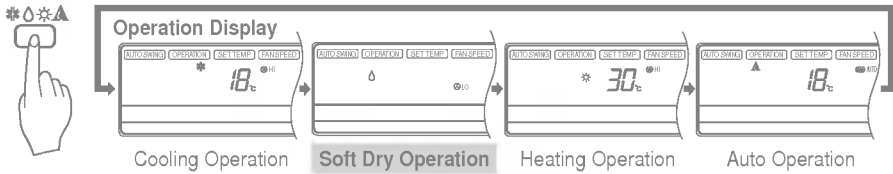

- 3** During Dry Operation.

- The indoor fan speed is automatically set to the low, so the shift of the indoor fan speed is impossible because of already being set to the best speed for Dry Operation by Micom Control.

3 Heating Operation Mode (Heat pump model only)

1 Press the On/Off Button.



2 Select Heating Operation.

Press the Operation Mode Selection Button.

Each time the button is pressed, the operation mode is shifted in the arrow direction.

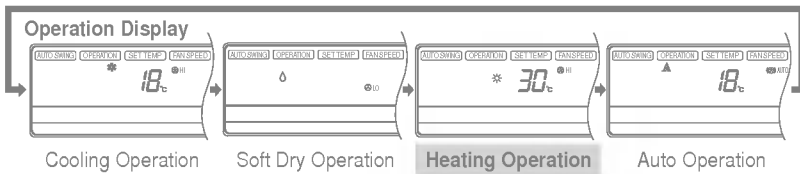

3 Set the temperature higher than the room temperature.

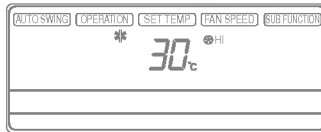

• The temperature can be set within a range of 16°C~30°C by 1°C.

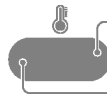

To raise the Temperature.

To lower the Temperature.

4 Set the fan speed.

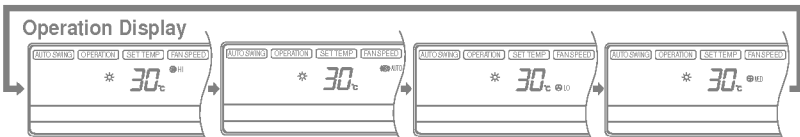

5 This air-conditioner is set to the hot start control in order not to discharge the cold air during the heating operation. This time, the remote controller indicates 'Preheat'.

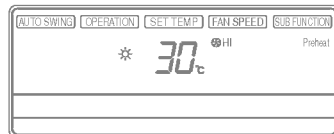

6 If the outdoor temperature is too low during the heating operation, this air-conditioner is set to the defrosting operation and the remote controller indicates 'Defrost'.

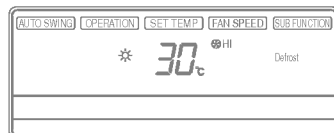

4 Auto Operation Mode (Cooling model)

- 1** Press the On/Off Button.



- 2** To select **Auto Operation**, press the Operation Mode Selection button.
Each time the button is pressed, the operation mode is shifted in the direction of the arrow.

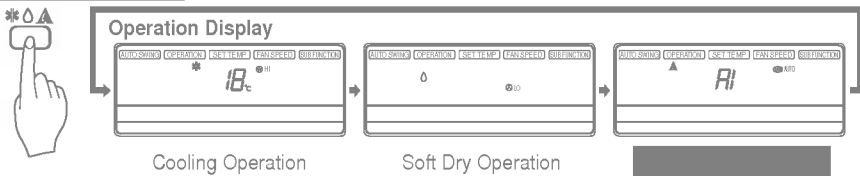

- 3** The temperature and fan speed are automatically set by the electronic controls based on the actual room temperature. If you want to change the set temperature, close the door on the remote control and press the Room Temperature Setting buttons. The cooler or warmer you feel, the more times (up to two times) you should press the button. The set temperature will then be changed. The temperature can be set within a range of -2~2 by 1 level.

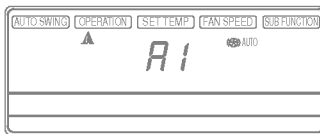

(This indication will be shifted to the initial Auto Mode Display state after 5 seconds.)

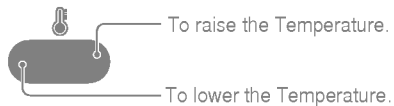

During Auto Operation:

- You cannot switch the indoor fan speed. It has already been set by the Fuzzy rule.
- If the system is not operating as desired, manually switch to another mode. The system will not automatically switch from the cooling mode to the heating mode, or from heating to cooling, it must be done by manually resetting.
- During Auto Operation, pressing the chaos swing button makes the horizontal louvers swing up and down automatically. If you want to stop auto-swing, press the chaos swing button again.

5 Auto Operation Mode (Heat pump model)

1 Press the On/Off Button.



2 To select **Auto Operation**, press the Operation Mode Selection button. Each time the button is pressed, the operation mode is shifted in the direction of the arrow.

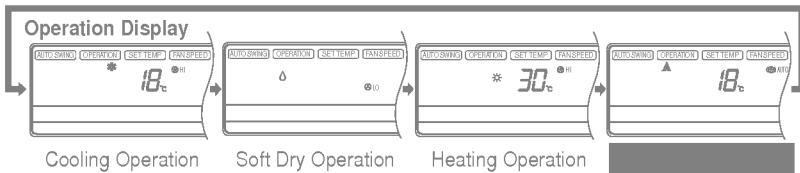

3 The setting temperature can be changed, when the set temperature button is pressed.

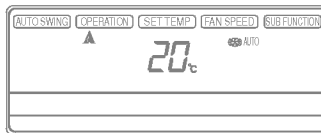

• The temperature can be set within a range of 18°C~30°C by 1°C.



To raise the Temperature.

To lower the Temperature.

During Auto Operation:

- You can switch the indoor fan speed.
- The system will automatically switch from the cooling mode to the heating mode, or from heating to cooling, when you select Auto Operation mode.

6 FAN Operation Mode

1 Press the On/Off Button.



2 Press FAN Operation Button.



3 Each time Fan Speed button is pressed, the fan speed mode is shifted in the arrow direction.

• Fan speed is high.



• Fan speed is medium.

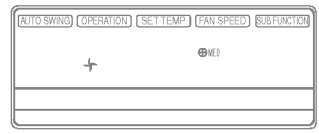

• Fan speed is low.

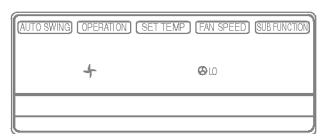

7 Jet Cool Operation Mode

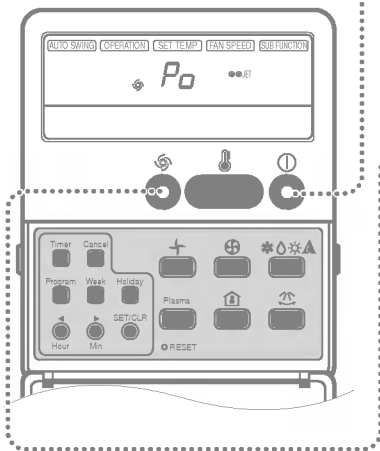

1

Press the On/Off button.
The unit will respond with a beep.



2

Press the **Jet Cool** button to operate the speed cooling mode and the unit will operate in super high fan speed on cooling mode.



3

To cancel the **Jet Cool** mode, press the **Jet Cool** button again or the **Fan Speed** button or the **room Set Temperature** button and the unit will operate in high fan speed on cooling mode.



NOTE:

- During the Jet Cool function at any moment, the A/C starts to blow the cool air at extremely high speed setting the room temp. automatically to 18°C. It is especially used to cool the room temp. in the shortest time in a hot summer.
In heating mode however, the Jet Cool function is not available.
- In order to return to the normal cooling mode from the Jet Cool mode, you just press either the operation mode selection button, airflow volume selection or temp. setting button or the Jet Cool button again.

8 Auto Swing Mode

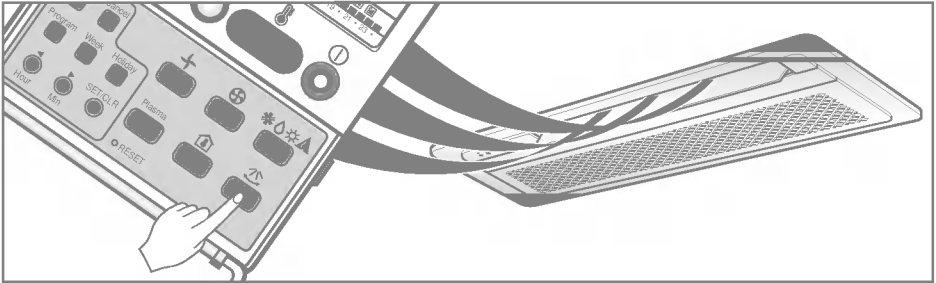

- 1** Press the On/Off button.
(Confirm the unit on operation.)



- 2** Press the Auto Swing button then the horizontal louvers swing up and down automatically.



- 3** Press again the Auto Swing button to cancel the Auto Swing mode.



9 Child Lock Function

This is the Function that any children cannot used to the air-conditioner.

Operation procedure

1 To set the Child-Lock Function

Press the Timer button and Minute Set button for three seconds. Then the operation mode shift to child lock mode and it is displayed 'CL' in the operation display.

When you press any button in this time, the remote controller is not converted to any selected mode and the 'CL' is displayed in the remote controller for about three seconds. But the Room Temperature function is operated in spite of child lock mode.

2 To cancel the Child-Lock Function

Press the Timer button and Minute Set button for three seconds. Then the child-lock mode is cancelled and the preselected mode is displayed in the remote controller.

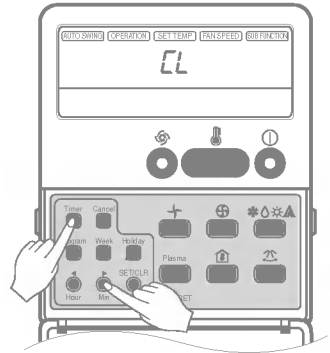

Helpful information

Fan speed and cooling capacity.

The cooling capacity indicated in the specification is the value when the fan speed is set to high, and the capacity will be lower at low or medium fan speed.

High fan speed is recommended when you wish to cool the room quickly.

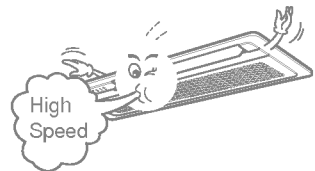

10 Forced Operation

Operation procedures when the remote control can't be used.

Press the tact switch (Forced operation) for 2 seconds.

If you want to stop operation, press again the tact switch.

In case the power comes on again after power failure on the Forced Operation mode, the operating conditions are automatically set as follows:

During Forced Operation, the initial mode continues.

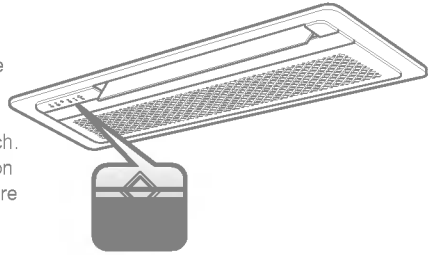

Forced operation
(Tact switch)

	Cooling Model	Heat pump Model	
		Room Temp. \geq set Temp. -2°C	Room Temp. $<$ set Temp. -2°C
Operating mode	Cooling	Cooling	Heating
Indoor FAN Speed	High	set available	set available
Setting Temperature	22°C	set available	set available

11 Auto Restart Function

In case the power comes on again after a power failure, Auto Restarting Operation is the function to operate procedures automatically to the previous operating conditions.

12 Tips for Filter sign LED

- 1 Filter sign lamp(LED) is ON.
- 2 If LED indicating filter sign lamp is ON, clean the filter.
- 3 After cleaning the filter, press the timer button and ◀ button of wired remote controller at the same time for 3 seconds. Then filter sign LED is OFF.

13 PLASMA Purification Operation

This function is available only LT-C1262HL.

- 1 Press the On/Off button. The unit will respond with a beep.
- 2 Open the door on the remote control. Press the PLASMA air purifying operation ON/OFF button. Operation will start when the button is pressed and stop when the button is pressed again.
- 3 Set the fan speed again with door of the remote control closed. You can select the fan speed in four steps-low, medium, high or Auto. Each time the button is pressed, the fan speed mode is shifted.
* Air purifying operation (PLASMA) with cooling, heating or any other operations.

Care and maintenance of the air conditioner

Indoor Unit

Grille, Case and Remote Control

- Turn the system off before cleaning. To clean, wipe with a soft, dry cloth. Do not use bleach or abrasives.

NOTE:

Supply power must be disconnected before cleaning the indoor unit.

Air Filters

The air filters behind the front grille should be checked and cleaned once every 2 weeks or more often if necessary.

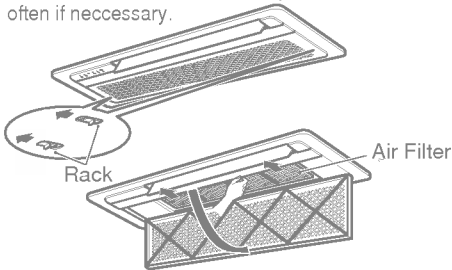

- Never use any of the followings:
 - Water hotter than 40°C. Could cause deformation and/or discoloration.
 - Volatile substances. Could damage the surfaces of the air conditioner.

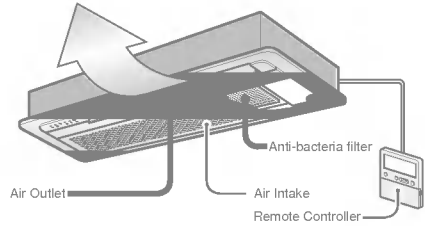

- 1 **Remove the Air filters.**
 - Take hold of the tab and pull slightly forward to remove the filter.



CAUTION

When the air filter is to be removed, do not touch the metal parts of the indoor unit.

It may cause an injury.

- 2 **Clean dirt from the air filter using a vacuum cleaner or washing with water.**
 - If dirt is conspicuous, wash with a neutral detergent in lukewarm water.
 - If hot water (50°C or more) is used, it may be deformed.
- 3 **After washing with water, dry well in the shade.**
 - Do not expose the air filter to direct sunlight or heat from a fire when drying it.
- 4 **Install the air filter.**

Outdoor Unit

The heat exchanger coils and panel vents of the outdoor unit should be checked regularly. If clogged with dirt or soot, the heat exchanger and panel vents may be professionally steam cleaned.

NOTE:

Dirty or clogged coils will reduce the operating efficiency of the system and cause higher operating costs.

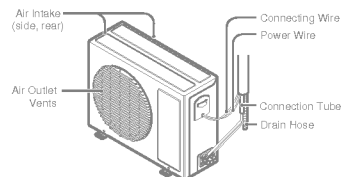

Purifying filter(For 2HL Model only)

Cleaning

The PLASMA filter behind the air filters should be checked and cleaned once every 3 months or more often if necessary.

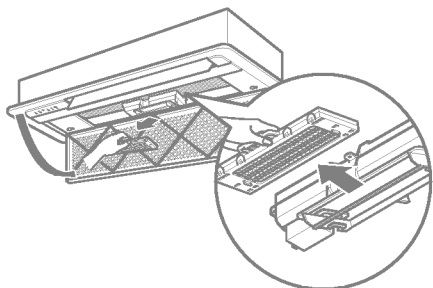

- After removing the air filters, pull slightly forward to remove the PLASMA filter.
- Dip the PLASMA filter into the water mixed with neutral detergent, for 20~30 minutes.
- Dry the PLASMA filter in the shade for a day (Especially, the humidity must be removed perfectly on this parts).
- Note the cuts of electric discharge lines.
- Re-install the PLASMA filter to the original position.



Don't touch this PLASMA Filter within 10 seconds after opening the inlet grille, it may cause an electric shock.

Replacement

• Recommended use period : About 2 years

- Open front panel and remove air filter.

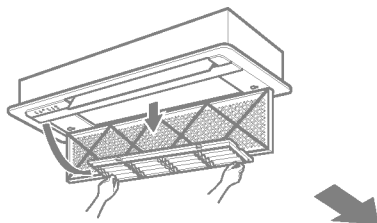

- Reinsert air filter and close front panel.

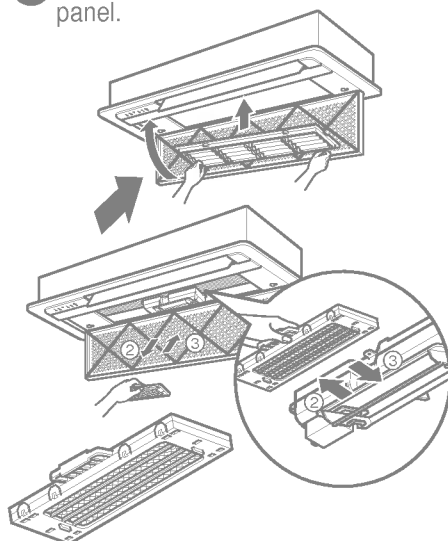

- Remove air purifying filter.
- Insert new air purifying filter.

When the air conditioner is not GOING to be used for a long time.

- 1 Operate the air conditioner at the following settings for 2 to 3 hours.
 - Type of operation: Fan operation mode.(Refer to page 16.)
 - This will dry out the internal mechanisms.

- 2 Turn off the breaker.

CAUTION

Turn off the breaker when the air conditioner is not going to be used for a long time.

Dirt may collect and may cause a fire.

Helpful information

The air filters and your electric bill.
If the air filters become clogged with dust, the cooling capacity will drop, and 6% of the electricity used to operate the air conditioner will be wasted.

- 1 Clean the air filter and install it in the indoor unit.
(Refer to page 20 for cleaning it.)

- 2 Check that the air inlet and outlet of the indoor/outdoor unit are not blocked.

- 3 Check that the ground wire is connected correctly. It may be connect to the indoor unit side.

This is not good for the health and wastes electricity.

Avoid opening doors and windows as much as possible to keep the cool air in the room.

Do not let direct sunshine enter the room when the air conditioner is in operation.

Blockages in the air filter reduce the airflow and lower cooling and dehumidifying effects. Clean at least once every two weeks.

Adjust the vertical and horizontal airflow direction to ensure a uniform temperature in the room.

Since windows are kept closed, it is a good idea to open them and ventilate the room now and then.

Before you call for service...



Troubleshooting Tips! Save time and money!

Check the following points before requesting repairs or service.... If the malfunction persist, please contact your dealer.

<p>The air conditioner does not start.</p> <ul style="list-style-type: none"> • Have you made a mistake in timer operation? • Has the fuse blown or has the circuit breaker been tripped? 	<p>The room has a damp smell.</p> <ul style="list-style-type: none"> • Check that this is not a damp smell exuded by the walls, carpet, furniture or cloth items in the room. 	<p>It seems to be noisy.</p> <ul style="list-style-type: none"> • Condensation occurs when the airflow from the air conditioner cools the warm room air. 	<p>Air conditioning does not start after the power is cut off.</p> <ul style="list-style-type: none"> • This is the protector of the mechanism. • Wait about three minutes and operation will begin.
<p>Does not cool properly.</p> <ul style="list-style-type: none"> • Is the air filter dirty? See air filter cleaning instructions. • The room may have been very hot when the room air conditioner was first turned on. Allow time for it to cool down. • Has the temperature been set incorrectly? • Are the indoor unit's air inlet or outlet vents obstructed? 	<p>The indoor unit is noisy.</p> <ul style="list-style-type: none"> • For a noise that sounds like water flowing. <ul style="list-style-type: none"> -This is the sound of freon flowing inside the air conditioner unit. • For a noise that sounds like the compressed air releasing into atmosphere. <ul style="list-style-type: none"> -This is the sound of the dehumidifying water being processed inside the air conditioning unit. 	<p>Clicking noise.</p> <ul style="list-style-type: none"> • This sound is generated by the expansion/ constriction of the front panel, etc. due to changes of temperature. <p>Filtering noise.</p> <ul style="list-style-type: none"> • Cleaning the filter, press the Timer button and ◀ button of wired remote controller at the same time for 3 sec. 	<p>Remote control does not work.</p> <ul style="list-style-type: none"> • Are the batteries depleted? • Are the batteries inserted in the opposite (+) and (-) directions?

Memo

A large rectangular area with rounded corners, containing 25 horizontal dashed lines for writing.

