

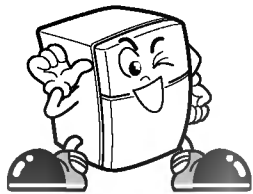

CONTENTS

INSTALLATION	3
FEATURE CHART	4
OPERATIONS	5
ADVICE ON FOOD STORAGE	6
CARE AND CLEANING	7
LAMP REPLACEMENT(Option)	8
IMPORTANT WARNINGS	8
REPOSITIONING THE DOOR HINGE	9
BEFORE CALLING FOR SERVICE	10





THIS REFRIGERATOR IS MANUFACTURED WITH GREAT CARE, AND UTILIZES THE LATEST IN TECHNOLOGY.
WE ARE CONFIDENT THAT YOU WILL BE FULLY SATISFIED WITH IT'S PERFORMANCE AND RELIABILITY.
BEFORE YOU START YOUR REFRIGERATOR, PLEASE READ THIS BOOKLET CAREFULLY. IT PROVIDES EXACT INSTRUCTIONS FOR INSTALLATION, OPERATION AND MAINTENANCE, AND ALSO SUPPLIES SOME USEFUL HINTS.

INSTALLATION

1. Place your refrigerator at a convenient location.
2. Avoid placing the refrigerator near any heat sources, direct sunlight or moisture.
3. Air must circulate properly around your refrigerator to ensure efficient operation. Allow at least a clearance of 10 inches(25cm) or more above the refrigerator and 2 inches(5cm) or more space at rear and both sides.
4. To avoid vibrations the refrigerator has to be placed on a levelled surface. If necessary, set the leveling screws to compensate for unevenness of the floor. The front should be slightly higher than the rear so the door would close more easily.
5. Clean your refrigerator thoroughly and wipe off all dust accumulated during transportation.
6. Connect the power supply cord to the outlet. Don't plug other appliances to the same outlet.
7. Leave your refrigerator on for an hour or so. And check the flow of cold air in the freezer compartment. Your refrigerator is now ready for use.

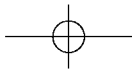



FEATURE CHART

Evaporator: Never use any sharp instruments to remove ice or frost. This may puncture the evaporator.

Ice Tray

Refrigerator shelves

Crisper or P.V.C Bar (Optional): For fruits and vegetables.

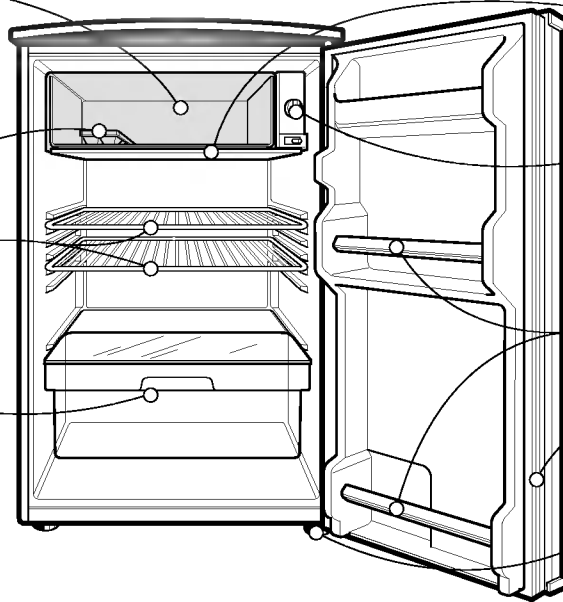

Drip Tray: Collects water that drips off the evaporator when defrosting.

Temperature control Dial.

Refrigerator Door Rack

Magnetic Door Seal

Leveling Screw



OPERATION

STARTING

When your refrigerator is first installed, leave it for 2 or 3 hours for stabilization to normal operating temperature before filling it with food.

Delay 5 minutes before restarting if operation has been interrupted.

TEMPERATURE CONTROL

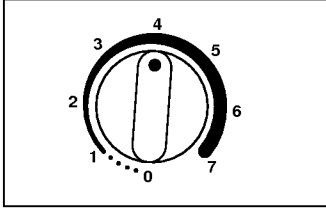

Initially, set the refrigerator compartment control at '4'.

If you wish a colder temperature, set the desired compartment control to a higher number.

ICE MAKING

- To make ice cubes, fill the ice tray with water and place it on the evaporator.
- To remove ice cubes, gently twist the tray while holding it at its ends.

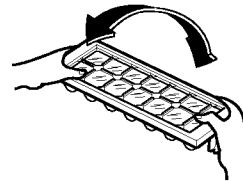

OPERATION

DEFROSTING

- It is necessary to regularly defrost your refrigerator in order to ensure efficient operation.
- As soon as the thickness of ice/frost on the surface of the evaporator reaches a quarter of an inch(6mm), start the defrosting operation.
- To defrost, turn the control to "0".
- Before you start the defrosting operation, remove food from the evaporator and place the drip tray in its proper position.
- When defrosting is completed, remove the drip tray, empty water, dry and put it back to its normal position. Turn the control dial to desired position.



Never use any sharp or metallic instruments to remove ice, frost or ice tray from the evaporator.

ADVICE ON FOOD STORAGE

- Never store hot food in the refrigerator. Always wait until cooled off.
- When storing, cover food with vinyl wrap or store in a container with lid. When moisture in the food evaporates, taste and nutrition of the food disappear as well.
- Never place bottles on the evaporator. They may break while freezing.
- Never refreeze food that has been thawed after being frozen. This would cause the taste and nutrition to disappear.
- Clean food before you store it, so that adjacent food will not be spoiled.

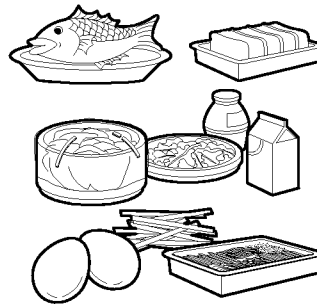



CARE AND CLEANING

CLEANING - INSIDE

To clean the inside, use a soft cloth dampened with solution of a tablespoon of baking soda to a quarter of water, or some mild detergent.

This solution both cleans and neutralizes odors. Rinse with water and wipe dry.

Follow the same procedure to clean the interior parts.

CLEANING - OUTSIDE

Use a lukewarm solution of mild soap or detergent to clean the durable finish of your refrigerator. Wipe with a clean, dampened cloth, then dry.

CLEANING - CAUTIONS

- Always remove the power cord from the electrical outlet before cleaning near electrical parts.
- Never use flammable or toxic cleaning liquids.
- Do not use metallic scouring pads, brushes, coarse abrasive cleaners or strong alkaline solutions on any surface of the refrigerator.
- When you leave for vacation:
 - For extended vacations, disconnect the power cord and leave the door open. This will prevent odors.
 - For shorter vacations, remove perishable foods. Leave the control to normal operation.
- When moving:
 - Secure all loose items by taping them in place to prevent from being damaged, and raise the leveling screw.

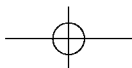
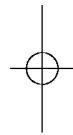

LAMP REPLACEMENT(OPTION)

1. Unplug the power cord from the outlet.
2. Remove refrigerator shelves.
3. Remove the lamp by turning it counterclockwise as shown in the figure at right.
4. Assemble in reverse order of disassembly. Replacement bulb must be the same specification as original.

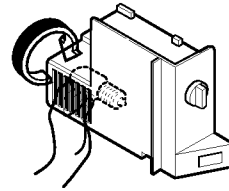

IMPORTANT WARNINGS

DO NOT USE AN EXTENSION CORD

If possible, connect the refrigerator to its own individual electrical outlet in order to avoid an overload caused by other appliances or household lights that might interrupt the electrical current.

An empty refrigerator constitutes a very dangerous attraction to children. Do not forget to remove the door from unused refrigerator.

ACCESSIBILITY OF SUPPLY PLUG

The refrigerator-freezer should be so positioned that the supply plug is accessible for quick disconnection when accident happens.

SUPPLY CORD REPLACEMENT

If the supply cord is damaged, it must be replaced by the manufacturer or its service agent or a similarly qualified person in order to avoid a hazard.

ABOUT GROUNDING(EARTHING)

Grounding(earthing) reduces the risk of electric shock by providing an escape wire for the electric current in case of an electric short circuit.

Improper use of the grounding plug may cause an electric shock. Check with a qualified electrician or a service person if the grounding instructions are not understood, or if you have doubts on whether the appliance is properly grounded.

CAUTION: THIS APPLIANCE MUST BE GROUNDED.

Do not store inflammable materials, explosives or chemicals in the refrigerator.

Do not touch the frozen surface, especially if your hands are wet or damp. It may cause frostbite.

REPOSITIONING THE DOOR HINGE

Your refrigerator is designed with a reversible door so that it may open from either left or right. It is best to reposition the door hinge as necessary at the outset since it is inconvenient to do so later.

To change the door hinge please refer to the diagram below and proceed as follows:—

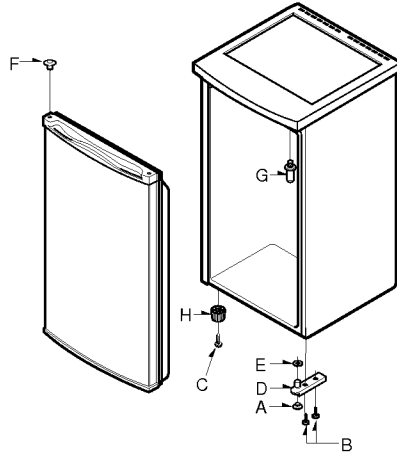

1. Remove all loose fittings from inside the appliance.
2. Carefully lay the appliance on its back on the original packing (You will need assistance to achieve this). Take care not to damage the pipework by keeping it clear of the floor.
3. Unscrew and remove the Adjustable Foot (A).
4. Remove the Lower Hinge (D) by unscrewing the 2xBolts (B).
5. Remove the Leg (H) by unscrewing the bolt fixing it (C).
6. Gently pull the door downwards to remove it.
7. Before refitting the door, swap the Hinge Cap (F) by prising it from its current location and repositioning it on the other side of the door. Care should be taken not to damage the adjacent surfaces when removing the Hinge Cap.
8. Unscrew the Upper Hinge pin (G) and screw it into the opposite side hole in the top of the cabinet.
9. Now secure the Lower Hinge (D) to the cabinet using the 2xBolts (B).
10. Replace the Adjustable Foot (A), setting it at approximately 20mm.
11. Carefully stand the appliance up, (you will need assistance to do this), and position it in its permanent location.
12. Check that the door opens and closes easily. Ensure that the door seal does not bind on the hinge side creating gaps which would allow air into the interior. Adjust the hinges if necessary.

This appliance should be stood on a firm, level floor with sufficient space for free airflow around it. (At least 10mm all round and, subject to location, 20mm beneath the worksurface). Avoid positions close to walls or corners. There must be sufficient room for free ventilation particularly at the back. The unit should be located away from direct heat sources, such as cookers, radiators and direct sunlight. If the unit is positioned where the temperature is too low, condensation will form on the outside of the cabinet. Normal room temperature is recommended.

Avoid locations which may be affected by draughts or dampness as this will impair the efficiency of the product



BEFORE CALLING FOR SERVICE

IT IS OFTEN POSSIBLE TO AVOID A SERVICE CALL.
BEFORE CALLING FOR SERVICE, MAKE THE FOLLOWING CHECKS.

- Has a house fuse blown or a circuit breaker tripped on?
- Has the power cord plug been removed or loosened from the wall outlet?
- Is the temperature control set to a proper position?
- Is the appliance placed too close to a wall or a heat source?
- Has the door been kept open more than necessary?
- Is the refrigerator installed on a firm and even place?
- In case of odor. Food with strong odor should be tightly covered or wrapped, and interior may need cleaning.

