



## LCD PROJECTION MONITOR

Please read this manual carefully before operating your set.

Retain it for future reference.

Record model number and serial number of the set. See the label attached on the back of the set and quote this information to your dealer when you require service.

Model number :  
Serial number :



# LCD PROJECTION MONITOR

## Warning

This is a class B product. In a domestic environment this product may cause radio interference, in which case the user may be required to take adequate measures.

## FCC NOTICE

### • A Class B digital device

This equipment has been tested and found to comply with the limits for a Class B digital device, pursuant to Part 15 of the FCC Rules. These limits are designed to provide reasonable protection against harmful interference in a residential installation. This equipment generates, uses and can radiate radio frequency energy and, if not installed and used in accordance with the instructions, may cause harmful interference to radio communications. However, there is no guarantee that interference will not occur in a particular installation. If this equipment does cause harmful interference to radio or television reception, which can be determined by turning the equipment off and on, the user is encouraged to try to correct the interference by one or more of the following measures:

- Reorient or relocate the receiving antenna.
- Increase the separation between the equipment and receiver.
- Connect the equipment into an outlet on a circuit different from that to which the receiver is connected.
- Consult the dealer or an experienced radio/TV technician for help.

- **Any changes or modifications not expressly approved by the party responsible for compliance could void the user's authority to operate the equipment.**

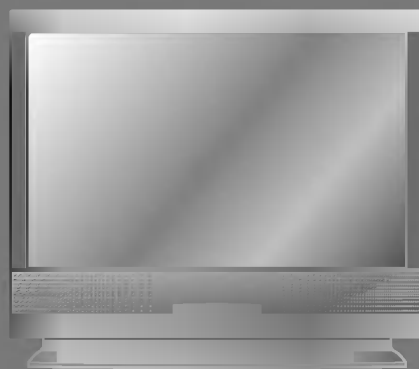

# CONTENTS

---

## INTRODUCTION

Safety Instructions .....	4
Names of parts .....	12

## COMPOSITION

Turning on the Monitor.....	18
Turning off the Monitor.....	19
Selecting source mode .....	20

## CONNECTION

Connecting to a Desktop PC .....	21
Connecting to a Notebook PC .....	22
Connecting to a Macintosh Desktop PC.....	23
Connecting to a Macintosh PowerBook .....	24
Connecting to a Video Source.....	25
Connecting to a DVD.....	26
Connecting to a D-TV Set-Top Box .....	27
Connecting to a MIC.....	28

## BASIC FUNCTIONS

Function checking.....	29
Using Still function .....	30

## SPECIAL FUNCTIONS

Selecting language .....	31
Checking lamp time .....	32
Positioning .....	33
Using Zoom function.....	34
Using ARC function .....	35

## TRACKING

Using Tracking function .....	36
-------------------------------	----

## VIDEO

Adjusting Video.....	38
----------------------	----

## AUDIO

Adjusting Audio .....	40
Using Audio Input function.....	41
Using DASP function .....	42
Using AVL function.....	43

## RS-232C

External control device setup .....	44
-------------------------------------	----

## INFORMATION

Supported Monitor Display .....	50
Specifications .....	51

---

Before operating the unit, please read this manual carefully.

▶ Always keep the safety instructions to prevent any potential accident or misuse of the monitor.

▶ Safety Instructions have two kinds of information, and each meaning of it is as below.

**▲ WARNING** This instruction may cause serious or fatal injuries.

**▲ NOTES** This instruction may cause light personal injuries or damage to the monitor.

▶ After reading this manual, keep it in the place that the user always can contact easily.

### ▲ Indoor Installation-WARNING

Do not place the Monitor in direct sunlight or near heat sources such as radiators, fires and stove etc.

- This may cause a fire hazard !

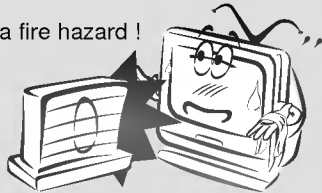

Do not place inflammable materials beside the monitor.

- This may cause a fire hazard !



Do not allow children hang on or climb on the installed monitor.

- This may cause the display to fall, causing a fatal injury.

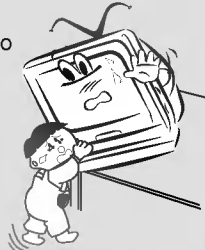

### ▲ Indoor Installation-NOTES

Disconnect from the mains and remove all connections before moving.



Do not place the monitor close to sources of steam or oil such as a humidifier.

- This may create a fire hazard or an electric shock hazard !

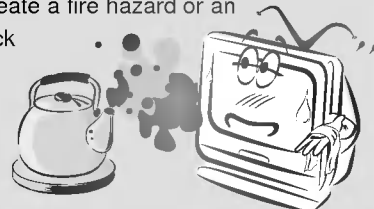

## ▲ Indoor Installation-NOTES

When unpacking or moving the Monitor two people will be necessary to lift it safely.

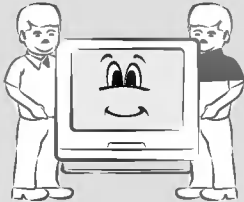

Do not place the monitor where it might be exposed to dust.

- This may cause a fire hazard !



When installing the monitor on a table, be careful not to place it near the edge.

- This may cause the monitor to fall causing serious personal injury and serious damage to the monitor.
- **Be sure to use a suitable table or rack.**

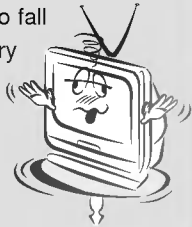

Only use the monitor on a level and stable surface.

- Else it may become unstable and affect correct operation.

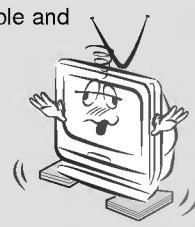

Ensure good ventilation around the monitor. The distance between the monitor and the wall should be more than 10cm.

- Else the internal temperature of the monitor will increase and create a fire hazard.

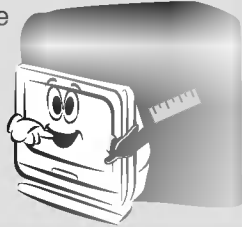

Do not cover the vent grilles of the monitor.

- This may cause a fire hazard !

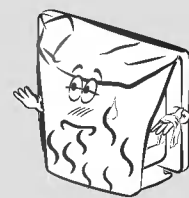

Do not place the monitor directly on a carpet, rug or place where ventilation is restricted.

- This would cause its internal temperature to increase and might create a fire hazard !

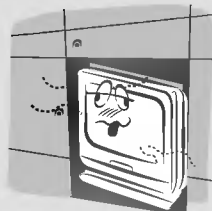

Do not use the monitor in a damp place such as a bathroom where it is likely to get wet.

- This may cause a fire or an electric shock hazard !

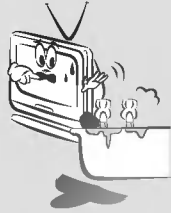

In the case of using a receiver (VCR, Digital Set Top Box), be sure to position the antenna cable between inside and outside of the building to prevent rain from flowing in.

- Else this may cause water damage inside the monitor and create an electric shock hazard.



## ▲ Outdoor Installation-NOTES

In the case of using a receiver (VCR, Digital Set Top Box), do not place an antenna in the vicinity of power lines.

- This may create an electric shock hazard.

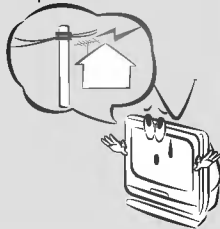

In the case of using a receiver (VCR, Digital Set Top Box), arrange qualified personnel to install an outside antenna.

- This job involves risk of personal injury.

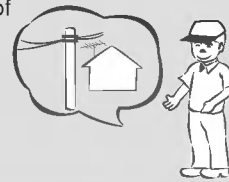

In the case of using a receiver (VCR, Digital Set Top Box), there should be enough distance between an outside antenna and power lines to prevent contact should the antenna fall.

- This may create an electric shock hazard.

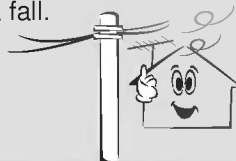

The mains plug should be inserted fully into the power outlet to avoid a fire hazard !

- Else this may cause a fire hazard !



Do not place heavy objects on the power cord

- This may cause a fire or an electric shock hazard !

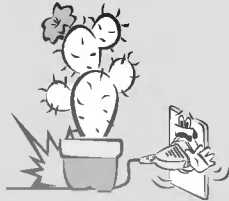

Do not use too many plugs on the Mains multi-outlet.

- It may result in overheating of the outlet and causes a fire hazard !

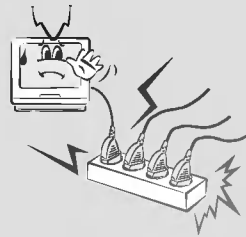

Never touch the power plug with a wet hand

- This may cause an electric shock hazard !

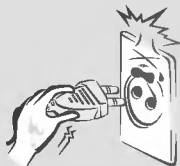

Hold the plug firmly when unplugging. If you pull the cord, the cord may be damaged.

- This may cause a fire hazard !



Do not turn the monitor On/Off by plugging-in or unplugging the power plug from the wall outlet.(Do not use the power plug as a switch.)

- Else this may cause mechanical failure or could create an electric shock or fire hazard.

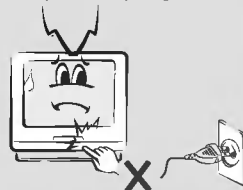

Prevent dust collecting on the power plug pins or outlet.

- This may cause a fire hazard !

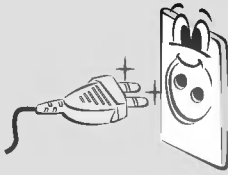

Do not plug when the power cord or the plug is damaged or the connecting part of the power outlet is loose.

- This may cause a fire or an electric shock hazard !



Ensure the power cord does not come into contact with sharp or hot objects such as a heater.

- This may cause a fire or an electric shock hazard !

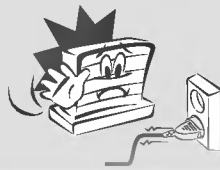

Do not place anything containing liquid on top of the monitor such as flowerpot, cup, cosmetics or candle.

- This may cause a fire hazard !



In case of impact shock or damage to the monitor switch it off and unplug it from the outlet and contact your service center.

- This may cause a fire or an electric shock hazard !

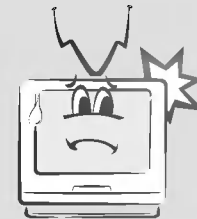



Don't look at laser beam directly as it will cause eye damage.

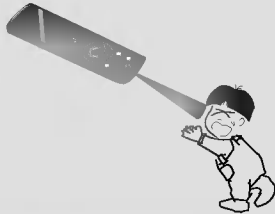

Never touch the wall outlet when there is leakage of gas, open the windows and ventilate.

- It can cause a fire or a burn by a spark.



Do not open the lamp cover because the lamp operates at high pressure and high temperature.

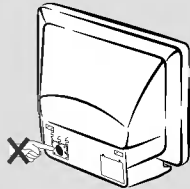

Do not allow any objects to fall into the monitor.

- This may cause an electric shock hazard !

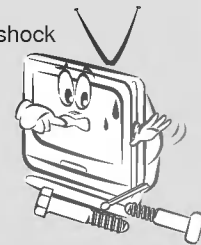

If water is spilt into the monitor unplug it from the main supply outlet immediately and consult your Service Center.

- This may cause an electric shock hazard !

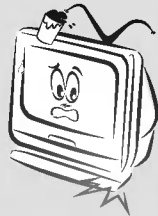

Dispose of used batteries carefully and safely.

- In the case of a battery being swallowed by a child please consult a doctor immediately.

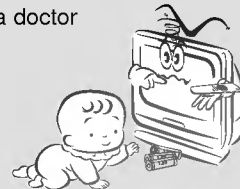

In the event that an image does not appear on the screen please switch it off and unplug it from the main supply and contact your Service Center.

- This may cause a fire or an electric shock hazard !

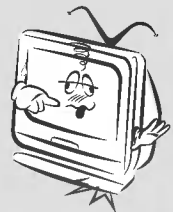

Do not watch the monitor while driving or walking.

- This may cause an accident.



Do not drop the monitor or allow impact shock.

- This may cause mechanical failure or injury !



Do not place heavy objects on the Monitor.

- This may cause serious injury to a child or adult.



Do not use water while cleaning the Monitor.

- Else this may cause damage to the Monitor or create an electric shock hazard.

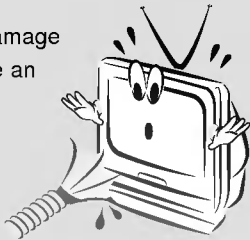

In the unlikely event of smoke or a strange smell from the Monitor, switch it off ,unplug it from the wall outlet and contact your dealer or service centre.

- This may cause a fire or an electric shock hazard !

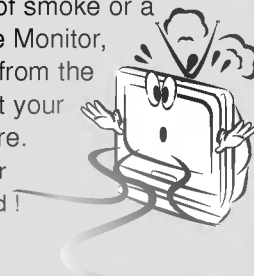

Unplug this product from the wall outlet before cleaning. Do not use liquid cleaners or aerosol cleaners.

- This may cause damage to the Monitor or cause an electric shock hazard !

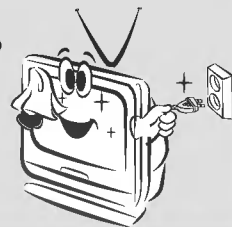

Contact the service center once a year to clean the internal part of the monitor.

- Accumulated dust can cause mechanical failure.

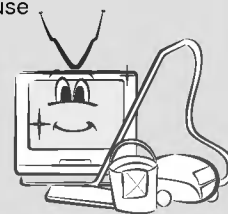

Do not attempt to service the Monitor yourself. Contact your dealer or service centre.

- This may cause damage to the Monitor and could give an electric Shock as well as invalidating the warranty !

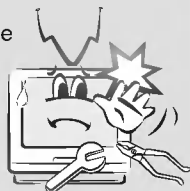

In the event of a lightning or thunder storm unplug the Monitor and aerial from the wall outlet.

- This will prevent damage to the Monitor and possible electric shock.

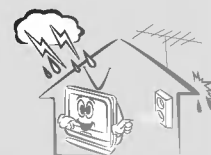

The distance between eyes and the screen should be about 1.5m.

- If not, eyes will strain.

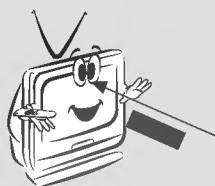

Unplug the Monitor from the wall outlet when it is left unattended and unused for long periods of time.

- Accumulated dust may cause a fire or an electric shock from deterioration or electric leakage.

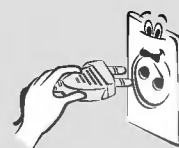

Do not mix new batteries with old batteries.

- This can cause batteries to overheat and leak causing personal injury and damage to the remote control.

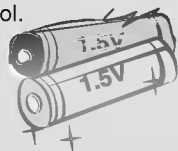

Only use the specified batteries.

- Else this may cause damage to the Remote Control.

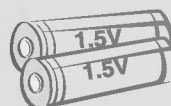

Avoid having a fixed image remain on the screen for a long period time. A frozen still picture from a VCR (or 4:3 aspect ratio) displayed on the screen for prolonged periods of time, will result in a ghost image remaining even when you change the image.

## Main Body

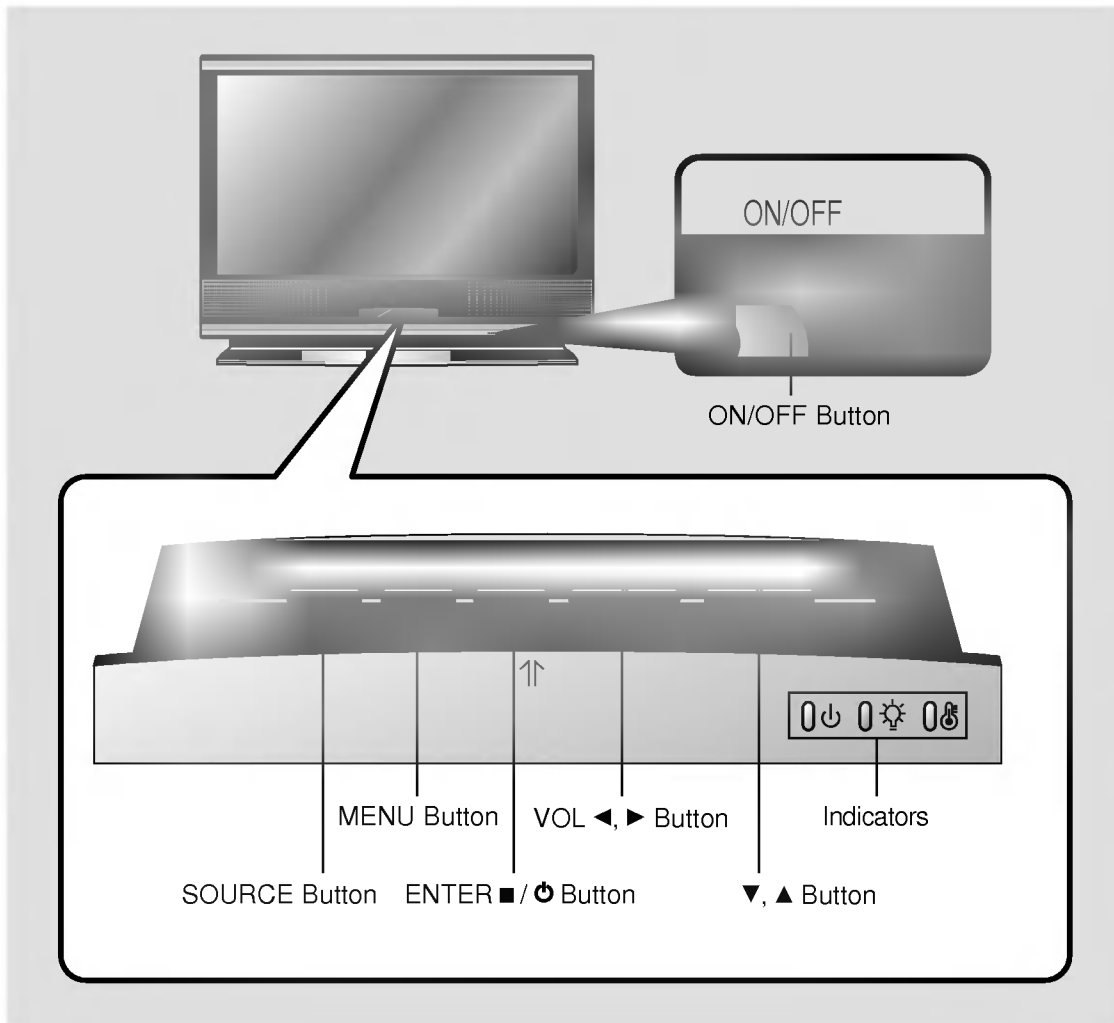

## Rear Connecting Part

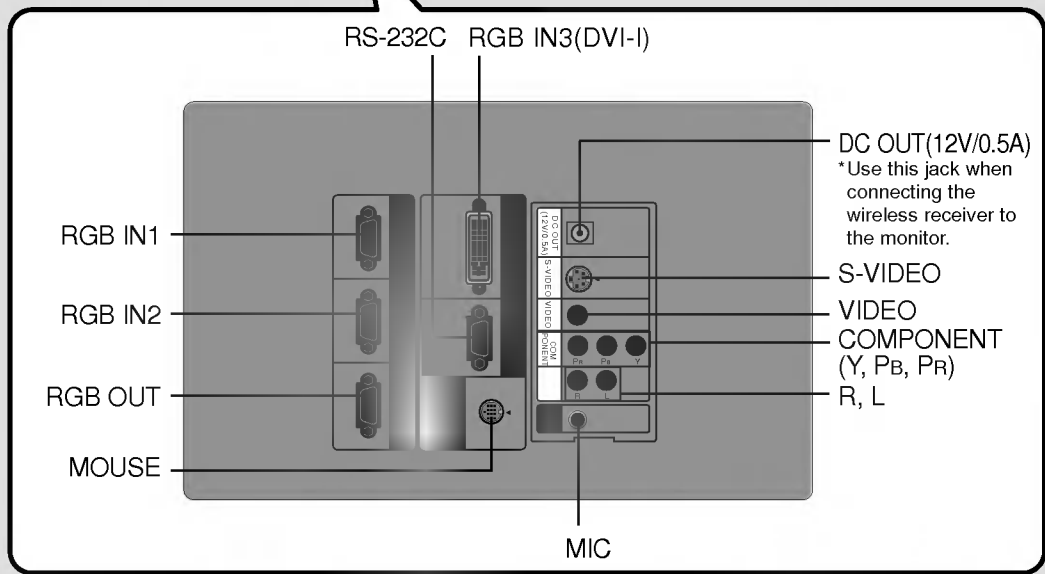
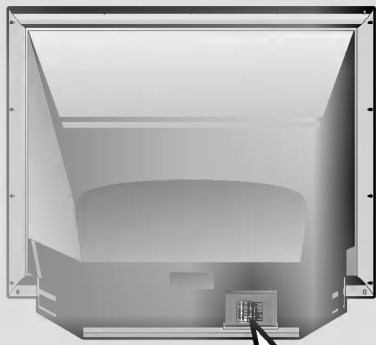

## Remote Control



## Inserting the batteries

- 1** Slide the battery cover in the direction of the arrow to remove.





- 2** Insert the batteries with correct polarity.



- 3** Replace the battery compartment cover to the arrow direction.



## Functions on the Remote Control

Button	Function
POWER Button	Selects ON/OFF of power.
SOURCE Button	Switches to RGB1/2/3, Video, S-Video, Component mode.
MENU Button	Displays or hides the menu.
 MOUSE Button (Zoom-out Button)	* Corresponds to the Left - Click of PC Mouse. * Downsizes the screen on the zoom function.
 MOUSE Button (Zoom-in Button)	* Corresponds to the Right - Click of PC Mouse. * Enlarges the screen size on zoom function.
POINTER Button	* After selecting menus, controls selecting and adjusting functions with the direction of up, down, left, right. * Moves the screen with the direction of up, down, left, right on zoom function. * Moves and releases the selected icon on PC screen.
MOUSE DRAG Button	Uses to select and drag an icon in PC mode.
ENTER  Button	Checks the present mode and sets the change of functions.
ZOOM Button	Refer to page 34.
MUTE Button	Cuts off audio.
VOL.(+, -) Button	Adjusts volume level.
STILL Button	Refer to page 30.
ARC Button	Refer to page 35.
AUTO Button	Refer to page 36.
AVL Button	Refer to page 43.
DASP Button	Refer to page 42.
APC Button	Refer to page 39.
MIC Button	Refer to page 41.
LASER Button	Projects a bright red laser point on to the screen for indication purposes. <b>(Don't look at laser beam directly as it will cause eye damage.)</b>

## Monitor Status Indicators

\* Temperature indicator, lamp Indicator and operation indicator at the front of the monitor show the user the operating status of the monitor.

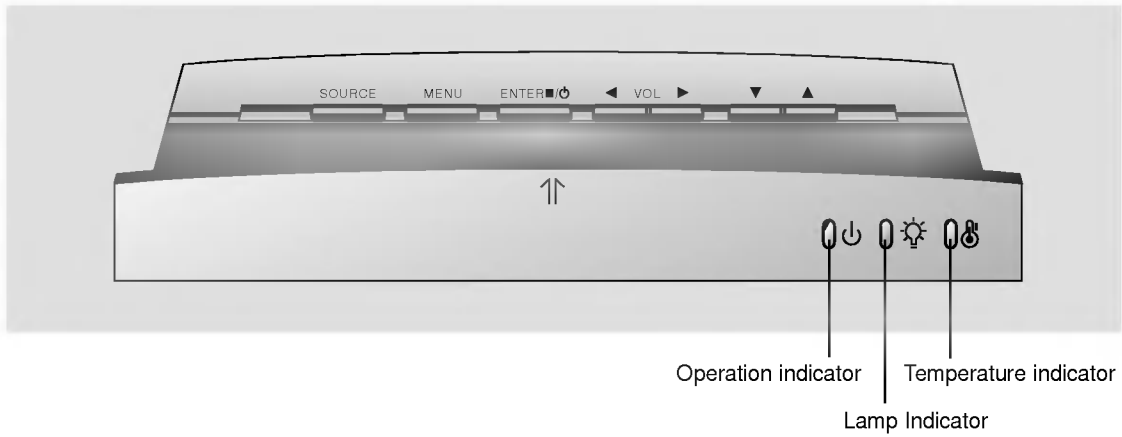

Operation Indicator	Orange	Standby.
	Green(flashing)	Lamp cooling until the lamp turn on. (for 25 seconds)(Refer to P.18)
	Green	On operation.(Turn on the lamp)
	Orange(flashing)	Monitor lamp is cooling as power out(1 minutes)
	Off	Power off.
Lamp Indicator	Red	Monitor lamp is reaching the end of its life and needs to be replaced with a new lamp.(over 10000 hours) "Replace the Lamp"
	Red(flashing)	The monitor has trouble in the lamp or around it. Contact the service center.
	Green(flashing)	The lamp cover is not closed.
Temperature Indicator	Red	The monitor is turned off due to its high temperature. Contact your service center.
	Red(flashing)	Power has turned off due to problem with the internal cooling fans. Contact your service center.
	Green(flashing)	

" " is the warning message on screen.



## Accessories



Remote Control

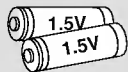

Batteries 2 (size AA)



Audio/Video Cable



DVI cable



Computer Cable



Operating guide

### Mouse Connecting Cables



PS/2 Mouse Cable  
(IBM PC or Compatible)



MAC Serial Mouse Cable

## Optional Extras

- \* Contact your dealer for buying these items.
- \* Contact your dealer for replacing a new lamp.



S-Video Cable

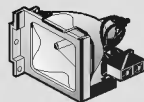

Lamp

---

**1** Connect power cord correctly.

---

**2** Press the **ON/OFF** button on the monitor. At this moment, the monitor is switched to standby mode. Press any button on the keypad or **POWER** button on the remote control then the monitor will be turned on.

---

**3** Adjust volume level.

- If you press **VOL. +** button, volume level number is increased.
- If you press **VOL. -** button, volume level number is decreased.

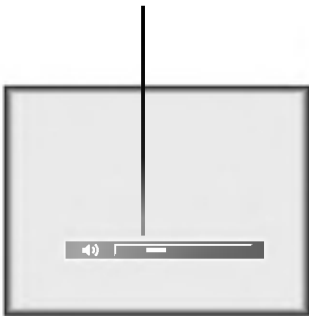

\* Don't turn main power off and don't unplug the power cord while the ventilation fan(inlet/outlet) is working.

- 1** Press the **ENTER** ■ / ⏻ button on the keypad for 3 seconds or **POWER** button on the remote control.

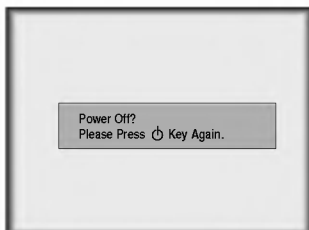

- 
- 2** Press the **ENTER** ■ / ⏻ button or **POWER** button on the remote control again to switch off the power.
- 

- 3** If the operation indicator is flashing(orange), leave the power cord plugged into the outlet. Do not pull out from the outlet until operation indicator is lit up(orange) constantly.
- If operation indicator is flashing(orange), the power button on the top cover or remote control may not operate.

**1** Press the **SOURCE** button



**2** Move the **POINTER** button left or right. Each press of the **POINTER** button changes the display as below.

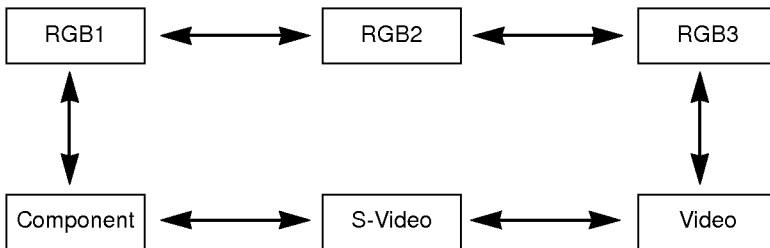

- \* You can connect the monitor to a computer of VGA, SVGA, XGA and SXGA output.
- \* Refer to page 50 for the supported monitor display of this monitor.

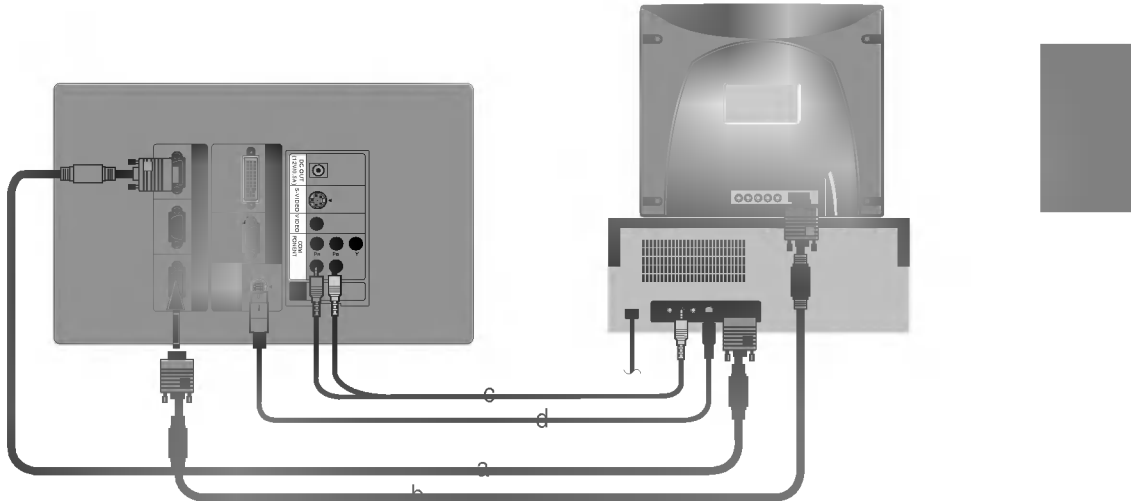

### < How to connect >

- Connect either end of the computer cable to **RGB IN1** or **RGB IN2** of the monitor.  
\* If the PC has DVI output, connect DVI cable to RGB IN3.(RGB IN3 supports DVI-I)
- Connect the monitor cable from the PC monitor to **RGB OUT** of the monitor if you want to also see the monitor image on a PC monitor.
- Connect either end of the audio cable to **R, L** ports of the monitor.  
\* Audio cables are not supplied with the Monitor.
- Connect the PS/2 mouse(for IBM PC or compatible) cable(6 pin) to **MOUSE** of the monitor.

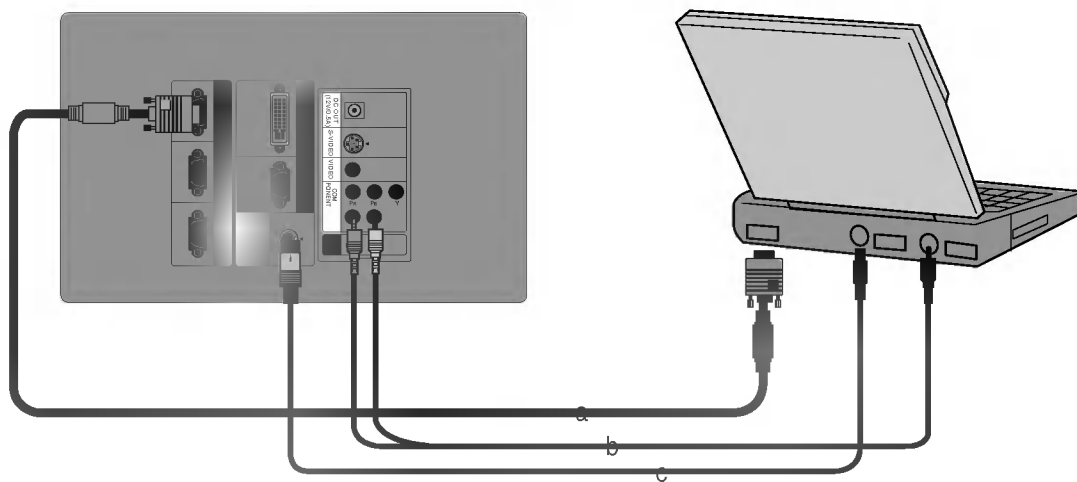

### < How to connect >

- a. Connect either end of the computer cable to **RGB IN1** or **RGB IN2** of the monitor.
  - \* If you set your computer, such as a notebook type IBM PC/AT compatible, to output the signal to both the display of your computer and the external monitor, the picture of the external monitor may not appear properly. IN such cases, set the output mode of your computer to output the signal only to the external monitor. For details, refer to the operating instructions supplied with your computer.
  - \* If the PC has DVI output, connect DVI cable to RGB IN3.(RGB IN3 supports DVI-I)
- b. Connect either end of the audio cable to **R, L** ports of the monitor.
  - \* Audio cables are not supplied with the Monitor.
- c. Connect the PS/2 mouse(for IBM PC or compatible) cable(6 pin) to **MOUSE** of the monitor.
  - \* If the mouse operation is not good, don't use the mouse(Track Ball, Touch Pad, etc) within Notebook PC.

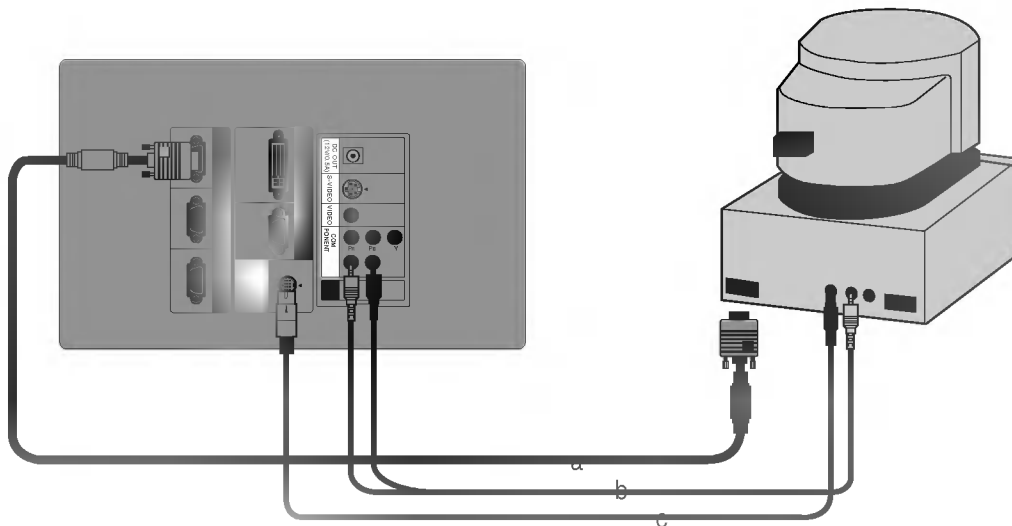

**< How to connect >**

- a. Connect either end of the computer cable to **RGB IN1** or **RGB IN2** of the monitor.
- b. Connect either end of the audio cable to **R, L** ports of the monitor.  
\* Audio cables are not supplied with the Monitor.
- c. Connect the MAC serial mouse cable(4 pin) to **MOUSE** of the monitor.

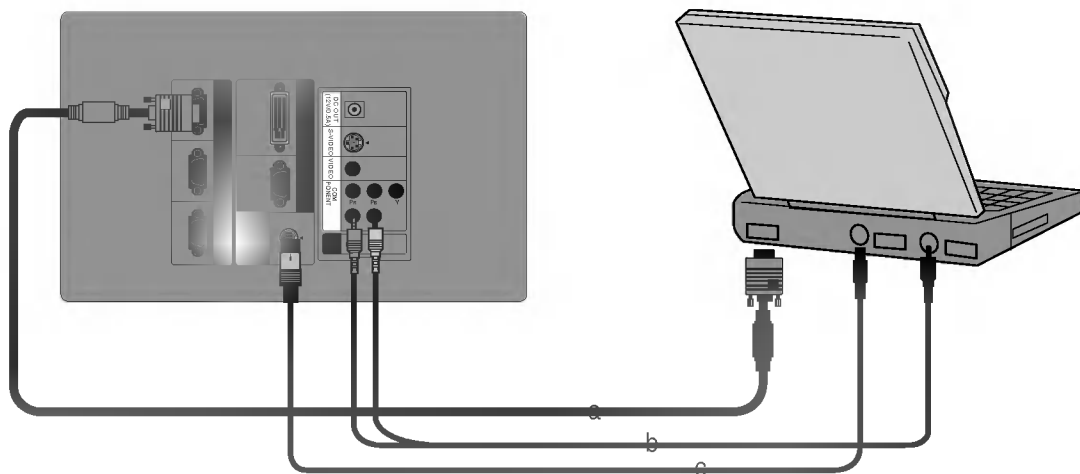

### < How to connect >

- a. Connect either end of the computer cable to **RGB IN1** or **RGB IN2** of the monitor.
- b. Connect either end of the audio cable to **R, L** ports of the monitor.  
\* Audio cables are not supplied with the Monitor.
- c. Connect the MAC serial mouse cable(4 pin) to **MOUSE** of the monitor.



- \* In AV input mode, if the auto video system recognition fails to detect a correct video system type, please press the **AUTO** button on the remote. Then the monitor executes the fine auto video system recognition.
- \* You can connect a VTR, a camcorder, a LDP or any other compatible video image source to the monitor.

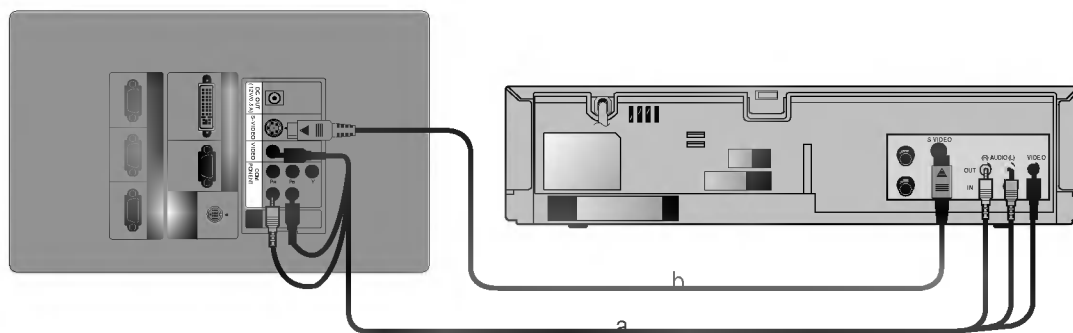

#### < How to connect-In case of connecting Video cable>

- a. When connecting the monitor to an Video source, connect the **VIDEO** input ports of the monitor to the output ports of the Video source with Audio/Video cables of the same color. The video cable is yellow and the left audio is white and right audio is red.

#### < How to connect-In case of connecting S-Video cable>

- b. Connect **S-VIDEO** input port of the monitor to S-Video output port of Video source with S-Video cable.
  - \* You can get better picture quality when connecting S-Video source to the monitor.

\* The output ports (Y, P<sub>B</sub>, P<sub>R</sub>) of the DVD might be inscribed as Y, Pb, Pr / Y, B-Y, R-Y / Y, Cb, Cr according to the equipments.

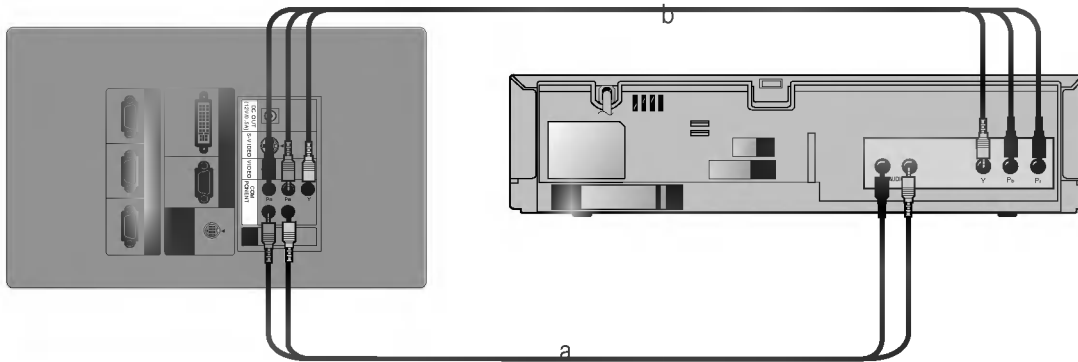

### < How to connect >

- a. Connect the **COMPONENT** ports (Y, P<sub>B</sub>, P<sub>R</sub>) of the monitor to the Video output ports (Y, P<sub>B</sub>, P<sub>R</sub>) of the DVD.
- b. Connect the **R, L** ports of the monitor to the Audio output ports (R, L) of the DVD.  
\* Audio cables are not supplied with the Monitor.

- \* To receive the DTV program, it is necessary to purchase DTV receiver (Set-Top Box) and connect it to the monitor.
- \* Please refer to the owner's manual of the DTV Set-Top Box for the connection to the LCD Projection Monitor.

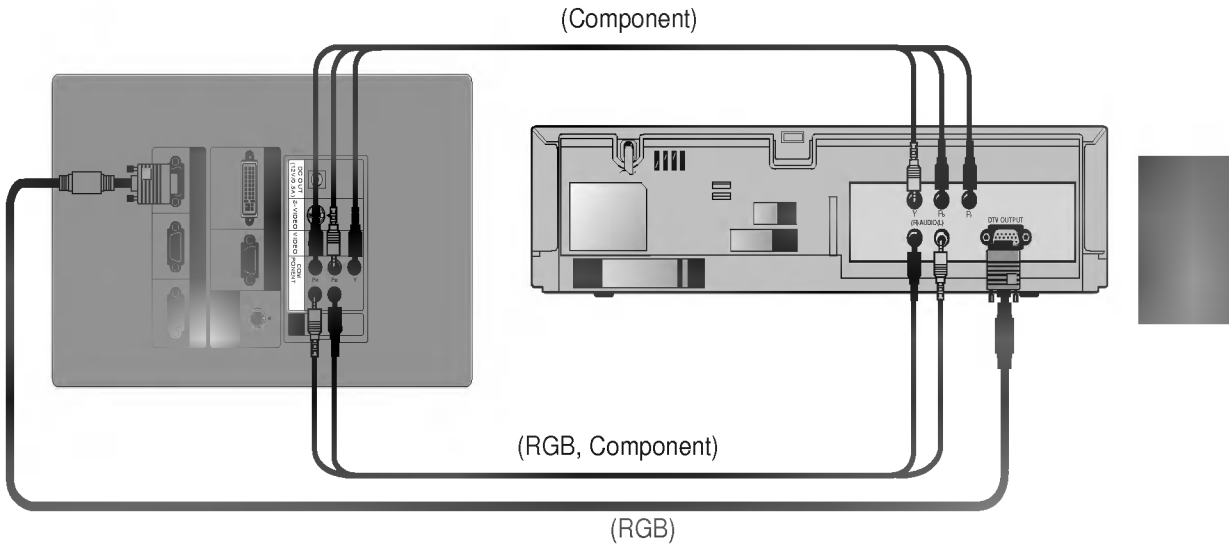

#### < How to connect-In case of connecting RGB>

- a. Connect either end of the computer cable to **RGB IN1** of the monitor.
- b. Connect the **R, L** ports of the monitor to the Audio output ports (**R, L**) of the D-TV Settop Box.  
\* Audio cables are not supplied with the Monitor.
- c. Use a DTV receiver with DTV 720p/1080i mode.

#### < How to connect-In case of connecting Component>

- a. Connect the **COMPONENT** ports (**Y, Pb, Pr**) of the monitor to the Video output ports (**Y, Pb, Pr**) of the D-TV Set-Top Box.
- b. Connect the **R, L** ports of the monitor to the Audio output ports (**R, L**) of the D-TV Set-Top Box.  
\* Audio cables are not supplied with the Monitor.
- c. Use a DTV receiver with DTV 480p/720p/1080i mode.

\* It's impossible to use R/L and MIC simultaneously.



< **How to connect** >

- a. Connect the mike to **MIC** jack of the monitor.
- b. To use the mike, select Audio input **MIC**.(See page 41.)

- \* If there is no input signal, Menu will not display on screen.
- \* This operating guide explains operation of RGB (PC) mode mainly.

**1** Press the **MENU** button.

**2** Move the **POINTER** button up or down to select a menu and press the **ENTER(■)** button. Each time you press the button you can see menus as below.

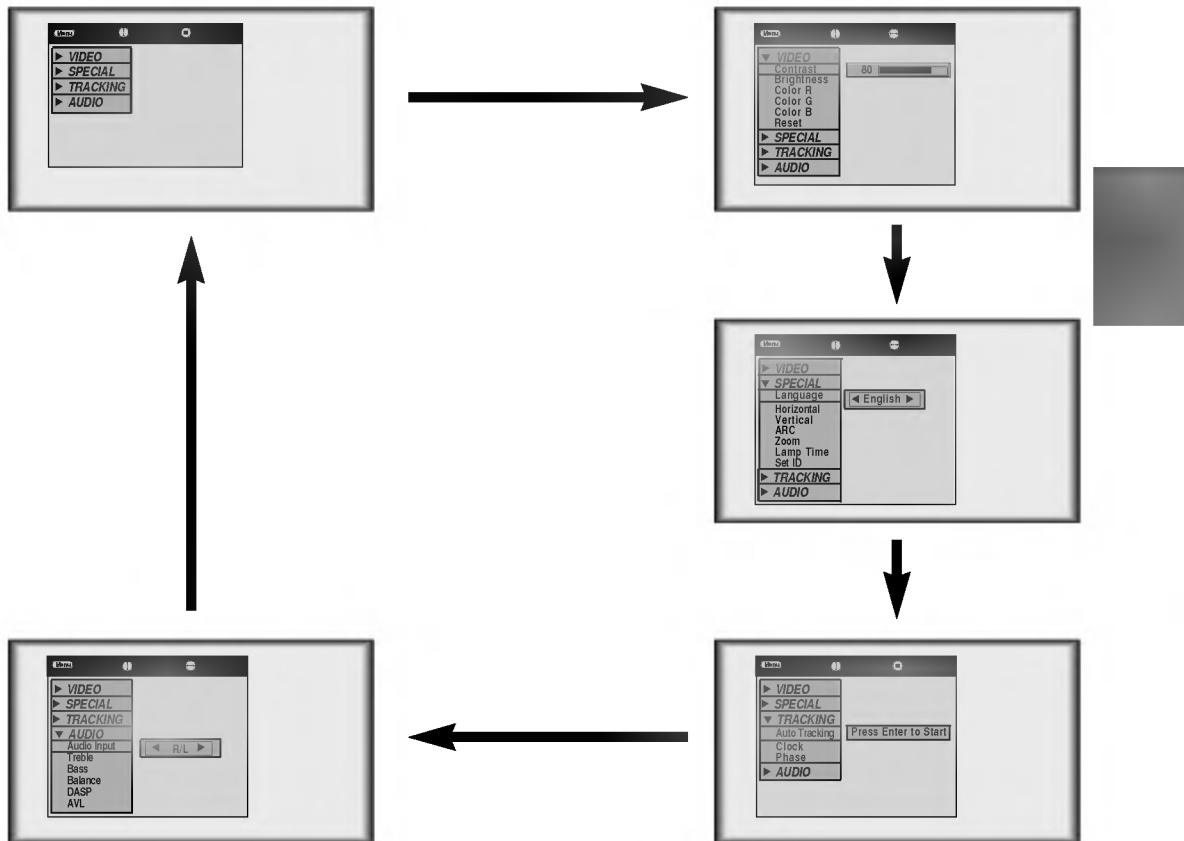

**3** Move the **POINTER** button up or down to select a function that you want to use or adjust.

- To finish the menu display, press the **MENU** button.
- \* In Video and S-Video mode and Component(480i) mode, [**Horizontal**], [**Vertical**] in SPECIAL menu are not displayed.
- \* In Video and S-Video mode and Component(480i, 480p, 720p, 1080i) mode TRACKING menu is not displayed.
- \* The sub menus of VIDEO menu in Video and S-Video mode and Component mode are different from those in the RGB mode. (Refer to page 38).

- 1** Press the **STILL** button.  
\* You can freeze the input image.

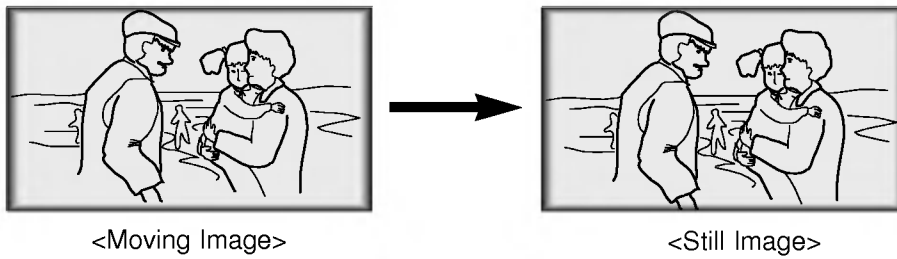

- 
- 2** To finish this function, press the **STILL** button again.  
\* The STILL function would release automatically after about 10 minutes.

- 1** Press the **MENU** button and move the **POINTER** button up or down to select the **SPECIAL** menu as below.



- 2** Press the **ENTER**(**■**) button and move the **POINTER** button up or down to select [**Language**] item.

- 3** Move the **POINTER** button left or right to select the language you want to use.
- On-Screen-Display(OSD) is marked in the selected language from this point.
  - To finish menu display, press the **MENU** button.



- 1** Press the **MENU** button and move the **POINTER** button up or down to select the **SPECIAL** menu as below.

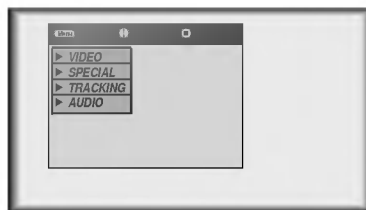

- 2** Press the **ENTER**(■) button and move the **POINTER** button up or down to select the **[Lamp Time]** item.

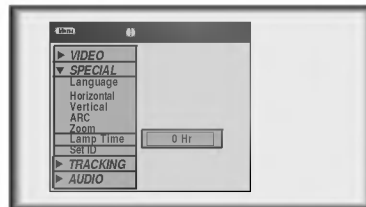

- You can see the used lamp time.
- When monitor lamp is reaching the end of its life(over 10000 hours), the lamp indicator will be turned red and the monitor will display "Replace the Lamp" on screen.



\* If the image size does not fit the screen in accordance with the input source, set the position of the image by selecting Horizontal / Vertical position.

- 1 Press the **MENU** button and move the **POINTER** button up or down to select the **SPECIAL** menu.

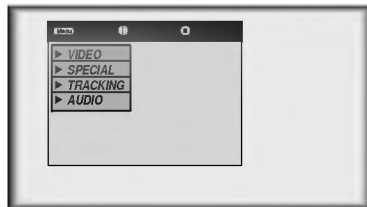

- 2 Press the **ENTER**(■) button and move the **POINTER** button up or down to select [**Horizontal**], [**Vertical**] item.

< RGB mode >

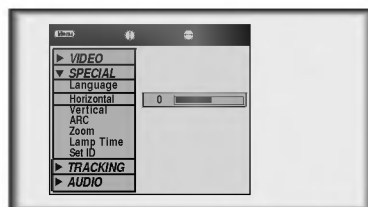

- 3 Press the **POINTER** button and move the button left or right or press the **VOLUME** (+, -) button to adjust the screen condition as you want.

- [**Horizontal**], [**Vertical**] are adjusted from -50 to +50.
- To exit the menu display, press the **MENU** button.

\* This function works only in PC mode.

**1** Press the **ZOOM** button.

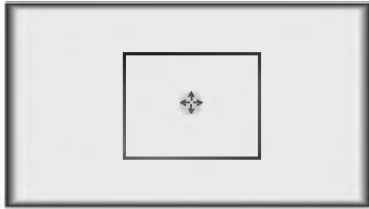

**2** Move the **POINTER** button to move the rectangular zooming area and press the **ENTER** or **ZOOM** button to zoom into the target area.

**3** Press the **⏪** **MOUSE**, **⏩** **MOUSE** button to adjust the zoom level.

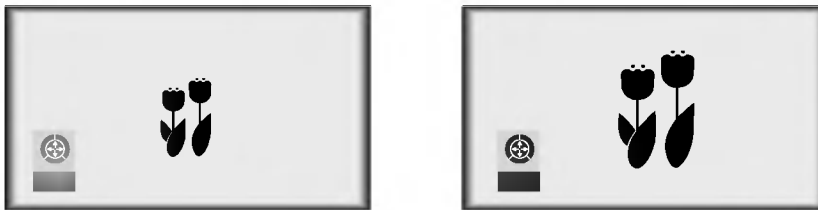

**4** Move to the position you want to see the enlarged screen by moving the **POINTER** button left, right, up, or down.

**5** Press the **ZOOM** or **ARC** or **AUTO** button to finish the zoom function.

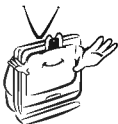

\* This function doesn't work in 720p, 1080i mode.

\* You can use this function by using the **MENU** button.

\* In the zoom mode, you can adjust horizontal / vertical position with the **POINTER** button.

\* With HD input (720p,1080i) mode, you can select 16:9 picture format only.

- 1 Press the **ARC** button.  
Each press of the button changes the display as below.

< RGB(PC) mode >

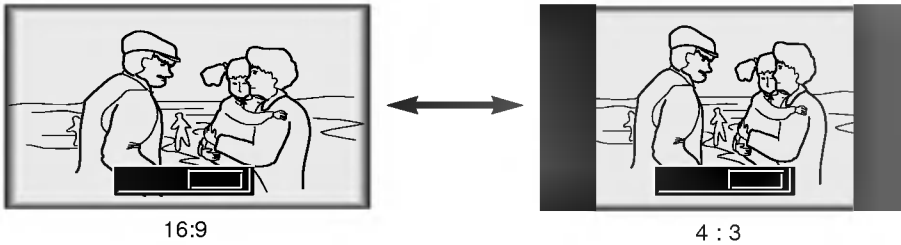

< Video/S-Video/Component mode >

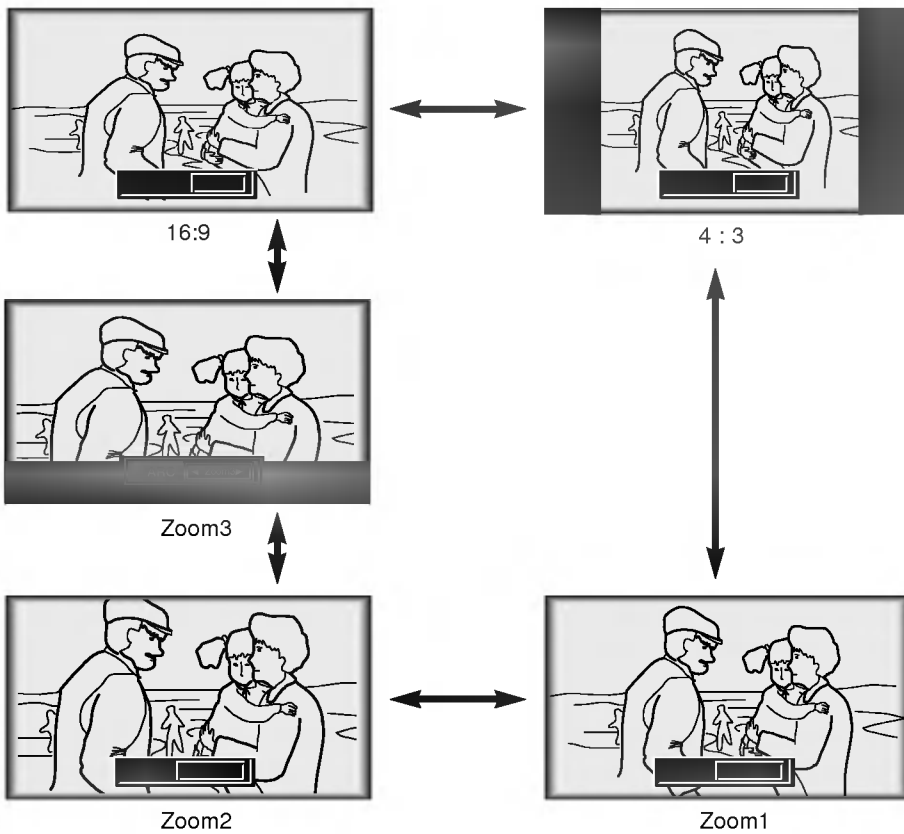

- \* [Zoom2]: Choose when you want to view the center screen with disappearing black bars, with 2.35:1 formatted DVDs.
- \* [Zoom3]: Choose when you want to view the picture with showing little black bar, with 2.35:1 formatted DVDs. Useful for viewing the caption.



\* You can also use this function by using the **MENU** button.

## Auto Tracking Function

### \* Auto Tracking Function

This function assures you of getting the best video quality by automatically adjusting the difference of horizontal size and synchronization of the image.

This function resets system setting if the monitor doesn't recognize the video system in VIDEO mode.

- 1 Press the **AUTO** button.



\* Image positioning and synchronization are automatically adjusted.

- 
- 2 Adjust [**Clock**] or [**Phase**] in TRACKING menu after operation of [**Auto Tracking**] if you want to get better picture quality in accordance with diverse PC input modes. (Refer to page 37.)



- \* You can also use this function by using the **MENU** button. (Only in RGB mode)
- \* For best results perform this function while displaying a still image.

## Clock / Phase Function

### \* Clock Function

This function adjusts the horizontal width of the projected image to get the image to fit on the screen size.

### \* Phase Function

This function is for the detailed adjustment of the clock function.

\* It's available to adjust [Clock], [Phase] in Analog RGB mode only.

- 1 Press the **MENU** button and move the **POINTER** button up or down to select the TRACKING menu.



- 2 Press the **ENTER** (■) button and move the **POINTER** button up or down to select the [Clock] or [Phase] item.

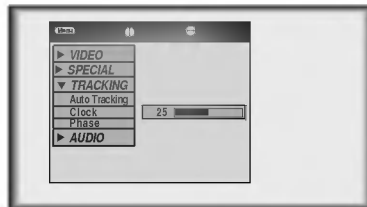

- 3 Move the **POINTER** button left or right or press the **VOLUME** (+, -) button to adjust the screen condition.

- To exit the menu display, press the **MENU** button.

**1** Press the **MENU** button and move the **POINTER** button up or down to select each VIDEO menu.

< RGB mode >



< Video, S-Video, Component mode >



**2** Press the **ENTER**(**■**) button.

< RGB mode >

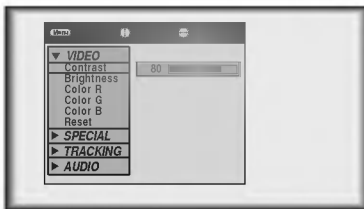

< Video, S-Video, Component mode >

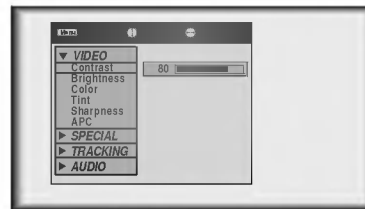

**3** Move the **POINTER** button up or down to select a video item you want to adjust.

**4** Move the **POINTER** button left or right or press the **VOLUME** (+, -) button to adjust the selected video item as you want.

- To restore the original image condition after changing it, press **ENTER** button after selecting **[Reset]** item(Only in RGB mode).
- To finish menu display, press the **MENU** button.

## APC (Auto Picture Control)

- \* Use APC to set the monitor for the best picture appearance.
- \* This function doesn't work in RGB (PC) mode.

**1** Press the **APC** button.



**2** Each press of the **APC** button changes the screen as shown below.

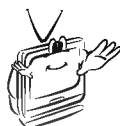
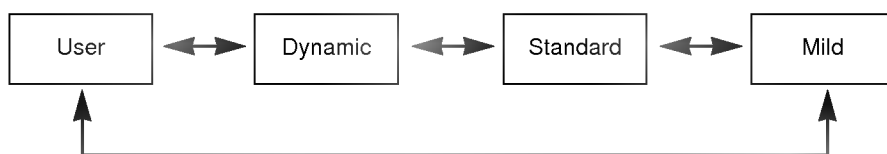

\* You can also use this function by using the **MENU** button.  
(Video/S-Video/Component mode)

- 1** Press the **MENU** button and move the **POINTER** button up or down to select each AUDIO menu.

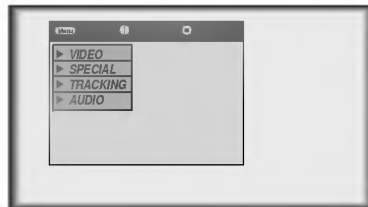

- 2** Press the **ENTER**(**■**) button

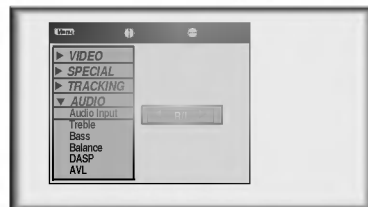

- 3** Press the (**▲**, **▼**) buttons to select a audio item you want to adjust.

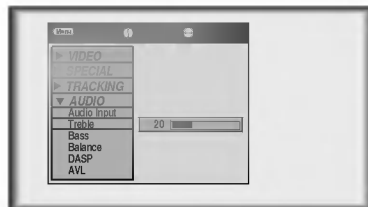

- 4** Move the **POINTER** button left or right or press the **VOLUME** (+, -) button to adjust the selected audio condition as you want.

- To finish menu display, press the **MENU** button repeatedly.



\* It's impossible to use Audio input R/L and MIC simultaneously. This is the menu which select one of R/L(Audio input of external equipment) and MIC(Microphone).

**1** Press the **MIC** button.



**2** Each press of the **MIC** button changes the screen as shown below.

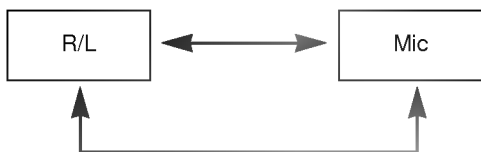

\* You can also use this function by using the **MENU** button.

\* This function lets you enjoy the best sound without any manual adjustment because the monitor automatically selects the appropriate audio tone levels based on the program content.

**1** Press the **DASP** button.



**2** Each press of the **DASP** button changes the screen as shown below.

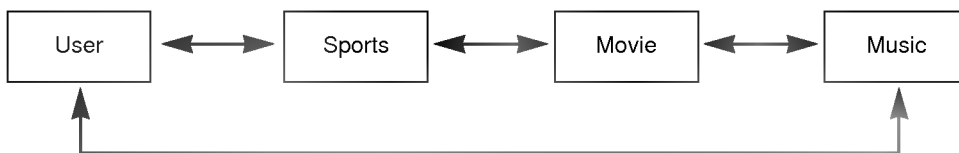

\* You can also use this function by using the **MENU** button.

\* This feature maintains an equal volume level even if you change channels.

**1** Press the **AVL** button.



**2** Each press of the **AVL** button changes the screen as shown below.

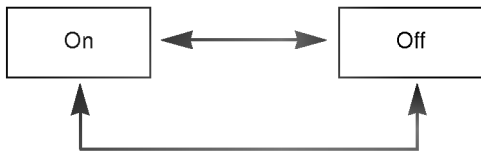

\* You can also use this function by using the **MENU** button.

- \* Connect the RS-232C input jack to an external control device (such as a computer or an A/V control system) and control the Monitor's functions externally.
- \* When you connect a control(RS-232C) cable to this monitor, use a control cable with a ferrite core attached. If you do not do this, this monitor will not conform to mandatory CISPR22(EN55022) standards.

## SET ID

- Use this function to specify monitor ID number.

**1** Press the **MENU** button and move the **POINTER** button up or down to select the **SPECIAL** menu.

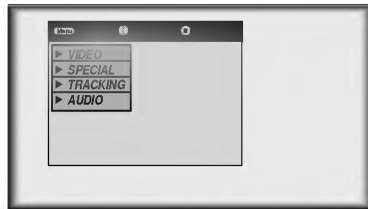

**2** Press the **ENTER**(■) button and move the **POINTER** button up or down to select the [Set ID].

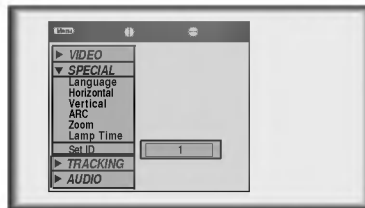

**3** Move the **POINTER** button left or right to adjust Set ID to choose the desired monitor ID number.

- The adjustment range of **Set ID** is 1~99.
- If monitor have specified ID number, the choosed monitor operates only.
- To exit the menu display, press the **MENU** button.

## How to connect external control equipment

- Connect the serial port of the PC to the RS-232C jack on the monitor back panel.
- RS-232C cable is not supplied with the Monitor.

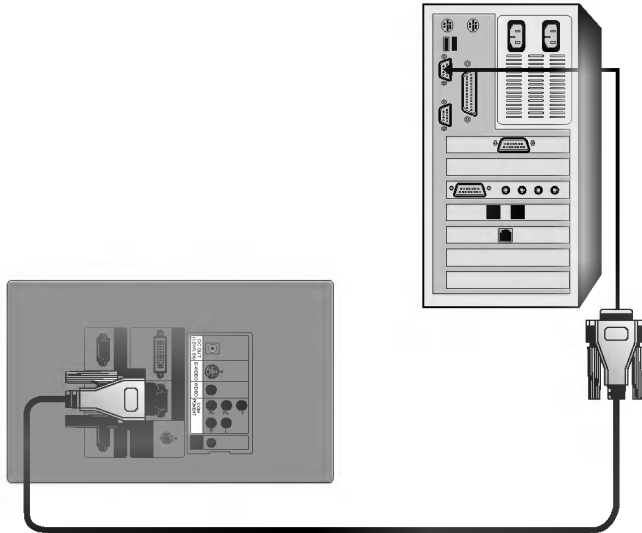

- Use the RS232C cable to control the monitor externally (Refer to Fig.1).

<Fig.1, RS-232 Interface Cable>

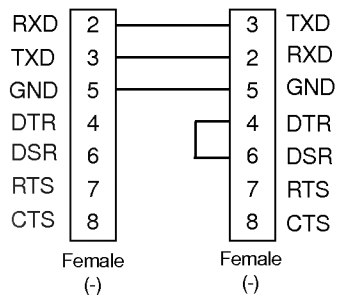

\* 1, 9 Pin No Connection

### Communication Parameter Setup

- Baud Rate : 19200 bps(UART)
- Data Length : 8 bits
- Parity : none
- Stop bit : 1 bit
- Flow Control : none
- Function, Arrows, and keys act as : Terminal keys
- Back space key sends : Ctrl + H
- Emulation : ANSIW
- Telnet Terminal ID : VT100
- Back Scroll buffer lines : 500
- ASCII Sending
  - Send Line ends with line feeds
  - Echo typed characters locally
    - Line delay : 0 ms
    - Character delay : 0 ms
- ASCII Receiving
  - Append Line feeds to incoming line ends
  - Force incoming data to 7-bit ASCII
  - Wrap lines that exceed terminal width

## External control device setup

### Command Reference List

	Command1	Command2-1	Command2-2	SET ID Data(Hexa)	Data(Hexa)
01. Power	k	0	0	00 ~ 63	00, 01
02. Input Select	k	0	1	00 ~ 63	00~05
03. Aspect Ratio	k	0	2	00 ~ 63	00~02
04. Screen Mute	k	0	3	00 ~ 63	00, 01
05. Volume Mute	k	5	4	00 ~ 63	00, 01
06. Volume Control	k	5	0	00 ~ 63	00~64
07. Contrast	k	3	0	00 ~ 63	00~64
08. Brightness	k	3	1	00 ~ 63	00~64
09. Color	k	3	2	00 ~ 63	00~64
10. Tint	k	3	3	00 ~ 63	00~64
11. Sharpness	k	3	4	00 ~ 63	00~64
12. OSD select	k	9	0	00 ~ 63	00, 01
13. Remote Control lock	k	9	1	00 ~ 63	00, 01
14. Treble	k	5	1	00 ~ 63	00~64
15. Bass	k	5	2	00 ~ 63	00~64
16. Balance	k	5	3	00 ~ 63	00~64
17. Color R	k	3	6	00 ~ 63	00~64
18. Color G	k	3	7	00 ~ 63	00~64
19. Color B	k	3	8	00 ~ 63	00~64

### □ Communication Protocol

#### 1. Transmission

[Command1][Command2-1][Command2-2][Set ID][Data][Cr]

- \* [Command 1] : To classify factory adjustment mode or user adjustment mode.(ASCII code, 1 Character)
- \* [Command 2-1] : Group classification code to control set.(ASCII code, 1 Character)  
→ Shortening Key Group :0, Video Group : 3. Audio Group:5, PIP Group :7, Others : 9
- \* [Command 2-2] : To control monitor set.
- \* [Set ID] : You can adjust the set ID to choose desired monitor ID number in special menu. See previous page.  
Adjustment range is 1 ~ 99. When selecting Set ID '0', every connected monitor set is controlled.
- \* [DATA] : To transmit command data. Transmit 2 character when organized ASCII code.  
\* Transmit 'FF' data to read status of command.
- \* [Cr] : Carriage Return  
ASCII code '0x0D'  
ENTER Key
- \* [ ] : ASCII code character correspond to "Space Bar" which is in order to classify command set ID and Data.

[Command2-1][Command2-2][Set ID][OK][Data][X]

- \* The Monitor transmits ACK (acknowledgement) based on this format when receiving normal data. At this time, if the data is data read mode, it indicates present status data. If the data is data write mode, it returns the data of the PC computer.

#### 2. Error Acknowledge

[Command2-1][Command2-2][Set ID][NG][Data][X]

- \* The Monitor transmits ACK (acknowledgement) based on this format when receiving abnormal data from non-viable functions or communication errors.

Data : [01] : illegal code(This command is not supported.)  
[02] : not support function(This function doesn't work.)  
[03] : wait more time(Try again a few minute later.)

## 01. Power (Command2-1:0, Command2-2:0)

→ To control Power On/Off of the Monitor.

### Transmission

[k] [0] [0] [Set ID] [ ] [Data] [Cr]

Data 00 : Power Off  
01 : Power On

### Ack

[0] [0] [ ] [Set ID] [ ] [OK] [Data] [X]

Data 00 : Power Off  
01 : Power On

→ To show Power On/Off.

### Transmission

[k] [0] [0] [ ] [Set ID] [ ] [FF] [Cr]

### Ack

[0] [0] [ ] [Set ID] [ ] [OK] [Data] [X]

Data 00 : Power Off  
01 : Power On

\* In like manner, if other functions transmit 'FF' data based on this format, Acknowledgement data feed back presents status about each function.

## 02. Input Select (Command2-1:0, Command2-2:1)

→ To select input source for the Monitor.

### Transmission

[k] [0] [1] [ ] [Set ID] [ ] [Data] [Cr]

Data 00 : RGB1 01 : RGB2 02 : RGB3  
03 : Video 04 : S-Video 05 : Component

### Ack

[0] [1] [ ] [Set ID] [ ] [OK] [Data] [X]

Data 00 : RGB1 01 : RGB2 02 : RGB3  
03 : Video 04 : S-Video 05 : Component

## 03. Aspect Ratio (Command2-1:0, Command2-2:2)

→ To adjust the screen format.

### Transmission

[k] [0] [2] [ ] [Set ID] [ ] [Data] [Cr]

Data 00 : Wide screen (16:9)  
01 : Normal screen (4:3)  
02 : Full screen (Zoom 1)  
03 : Zoom 2  
04 : Zoom 3

### Ack

[0] [2] [ ] [Set ID] [ ] [OK] [Data] [X]

Data 00 : Wide screen (16:9)  
01 : Normal screen (4:3)  
02 : Full screen (Zoom 1)  
03 : Zoom 2  
04 : Zoom 3

\* Using the PC input, you select either 16:9 or 4:3 screen aspect ratio.

## 04. Screen Mute (Command2-1:0, Command2-2:3)

→ To select screen mute on/off.

### Transmission

[k] [0] [3] [ ] [Set ID] [ ] [Data] [Cr]

Data 01 : Screen Mute On (Picture Off)  
00 : Screen Mute Off (Picture On)

### Ack

[0] [3] [ ] [Set ID] [ ] [OK] [Data] [X]

Data 01 : Screen Mute On (Picture Off)  
00 : Screen Mute Off (Picture On)

## 05. Volume Mute (Command2-1:5, Command2-2:4)

→ To control volume mute on/off.

### Transmission

[k] [5] [4] [ ] [Set ID] [ ] [Data] [Cr]

Data 00 : Volume Mute On (Volume Off)  
01 : Volume Mute Off (Volume On)

### Ack

[5] [4] [ ] [Set ID] [ ] [OK] [Data] [X]

Data 00 : Volume Mute On (Volume Off)  
01 : Volume Mute Off (Volume On)

## External control device setup

### 06. Volume Control (Command2-1:5, Command2-2:0)

→ To adjust volume.

#### Transmission

[k] [5] [0] [ ] [Set ID] [ ] [Data] [Cr]

Data Min : 00 ~ Max : 64  
\* Refer to 'Real data mapping 1'.

#### Ack

[5] [0] [ ] [Set ID] [ ] [OK] [Data] [X]

Data Min : 00 ~ Max : 64

### 07. Contrast (Command2-1:3, Command2-2:0)

→ To adjust screen contrast.

#### Transmission

[k] [3] [0] [ ] [Set ID] [ ] [Data] [Cr]

Data Min : 00 ~ Max : 64  
\* Refer to 'Real data mapping 1'.

#### Ack

[3] [0] [ ] [Set ID] [ ] [OK] [Data] [X]

Data Min : 00 ~ Max : 64

### 08. Brightness (Command2-1:3, Command2-2:1)

→ To adjust screen brightness.

#### Transmission

[k] [3] [1] [ ] [Set ID] [ ] [Data] [Cr]

Data Min : 00 ~ Max : 64  
\* Refer to 'Real data mapping 1'.

#### Ack

[3] [1] [ ] [Set ID] [ ] [OK] [Data] [X]

Data Min : 00 ~ Max : 64

### 09. Color (Command2-1:3, Command2-2:2)

→ To adjust the screen color.

#### Transmission

[k] [3] [2] [ ] [Set ID] [ ] [Data] [Cr]

Data Min : 00 ~ Max : 64  
\* Refer to 'Real data mapping 1'.

#### Ack

[3] [2] [ ] [Set ID] [ ] [OK] [Data] [X]

Data Min : 00 ~ Max : 64

### 10. Tint (Command2-1:3, Command2-2:3)

→ To adjust the screen tint.

#### Transmission

[k] [3] [3] [ ] [Set ID] [ ] [Data] [Cr]

Data Min : 00 ~ Max : 64  
\* Refer to 'Real data mapping2'.

#### Ack

[3] [3] [ ] [Set ID] [ ] [OK] [Data] [X]

Data Min : 0 ~ Max : 64

* Real data mapping 1	* Real data mapping 2
0 : Step 0	0 : Step -50
⋮	⋮
A : Step 10	32 : Step 0
⋮	⋮
F : Step 15	64 : Step 50
10 : Step 16	
⋮	
64 : Step 100	

\* This is a Hexadecimal number data.

### 11. Sharpness (Command2-1:3, Command2-2:4)

→ To adjust the screen sharpness.

#### Transmission

[k] [3] [4] [ ] [Set ID] [ ] [Data] [Cr]

Data Min : 00 ~ Max : 64  
\* Refer to 'Real data mapping 1'.

#### Ack

[3] [4] [ ] [Set ID] [ ] [OK] [Data] [X]

Data Min : 00 ~ Max : 64

### 12. OSD Select (Command2-1:9, Command2-2:0)

→ To select OSD (On Screen Display) On/Off.

#### Transmission

[k] [9] [0] [ ] [Set ID] [ ] [Data] [Cr]

Data 00 : OSD Off  
01 : OSD On

#### Ack

[9] [0] [ ] [Set ID] [ ] [OK] [Data] [X]

Data 00 : OSD Off  
01 : OSD On



### 13. Remote Control lock (Command2-1:9, Command2-2:1)

→ To lock the front panel controls on the monitor and remote control.

#### Transmission

[k] [9] [0] [ ] [Set ID] [ ] [Data] [Cr]

Data 00 : Lock Off  
01 : Lock On

#### Ack

[9] [0] [ ] [Set ID] [ ] [OK] [Data] [X]

Data 00 : Lock Off  
01 : Lock On

\* If you're not use the remote control, set this mode.

### 14. Treble (Command2-1:5, Command2-2:1)

→ To adjust treble.

#### Transmission

[k] [5] [1] [ ] [Set ID] [ ] [Data] [Cr]

Data Min : 00 ~ Max : 64  
\* Refer to 'Real data mapping 1'.

#### Ack

[5] [1] [ ] [Set ID] [ ] [OK] [Data] [X]

Data Min : 00 ~ Max : 64

### 15. Bass (Command2-1:5, Command2-2:2)

→ To adjust bass.

#### Transmission

[k] [5] [2] [ ] [Set ID] [ ] [Data] [Cr]

Data Min : 00 ~ Max : 64  
\* Refer to 'Real data mapping 1'.

#### Ack

[5] [2] [ ] [Set ID] [ ] [OK] [Data] [X]

Data Min : 00 ~ Max : 64

### 16. Balance (Command2-1:5, Command2-2:3)

→ To adjust balance.

#### Transmission

[k] [5] [3] [ ] [Set ID] [ ] [Data] [Cr]

Data Min : 00 ~ Max : 64  
\* Refer to 'Real data mapping 2'.

#### Ack

[5] [3] [ ] [Set ID] [ ] [OK] [Data] [X]

Data Min : 00 ~ Max : 64

### 17. Color R Adjustment (Command2-1:3, Command2-2:6)

→ To adjust red in color temperature.

#### Transmission

[k] [3] [6] [ ] [Set ID] [ ] [Data] [Cr]

Data Min : 00 ~ Max : 64  
\* Refer to 'Real data mapping 1'.

#### Ack

[3] [6] [ ] [Set ID] [ ] [OK] [Data] [X]

Data Min : 00 ~ Max : 64

### 18. Color G Adjustment (Command2-1:3, Command2-2:7)

→ To adjust green in color temperature.

#### Transmission

[k] [3] [7] [ ] [Set ID] [ ] [Data] [Cr]

Data Min : 00 ~ Max : 64  
\* Refer to 'Real data mapping 1'.

#### Ack

[3] [7] [ ] [Set ID] [ ] [OK] [Data] [X]

Data Min : 00 ~ Max : 64

### 19. Color B Adjustment (Command2-1:3, Command2-2:8)

→ To adjust blue in color temperature.

#### Transmission

[k] [3] [8] [ ] [Set ID] [ ] [Data] [Cr]

Data Min : 00 ~ Max : 64  
\* Refer to 'Real data mapping 1'.

#### Ack

[3] [8] [ ] [Set ID] [ ] [OK] [Data] [X]

Data Min : 00 ~ Max : 64

RS-232C

\* The monitor displays images at a resolution of 1280x720 pixels.  
 To display higher resolution images(1152x864mode, 1280x1024mode), the monitor compresses it to 1280x720.  
 The following table lists the display formats supported by the monitor.

Proposed	Format	Vertical Freq.(Hz)	Horizontal Freq.(kHz)	Video system	Remarks
SDTV, DVD 480i	640X480	60Hz	15.73kHz	NTSC M	3.579545MHz/60Hz
SDTV, DVD 480i	640X480	59.94Hz	15.63kHz	NTSC	4.433618MHz/60Hz
EDTV 480p	704X480	59.94Hz	31.47kHz	PAL B, G, H, I	4.433618MHz/50Hz
SDTV, DVD 625 Line	720X576	50.00Hz	15.625Hz	PAL M	3.575611MHz/60Hz
HDTV 576p	720X576	50.00Hz	31.25Hz	PAL N	3.582056MHz/50Hz
HDTV 720p 60Hz	1280X720	60.00Hz	45.00Hz	SECAM	4.286MHz/50Hz
HDTV 720p 59.94Hz	1280X720	59.94Hz	44.96Hz	PAL 60	4.433618MHz/60Hz
HDTV 1080i 50Hz	1920X1080	50.00Hz	31.25Hz		
HDTV 1080i 60Hz(ATSC)	1920X1080	60.00Hz	33.75Hz		
HDTV 1080i 59.94Hz	1920X1080	59.94Hz	33.72Hz		

Sources	Format	Vertical Freq. (Hz)	Horizontal Freq. (kHz)
VGAEGA	640X350	70.090Hz	31.468kHz
	640X350	85.080Hz	37.861kHz
PC98 / VGA text	640X400	85.080Hz	37.861kHz
	720X400	70.082Hz	31.469kHz
	720X400	85.039Hz	37.927kHz
VGA	640X480	59.940Hz	31.469kHz
	640X480	72.800Hz	37.861kHz
	640X480	75.00Hz	37.500kHz
	640X480	85.008Hz	43.269kHz
	640X480	100.040Hz	53.011kHz
SVGA	800X600	56.250Hz	35.156kHz
	800X600	60.317Hz	37.879kHz
	800X600	72.188Hz	48.077kHz
	800X600	75.00Hz	46.875kHz
	800X600	85.061Hz	53.674kHz
	800X600	100.00Hz	64.016kHz
XGA	1024X768	43.479Hz (interlace)	35.522kHz
	1024X768	60.004Hz	48.363kHz
	1024X768	70.069Hz	56.476kHz
	1024X768	75.029Hz	60.023kHz
	1024X768	84.997Hz	68.677kHz
SXGA	1152X864	60.053Hz	54.348kHz
	1152X864	70.016Hz	63.995kHz
	1152X864	75.00Hz	67.500kHz
	1152X864	85.057Hz	77.487kHz
	1280X960	60.00Hz	60.00kHz
	1280X960	75.00Hz	75.00kHz
	1280X1024	60.020Hz	63.981kHz
MAC	16" 832X624	74.550Hz	49.725kHz
	19" 1024X768	60.004Hz	48.363kHz
	1024X768	75.029Hz	60.241kHz
	20" 1152X870	75.062Hz	68.681kHz
HD	1920X1080i	50.00Hz	28.125kHz
	1920X1152i	50.00Hz	31.250kHz
	1920X1080i	60.00Hz	33.750kHz
	1280X720p	60.00Hz	45.00kHz

\* If the monitor does not support the input signal, "Out of Range" message appears on the screen.

\* The monitor supports DDC1/2B type as Plug & Play function.(Auto recognition of PC monitor)

\* Synchronization input form : Separate, Composite

# Specifications

Width(mm)	1440
Heigh(mm)	1080
Depth(mm)	491.5
Weight(kg)	66.75
LCD panel size	30.734mm(1.21 inches)
Resolution	1280(Horizontal) x 720(Vertical)pixel

## Operating Condition

In operation : 32~104°F(0°C~40°C)  
In storage and transit : -4~140°F(-20°C~60°C)

## Lamp

In operation : 30 ~ 80% relative humidity by dry hygrometer  
Not in operation : 30 ~ 90% relative humidity by dry hygrometer



P/NO : 3828VA0349A(373-026H)

