



WAP Phone

USER'S MANUAL

MODEL : W5200

Please read this manual carefully
before operating your set.
Retain it for future reference.

W5200 has a polished style which provides users' a better feel and convenience.



For Your Safety

All radio transmitters carry risks of interference with electronics in close proximity.



GSM Phones must be switched off at all times in an aircraft.



Do not activate near petrol stations, fuel depots, chemical plants or blasting operations.



Switch off the phone in any area where are forced by special regulations. For example, the phone does not allow to be used in hospital because pacemakers and hearing aids can be affected.



Minor interference may affect TVs, radios, PCS, etc.



Do not hold the phone in your hand while driving.



Do not dismantle phone or battery.



Keep the phone in a safe place out of children's reach since it contains the detachable small parts and create a choking hazard.



Do not touch the charger with wet hands.

Please note:



Use only specified batteries and chargers as others can damage the phone.



Unusable batteries should be disposed of in accordance with relevant legislation.



Only use ORIGINAL accessories to avoid damage to your phone.



Emergency call may not be available under all cellular networks. Therefore, you should never depend solely on the phone for essential communications such as medical emergencies.

Important Information

This user's guide contains important information on the use and operation of this phone. Please read all the information carefully for optimal performance and to prevent any damage to or misuse of the phone. Any changes or modifications not expressly approved in this user's guide could void your warranty for this equipment.

Contents

Overview

Accessories	9
--------------------------	---

Part of the Phone	10
--------------------------------	----

- Front of the Phone 10
- Rear of the Phone 10
- Sub LCD of the phone 12

Key Description	13
------------------------------	----

- Side of the Key 14
- Alphanumeric Keys 14

Display Information

Display Information	15
----------------------------------	----

- On-Screen Icons 15

Getting Started

Installation	17
---------------------------	----

- Inserting the SIM Card 17
- Installing the Battery 17
- Charging the Battery 18
- Disconnecting the charger 18

Powering On Sequence	20
-----------------------------------	----

- To get started with the phone 20
- To turn off the phone 20

Making and Answering calls	21
---	----

- Making a call 21
- International Calls 21
- Making a call using the Phonebook 21
- Making call by Speed dials. 21

Access Codes	22
---------------------------	----

- PIN code (4 to 8 digits) 22
- PIN2 code (4 to 8 digits) 22
- PUK code (4 to 8 digits) 22
- PUK2 code (4 to 8 digits) 22
- Security code (4 to 8 digits) 22

Accessing the Menu

Phonebook	23
------------------------	----

- Search [Names 1] 23
- Add new [Names 2] 24
- Caller groups [Names 3] 26

• Speed dial [Names 4]	27
• Settings [Names 5]	27
• Delete all [Names 6]	28
• Copy all [Names 7]	28
• Voice list [Names 8]	29
• Information [Names 9]	29
Menu Tree	30
Messages [Menu 1]	32
• Write message [Menu 1-1]	32
• Inbox [Menu 1-2]	35
• Outbox [Menu 1-3]	36
• Info service [Menu 1-4]	36
• Namecard [Menu 1-5]	38
• Templates [Menu 1-6]	38
• Delivery report [Menu 1-7]	38
• Settings [Menu 1-8]	39
• Check memory [Menu 1-9]	40
Call register [Menu 2]	41
• Missed calls [Menu 2-1]	41
• Received calls [Menu 2-2]	41
• Dialed calls [Menu 2-3]	41
• All calls list [Menu 2-4]	41
• Clear recent calls [Menu 2-5]	41
• Call charge [Menu 2-6]	42
Profiles [Menu 3]	44
• Vibrate only [Menu 3-1]	44
• Silent [Menu 3-2]	44
• General [Menu 3-3]	44
• Loud [Menu 3-4]	44
• Headset [Menu 3-5]	44
• Handsfree [Menu 3-6]	45
Settings [Menu 4]	46
• Alarm clock [Menu 4-1]	46
• Clock [Menu 4-2]	47
• Phone settings [Menu 4-3]	48
• Call settings [Menu 4-4]	49
• Security settings [Menu 4-5]	52
• Network settings [Menu 4-6]	55
• Restore factory settings [Menu 4-7]	55

Call divert [Menu 5]	56
• All voice calls [Menu 5-1]	56
• If busy [Menu 5-2]	56
• If not answered [Menu 5-3]	56
• If out of reach [Menu 5-4]	56
• All data calls [Menu 5-5]	56
• All fax calls [Menu 5-6]	56
• Cancel all divers [Menu 5-7]	57
Scheduler [Menu 6]	58
• New [Menu 6-1]	59
• View day [Menu 6-2]	60
• View all [Menu 6-3]	60
• Delete last [Menu 6-4]	60
• Delete all [Menu 6-5]	60
Fun & Tools [Menu 7]	61
• My folder [Menu 7-1]	61
• Game [Menu 7-2]	62
• Ring composer [Menu 7-3]	62
• Graphic editor [Menu 7-4]	62
• Unit converter [Menu 7-5]	63
• Calculator [Menu 7-6]	63
• World time [Menu 7-7]	64
Internet [Menu 8]	65
• Home [Menu 8-1]	65
• Bookmarks [Menu 8-2]	65
• Push messages [menu 8-3]	65
• Profiles [Menu 8-4]	66
• Go to URL [Menu 8-5]	67
• Cache settings [Menu 8-6]	68
• Security certif. [Menu 8-7]	68
• Reset profiles [Menu 8-8]	68
On line menu	69
SIM service [Menu 9]	70
Additional Functions	
How to Use Data and Fax call	71
• Sending Data or Fax Calls	71
• Receiving Data or Fax Calls	71
In call Menu	73
• 1 DURING A CALL	73
• 2 Multiparty or Conference Calls	75
Care and Maintenance	77

Check to make sure that you have all the parts shown below.

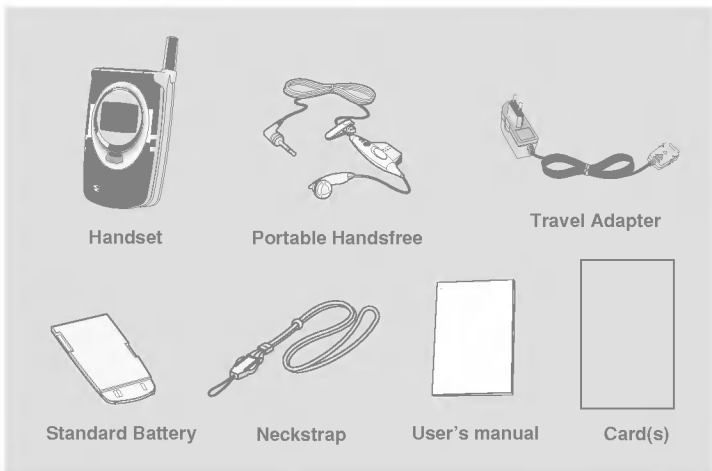

<Optional Accessories>

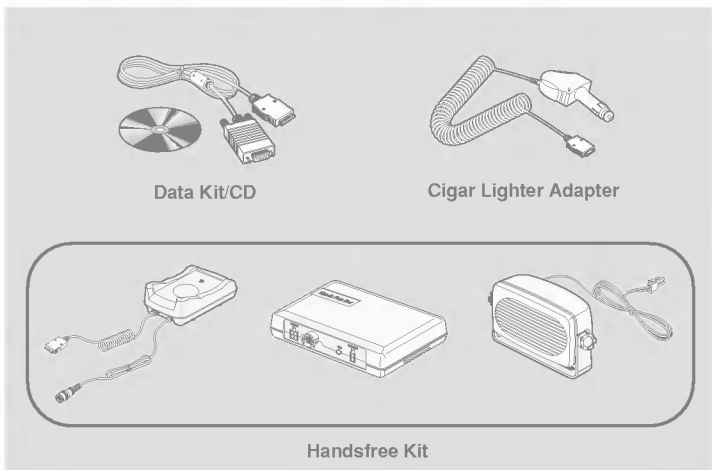

Front of the Phone

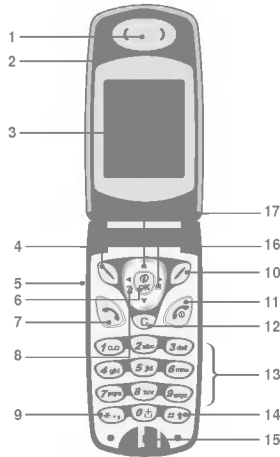

- | | |
|--------------------|--------------------|
| 1 Earpiece | 9 Star Key |
| 2 Active Folder | 10 Soft Right Key |
| 3 Display Screen | 11 End/Power Key |
| 4 Soft Left Key | 12 Cancel Key |
| 5 Up/Down Side Key | 13 Numeric Keys |
| 6 Confirm Key | 14 Hash Key |
| 7 Send Key | 15 Microphone |
| 8 Vibration Key | 16 Message key |
| | 17 Navigation keys |

Rear of the Phone

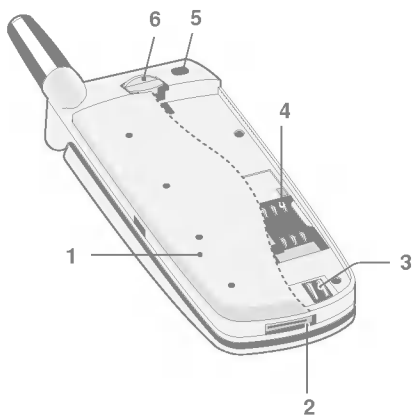

- 1 Battery
- 2 Cable Connector/
Battery Charging Connector/
Hands-Free Car kit Connector
- 3 Battery Terminals
- 4 SIM Card Socket
- 5 Handstrap Hole
- 6 Battery Lock

Sub LCD of the phone

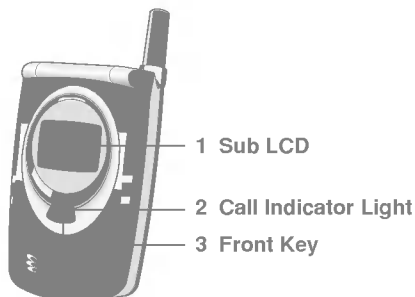











- 1 You can view the icon of receiving text message or voicemail even not opening folder. In addition, you can check the name and number for incoming and outgoing calls.
- 2 You can check the network status through this indicator. Depending on Group setting, you can also change its color.
- 3 If you press this key for a long time in a standby mode with closing a folder, you can convert the vibration mode. Furthermore, you can reject a call when it is incoming.

● **Note!**

- If the name or number of entry is not saved in phonebook, "New call" will be displayed when making or receiving a call.

The following shows key components of the phone.

Keypad Description

Key	
	<p>Soft Left Key / Soft Right Key Each of these keys performs the function indicated by the text on the display immediately above it.</p>
	<p>Vibration key You can activate the vibration directly.</p> <p>Message key You can go to Message menu directly without scrolling.</p> <p>Navigation Keys Used to scroll through name, phone numbers, menus or setting options.</p> <p>WAP hot key If you press this key for a while, you can connect to WAP directly.</p>
	<p>Send Key You can dial a phone number and answer a call. If you press this key without entering a number, your phone shows the most recently dialed, received and missed numbers.</p>
	<p>Numeric Keys These keys are used mainly to dial in standby mode and enter numbers or characters in editing mode. When you press these keys for a long time.</p> <ul style="list-style-type: none"> Used to call your voicemail box by . Used to call for international call by . Used to call Speed dials by from  to .
	<p>END/PWR Key Used to end or reject a call. This key is also used as Power Key by pressing this key for a few seconds.</p>
	<p>You can delete the characters, go back the menu or deactivate the function. If you press  in a standby mode, you can use Voice memo function.</p>

Side of the Key

i	Key
	<p>Up/Down Side Key You can control the volume of key tone in standby mode and also control the volume during a call.</p>



















Alphanumeric Keys

The alphabet and numerical keypad mapping relation are listed as the following table.









Key	
	., ' ? ! - & 1
	A B C 2 Ä Å Æ Ç a b c à ä å ß B
	D E F 3 É ê e f è é
	G H I 4 g h i
	J K L 5 j k l
	M N O 6 Ñ Ò Ø m n o ñ ò ö ø
	P Q R S 7 p q r s
	T U V 8 Ů t u v ù ü
	W X Y Z 9 w x y z
	0 (Spec key)

The screen displays several icons the following describe each of them you may see on the phone.

On-Screen Icons

Icon/Indicator	
	Tells you the strength of the network signal.
	Call is connected.
	Shows that you are using a roaming service.
	Line 1/2 is in use for outgoing calls - If you subscribe to the Two Line Service.
	The alarm has been set and is on.
	Tells you the status of the battery.
	You have received a text message.
	You have received a voice message.
	You have received an E-mail.
	You can view your schedule.
	All audible signals are turned off.
	General menu in profile.
	Loud menu in profile.
	Silent menu in profile.
	Headset menu in profile.
	Car menu in profile.
	You can divert a call.
	Shows that you can use push message service.

Top Menu Icons

Icon	
	Messages
	Call register
	Profiles
	Settings
	Call divert
	Scheduler
	Fun & Tools
	Internet
	SIM Service (Dependent on SIM)

1 Inserting the SIM Card

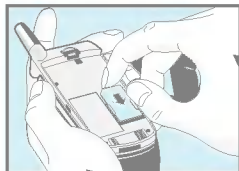

Locate the SIM card socket in the back of the phone.
Follow the steps below to install the SIM card.

1. Remove the battery if attached.
2. Slide the SIM card into the slot, under the silvery holders, with the golden connectors facing down and the cut corner to the right,

● Notice

- Before installing always make sure that the phone is switched off and remove the battery.
- The metal contact of the SIM card can be easily damaged by scratches. Pay special attention to the SIM card when you handle and install. Follow the instructions supplied with the SIM card.

2 Installing the Battery

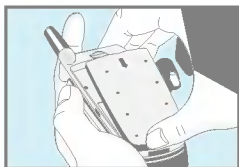

1. Place the battery on the back of the phone.

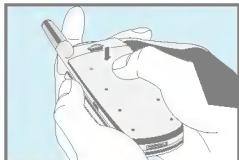

2. Push it until you hear a click.

3 Charging the Battery

To connect the travel adapter to the phone, you must have installed the battery.

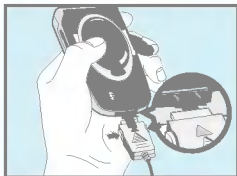

1. Insert one end of the travel adapter into the bottom of the phone.

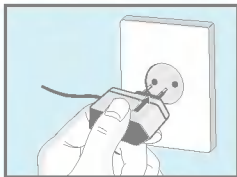

2. Connect the other end of the travel adapter to an AC wall outlet.
Use only the included packing charger.

● Warning

- Do not force the connector as this may damage the phone and/or the travel adapter.

4 Disconnecting the charger



Disconnect the travel adapter from the phone by pressing its side buttons.

● **Note**

- Remember to fully charge the used battery after changing the batteries.
- Do not remove your battery or the SIM card while charging.
- The moving bars of battery icon will stop after charging completely.

● **Note**

- In case of not charging the battery properly...
 1. After switching On/Off Power key, please try to recharge it.
 2. In case of the battery is attached, please detach it from the phone. And then place it back, please try to recharge it.

① To get started with the phone







1. Press and hold  key until you hear a tone.
2. Depending on setting **PIN code**, you can enter PIN code or not.
3. If your phone connects to a network, the network name will be displayed shortly.



② To turn off the phone

In standby mode, press and hold  key until you hear a tone.



Making a call

1. Key in phone number including the area code, To edit a number on the display, press  to move cursor to the left and press  to move cursor to the right.
2. Press  to call the number.
3. Press  to end the call.

International Calls

1. Press and hold the  key for the international prefix. "+" character may replace with the international access code.
2. Enter the country code, area code, and the phone number.
3. Press .

Making a call using the Phonebook

1. In a standby mode, press  [Names].
2. When the menu is displayed, you select **Search** by pressing  [OK].
3. If you find out the desired item through searching by a name or a number, press  to call.

Making a call by Speed dials.

See the menu **Phonebook - Speed dial** [Names 4] in detail.

You can use the access codes described in this section to avoid unauthorized use of your phone. The access codes (except PUK and PUK2 codes) can be changed by using [Menu 4-5-4].

PIN code (4 to 8 digits)

The PIN (Personal Identification Number) code protects your SIM card against unauthorized use. The PIN code is usually supplied with the SIM card. When **PIN code** is set **Enable**, your phone will request the PIN code every time it is switched on. On the contrary, when **PIN code** is set **Disable**, your phone connects to the network directly without the request PIN code.

PIN2 code (4 to 8 digits)

The PIN2 code, supplied with some SIM cards, is required to access some functions such as Advice of call charge, Fixed Dial number. These functions are only available if supported by your SIM card.

PUK code (4 to 8 digits)

The PUK(PIN Unblocking Key) code is required to change a blocked PIN code. The PUK code may be supplied with the SIM card. If not, contact your local service provider for the code. If you lose the code, also contact your service provider.

PUK2 code (4 to 8 digits)

The PUK2 code, supplied with some SIM cards, is required to change a blocked PIN2 code. If you lose the code, also contact your service provider.

Security code (4 to 8 digits)

The security code protects the unauthorized use of your phone. It is usually supplied with the phone. This code is required to delete all phone entries and to activate "Restore factory settings" menu. The default number is "1234".

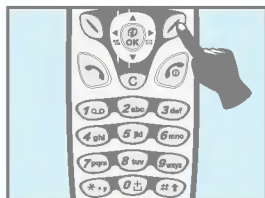

To select a menu in phonebook, press [Names] in standby mode and then scroll to a desired item.

1	Search	Allows you to search for a specific name.
2	Add new	Allows you to add new names and numbers.
3	Caller groups	Allows you to show group list.
4	Speed dial	Allows you to assign up to 8(-) one- touch dial allocations.
5	Settings	Allows you to set the memory and to search item by Variable, name and number.
6	Delete all	Allows you to erase all the data in either your phonebook or the SIM card to the phone memory.
7	Copy all	Allows you to copy entries from your Phone memory to SIM card or from SIM card to Phone memory.
8	Voice list	Allows you to list phone numbers which is attached voice.
9	Information	Allows you to check the status of memory, SDN(Service Dial Number), and Own number list.

Search [Names 1]

(Calling from phonebook)

1. Open the phonebook first by pressing [Names] in a standby mode.
2. **Search** by pressing [Select] to enter.
3. You can find an entry by name.
4. Select [Search].
5. If you want to edit, delete, copy an entry, or to add the voice to one, select [Options]. The below menu will be displayed.







- **Edit** : You can edit the name, number, E-mail, and fax by pressing  [OK].
- **Delete** : You can delete an entry.
- **Copy** : You can copy an entry from SIM to phone or from phone to SIM.
- **Call** : You can call thru the chosen entry.
- **Voice** : You can add the voice to the entry or change the voice tag.
- **Main number** : You can select the one out of mobile, home, office that you often use. The main number will be displayed first, if you set this.





Add new [Names 2]

You can add phonebook entry by using this function.

Phone memory capacity is 200 entries. SIM card memory capacity depends on the cellular service provider.

You can also save 20 characters of name in the Phone memory, and you can save characters in the SIM card. the number of character is SIM dependent feature.

1. Open the phonebook first by pressing  [Names] in standby mode.
2. Scroll to highlight **Add new**, and press  [Select] to enter.
3. Select the memory you want to save: **SIM** or **Phone**.
 - **SIM** : You can add name and number for entry.
 - a. Write a name to add.
 - b. Press  [OK], then you can input a number.
 - c. Press  [OK].
 - d. You can set a group for the entry by pressing  :
Family, Colleague, VIP, Others, Group 1, Group 2.
 - e. If you want to add the voice, press  [Yes].

- **Phone** : You can add name, number and E-mail address.
 - a. Write a name to add.
 - b. Press  [OK].
 - c. Enter the numbers following as mobile, home, office, and fax by pressing  [OK]. Also, you can input E-mail address.
 - d. You can set a group for the entry by pressing  : **Family, Colleague, VIP, Others, Group 1, Group 2.**
 - e. If you want to add the voice, press  [Yes].



You should speak a word within 2 seconds, and the phone asks you to speak it again to ensure the accuracy of voice recognition. After voice recognition has finished, Voice is attached automatically.

● Note



- The voice can only be attached to main number which you set. For example, If you change main number voice will be automatically attached changed number. This means that you cannot attach voice to mobile, office, home number simultaneously.
- You can add voice tag to phone number in SIM card. The voice tag can be erased if you remove or change SIM card.

Caller groups [Names 3]

You can list up to 20 members per one group. There are 7 groups you can make lists to.

1. Press  [Names] to enter into the phonebook in standby mode.
2. Scroll to **Caller groups** item then press  [Select] to enter this menu.
3. Every Group list will be displayed.: **Family, Friend, Colleague, VIP.**
4. Select Group name that you want to manage by pressing  [Select].
5. Then submenus below will be displayed.

• **Member list**

1. Scroll to highlight **Member list**, and then press  [Select] to enter.
2. The member lists are displayed.
3. Scroll to highlight required name. The number will be displayed in the below screen.
4. Press  [Options] to edit, to delete the name and phone number.

• **Group ring tone**

You can set the ring tone depending on Group.

• **Group icon**

You can set icon depending on Group.

• **Group call ani.**



You can set the animation for each group.

• **LED color**

You can set LED color depending on Group. You can also change it in 7 colors.

• **Add member**

You can add the member in Caller groups.

1. Scroll to highlight **Add member**, and then press  [Select] to enter.
2. The group member shouldn't be exceeded 20. Otherwise, the error message will be displayed.
3. Press  [OK] to add member.

- **Remove member**



You can delete the member already saved in phonebook.

- **Rename**

You can change group name.



Speed dial [Names 4]

You can assign any of the keys  to  with a Name list entry. You can call directly by pressing this key for 2-3 seconds.

1. Open the phonebook first by pressing  [Names] in a standby mode.
2. Scroll to **Speed dial**, then press  [Select] to enter this menu.
3. Every Speed dial will be displayed.
4. If you want to add Speed dial, select **<Empty>**. Then, you can search the name in phonebook.
5. If you select allocated name by speed dial, you can view following the submenus.
 - **Change** : You can change the allocation of Speed dial.
 - **Delete** : You can delete the allocated speed dial number.

Settings [Names 5]

You can set preferred memory which includes **Variable, SIM** or **Phone** and preferred search which includes **Variable, Name and Number**.





1. Open the phonebook first by pressing  [Names] in a standby mode.
2. Scroll to **Settings**, then Press  [Select] to enter.
3. Then submenus below will be displayed.
 - **Set memory**
 1. Scroll to highlight **Set memory**, then press  [Select] to enter.
 2. The three submenus are displayed.
 - If you select **Variable**, when adding entry, the phone will ask where to store.
 - If you select **SIM**, when adding entry, without asking where to store, the phone will store entry to SIM.
 - If you select **Phone**, when adding entry, without asking where to store, the phone will store entry to Phone memory.

• Search by

1. Scroll to highlight Search by, then press  [Select] to enter.
2. The three submenus are displayed.
 - If you select **Variable**, when searching, the phone will ask how to search.
 - If you select **Name**, when searching, without asking how to search, the phone will search entry by name.
 - If you select **Number**, when searching, without asking how to search, the phone will search entry by number.



Delete all [Names 6]

You can delete all entries in **SIM**, **Phone**, and **Voice**. This function requires Security code.





1. Press  [Names] to enter into the phonebook in standby mode.
2. Scroll to **Delete all**, then press  [Select].
3. Then select a memory to erase: **SIM**, **Phone**, **Voice**.
4. And then you will be requested to enter Security code.
5. Press  [OK] or, press  [Back] to cancel.

Copy all [Names 7]

You can copy/move entries from SIM card memory to Phone memory or from Phone memory to SIM card memory.

1. Open the phonebook first by pressing  [Names] in standby mode.
2. Scroll to **Copy all**, then press  [Select] to enter this menu.
3. Then submenus below will be displayed.
 - **SIM to Phone** : You can copy the entry from SIM Card to Phone memory.
 - **Phone to SIM** : You can copy the entry from Phone memory to SIM Card.

Voice list [Names 8]





You can see all phone numbers which contain voice. You can also call directly by pressing  [Send]. After selecting phone number by using  and  and press  [Options], you can see following the submenus.

- **Play** : You can play voice which is attached to phone number.
- **Change** : You can change voice which is attached to phone number.
- **Delete** : You can delete voice which is attached to phone number.
- **Call** : You can call by selecting this menu.

Information [Names 9]

Service Dial Number



Use this function to access a particular list of services provided by your network operator (if supported by the SIM card).

1. Open the phonebook first by pressing  [Names] in a standby mode.
2. Scroll to **Service Dial Number**, then press  [Select] to enter.
3. The names of the available services will be shown.
4. Use  and  to select a service. Press  [Send].

Check memory



This feature allows you to see how many free and in-use are in your phonebook.

1. Open the phonebook first by pressing  [Names] in standby mode. Select **Information** by pressing  [Select].
2. Scroll to **Check memory**, then press  [OK] to enter this menu.

Own number (SIM dependent)

You can check your own number in SIM card.



1 Messages

- 1 Write message
 - Send
 - Save
 - Use template
 - Use namecard
 - Add dictionary
 - List dictionary
- 2 Inbox
 - Delete
 - Edit
 - Forward
 - Get numbers
 - Reply
 - Return call
- 3 Outbox
 - Delete
 - Edit
 - Forward
 - Get numbers
- 4 Info service
 - 1 Read
 - 2 Receive CB
 - 3 Alert
 - 4 Language
 - 5 Topics
- 5 Namecard
- 6 Templates
- 7 Delivery report

8 Settings

- 1 Message type
- 2 Validity period
- 3 Status report
- 4 Pay for reply?
- 5 SMS centre
- 6 Voicemail centre
- 9 Check memory



2 Call register

- 1 Missed calls
- 2 Received calls
- 3 Dialed calls
- 4 All calls list
- 5 Clear recent calls
- 6 Call charge
 - 1 Call duration
 - 2 Call cost
 - 3 Setting



3 Profiles

- 1 Vibrate only
- 2 Silent
 - *-1 Enable
 - *-2 Change
- 3 General
- 4 Loud
- 5 Headset
- 6 Handsfree



4 Settings

- 1 Alarm clock
 - 1 Enable
 - 2 Disable
- 2 Clock
 - 1 Date
 - 2 Time
- 3 Phone settings
 - 1 Display
 - 2 Voice dial
 - 3 LED indicator
 - 4 Language
- 4 Call settings
 - 1 Minute minder
 - 2 Answer mode
 - 3 Send number
 - 4 Call waiting

- 5 Auto redial
- 6 Select line
- 7 Next incoming
- 8 CUG
- 5 Security settings
 - 1 PIN code
 - 2 Call barring
 - 3 FDN setting
 - 4 Change code
- 6 Network settings
 - 1 Automatic
 - 2 Manual
- 7 Restore factory settings



5 Call divert

- 1 All voice calls
- 2 If busy
- 3 If not answered
- 4 If out of reach
- 5 All data calls
- 6 All fax calls
- 7 Cancel all diverts



6 Scheduler

- 1 New
 - 1 Schedule
 - 2 Memo
- 2 View day
 - 1 Options
- 3 View all
- 4 Delete last
- 5 Delete all



7 Fun & Tools

- 1 My folder
 - 1 Picture
 - 2 Icon
 - 3 Animation
 - 4 Ring tone
 - 5 Sound
- 2 Game
- 3 Ring composer
- 4 Graphic editor
- 5 Unit converter
- 6 Calculator
- 7 World time



8 Internet

- 1 Home
- 2 Bookmarks
- 3 Push messages
 - 1 Inbox
 - 2 Receive
- 4 Profiles
- 5 Go to URL
- 6 Cache settings
 - 1 Clear cache
 - 2 Cache check
- 7 Security certif.
- 8 Reset profiles



9 SIM Service

This menu depends on SIM and the network services.

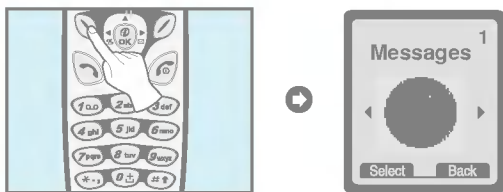

This menu includes functions related to SMS (Short Message Service), voice mail, as well as the network's service messages.

Write message [Menu 1-1]

You can write and edit text message up to 918 characters. Also, you can check the number of characters.

1. Enter the **Messages** menu by pressing [Select].
2. If you want to write a new message, select **Write message** in the menu.
3. Input the message by using eZi text. For details, see eZi text (Page 34).
4. When you finish writing your message, press [Options].
Then following option menu will be displayed.

Send

Sends the text message.

1. If you want to send the text message, enter the number you want.
2. Your phone asks you to enter the number that you want to send it to.
3. After sending it, your phone asks whether you will store the edited message.
4. Press if you want to store it in Outbox and press if you don't want to.

Save

Stores the message in Outbox.

1. Your phone asks whether you will save the edited message.
2. Press if you want to save it in Outbox and press if you don't want to.

Use template



The template is pre-defined message. You can add the template of the list to the message when you edit it.

Use namecard

The items of the name card are a name, mobile, office, fax, and email. You can add a namecard to the message.



Add dictionary

If you add a word you use often, you can input it by pressing a key once for each character.

1. Enter the menu.
2. Scroll to highlight **Add dictionary**, and then press  [Select].
3. Input a word, and then press  [Add].

List dictionary

You can view the list you already saved words in a dictionary.

1. Enter the menu.
2. Scroll to highlight List dictionary, and then press  [Select].
3. You can check the word list.
4. If you want to delete a word, press  [Delete].
5. If you want to delete all words in a list, select **Delete all** at the bottom of the list by pressing  [Select].

● EMS function

- If you press  in Write message menu, you can use EMS service.
 - **Attach symbol**
 - **Attach picture**
 - **Attach animation**
 - **Attach sound**

eZi-Text

The eZi text allows you to type easily and quickly. If you just press a key marked a character on the keypad, you can get a character you want. It is useful to make a word and a sentence. If you press **(#*)** key for a long time, you can change the type of language.

Also, the phone supports four modes: **eZi Mode**, **Numeric mode**, **Capital mode**, and **Small mode**. If you want to change mode, press **(#*)** key.

• How to Use in eZi mode

To input a character in eZi text mode, you just press each key once for a character you want.

For example, to write **Girl** in eZi mode;

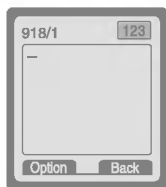
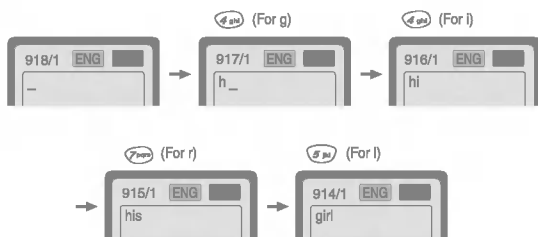

• How to use in Numeric mode

To input a number in Numeric mode, you press a number key displayed on the keypad.

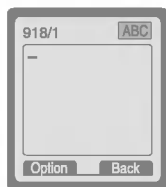

• How to use in Capital mode



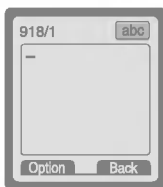

To input Capital letter, you press a character key displayed on the keypad.



• How to use in Small mode

To input Small letter, you press a character key displayed on the keypad.

Inbox [Menu 1-2]

When you receive a text message, your phone shows  and stores it in the incoming message lists. Scroll to the desired message by using , . In addition, you can see **Delete all** for deleting all incoming messages at the bottom of the list. During reading the message, press  [Options] to access the available options.

Delete

The selected message is deleted.

Edit

You can edit an incoming message and send or save the edited message.

Forward

You can forward the selected message to the other party.

Get numbers

If the selected message has the phone number, you can extract and save it in a phonebook. Also, you can call by this number.





Reply

You can reply to the sender by message.

Return call

You can call back to the sender who sent the message automatically.

Outbox [Menu 1-3]

When you enter this menu, you can see the outgoing call list. Scroll to the desired message by using  ,  and press  to see the message. And if you want to exit **Outbox** menu, press  .

In addition, you can see **Delete all** for deleting all outgoing messages at the bottom of the list.

While reading message, press  [Options] to access the following submenus.

Delete

The selected message is deleted.

Edit

You can edit an outgoing message and send or save it.

Forward

You can forward the selected message to the other party.

Get numbers



If the selected message has the phone number, you can extract and save it in a phonebook. Also, you can call by this number.

Info service [Menu 1-4]

(Dependent to network and subscription)

Cell Broadcast messages (CB Message) are text messages by the network to GSM phone users. They provide general information such as weather reports, traffic news, taxis, pharmacies, and stock prices. Each type of information has the number; therefore, you can contact service provider. When you receive CB message, you can read it following sequence:

Read [Menu 1-4-1]

1. When you receive CB message, it will be displayed on the screen. You can read the message by scrolling  , .
2. After reading the message, press  to return to the standby mode. In addition, you can save it until another message is reached.

Receive CB [Menu 1-4-2]

• Yes

If you select this menu, your phone will receive the Cell Broadcast message.

• No

If you select this menu, your phone will not receive the Cell Broadcast message any more.

Alert [Menu 1-4-3]

• Yes

If you select this menu, your phone will beep when Cell broadcast message is received.

• No

If you select this menu, your phone will not beep despite Cell broadcast message is received.

Language [Menu 1-4-4]

You can select the language you want. Then your phone will receive the cell broadcast message in your chosen language.

Topics (Dependent to network and subscription) [Menu 1-4-5]

- **Add**

If you select this menu, you will add the CB message category in Phone memory with its nickname.

- **View list**

If you select this menu, you can see CB message category which you added. If you press  [Option], you can edit and delete CB message category which you added.

- **Active list**

You can select the CB message category in active list by pressing  [Select].

Namecard [Menu 1-5]

It's for editing the namecard. The items of the namecard are a name, mobile, office, fax, and email.

- **Edit** : You can edit a namecard.
- **Delete** : You can delete a namecard.

Templates [Menu 1-6]

It's for editing pre-defined messages. You can see 11 pre-defined messages in the list. You can save 6 templates before you edit. But you can changed them. The others are **<Empty>**.

- **Edit** : You can edit a template.
- **Reset** : You can delete the template.

Delivery report [Menu 1-7]

You can read and delete delivery report messages.

Settings [Menu 1-8]

Message type [Menu 1-8-1]

Text, Voice, Fax, Natl. paging, X.400, E-mail, ERMES

Usually, the type of message is set to **Text**. You can convert your text into alternative formats, which are suitable for the device that will be received the message. Contact your service provider for the availability of this function.

Validity period [Menu 1-8-2]

This network service allows you to set how long your text messages will be stored at the message center while attempts are made to deliver them to you.

Status report [Menu 1-8-3]

If you set **Yes** in this menu, you can check whether your message is sent successfully or not.

Pay for reply? [Menu 1-8-4]

When a message is sent, it allows the person to whom you sent the message to reply and charges the cost of the reply to your telephone bill.

SMS centre [Menu 1-8-5]

If you want to send the text message, you can get the address of SMS centre through this menu.

Voicemail centre [menu 1-8-6]

You can get the voicemail if this feature is supported by the network service provider. When new voicemail is arrived, the symbol will be displayed on the screen. Please check with your network service provider for details of their service in order to configure the handset.

1. Press  key for a long time in standby mode.
2. You can check the following submenus.

- **Home [Menu 1-8-6-1]**

The number dialed on the home network to listen to voicemail.

- **Roam [Menu 1-8-6-2]**

The number dialed when other networks to listen to voicemail.

Check memory [Menu 1-9]

If you select this menu, the phone shows an used memory and total amount of memory. The total memory is the sum of SIM and Phone memory.

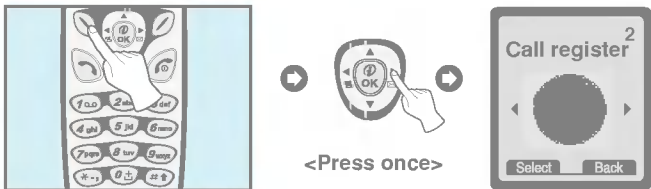

Missed calls [Menu 2-1]

This menu shows recently missed numbers. You can call by this number, also save and view date and time this menu.

Received calls [Menu 2-2]

This menu shows recently received numbers. You can call by this number, also save and view date and time.

Dialled calls [Menu 2-3]

This menu shows recently dialed numbers. You can call by this number, also save and view date and time.

All calls list [Menu 2-4]

You can save the phone number and check the date, time for a call. Moreover, you can call back to the other party.

Clear recent calls [Menu 2-5]





You can delete the all call records.

Call charge [Menu 2-6]

Within these submenus, you can view the duration and the call cost of your calls.

Call duration [Menu 2-6-1]





This function allows you to view the duration of your Last Call, All Calls, Incoming Calls and Outgoing Calls in hours, minutes and seconds. You can also reset the call timers.

1. Press  [Menu] in standby mode.
2. Press  for direct access or use  and  to enter **Call register**.
3. Scroll to highlight **Call duration** and Press  [Select].

The following 5 submenus: **Last call**, **All calls**, **Received calls**, **Dialled calls** and **Reset all**.

Call cost [Menu 2-6-2]

This function allows you to check the cost of your last call, all calls, remaining and reset the costs. To reset the cost, you need the PIN2 code.

1. Press  [Menu] in standby mode.
2. Press  for direct access or use  and  to enter **Call register**.
3. Scroll to highlight **Call cost** and Press  [Select] to enter.

The following 4 submenus: **Last call**, **All calls**, **Remaining** and **Reset all**.





Note

- The actual cost invoiced for calls by your service provider may vary, depending upon network features, rounding-off for billing, and taxes.

Setting [Menu 2-6-3] [SIM Dependent]

• Set tariff [Menu 2-6-3-1]

You can set the currency type and the unit price. Contact your services providers to obtain charging unit prices. To select the currency or unit in this menu, you need the PIN2 code.





1. Press  [Menu] in standby mode.
2. Press  for direct access or Use  and  to enter **Call register**.
3. Scroll to highlight **Setting** and Press  [Select] to enter.
4. Select **Set tariff**.

● Note

- When all units have been used, no calls can be made except emergency calls. Depending on the SIM card, you need the PIN2 code to set a call cost limit.





• Set credit [Menu 2-6-3-2]

This network service allows you to limit the costs of your calls by selected charging units. If you select **Read**, the number of remaining unit is shown. If you select **Change**, you can change your charge limit.

1. Press  [Menu] in a standby mode.
2. Press  for direct access or use  and  to enter **Call register**.
3. Scroll to highlight **Setting** and press  [Select] to enter.
4. Select **Set credit**.

• Auto display [Menu 2-6-3-3]

This network service allows you to see automatically cost of your last call. If you select **Yes** in **Auto display** menu, you can see the last cost when the call is released.

1. Press  [Menu] in standby mode.
2. Press  for direct access or use  and  to enter **Call register**.
3. Scroll to highlight **Setting** and press  [Select] to enter.
4. Select **Auto display**.

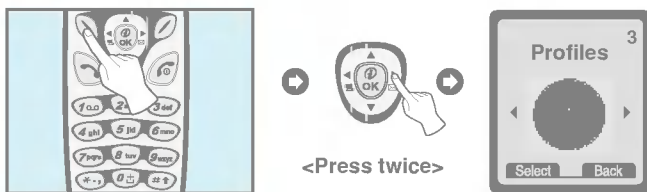

In this menu, you can adjust and customize the phone tones for different events, environments and caller's group.

1. Press **[Menu]** in standby mode.
2. Press **[3 out]** for direct access or use **[M]** and **[OK]** to enter **Profiles**.
3. You can also enter this menu directly by pressing **[M]** key in standby mode.

Vibrate only [Menu 3-1]

- **Enable** : You can adjust the profile as Vibration if you need vibration mode.

Silent [Menu 3-2]

- **Enable** : You can adjust the profile as Silent if you are in Quiet place.
- **Change** : You can change the values of Profile submenus.

General [Menu 3-3]

- **Enable** : You can adjust the profile as General.
- **Change** : You can change the values of Profile submenus.

Loud [Menu 3-4]

- **Enable** : You can adjust the profile as Loud if you are in a noisy environment.
- **Change** : You can change the values of Profile submenus.

Headset [Menu 3-5]

- **Change** : You can change the values of Profile submenus.

Handsfree [Menu 3-6]

- **Change** : You can change the values of Profile submenus.

A Group of Profiles submenus [Menu 3-x-2-x]

Profiles menu have the submenus as shown below.

- **Incoming alert type [Menu 3-x-2-1]**
Allows to alert for the incoming call for adjusting environment.
- **Ring type [Menu 3-x-2-2]**
Allows to set the ring type for adjusting environment.
- **Ring volume [Menu 3-x-2--3]**
Allows to set the ring volume for adjusting environment.
- **Message alert type [Menu 3-x-2-4]**
Allows to alert when receiving a message for adjusting environment.
- **Key volume [Menu 3-x-2-5]**
Allows to set the keypad volume for adjusting environment.

● **Note**

- If you set the Handsfree kit to the phone, you can't activate the vibration related with Incoming alert or Message alert menu. Therefore, in Handsfree menu, you can view the following submenus;
 - **Incoming alert** : Ring, Silent
 - **Message alert** : Beep, No alert

● **Note**

Automatic answer

- This function will be activated only when your phone is connected to the handsfree kit or headset.
 - **Disable** : The phone will not answer automatically.
 - **After 5 sec** : After 5 seconds, the phone will answer automatically.
 - **After 10 sec** : After 10 seconds, the phone will answer automatically.



You can set the following menus for your convenience and preferences.

1. Press [Menu] in standby mode.
2. Press for direct access to enter **Settings**.

Alarm clock [Menu 4-1]

You can set the phone to alarm at a specified within this menu.

Enable [Menu 4-1-1]

You can set the time (Hour and Minute) for raising the alarm.

1. Enter the menu.
2. Select Enable by pressing [Select], and then enter the alarm time you want.
3. Press [OK].
4. Select the repeat period: **Once**, **Daily**, **Weekly**, and **Monthly**.
5. If you set **Yes** in **Power off alarm**, the alarm signal sounds at the time you set even if the phone is turned off.

Disable [Menu 4-1-2]

You can cancel setting the alarm time.



1. Enter the menu.
2. Select **Disable** by pressing [Select].
3. "Done" message is displayed.
4. If you want to cancel, press [Yes]. If not, press [No].

Clock [Menu 4-2]

Date [Menu 4-2-1]

• Set date

In this menu, you can set the date of your phone.

1. Enter the menu.
2. Select **Set date** by pressing  [Select].
3. Enter the number you want to set the date.
4. Press  [OK].

• Date format

You can set the date format in this menu.



Time [Menu 4-2-2]

The phone has its own clock. In this menu you can set the time and select between the 12-hour or 24-hour time formats.

1. Enter the menu.
2. Scroll to highlight **Time** by pressing  [Select].



• Set time:

You can set time of your phone in this menu.

1. Select **Set time** by pressing  [Select].
2. Enter the number you want to set the time.
3. Select the **AM/PM** you want to set the time format by pressing  key.
4. Press  [OK].

• Time format:

Your can select time format between 12-hour or 24-hour.

1. Scroll to highlight **Time format** by pressing  [Select].
2. Select 12 hour or 24 hour you want by pressing  [Select].

Phone settings [Menu 4-3]

You can set the phone figures you want. Scroll to highlight **Phone settings** menu, and then press  [Select].

Display [Menu 4-3-1]

- **Call :**

You can set the animation as making a call.

- **Wallpaper :**

You can select background picture in a standby mode.

- **Internet connect :**

You can set the animation as connecting Internet.

- **Power on :**

You can set the animation as turning on a phone.

- **Power off :**

You can set the animation as turning off a phone.

- **Welcome note :**

You can set the displayed message as turning on a phone.

- **Greeting note :**

If you select **Yes**, this menu allows you to select the standby display. In text mode, you can edit the text.

- **Backlight :**

You can set the light-up duration you want whenever you press a key.

- **LCD contrast**

You can set the brightness of LCD you want by pressing  ,  .

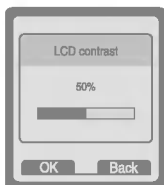

Voice dial [Menu 4-3-2]

- **Automatic** : You can enter voice dial mode whenever you open folder.
- **Manual** : You can enter voice dial mode by pressing ***99** key for a long time.

LED indicator [Menu 4-3-3]



You can check the network status through Call indicator Light. If you are in service area, Call Indicator Light will flicker to Green. On the contrary, if you are in no service area, this light will change to Red.

Furthermore, you can set the color of light depending on Group in phonebook.

• Incoming call [Menu 4-3-3-1]

You can set the one of the colors such as red, blue, yellow, orange and so on.

• Standby [Menu 4-3-3-2]

You can check the network status by LED color in a standby mode.

Language [Menu 4-3-4]

You can select the language will be displayed.

Call settings [Menu 4-4]

You can set the menu relevant to a call by pressing **9** [Select] in Setting menu.

Minute minder [Menu 4-4-1]

If you select **Yes**, you can check the call duration by beep sound every minute during a call.

Answer mode [Menu 4-4-2]

• Any key [Menu 4-4-2-1]

If you select this menu, you can receive a call by pressing any key except **69** key.

• Folder open [Menu 4-4-2-2]

If you select this menu, you can receive an incoming call by only opening folder.

Send number [Menu 4-4-3] (network and subscription dependent)

- **Yes [Menu 4-4-3-1]**

If you select this, you can send your phone number to the other party. That is, your phone number will be displayed on receiver's phone.

- **No [Menu 4-4-3-2]**

If you select this, you can't send your phone number.

Call waiting [Menu 4-4-4] (network dependent)

If this service is available, you can accept a waiting (incoming) call. If this service is not available, you cannot recognize the waiting (incoming) call.

- **Activate [Menu 4-4-4-1]**

Activating the corresponding service.

- **Deactivate [Menu 4-4-4-2]**

Deactivating the corresponding service.

- **Check status [Menu 4-4-4-3]**

Checking the Status of the service.

Auto redial [Menu 4-4-5]

- **Yes [Menu 4-4-5-1]**

When this function is set on, your phone will make up to 10 attempts for a call after not connecting.

- **No [Menu 4-4-5-2]**

Your phone will not make any attempts to connect the call after not connecting.

Select line [Menu 4-4-6]

This function is only used if **Two line service** supported by the Service Provider. Two independent phone numbers are registered for the phone. This function provides you with the selection the currently used phone number. If this function is supported by your service provider, the following menu will be displayed.

- **Line 1** : Select Line 1 as the current phone number.
- **Line 2** : Select Line 2 as the current phone number.

Next incoming [Menu 4-4-7] (network dependent)

In case of Single Numbering Service, you can use the phone and a connected PC to send and receive fax, data, and voice. If you select the mode, you can receive data, fax, or voice each mode. Once you enter this menu, you following options are displayed.

- **Voice**
You can receive the voice call.
- **Data**
You can receive the data call.
- **Fax**
You can receive the fax call.

● Note

- Single numbering service means that the number of fax or data service is identical with the number of voice service. And, these modes depend on network feature.

CUG (Closed User Group) [Menu 4-4-8]

(network dependent)





Use this function to restrict usage of the phone to calls with numbers that belong to certain user groups. When this function is used every outgoing call is associated with a group index. If a group index is specified, it is used for all outgoing calls. If no group index is specified, the network will use the preferential index (a specific index that is stored in the network).

- A. Select** : Setting the selected CUG Index.
- B. Edit** : Editing the CUG name and CUG Index.
- C. Delete** : Deleting the selected CUG.
- D. Clear all** : Deleting All CUG.

Security settings [Menu 4-5]

PIN code [Menu 4-5-1]

In this menu, you can set the phone to ask for the PIN code of your SIM card when the phone is switched on. If this function is activated, you'll be requested to enter the PIN code.

1. Press  [Menu] in standby mode.
2. Press  key for direct access or use  and  to enter **Settings**.
3. Scroll to highlight **Security settings** menu.
4. Select **PIN code** by pressing  [Select].
5. You can view the following submenus.
 - **Enable** : Enable PIN code request.
 - **Disable** : Disable PIN code request.

Call barring [Menu 4-5-2]

The Call barring service prevents your phone from making or receiving certain category of calls. This function requires the call barring password. You can view the following submenus.

- **All outgoing:**

The barring service of all outgoing calls.

- **Outgoing Intl:**

The barring service of all outgoing international calls.

- **Outg. intl roam:**

The barring service of all international outgoing calls except home network.

- **All incoming:**

The barring service of all incoming calls

- **Inc when roam:**

The barring service of all incoming calls when roaming

- **Cancel all barring:**





You can cancel all barring service.

- **Change passwd:**

You can change the password for Call Barring Service.

FDN setting [Menu 4-5-3] (SIM dependent)

You can restrict your outgoing calls to selected phone number. The numbers are protected by your PIN2 code.

1. Press  [Menu] in standby mode.
2. Press  key for direct access or use  and  to enter **Settings**.
3. Scroll to highlight **Security settings** menu.
4. Select PIN code by pressing  [Select].
5. If the PIN 2 code is correct, you can view the following submenus.

• Fixed dial num [Menu 4-5-3-1]







- **On** : You can restrict your outgoing calls to selected phone number.
- **Off** : You can call without restricting phone number.

• Number list [Menu 4-5-3-2]

You can view the number list saved as Fixed dial number.

Change code [Menu 4-5-4]

You can change the access codes: **PIN, PIN2, Security code**.

1. Press  [Menu] in standby mode.
2. Press  key for direct access or use  and  to enter **Settings**.
3. Scroll to highlight **Security settings** menu.
4. Select **Change code** by pressing  [Select].
5. If you want to change the PIN/PIN2/Security code, input your original code, and then press  [OK].
6. Input new PIN/PIN2/Security code, and verify the them.

Network settings [Menu 4-6]

You can select the network which you will be registered either automatically or manually. Usually, the selection of the network used by the handset is automatic.

Automatic [Menu 4-6-1]

The phone automatically selects network which is available in the area.

Manual [Menu 4-6-2]

The phone will find the list of available networks and show you them. Then you can select the network which you want to use if this network has a roaming agreement with your home network operator.

Restore factory settings [Menu 4-7]

You can set the handset to the default configuration by selecting this menu. In addition, you need Security code to activate this function.

● How to use Handfree portable:

If you want to use the handsfree portable(earphone), please the button for a long time after inserting it to the connector when incoming a call.



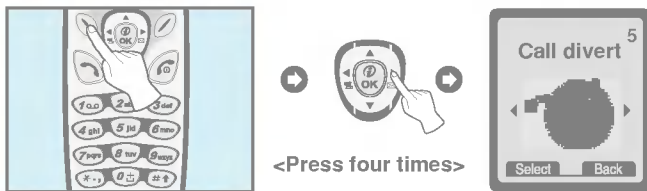

Call divert [Menu 5]

(network and subscription dependent)

Accessing the Menu



The Call divert service allows to divert incoming voice calls, fax calls, and data calls to another number. For details, contact your service provider.

1. Press  [Menu] in standby mode.
2. Press  for direct access or use  and  to enter **Call divert**.

All voice calls [Menu 5-1]

Diverts voice calls unconditionally.

If busy [Menu 5-2]

Diverts voice calls when the phone is in progress.

If not answered [Menu 5-3]

Diverts voice calls which you do not answer.

If out of reach [Menu 5-4]

Diverts voice calls when the phone is switched off or out of range.

All data calls [Menu 5-5]

Diverts to a number with a PC connection unconditionally.

All fax calls [Menu 5-6]

Diverts to a number with a fax connection unconditionally.

The submenus [Menu 5-x-x]

Call divert menus have the submenus as shown below.

Enable [Menu 5-x-1]

Activating the corresponding service.

- **Voicemail box [Menu 5-x-x-1]**

Forwards to message center. This function doesn't include All data calls and All fax calls menus.

- **Other number [Menu 5-x-x-2]**

Inputs the number for diverting.

- **Favorite [Menu 5-x-x-3]**

You can check 5 diverted numbers.

● Note

- You can select the number you want in **Favorite** menu.

Disable [Menu 5-x-2]

Deactivating the corresponding service.

Check status [Menu 5-x-3]

Checking the Status of the corresponding service.

Cancel all diverts [Menu 5-7]

Cancels all call divert service.





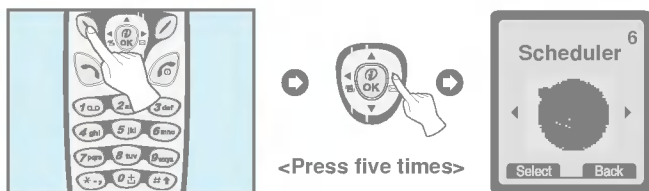



Scheduler [Menu 6]

Accessing the Menu



When you enter this menu a Calendar will show up. On top of the screen there are sections for date and icons. Whenever you change the date, the calendar will be updated according to the date. And square cursor will be used to locate the certain day. If you see under bar on the calendar, it means that there is a schedule that day. This function helps to remind you of your schedule and memo. The phone will sound an alarm tone if you set this for the note.

For changing the day, month, and year.

		Yearly			Weekly
		Monthly			Daily

Note

- Your phone should be switched on to use this function.

New [Menu 6-1]

You can edit maximum 30 characters. You can take a note. You can choose the following types of note. You can make up to maximum 20 notes.

Schedule [Menu 6-1-1]

Input the subject, the schedule time, the repeat time, alarm time by pressing  [Select].



• Repeat

- **Once** : no repeat.
- **Daily** : repeat schedule daily for 5 days.
- **Weekly** : repeat schedule weekly for 5 weeks.
- **Monthly** : repeat schedule monthly for 5 months.
- **Yearly** : repeat schedule yearly for 5 years.



• Alarm time

- **On time** : alarm on time you set already.
- **Before 10 Min** : alarm before 10 minutes from the schedule you set already.
- **Before 30 Min** : alarm before 30 minutes from the schedule you set already.
- **Before 1 hour** : alarm before 1 hour from the schedule you set already.
- **Before 1 day** : alarm before 1 day from the schedule you set already.

Memo [Menu 6-1-2]

1. Select **New** by pressing  [Select].
2. Scroll to highlight **Memo**.
3. Press  [Select].
4. Input the memo and then press  [Select].

View day [Menu 6-2]

Shows the note for the chosen day. Use  ,  to browse through the note lists. If you set alarm for the note, Alarm watch is displayed. Press  [Options] to delete, edit the note you selected.

Options [Menu 6-2-1]



- **Edit**

You can edit the subject, time, the repeat time and alarm time by pressing  [Select].

- **Delete**

You can delete the note.

View all [Menu 6-3]

Shows the notes that are set for all days. Use  ,  to browse through the note lists. You can use the same menu as "View day" by pressing  [Options].

Delete last [Menu 6-4]

You can delete for the last schedule already is notified you.

Delete all [Menu 6-5]

You can delete for the all note(s).

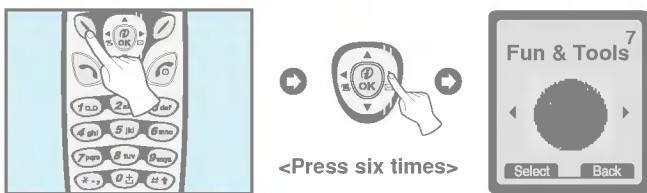

My folder [Menu 7-1]

You can view, delete, and control download contents.

Picture [Menu 7-1-1]

Icon [Menu 7-1-2]

Animation [Menu 7-1-3]

Ring tone [Menu 7-1-4]

Sound [Menu 7-1-5]

The submenus for each main one [Menu 7-1-x-x]

- Edit title [Menu 7-1-x-1]

You can edit the title for each download content.

- Delete [Menu 7-1-x-2]

You can delete each download content.

- Delete all [Menu 7-1-x-3]

You can delete all download contents.

Game [Menu 7-2]

The phone offers you the games to play with.

Note

- The control keys are different depending on a game. However, each one has an introduction to explain the main control keys. The rest ones are as follows.







[Common Key Function]

 ,  : Back

 : Pause or resume a game

Ring composer [Menu 7-3]

You can compose a ring tone melody which you want. When you enter this function, the tone that you created previously is displayed. To enter a new or edit an existing tone:

1. Enter the desired notes. ( ~  : CDEFGAB)
2. To adjust the characters of the note, do as follows:
 - **Note duration** :  shorten(+) and  lengthens(-) the duration of the note or rest.
 - **Rest** :  inserts a rest of the same duration as the previous note.
 - **Octave** :  sets the octave for new notes.
 - **Pitch** :  makes the note sharp.

Graphic editor [Menu 7-4]

You can edit a graphic picture which you want.

Unit converter [Menu 7-5]



This converts any measurement into a unit you want. There are 4 types that can be converted into units: **Length, Area, Weight, and Volume.**

1. You can select one of four unit types by pressing [Next] key.
2. Select the standard value by using , .
3. Select the unit you want to convert by pressing and .
4. You can check the converted value for the unit you want. Also, you can input the decimal number by pressing .
5. Press key or [Back] key if you want to end the process for converting the value.

Calculator [Menu 7-6]

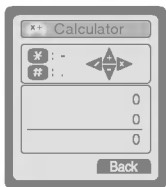





This contains the standard functions such as +, -, *, ÷ : **Addition, Subtraction, Multiplication, and Division.**

1. Input the numbers by pressing numeric keys.
2. Use a navigation key to select a sign for calculation.
3. Then input the numbers followed by the sign.
4. You can view the result by pressing [Result] key.
5. If you want to continue the calculation, repeat the process.
6. Use [Back] key to erase any numbers or signs. Press key if you want to end the calculation process.
7. If you press key, you can input a minus number. In addition, if you press key, you can input a decimal number.

World time [Menu 7-7]

You can view the time for each city around the world. Also, you can set the current time to city time you select.

1. Select the city belonged to the time zone by pressing  ,  key.
2. If you use  ,  key, you can check the other city belonged to same time zone of country.
3. You can set the current time to the city time you select.
4. Press  [Back] key to exit the menu.

● PC Sync

PC Sync is a program for data exchange between PC and phone by data cable. Therefore, if you want to use this function, you have to buy accessory kit. For more information, you can use the guide of PC Sync Help file in CD.

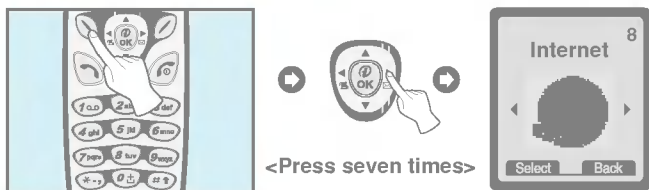



Your phone supports services based on Wireless Application Protocol(WAP). You can access services supported by your network. The services menu allows you to get the information such as news, weather reports, and flight times.

Home [Menu 8-1]

Return to homepage. The homepage may be the site which is defined in activated profile. It will be defined by Service Provider if you don't make in activated profile.

Bookmarks [Menu 8-2]

When you enter this menu, you can see the bookmarks. Then press  to access available option, or press  to exit it.

- **Connect** : Connect to selected bookmark.
- **Add new** : You can add new bookmark.
- **Edit** : Edit the address of selected bookmark.
- **Delete** : Erase selected bookmark from the bookmark list.

Push messages [Menu 8-3]

You can manage an inbox and a message to use push service.

Inbox [Menu 8-3-1]

You can read or delete the push messages.

Receive [Menu 8-3-2]

You can set the option whether you will receive the message or not.

Profiles [Menu 8-4]

You can make up to 5 profiles and activate only one out of them. Scroll to desired profile and press  to access available options.

- **Activate [Menu 8-4-1-1]**

Activate the selected profile.

- **Settings [Menu 8-4-1-2]**

The submenus must be set up before you can browse WAP sites.

- **Homepage [Menu 8-4-1-2-1]**

This setting allows you to enter the address (URL) of site you want to use as homepage. You do not need to type “http://” at the front of each URL as the WAP Browser will automatically add it.

- **Display images [Menu 8-4-1-2-2]**

You can select whether images on WAP cards are displayed or not.

- **Conn. type [Menu 8-4-1-2-3]**

The options for connection type are Temporary or Continuous and depend on the gateway you are using.

- Continuous [Menu 8-4-1-2-3-1]**

A confirmed delivery mechanism but generates more network traffic.

- Temporary [Menu 8-4-1-2-3-2]**

A non-confirmed (connectionless) service.

- **Conn. security [Menu 8-4-1-2-4]**

The options are **On and Off** depending on the gateway you are using.

- **Gateway info. [Menu 8-4-1-2-5]**

Almost WAP gateways do not require User ID and Password. If your gateway doesn't have ones, those should be provided by your network. Also, they must be set up before browsing WAP sites.

- Data setting [Menu 8-4-1-2-6]

IP address : Input the IP address of the WAP gateway you access.

Dial number : Input the telephone number to dial to access your WAP gateway.

Call type : Select the type of data call.: Analogue or Digital(ISDN).

Call speed : The speed of your data connection.

User ID : The users identity for your dial-up server (and NOT the WAP gateway).

Password : The password required by your dial-up server (and NOT the WAP gateway) to identify you.

- Linger time [Menu 8-4-1-2-7]

You need to select one of four timeout periods, after which the WAP Browser will report a failure to send data (for example because the WAP gateway is not responding).

You can continue to browse WML cards in the current deck or stored in the handset cache of memory effectively 'offline' but when you select a link to card outside the current deck and not held in the cache you will activate a new data call.

• Rename [Menu 8-4-1-3]

Edit the Profile Name.

• E-mail server [Menu 8-4-1-4]**- Connect [Menu 8-4-1-4-1]**

Connect to the E-mail server that you configured.

- Edit address [Menu 8-4-1-4-2]

Edit the E-mail address.

Go to URL [Menu 8-5]

You can move to the site you want. In this menu, you can also edit the site address.

Cache settings [Menu 8-6]

You can remove the contents of Cache memory or change the Cache mode.

Clear cache [Menu 8-6-1]

The contents of Cache memory will be removed.

Cache check [Menu 8-6-2]

You can change the time for checking the Cache memory.

- **Always [Menu 8-6-2-1]**

The cache is always checked whenever URL is loaded or URL is navigated.

- **Start only [Menu 8-6-2-2]**

The cache is only checked when the WAP is started.

- **Off [Menu 8-6-2-3]**

The cache is never checked. In this setting the cache can be seen as disabled.

Security certif. [Menu 8-7]

A list of the available certificates is shown.

Reset profiles [Menu 8-8]

You can reset profiles to return to original settings.

If you are on line, you can view the following these menus.

■ **Home**

Same to [Menu 8-1]

■ **Reload**

Reloads the current page.

■ **Bookmarks**

Same to [Menu 8-2]

■ **Save as Bookmark**

You can save a site as bookmark.

■ **Go to URL**

You can move to the site you want. In this menu, you can also edit the site address.

■ **Go to email server**

You can move to the E-mail server that you configured.

■ **Set as email server**

You can set the address of current site as E-mail server.

Your service provider can offer special application through SIM card, such as home banking, stock market, etc. If you are registered for one of these services, the service name will appear at the end of the Main Menu. With the SIM Services menu your phone is future-proof and will support additions to your service provider's service. For more information contact your service provider.

To be able to data or fax service, you need the communicate software such as a data or a fax program. Before using these functions, you need to connect your phone to a computer or make sure that your phone is in connection with a compatible device.

Sending Data or Fax Calls

1. Connect your computer to the phone.
2. After starting the communicate software, make a call and transmit a data or fax.
3. After the data or fax transmission, you can end the call by just ending of the communicate software, pressing  [End] or by closing the folder.

Receiving Data or Fax Calls

If you have separate numbers for voice, data and fax calls, your phone recognizes the type of call.

Receiving Data or Fax Calls - Separate numbers (Multi-numbers)

To use a data or a fax service, the display shows which type of call you are receiving.

To receive a data or fax call



1. Connect your computer to the phone.
2. After starting the communicate software, accept a call and receive a data or fax (if it is not answered automatically).
3. After the data or fax reception, you can end the call by just ending of the communicate software, pressing  [End] or by closing the folder.

Receiving Data or Fax Calls - Single number

If you have a SIM card that does not support separate voice, data and fax numbers, the phone does not recognize the type of incoming call.

To use a data or a fax service, make sure that you want to receive a data or fax call mode. You first have to set the phone to one of these options in the call mode (Settings → Call Setting → Next Incoming) sub menu.

To receive a data or fax call



1. Press  [Menu] in standby mode.
2. Select the Settings → Call setting → Next Incoming.
3. Select the call type you want (Voice, Data or Fax) and press  [OK].
4. Connect your computer to the phone.
5. After starting the communicate software, accept a call and receive a data or fax (if it is not answered automatically).
6. After the data or fax reception, you can end the call by just ending of the communicate software, pressing  [End] or by closing the folder.

Once you have set your phone for a specific incoming call, it remains set until you change it.



The menu displayed on the handset screen during a call is different to the default main menu reached from the idle screen, and the options are described here.

1 DURING A CALL



1-1 Putting a Call on Hold

You can place a call on hold or retrieve by just pressing the  [Send] key. When a call is made or answered, press the  [Send] key to place it on hold. When a call is held, press the  [Send] key to make it active.

1-2 Making a Second Call

You can get a dial number from phonebook to make a second call. Press  [Names] key then select **Search**. To save the dial number into phonebook during call, press  [Names] key then select **Add Entry**.

1-3 Swapping Between Two Calls



To switch between two calls, select the  [Menu] key, then select Swap or just press  [Send] key.

You can make one of two calls focused by pressing up/down arrow key. If you want to end one of two calls, make the call you want to end focused, then press  [End] key when the call you want to end is focused.

1-4 Answering an Incoming Call

To answer an incoming call when the handset is ringing, simply press the  [Send] key.



The handset is also able to warn you of an incoming call while you are already in a call. A tone sounds in the earpiece, and the display will show that a second call is waiting. This feature, known as Call Waiting, is only available if your network supports it. For details of how to activate and deactivate it see Call waiting [Menu 4-4-4].

If Call Waiting is on, you can put the first call on hold and answer the second, by pressing  [Send] or by selecting the  [Menu] key, then **Hold & Answer**.



You can end the current call and answer the waiting call by selecting the  [Menu] key, then **End & Answer**.

1-5 Rejecting an Incoming Call

When not in a call you can reject an incoming call without answering it by simply pressing the  [End] key.

When in a call you can reject an incoming call by pressing the  [Menu] key and selecting **Multiparty/Reject** or by pressing the  [End] key.

1-6 Muting the Microphone

You can mute the microphone during a call by pressing the  [Menu] key then selecting **Mute**. The handset can be unmuted by pressing the  [Unmute] .

When the handset is muted, the caller cannot hear you, but you can still hear them.

1-7 Switching DTMF Tones on During a Call

To turn DTMF tones on during a call, for example, to allow your handset to make use of an automated switchboard, select the  [Menu] key, then **DTMF On**. DTMF tones can be turned off the same way.

1-8 Calling up the Main Menu

The Messages and SIM Tool kit main menu options can be reached from the in-call menu by selecting the  [Menu] key, then **Main Menu**. SIM Tool kit menu is shown only when SIM in the handset supports SIM Tool kit service.



2 Multiparty or Conference Calls

The multiparty or conference service provides you with the ability to have a simultaneous conversation with more than one caller, if your network service provider supports this feature.

A multiparty call can only be set up when you have one active call and one call on hold, both calls having been answered. Once a multiparty call is set up, calls may be added, disconnected or separated (that is, removed from the multiparty call but still connected to you) by the person who set up the multiparty call. These options are all available from the in-call menu and are listed in Section.

The maximum callers in a multiparty call is five. Once started, you are in control of the multiparty call, and only you can add calls to the multiparty call.

2-1 Making a Second Call

You can make a second call while you are already in a call. To do this, enter the second number and press  [Send]. When you get second call the first call is automatically put on hold. You can swap between calls by selecting the  [Menu] key then **Swap**.

2-2 Setting up a Multiparty Call

You can connect a call on hold to the currently active call to form a multiparty call by selecting the  [Menu] key then **Multiparty/Join all**.

2-3 Putting the Multiparty Call on Hold

To put a multiparty call on hold, select the  [Menu] key then **Multiparty/Hold all**.



2-4 Activate the Multiparty Call on Hold

To make a multiparty call on hold active, select the  [Menu] key then **Multiparty/Join all**.

2-5 Adding Calls to the Multiparty Call

To join an active call to the held multiparty call, select the  [Menu] key then **Multiparty/Join all**.

2-6 Displaying Callers in a Multiparty Call

To scroll through the numbers of the callers who make up a multiparty call on the handset screen, press  and  keys.



2-7 Putting a Member of a Multiparty Call on Hold

To place one selected caller (whose number is currently displayed on-screen) of a multiparty call on hold, select the  [Menu] key then **Multiparty/Exclude**.

2-8 A Private Call in a Multiparty Call

To have a private call with one caller of a multiparty call, display the number of the caller you wish to talk to on the screen, then select the  [Menu] key and **Multiparty/Private** to put all the other callers on hold.

2-9 Ending a Multiparty Call

The currently displayed caller of a multiparty call can be disconnected by pressing the  [End] key. To end a multiparty call, press the  [Menu] key then select **Multiparty/End multiparty**.

Selecting the  [Menu] key then **Multiparty/End all**, will end all the active and held calls.

2-10 Explicit Call Transfer (ECT)

If you have one caller on hold and another active call, you may connect one call party to another call party and then leave the call. This is done by selecting the **Multiparty/Transfer** option from the in-call menu.

When using this unit, basic safety precautions as below should be always followed.

- Do not disassemble this unit. (Take it to a qualified service technician when repair work is required.)
- Away from electrical appliance such as a TV, radio or personal computer.
- The unit should be situated from heat sources such as radiators or cookers.
- Do not drop.
- Do not subject this unit to mechanical vibration or shock.
- The coating of the phone may be damaged if covered with wrap or vinyl wrapper.
- Use dry cloth to clean the exterior of the unit. (Do not use solvent such as benzene, thinner or alcohol.)
- Do not subject this unit to excessive smoke or dust.
- Do not keep the phone next to credit cards or transport tickets; it can be affect the information on the magnetic strips.
- Do not tap the screen with a sharp object; otherwise, it may damage the phone.
- Do not expose the phone to liquid or moisture.
- Use the accessories like an earphone cautiously. Do not touch the antenna unnecessarily.

■ Caring for the Battery

- You do not need to completely discharge the battery before recharging. Unlike other battery systems, there is no memory effect that could compromise the battery's performance.
- Use only LG batteries and chargers. LG chargers are designed to maximize the battery life.
- Do not disassemble or short-circuit the battery pack.
- Keep the metal contacts of the battery pack clean.
- Replace the battery when it no longer provides acceptable performance. The battery pack may be recharged hundreds of times until it needs replacing.
- Recharge the battery if it has not been used for a long time to maximize usability.
- Do not expose the battery charger to direct sunlight or use it in high humidity, such as the bathroom.
- Do not leave the battery in hot or cold places, this may deteriorate the battery performance.



