



ENGLISH

GPRS Phone

USER'S MANUAL

MODEL: G5300

Please read this manual carefully
before operating your set.
Retain it for future reference.

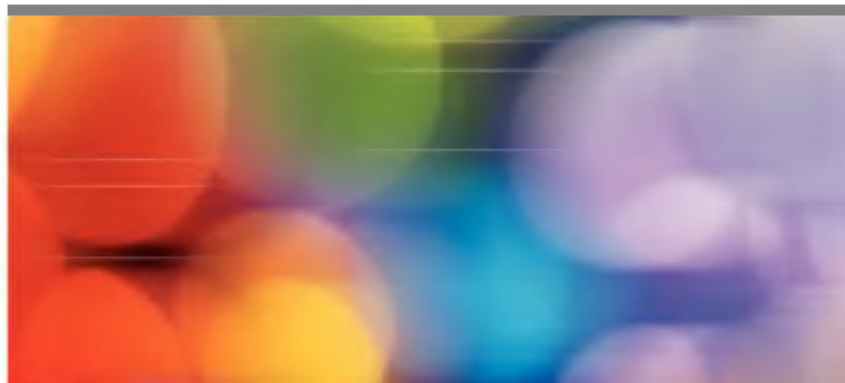



GPRS Phone

USER'S MANUAL

MODEL: G5300

Please read this manual carefully
before operating your set.
Retain it for future reference.

G5300 has a polished style which provides users with a better feel and more convenience.



For Your Safety

All radio transmitters carry risks of interference with electronics in close proximity.



GSM Phones must be switched off at all times in an aircraft.



Do not activate near petrol stations, fuel depots, chemical plants or blasting operations.



Switch off the phone in any area where you are required by special regulations. For example, the phone is not allowed to be used in hospital because pacemakers and hearing aids can be affected.



Minor interference may affect TVs, radios, PCs, etc.



Do not hold the phone in your hand while driving.



Do not dismantle phone or battery.



Keep the phone in a safe place out of children's reach since it contains the detachable small parts and create a choking hazard.



Do not touch the charger with wet hands.



For your safety, use ONLY specified ORIGINAL batteries and chargers.

Please note:



Unusable batteries should be disposed of in accordance with relevant legislation.



Only use ORIGINAL accessories to avoid damage to your phone.



Emergency call may not be available under all cellular networks. Therefore, you should never depend solely on the phone for essential communications such as medical emergencies.

Important Information

This user's guide contains important information on the use and operation of this phone. Please read all the information carefully for optimal performance and to prevent any damage to or misuse of the phone. Any changes or modifications not expressly approved in this user's guide could void your warranty for this equipment.

Contents

Overview

Accessories	15
Part of the Phone	17
• Front of the Phone	17
• Rear of the Phone	18
Key Description	19
• Alphanumeric Keys	21

Display Information

Display Information	22
• On-Screen Icons	22

Getting Started

Installation	24
• Inserting the SIM Card	24
• Installing the Battery	25
• Charging the Battery	26
• Disconnecting the charger	27
Powering On Sequence	28
• To get started with the phone	28
• To turn off the phone	28
Access Codes	29
• PIN code (4 to 8 digits)	29
• PIN2 code (4 to 8 digits)	29
• PUK code (4 to 8 digits)	29
• PUK2 code (4 to 8 digits)	30
• Security code (4 to 8 digits)	30

Accessing the Menu

Phonebook	31
Menu Tree	32
Messages [Menu 1]	34
• Write message [Menu 1-1].....	34
• Inbox [Menu 1-2]	39
• Outbox [Menu 1-3]	40
• Info service [Menu 1-4]	41
• Voice mail [Menu 1-5]	43
• Namecard [Menu 1-6]	44
• Templates [Menu 1-7]	44
• Delivery reports [Menu 1-8]	45
• Settings [Menu 1-9]	45
• Memory status [Menu 1-0]	46
Call Register [Menu 2]	47
• Missed calls [Menu 2-1]	47
• Received calls [Menu 2-2]	47
• Dialed calls [Menu 2-3].....	47
• All calls list [Menu 2-4]	47
• Delete recent calls [Menu 2-5]	47
• Call charge [Menu 2-6].....	48
• GPRS information [Menu 2-7].....	51
Profiles [Menu 3]	52
• Vibrate only [Menu 3-1].....	52
• Quiet [Menu 3-2]	52
• General [Menu 3-3]	53
• Loud [Menu 3-4]	53
• Headset [Menu 3-5]	53
• Car [Menu 3-6]	54

Settings [Menu 4]	56
• Alarm clock [Menu 4-1]	56
• Date & time [Menu 4-2]	57
• Phone settings [Menu 4-3]	58
• Call settings [Menu 4-4]	60
• Security settings [Menu 4-5]	62
• Network settings [Menu 4-6]	66
• Reset setting [Menu 4-7]	66
Call Divert [Menu 5]	67
• All voice calls [Menu 5-1]	67
• If busy [Menu 5-2]	67
• If no reply [Menu 5-3]	67
• If out of reach [Menu 5-4]	67
• All data calls [Menu 5-5]	67
• All fax calls [Menu 5-6]	68
• Cancel all [Menu 5-7]	69
Organizer [Menu 6]	70
• Scheduler [Menu 6-1]	70
• Phone book [Menu 6-2]	73
Fun & Tools [Menu 7]	82
• My folder [Menu 7-1]	82
• Game [Menu 7-2]	83
• Melody composer [Menu 7-3]	84
• Graphic editor [Menu 7-4]	84
• Unit converter [Menu 7-5]	85
• Calculator [Menu 7-6]	86
• World time [Menu 7-7]	86

WAP services [Menu 8]	87
• Home [Menu 8-1]	87
• Bookmarks [Menu 8-2]	87
• Push messages [menu 8-3]	87
• Profiles [Menu 8-4]	88
• Go to URL [Menu 8-5]	90
• Cache settings [Menu 8-6]	91
• Security certifications [Menu 8-7]	91
• Reset profiles [Menu 8-8]	91
Internet On-line menu	92

Additional Functions

How to Use Data and Fax call	93
• Sending Data or Fax Calls	93
• Receiving Data or Fax Calls	93
In call Menu	95
1. During a call	95
2. Multiparty or Conference Calls	98
Care and Maintenance	101
Technical Data	103

Check to make sure that you have all the parts shown below.



Handset



Standard Battery



Neckstrap

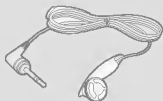

Portable Handsfree

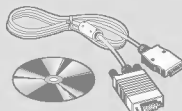

Data Kit/CD



Card(s)



User's manual



Travel Adapter

<Optional Accessories>

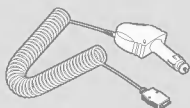

Cigar Lighter Adapter



Handsfree Kit

- Information and specification in this menu is subject to change without prior notice.
- Accessories may be different in different regions; please check with our regional service company or agent for further enquiries.

Front of the Phone

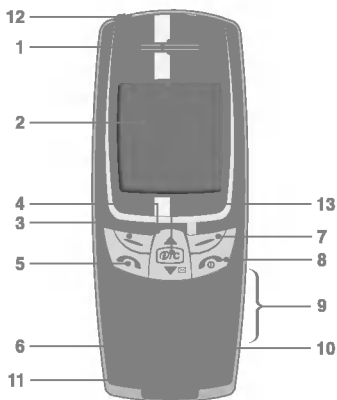

- | | |
|-------------------|-----------------------------|
| 1 Earpiece | 8 END/PWR keys |
| 2 Display Screen | 9 Numeric Keys |
| 3 Soft Left Key | 10 Hash Key |
| 4 Navigation Keys | 11 Microphone |
| 5 Send Key | 12 Ear Microphone Connector |
| 6 Star Key | 13 WAP Hotkey/
Clear key |
| 7 Soft Right Key | |



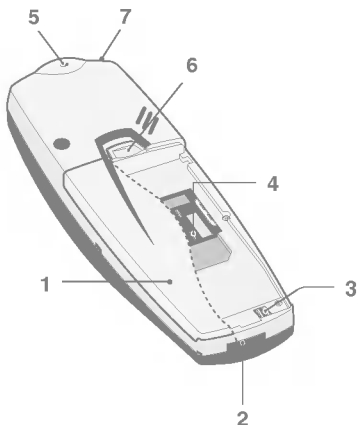







Rear of the Phone





- 1 Battery
- 2 Cable Connector/
Battery Charging Connector/
Hands-Free Car kit Connector
- 3 Battery Terminals
- 4 SIM Card Socket
- 5 Handstrap Hole
- 6 Battery Lock
- 7 Ear Microphone Connector

The following shows key components of the phone.

Keypad Description

Key	
	<p>Soft Left Key / Soft Right Key Each of these keys performs the function indicated by the text on the display immediately above it.</p>
	<p>WAP Hotkey / Clear key Used to connect to WAP directly by pressing this key. Used to delete character(s).</p> <p>Navigation Keys Used to scroll through name, phone numbers, menus or setting options.</p>
	<p>Used to enter Message menu directly.</p>
	<p>Used to scroll through names, phone numbers.</p>
	<p>Send Key You can dial a phone number and answer a call. If you press this key without entering a number, your phone shows the most recently dialed number.</p>
	<p>Numeric Keys These keys are used mainly to dial in standby mode and enter numbers or characters in editing mode. When you press these keys for a long time.</p> <ul style="list-style-type: none"> Used to call your voicemail box by . Used to call for international call by . Used to call Speed dials by from  to .

Key	
	Used to enter the vibration mode by pressing this key for a long time.
	Used to call by voice dial with long pressing this key. This key is also used as Ear mic. hook key when connecting Ear mic.
	END/PWR Key Used to end or reject a call. This key is also used as Power Key. Pressing and holding this key for a few seconds.















Alphanumeric Keys





The alphabet and numerical keypad mapping relation are listed as the following table.

Key	
	. , ' ? ! - & 1
	A B C 2 Ä À Á Â Ã Æ Ç a b c ä à á â ã ø ç
	D E F 3 È É Ê Ë def è é ê ë
	G H I 4 Î Ï Í G H I î ï í g h i î ï í
	J K L 5 j k l
	M N O 6 Ö Õ Ò Ó Ø Ñ m n o ö õ ò ó ø ñ
	P Q R S 7 p q r s
	T U V 8 Ü Û Û Ú ú t u v ü ù ú ú
	W X Y Z 9 w x y z
	0 [Space Key]

The screen displays several icons the following describe each of them you may see on the phone.

On-Screen Icons

Icon/Indicator	
	Tells you the strength of the network signal.
	Call is connected.
	You can use GPRS service.
	Shows that you are using a roaming service.
	Line 1/2 is in use for outgoing calls – If you subscribe to the Two Line Service.
	The alarm has been set and is on.
	Tells you the status of the battery.
	You have received a text message.
	You have received a voice message.
	You have received an E-mail.
	You can view your schedule.
	All audible signals are turned off.
	General menu in profile.
	Loud menu in profile.
	Quiet menu in profile.

Icon/Indicator	
	Headset menu in profile.
	Car menu in profile.
	You can divert a call.
	You can use Push message service through WAP.

Top Menu Icons

Icon	
	Messages
	Call Register
	Profiles
	Settings
	Call Divert
	Organizer
	Fun & Tools
	Wap services
	SIM Service

1 Inserting the SIM Card

Locate the SIM card socket in the back of the phone.
Follow the steps below to install the SIM card.

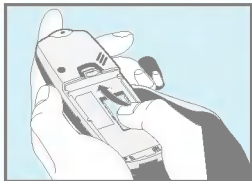

1. Remove the battery if attached.
2. Slide the SIM card into the slot, under the silvery holders, with the golden connectors facing down and the cut corner to the right.

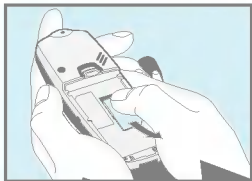

3. If you need to remove the SIM card, press the upper part of SIM card with the thumb, then carefully slide it out of the SIM card slot.

● Notice

- Before installing always make sure that the phone is switched off and remove the battery.
- The metal contact of the SIM card can be easily damaged by scratches. Pay special attention to the SIM card when you handle and install. Follow the instructions supplied with the SIM card.

② Installing the Battery



1. Place the battery on the back of the phone.

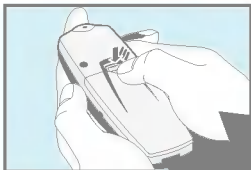

2. Push it until you hear a click.

3 Charging the Battery

To connect the travel adapter to the phone, you must have installed the battery.

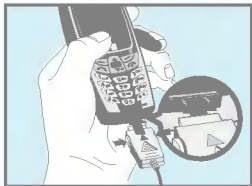

1. Insert one end of the travel adapter into the bottom of the phone.

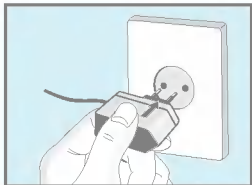

2. Connect the other end of the travel adapter to an AC wall outlet.
Use only the included packing charger.



● Warning

- Do not force the connector as this may damage the phone and/or the travel adapter.

4 Disconnecting the charger



Disconnect the travel adapter from the phone by pressing its side buttons.

● Notice

- The battery delivered with your phone has to be fully charged before using it.
- Do not remove your battery or the SIM card while charging.
- “Charging” is displayed on the screen after connecting the travel adapter. Only if the battery is totally empty, Back light is on without displaying “Charging”.
- The moving bars of battery icon will stop after charging completely.

① To get started with the phone



1. Press and hold  key until you hear a tone.
2. Depending on setting **PIN code request**, you can enter PIN code or not.
3. If your phone connects to a network, the network name will be displayed shortly.

② To turn off the phone

In standby mode, press and hold  key until you hear a tone.

You can use the access codes described in this section to avoid unauthorised use of your phone. The access codes (except PUK1 and PUK2 codes) can be changed by using [Menu 4-5-6].

PIN code (4 to 8 digits)

The PIN (Personal Identification Number) code protects your SIM card against unauthorised use. The PIN code is usually supplied with the SIM card. When **PIN code request** is set **Enable**, your phone will request the PIN code every time it is switched on. On the contrary, when **PIN code request** is set **Disable**, your phone connects to the network directly without the request PIN code.

PIN2 code (4 to 8 digits)

The PIN2 code, supplied with some SIM cards, is required to access some functions such as Advice of call charge, Fixed Dial number. These functions are only available if supported by your SIM card.

PUK code (4 to 8 digits)

The PUK(PIN Unblocking Key) code is required to change a blocked PIN code. The PUK code may be supplied with the SIM card. If not, contact your local service provider for the code. If you lose the code, also contact your service provider.

PUK2 code (4 to 8 digits)

The PUK2 code, supplied with some SIM cards, is required to change a blocked PIN2 code. If you lose the code, also contact your service provider.

Security code (4 to 8 digits)

The security code protects the unauthorised use of your phone. It is usually supplied with the phone. This code is required to delete all phone entries and to activate “Reset settings” menu. The default number is “0000”.

Phonebook

Accessing the Menu



To select a menu in phonebook, press [Names] in standby mode and then scroll to a desired item.

1	Search	Allows you to search for a specific name, number.
2	Add new	Allows you to add new names and numbers.
3	Speed dials	Allows you to assign up to 8 (2 ^{abc} - 9 ^{mpq}) one-touch dial allocations.
4	Voice list	Allows you to list phone numbers which is attached voice.
5	Caller groups	Allows you to show group list.
6	Copy all	Allows you to copy entries from your Phone memory to SIM card or from SIM card to Phone memory.
7	Delete all	Allows you to erase all the data in either your phonebook or the SIM card to the phone memory.
8	Settings	Allows you to set the memory and to search item by Variable, name and number.
9	Information	Allows you to check the status of memory, SDN (Service Dial Number), and Own number list.



1 Messages

- 1 Write message
- 2 Inbox
- 3 Outbox
- 4 Info service
- 5 Voice mail
- 6 Namecard
- 7 Templates
- 8 Delivery reports
- 9 Settings
- 0 Memory status



2 Call Register

- 1 Missed calls
- 2 Received calls
- 3 Dialed calls
- 4 All calls list
- 5 Delete recent calls
- 6 Call charge
- 7 GPRS information



3 Profiles

- 1 Vibrate only
- 2 Quiet
- 3 General
- 4 Loud
- 5 Headset
- 6 Car



4 Settings

- 1 Alarm clock
- 2 Date & time
- 3 Phone settings
- 4 Call settings
- 5 Security settings
- 6 Network settings
- 7 Reset setting



5 Call Divert

- 1 All voice calls
- 2 If busy
- 3 If no reply
- 4 If out of reach
- 5 All data calls
- 6 All fax calls
- 7 Cancel all



6 Organizer

- 1 Scheduler
- 2 Phone book



7 Fun & Tools

- 1 My folder
- 2 Game
- 3 Melody composer
- 4 Graphic editor
- 5 Unit converter
- 6 Calculator
- 7 World time



8 WAP services

- 1 Home
- 2 Bookmarks
- 3 Push messages
- 4 Profiles
- 5 Go to URL
- 6 Cache settings
- 7 Security certifications
- 8 Reset profiles



9 SIM Service

This menu depends on SIM and the network services.



This menu includes functions related to SMS (Short Message Service), voice mail, as well as the network's service messages.

Write message [Menu 1-1]

You can write and edit text message up to 918 characters. Also, you can check the number of characters.

1. Enter the **Messages** menu by pressing [Select].
2. If you want to write a new message, select **Write message** in the menu.
3. Input the message by using eZi text. For details, see eZi text (Page 37).
4. When you write the message,  key will be changed to symbol.
5. When you finish writing your message, press [Options].
Then following option menu will be displayed.

Send

Sends the text message.

1. If you want to send the text message, enter the number you want.
2. Your phone asks you to enter the number that you want to send it to.
3. After sending it, your phone asks whether you will store the edited message.



Save

Your phone asks whether you will save the edited message.

Use template

The template is pre-defined message. You can add the template of the list to the message when you edit it.

Use namecard

The items of the name card are a name, mobile, office, fax, and email. You can add a namecard to the message.

EMS function

Pictures (including animations) and sounds can be inserted in sending messages. Press [Option] key to insert, then following menu will be displayed.

- **Symbol**
- **Picture**
- **Animation**
- **Sound**

Note

- You can find received contents from other sender in My folder [Menu 7-1].



Dictionary

- **Add new**

If you add a word you use often, you can input it by pressing a key once for each character.

1. Enter the menu.
2. Scroll to highlight **Add new**, and then press [Select].
3. Input a word, and then press [Add].

- **List dictionary**

You can view the list you already saved words in a dictionary.

1. Enter the menu.
2. Scroll to highlight List dictionary, and then press [Select].
3. You can check the word list.
4. If you want to delete a word, press [Delete].
5. If you want to delete all words in a list, select **Delete all** at the bottom of the list by pressing [Select].



eZi-Text

The eZi text allows you to type easily and quickly. If you just press a key marked a character on the keypad, you can get a character you want. It is useful to make a word and a sentence. If you press  key, you can change the type of language.

Also, the phone supports four modes: **eZi Mode**, **Numeric mode**, **Capital mode**, and **Small mode**. If you want to change mode, press  key.

• How to Use in eZi mode

To input a character in eZi text mode, you just press each key once for a character you want.

For example, to write **Girl** in eZi mode;

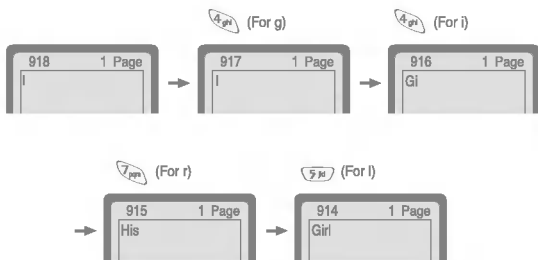

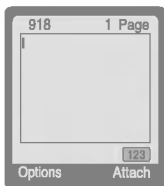

• How to use in Numeric mode

To input a number in Numeric mode, you press a number key displayed on the keypad.

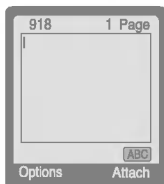

• How to use in Capital mode

To input Capital letter, you press a character key displayed on the keypad.

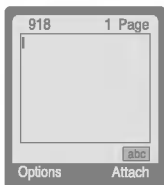

• How to use in Small mode



To input Small letter, you press a character key displayed on the keypad.

● Note

- If you want to delete a character, press  key in each mode.



Inbox [Menu 1-2]

When you receive a text message, your phone shows the symbol and stores it in the incoming message lists. Scroll to the desired message by using  ,  . In addition, you can see **Delete all** for deleting all incoming messages at the bottom of the list. While reading the message, press [Options] to access the available options.

Reply

You can reply to the sender by message.

Forward

You can forward the selected message to the other party.

Delete

The selected message is deleted.

Get number

If the selected message has the phone number, you can extract and save it in a phonebook. Also, you can call by this number.

Save attachments





You can save the attachment file such as symbol, picture, animation, and sound.

Return call

You can call back to the sender who sent the message automatically.



Outbox [Menu 1-3]

When you enter this menu, you can see the outgoing call list. Scroll to the desired message by using  ,  and press  to see the message. And if you want to exit **Outbox** menu, press .

In addition, you can see **Delete all** for deleting all outgoing messages at the bottom of the list.

While reading message, press [Options] to access the following submenus.

Forward

You can forward the selected message to the other party.

Delete

The selected message is deleted.

Get number



If the selected message has the phone number, you can extract and save it in a phonebook. Also, you can call by this number.



Info service [Menu 1-4] **(Dependent to network and subscription)**

Cell Broadcast messages (CB Message) are text messages by the network to GSM phone users. They provide general information such as weather reports, traffic news, taxis, pharmacies, and stock prices. Each type of information has the number; therefore, you can contact service provider. When you receive CB message, you can read it following sequence:

Read

1. When you receive CB message, it will be displayed on the screen. You can read the message by scrolling  ,  .
2. After reading the message, press  to return to the standby mode. In addition, you can save it until another message is reached.

Receive

• Yes

If you select this menu, your phone will receive the Cell Broadcast message.

• No

If you select this menu, your phone will not receive the Cell Broadcast message any more.



Alert

- **Yes**

If you select this menu, your phone will beep when Cell broadcast message is received.

- **No**

If you select this menu, your phone will not beep despite Cell broadcast message is received.

Languages

You can select the language you want. Then your phone will receive the cell broadcast message in your chosen language.

Topics (Dependent to network and subscription)

- **Add new**

If you select this menu, you will add the CB message category in Phone memory with its nickname.

- **View list**

If you select this menu, you can see CB message category which you added. If you press [Option], you can edit and delete CB message category which you added.

- **Active list**

You can select the CB message category in active list by pressing [Select].



Voice mail [Menu 1-5]

You can listen to your voice message(s) and get the voicemail centre number.

Listen to voice mail

You can call voicemail centre if you want to listen to voice message.

Voice mail centre

You can get the voicemail if this feature is supported by the network service provider. When new voicemail is arrived, the symbol will be displayed on the screen. Please check with your network service provider for details of their service in order to configure the handset accordingly.

1. Press key for  a long time in standby mode.
2. You can check the following submenus.

- **Home**

The number dialed on the home network to listen to voicemail.

- **Roam**

The number dialed when other networks to listen to voicemail.



Namecard [Menu 1-6]

It's for editing the namecard. The items of the namecard are a name, mobile, office, fax, and email.

- **Edit** : You can edit a namecard.
- **Delete** : You can delete a namecard.

Templates [Menu 1-7]

It's for editing pre-defined messages. You can see 11 pre-defined messages in the list. You can save 6 templates before you edit. But you can change them. The others are **<empty>**.

- **Edit** : You can edit a template.
- **Reset** : You can delete the template.



Delivery reports [Menu 1-8]

You can read and delete delivery report messages.

Settings [Menu 1-9]

Message types

Text, Voice, Fax, Natl. paging, X.400, E-mail, ERMES

Usually, the type of message is set to **Text**. You can convert your text into alternative formats, which are suitable for the device that will be received the message. Contact your service provider for the availability of this function.

Validity period

This network service allows you to set how long your text messages will be stored at the message center while attempts are made to deliver them to you.

Delivery report

If you set **Yes** in this menu, you can check whether your message is sent successfully or not.



Pay for reply?

When a message is sent, it allows the person to whom you sent the message to reply and charges the cost of the reply to your telephone bill.

SMS centre

If you want to send the text message, you can get the address of SMS centre through this menu.

Paper

You can choose one of papers you want while writing messages.

Memory status [Menu 1-0]

If you select this menu, the phone shows an used memory and total amount of memory. The total memory is the sum of SIM and Phone memory.



Missed calls [Menu 2-1]

This menu shows recently missed numbers. You can call by this number, also save and view date and time this menu as well as writing messages.

Received calls [Menu 2-2]

This menu shows recently received numbers. You can call by this number, also save and view date and time, as well as writing messages.

Dialled calls [Menu 2-3]

This menu shows recently dialed numbers. You can call by this number, also save and view date and time, as well as writing messages.

All calls list [Menu 2-4]

You can save the phone number and check the date and time for a call. Moreover, you can call back to the other party, as well as writing messages.

Delete recent calls [Menu 2-5]

You can delete the all call records.



Call charge [Menu 2-6]

Within these submenus, you can view the duration and the call cost of your calls.

Call duration

This function allows you to view the duration of your Last Call, All Calls, Received calls and Dialed calls in hours, minutes and seconds. You can also reset the call timers.

1. Press [Menu] in standby mode.
2. Press for direct access or use and to enter **Call register**.
3. Scroll to highlight **Call charge** then **Call duration** and press [Select].

Show call costs

This function allows you to check the cost of your last call, all calls, remaining and reset the costs. To reset the cost, you need the PIN2 code.

1. Press [Menu] in standby mode.
2. Press for direct access or use and to enter **Call register**.
3. Scroll to highlight **Call charge** then **Show call costs** and press [Select] to enter.
The following 4 submenus : **Last call, All calls, Remaining cost** and **Reset all**.



Note

- The actual call cost may be different depending on network features, billing, and tax.

Settings [SIM Dependent]

• Set tariff

You can set the currency type and the unit price. Contact your services providers to obtain charging unit prices. To select the currency or unit in this menu, you need the PIN2 code.

1. Press [Menu] in standby mode.
2. Press **2abc** for direct access or Use **↑** and **↓** to enter **Call register**.
3. Scroll to highlight **Settings** and Press [Select] to enter.
4. Select **Set tariff**.

• Set credit

This network service allows you to limit the costs of your calls by selected charging units. If you select **Read**, the number of remaining unit is shown. If you select **Change**, you can change your charge limit.

1. Press [Menu] in a standby mode.
2. Press **2abc** for direct access or use **↑** and **↓** to enter **Call register**.
3. Scroll to highlight **Settings** and press [Select] to enter.
4. Select **Set credit**.





Note

- When all units have been used, no calls can be made except emergency calls. Depending on SIM card, you need the PIN2 code to set a call cost limit.

• Auto display

This network service allows you to see automatically cost of your last call. If you select **Yes** in **Auto display** menu, you can see the last cost when the call is released.

1. Press [Menu] in standby mode.
2. Press  for direct access or use  and  to enter **Call register**.
3. Scroll to highlight **Settings** and press [Select] to enter.
4. Select **Auto display**.



GPRS information [Menu 2-7]

You can check the amount of data transferred over the network through GPRS. In addition, you can also view how much time you are online.

Call duration

You can check the duration of GPRS call. You can also reset the call timers.

- **Last call**
- **All calls**
- **Reset**

Data volume

You can check the data volume.

- **Sent**
- **Received**
- **All**
- **Reset all**



In this menu, you can adjust and customize the phone tones for different events, environments and caller's group.

● Note

- When your phone is connected to the Handsfree kit, it'll be automatically set to the Car profiles menu and when your phone is connected to the Earmic, it'll be automatically set to Headset profiles menu then each submenu related to them will be displayed automatically.

Vibrate only [Menu 3-1]

- **Activate** : You can adjust the profile as Vibration if you need vibration mode.

Quiet [Menu 3-2]

- **Activate** : You can adjust the profile as Quiet if you are in quiet place.
- **Personalise**: You can change the values of Profile submenus.



General [Menu 3-3]

- **Activate** : You can adjust the profile as General.
- **Personalise**: You can change the values of Profile submenus.

Loud [Menu 3-4]

- **Activate** : You can adjust the profile as Loud if you are in a noisy environment.
- **Personalise**: You can change the values of Profile submenus.

Headset [Menu 3-5]

- **Activate** : You can adjust the Profiles as Headset when you put on a headset.
- **Personalise**: You can change the values of Profile submenus.



Car [Menu 3-6]

- **Activate** : You can adjust the Profiles as Car when you activate Handsfree Kit.
- **Personalise**: You can change the values of Profile submenus.

A Group of Profiles submenus [Menu 3-x-x]

Profiles menu have the submenus as shown below.

Incoming alert type

Allows to alert for the incoming call for adjusting environment.

Ring tone

Allows to set the ringing tone for adjusting environment.

Ring volume

Allows to set the ring volume for adjusting environment.

Message alert type

Allows to alert when receiving a message for adjusting environment: Ring once, Vibrate, Silent.

Keypad volume

Allows to set the keypad volume for adjusting environment.



Auto answer

Allows to set to answer automatically for adjusting environment. Please note that only Car and Headset has this sub menu so that you can activate this function.

- **Off**

Even though your phone is ringing, your phone will not answer automatically.

- **After 5 secs**

After 5 seconds your phone will answer automatically.

- **After 10 secs**

After 10 seconds your phone will answer automatically.

● Note

- If you set the Handsfree kit to the phone, you can't activate the vibration related with Incoming alert or Message alert menu. Therefore, in Handsfree menu, you can view the following submenus;
 - **Incoming alert** : Ring, Silent
 - **Message alert** : Ring Once, Silent



You can set the following menus for your convenience and preferences.

Alarm clock [Menu 4-1]

You can set the phone to alarm at a specified within this menu.

On

You can set the time (Hour and Minute) for raising the alarm.

1. Enter the menu.
2. Select **On** by pressing [Select], and then enter the alarm time you want.
3. Press [OK].
4. Select the repeat period: **Once, Daily, Weekly, and Monthly.**
5. If you set **Yes** in **Power off alarm**, the alarm signal sounds at the time you set even if the phone is turned off.

Off

You can cancel setting the alarm time.

1. Enter the menu.
2. Select **Off** by pressing [Select].
3. **Clear alarm** message is displayed.
4. If you want to cancel, press [Yes]. If not, press [No].



Date & time [Menu 4-2]

Date

- **Set date**

In this menu, you can set the date of your phone.

1. Enter the menu.
2. Select **Set date** by pressing [Select].
3. Enter the number you want to set the date.
4. Press [OK].

- **Date format**

You can set the **Date format** in this menu.



Time

The phone has its own clock. In this menu you can set the time and select between the 12-hour or 24-hour time formats.

1. Enter the menu.
2. Scroll to highlight **Time** by pressing [Select].

- **Set time:**

You can set time of your phone in this menu.

1. Select Set time by pressing [Select].
2. Enter the number you want to set the time.
3. Select the **AM/PM** you want to set the time format by long pressing  ,  key.
4. Press [OK].



- **Time format:**

Your can select time format between 12-hour or 24-hour.

1. Scroll to highlight Time format by pressing [Select].
2. Select 12 hour or 24 hour you want by pressing [Select].

Phone settings [Menu 4-3]

You can set the phone figures you want. Scroll to highlight **Phone settings** menu, and then press [Select].

Display settings

- **Screen saver**

If you don't activate any function for 20 seconds, the picture will be displayed in a standby mode.

- **Call**

You can set the animation as making a call.

- **Wallpaper**

You can select background picture in a standby mode.

- **Welcome note**

You can set the displayed message as turning on a phone.

- **Greeting note**

If you select yes, this menu allows you select the standby display. In text mode, you can edit the text.



- **Network name**

If you select On, you can set network name displayed on the phone as you want.

- **Backlight**

You can set the light-up duration you want whenever you press a key.

- **LCD contrast**



You can set the brightness of LCD you want by pressing  ,  .

Serial port

- **FAX**

You can set the rate of serial port to 19200bps for using the application between PC and fax.

- **GPRS & Data**

You can set the rate of serial port to 115200bps for using PC application for GPRS call and Data call.

Languages

You can select the language will be displayed.



Call settings [Menu 4-4]

You can set the menu relevant to a call by pressing [Select] in Setting menu.

Anykey answer

- **On**

If you select this menu, you can receive a call by pressing any key except  key.

- **Off**

If you select this menu, you can receive an incoming call by only pressing  key.

● **Note**

- **How to use Handfree portable:**

If you want to use the handsfree portable(earphone), please press the button  for a long time after inserting it to the connector when incoming a call.

Send my number

(network and subscription dependent)

- **On**

If you select this, you can send your phone number to the other party. That is, your phone number will be displayed on receiver's phone.

- **Off**

If you select this, you can't send your phone number.



Call waiting

(network dependent)

If this service is Enable, you can accept a waiting (incoming) call.

- **On**

Activating the corresponding service.

- **Off**

Deactivating the corresponding service.

- **View status**

Checking the Status of the service.

Minute minder

If you select **On**, you can check the call duration by beep sound every minute during a call.

Auto redial

- **On**

When this function is set on, your phone will make up to 10 attempts for a call after not connecting.

- **Off**

Your phone will not make any attempts to connect the call after not connecting.



Select line



This function is only used if **Alternate line service** supported by the Service Provider. Two independent phone numbers are registered for the phone. This function provides you with the selection the currently used phone number. If this function is supported by your service provider, the following menu will be displayed.

- **Line 1** : Select Line 1 as the current phone number.
- **Line 2** : Select Line 2 as the current phone number.

Security settings [Menu 4-5]

PIN code request

In this menu, you can set the phone to ask for the PIN code of your SIM card when the phone is switched on. If this function is activated, you'll be requested to enter the PIN code.

1. Press [Menu] in standby mode.
2. Press  key for direct access or use  and  to enter **Settings**.
3. Scroll to highlight **Security settings** menu.
4. Select **PIN code request** by pressing [Select].
5. You can view the following submenus.
 - **On** : Enable PIN code request.
 - **Off** : Disable PIN code request.



Phone lock

You can use security code to avoid unauthorized use of your phone. When you switch on your phone, your phone will request security code always if you set phone lock to “On”. If you set phone lock to “Automatic”, your phone will request security code only when you change your SIM card.



- On
- Off
- Automatic

Automatic key lock

When you enable Automatic key lock, keypad will be lock automatically on an idle screen after 25 seconds without any key requesting.

- On
- Off

Note

- If you want to lock your phone keypad manually, enter Top menu and press  key.
- If you want to unlock your phone keypad, press  [unlock] key and then press  key. But if you enabled Automatic key lock before, your phone keypad will be unlock and then after 25 seconds the keypad will be lock up again automatically.



Call barring

The Call barring service prevents your phone from making or receiving certain category of calls. This function requires the call barring password. You can view the following submenus.

- **All outgoing :**

The barring service of all outgoing calls.

- **International :**

The barring service of all outgoing international calls.

- **International except home :**

The barring service of all international outgoing calls except home network.

- **All incoming :**

The barring service of all incoming calls.

- **Incoming when abroad :**

The barring service of all incoming calls when abroad.

- **Cancel all :**

You can cancel all barring service.



- **Change passwd :**

You can change the password for Call Barring Service.





Fixed dial number (SIM dependent)

You can restrict your outgoing calls to selected phone number. The numbers are protected by your PIN2 code.

1. Press [Menu] in standby mode.
2. Press  key for direct access or use  and  to enter **Settings**.
3. Scroll to highlight **Security settings** menu.
4. Select **Fixed dial number** by pressing [Select].
5. If the PIN 2 code is correct, you can view the following submenus.
 - **Activate** : You can restrict your outgoing calls to selected phone number.
 - **Cancel** : You can call without restricting phone number.
 - **Number list** : You can view the number list saved as Fixed dial number.

Change codes

You can change the access codes : **PIN, PIN2, Security code**.

1. Press [Menu] in standby mode.
2. Press  for direct access or use  and  to enter **Settings**.
3. Scroll to highlight **Security settings** menu.
4. Select **Change codes** by pressing [Select].
5. If you want to change the PIN/PIN2/Security code, input your original code, and then press [OK].
6. Input new PIN/PIN2/Security code, and verify them.



Network settings [Menu 4-6]

You can select the network which you will be registered either automatically or manually. Usually, the selection of the network used by the handset is automatic.

Automatic

The phone automatically selects network which is available in the area.

Manual

The phone will find the list of available networks and show you them. Then you can select the network which you want to use if this network has a roaming agreement with your home network operator.

Preferred

You can set a list of preferred networks the handset should attempt to register with first, before attempting to register to any other networks. This list is created from the handset's predefined list of known networks.

User define

You can add entries or delete new ones from the network list. This can even include new networks whose network codes are not known to the handset. To do this, select and then enter the network code, country code and network name.

Reset setting [Menu 4-7]

You can set the handset to the default configuration by selecting this menu. In addition, you need Security code to activate this function.

Call Divert [Menu 5]



Accessing the Menu

(network and subscription dependent)

The Call divert service allows to divert incoming voice calls, fax calls, and data calls to another number. For details, contact your service provider.

All voice calls [Menu 5-1]

Diverts voice calls unconditionally.

If busy [Menu 5-2]

Diverts voice calls when the phone is in progress.

If no reply [Menu 5-3]

Diverts voice calls which you do not answer.

If out of reach [Menu 5-4]

Diverts voice calls when the phone is switched off or out of range.

All data calls [Menu 5-5]

Diverts to a number with a PC connection unconditionally.

Call Divert [Menu 5]



Accessing the Menu

(network and subscription dependent)

All fax calls [Menu 5-6]

Diverts to a number with a fax connection unconditionally.

The submenus [Menu 5-x-x]

Call Divert menus have the submenus as shown below.

Activate

Activating the corresponding service.

- **To other number**

Inputs the number for diverting.

- **To favorite number**

You can check 5 diverted numbers.

- **To voicemail**

Forwards to message center. This function doesn't include All data calls and All fax calls menus.

● Note

- You can select the number you want in **Favorite** menu.



(network and subscription dependent)

Cancel

Deactivating the corresponding service.

View status

Checking the Status of the corresponding service.

Cancel all [Menu 5-7]

Cancels all call divert service.



Scheduler [Menu 6-1]

On top of the screen there are sections for date and icons. Whenever you change the date, the calendar will be updated according to the date. And square cursor will be used to locate the certain day. If you see under bar on the calendar, it means that there is a schedule that day. This function helps to remind you of your schedule and memo. The phone will sound an alarm tone if you set this for the note.

For changing the day, month, and year.

	Yearly		If you press these keys shortly, you can set the alarm daily. In case of pressing for a long time, you can set it weekly.
	Monthly		

Add new

You can edit maximum 30 characters. You can take a note. You can choose the following types of note. You can make up to maximum 20 notes.

- **Schedule**

Input the subject, the schedule time, the repeat time, alarm time by pressing [Select].



- **Repeat**

- **Once** : no repeat.
- **Daily** : repeat schedule daily for 5 days.
- **Weekly** : repeat schedule weekly for 5 weeks.
- **Monthly** : repeat schedule monthly for 5 months.
- **Yearly** : repeat schedule yearly for 5 years.

- **Alarm time**



- **On time** : alarm on time you set already.
- **10 min before** : alarm before 10 minutes from the schedule you set already.
- **30 min before** : alarm before 30 minutes from the schedule you set already.
- **1 hour before** : alarm before 1 hour from the schedule you set already.
- **1 day before** : alarm before 1 day from the schedule you set already.

- **Memo**

1. Select **Add New** by pressing [Select].
2. Scroll to highlight **Memo**.
3. Press [Select].
4. Input the memo and then press [Select].



View day

Shows the note for the chosen day. Use  ,  to browse through the note lists. If you set alarm for the note, Alarm watch is displayed. Press [Options] to delete, edit the note you selected.

• Options



- Edit

You can edit the subject, time, the repeat time and alarm time by pressing [Select].

- Delete

You can delete the note.

View all

Shows the notes that are set for all days. Use  ,  to browse through the note lists. You can use the same menu as “View date” by pressing [Options].

Delete past

You can delete for the last schedule already is notified you.

Delete all

You can delete for the all note(s).



Phone book [Menu 6-2]

Search

(Calling from phonebook)

1. Open the phonebook first by pressing [Names] in a standby mode.
2. **Search** by Pressing [Select] to enter.
3. Depending on setting **Search by**, the below menu may not appear.
 - **Name**
 - **Number**
4. You can find an entry by name and number.
5. Select [Search].
6. You can check the names and numbers by pressing [List].
7. If you want to edit, delete, copy an entry, or to add the voice to one, select [Options]. The below menu will be displayed.
 - **Edit** : You can edit the name, number, E-mail, and fax by pressing [OK].
 - **Delete** : You can delete an entry.
 - **Write message** : You can write message.
 - **Copy** : You can copy an entry from SIM to phone or from phone to SIM.
 - **Call** : You can call thru the chosen entry.
 - **Voice** : You can add the voice to the entry or change the voice tag.



- **Main number** : You can select the one out of mobile, home, office that you often use. The main number will be displayed first, if you set this.

Add new

You can add phonebook entry by using this function.

Phone memory capacity is 200 entries. SIM card memory capacity depends on the service provider.

You can also save 20 characters of name in the Phone memory, and you can save characters in the SIM card. The number of character is SIM dependent feature.

1. Open the phonebook first by pressing [Names] in standby mode.
2. Scroll to highlight **Add new**, and press [Select] to enter.
3. Select the memory you want to save: **SIM** or **Phone**.

- **SIM** : You can add name and number for entry.
 - a. Write a name to add.
 - b. Press [OK], then you can input a number.
 - c. Press [OK].
 - d. If you want to add the voice, press [Yes].
- **Phone** : You can add name, mobile, home, office, fax no. and E-mail address.
 - a. You can select among mobile, home and office by pressing [select].
 - b. Write a name to add.
 - c. Enter the numbers following as mobile, home, office by pressing [Next] for next step [Clear] for cancel and  for saving or exit.
 - d. If you want to add the voice, press [Yes].



You should speak a word within 2 seconds, and the phone asks you to speak it again to ensure the accuracy of voice recognition. After voice recognition has finished, Voice is attached automatically.

● **Note**

- The voice can only be attached to main number which you set. For example, If you change main number voice will be automatically attached changed number.
- You can add voice tag to phone number in SIM card. The voice tag can be erased removing or changing SIM card. And voice tag attached to phone number in SIM card may be attached to another phone number when you changed SIM card. Why? The answer is that SIM card doesn't contain information about voice tag.





Speed dials

You can associate any of the keys 2 to 9 with a Name list entry. You can call directly by pressing this key for 2-3 seconds.

1. Open the phonebook first by pressing [Names] in a standby mode.
2. Scroll to **Speed dials**, then press [Select] to enter this menu.
3. Every Speed dials will be displayed.
4. If you want to add Speed dials, select <Empty>. Then, you can search the name in phonebook.
5. If you select allocated name by Speed dials, you can view following the submenus.
 - **Change** : You can change the allocation of Speed dials number.
 - **Cancel** : You can cancel the allocated Speed dials number.



Voice list

You can see all phone numbers which contain voice. You can also call directly by pressing [Send]. After selecting phone number by using  and  press [Options], you can see following the submenus.

- **Play** : You can play voice which is attached to phone number.
- **Change** : You can change voice which is attached to phone number.
- **Delete** : You can delete voice which is attached to phone number.
- **Call** : You can call by selecting this menu.

Caller groups

You can list up to 20 members per one group. There are 7 groups you can make lists to.

1. Press [Names] to enter into the phonebook in standby mode.
2. Scroll to **Caller groups** item then press [Select] to enter this menu.
3. Every Group list will be displayed.: **Family, Friend, Colleague, VIP, Group1, Group2** and **Others**.
4. Select Group name that you want to manage by pressing [Select].



5. Then submenus below will be displayed.

- **View member**

- You can view the number list in Caller groups.
- You can select the member you want by pressing [Options] then you can enable the submenu such as **Edit, Delete, Write message, Copy, Voice** and **Main number**.

- **Group ring tone**

You can set the ring tone depending on Group.

- **Group animation**

You can set the animation for each group.

- **Add member**

You can add the member in Caller groups.

1. Scroll to highlight **Add member**, and then press [Select] to enter.
2. The group member shouldn't be exceeded 20. Otherwise, the error message will be displayed.
3. Press [OK] to add member.

- **Delete member**

You can delete the member already saved in phonebook.

- **Rename**

You can change group name.



Copy all

You can copy/move entries from SIM card memory to Phone memory or from Phone memory to SIM card memory.

1. Open the phonebook first by pressing [Names] in standby mode.
2. Scroll to **Copy all**, then press [Select] to enter this menu.
3. Then submenus below will be displayed.
 - **SIM to Phone** : You can copy the entry from SIM Card to Phone memory.
 - **Phone to SIM** : You can copy the entry from Phone memory to SIM Card.

Delete all

You can delete all entries in **SIM**, **Phone**, and **Voice**. This function requires Security code.

1. Press [Names] to enter into the phonebook in standby mode.
2. Scroll to **Delete all**, then press [Select].
3. Then select a memory to erase: **SIM**, **Phone**, **Voice**.
4. And then you will be requested to enter Security code.
5. Press [OK] or, press [Back] to cancel.



Settings

You can set preferred memory which includes **Variable**, **SIM** or **Phone** and preferred search which includes **Variable**, **Name** and **Number**.



1. Open the phonebook first by pressing [Names] in a standby mode.
2. Scroll to **Settings**, then Press [Select] to enter.
3. Then submenus below will be displayed.
 - **Set memory**
 1. Scroll to highlight **Set memory**, then press [Select] to enter.
 2. The three submenus are displayed.
 - **Variable** : If you select Variable, the phone asks you where to store whenever you add entries in Phonebook.
 - **SIM** : If you select SIM, the phone stores entries to SIM directly without asking you where to store.
 - **Phone** : If you select Phone, the phone stores entries to Phone directly without asking you where to store.
 - **Search by**
 1. Scroll to highlight Search by, then press [Select] to enter.
 2. The three submenus are displayed.
 - **Variable** : If you select Variable, the phone asks you how to search the entries.
 - **Name** : If you select Name, the phone searches entries by name.
 - **Number** : If you select Number, the phone searches entries by number.



Information

Service dial number

Use this function to access a particular list of services provided by your network operator (if supported by the SIM card).

1. Open the phonebook first by pressing [Names] in a standby mode.
2. Scroll to **Service dial number**, then press [Select] to enter.
3. The names of the available services will be shown.
4. Use  and  to select a service. Press [Send].

Memory status

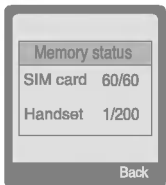

This feature allows you to see how many free and in-use are in your phonebook.

1. Open the phonebook first by pressing [Names] in standby mode. Select **Information** by pressing [Select].
2. Scroll to **Memory status**, then press [Select] to enter this menu.

Own number (SIM dependent)

You can check your own number in SIM card.



My folder [Menu 7-1]

All the contents downloaded through M-service or EMS such as images, ringtones and etc, are available in the My folder menu.

In this menu you can check the contents, edit their name and, eventually, set them as wallpapers or ringtones.

Downloaded polyphonic ringtones must be activated in this menu in order to make them available in the audio profiles ringtones list. You can activate just one downloaded ringtone at once.

Note

You can edit EMS sounds and images respectively in the Melody composer [Menu 7-3] and Graphic editor [Menu 7-4]. You can also attach this objects in an EMS message as described in the Write SMS chapter [Menu 1-1].











Game [Menu 7-2]

The phone offers you enjoyable games to play with.

● Note

The Control keys are different for each game. But each game has screens to explain the main control key (see key info.). Other common control keys are below.

[Common Key Function]









-  [Soft 1 Key] : Start game, and Ok key
-  [CLR] : Pause
-  [Soft 2 Key] : Back
-  [END] : Exit
-  : Stage and level control.
-  [Up,down key] : Volume control
-  [Star key] : Navigation to the left
-  [Sharp key] : Navigation to the right



Melody composer [Menu 7-3]

You can compose ringing sounds as you want.

When you enter this function, the tone that you created previously is displayed. To enter a new or edit an existing tone:

1. Enter the desired notes. ( ~  : CDEFGAB)
2. To adjust the characters of the note, do as follows:
 - **Duration** :  shortens and  lengthens the duration of the note or rest.
 - **Rest** :  inserts a rest of the same duration as the previous note.
 - **Octave** :  sets the octave for new notes.
 - **Sharp note** :  makes the note sharp.
 - **Clear** :  deletes each note.

e.g) 28# fi 8#d1

Graphic editor [Menu 7-4]

You can edit picture or graphic from an existing image file as you want.

1. To edit, choose the desired picture.
2. To adjust the picture, do as follows :
 - **Mode change** :
Toggle between play mode and move mode.
 - **Drawing and Erasing** :
Toggle between drawing and erasing.
3. For help, press  for a long time.



Note





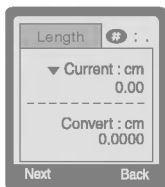

In edit mode, default is set in move mode and drawing.

With a , you can move fast between pixels.

Unit converter [Menu 7-5]









This converts any measurement into a unit you want. There are 4 types that can be converted into units: **Length, Area, Weight, and Volume.**

1. You can select one of four unit types by pressing [Next] key.
2. Select the unit you want to convert by pressing  and .
3. You can toggle between **Current** and **Convert** by long pressing  and .
4. You can input the prime number after the decimal place by pressing .
5. You can delete the number you want by pressing .
6. Press  key or [Back] key if you want to end the process for converting the value.







Calculator [Menu 7-6]

This contains the standard functions such as +, -, *, ÷ : **Add, Subtract, Multiply, Divide.**

1. Input the numbers by pressing numeric keys.
2. Press  key once for Add and long press for Multiply. Press  key once for Subtract and long press for divide.
3. Press  key to input Prime number and  key to input Negative number.
4. You can view the result by pressing [Result] key.
5. If you want to continue the calculation, repeat the process.
6. You can delete the number or sign you want by pressing  .
7. Press  key if you want to end the calculation process.

World time [Menu 7-7]

You can view the time for each city around the world.

when you press  ,  shortly, you can view the city belonged to the different time zone and when you press  ,  long, you can view the all of city on the same time zone.

If you want to select the country you want, press [set] key.





Your phone supports services based on Wireless Application Protocol (WAP). You can access services supported by your network. The services menu allows you to get the information such as news, weather reports, and flight times.

Home [Menu 8-1]

You can connect to the configured homepage of the activated profile.

Bookmarks [Menu 8-2]

When you enter this menu, you can see the bookmarks. Then press  button to access available option, or press  to exit it.

- **Connect** : Connect to selected bookmark.
- **Add new** : Add a new bookmark manually.
- **Edit** : Edit the title and the address of the selected bookmark.
- **Delete** : Delete the selected bookmark from the bookmark list.

Push messages [menu 8-3]

You can receive messages related with WAP which is included URL. So you can connect to indicated URL directly.

Inbox

You can read or delete the push messages.

Setting

You can set push the messages.



Profiles [Menu 8-4]

You can make up to 5 profiles and activate only one of them. Scroll to the desired profile and press  to access available options.

- **Activate**

You can activate the selected profile.

- **Settings**

You can edit and change WAP settings of the selected profile.

- **Homepage**

This setting allows you to enter the address (URL) of the site you want to use as homepage. You do not need to type “http://” in front of each URL as the WAP Browser will automatically add it.

- **Display image**

You can select whether images on WAP cards are displayed or not.

- **Conn. type**

The options for connection type are Continuous or Temporary and depend on the gateway.

- Temporary**

A non-confirmed (connectionless) service.

- Continuous**

A confirmed delivery mechanism but generates more network traffic.



- **Conn. security**

The options are **On** and **Off** depend on the gateway you are using.

- **Gateway information**

Most of WAP gateways do not require a User ID and Password. If your gateway need them to connect to it, then your network should provide them, and you must set them up correctly before trying to browse a WAP site.

- **Bearer**

Data

GPRS

- **Data settings**

These values of setting are provided by yours network.

IP address : Enter the IP address of the WAP gateway you are using to access.

Dial number : Enter the telephone number to dial to access your WAP gateway.

Call type : Select the type of data call.: Analogue or ISDN (Digital).

Call speed : The speed of your data connection.

User ID : The user identity for your dial-up server (and NOT the WAP gateway).

Password : The password required by your dial-up server (and NOT the WAP gateway) to identify you.



- GPRS settings

The service settings are only available when GPRS is chosen as a bearer service.

- Linger timer

You can input timeout periods between 30sec, and 300sec. if any data wasn't input or transferred, the service will be unavailable.

• Rename

Edit the Profile Name.

• E-mail server

Save the URL of the E-mail server that you frequently use.

- Connect

Connect to the E-mail server that you configured.

- Edit address

Edit the URL of the E-mail server.

Go to URL [Menu 8-5]

You can directly connect to the site that you want. You need to enter the specific URL that you want to directly connect.



Cache settings [Menu 8-6]

You can remove the contents of Cache memory and change the Cache check mode.

Clear cache

The contents of Cache memory will be removed.

Check cache

You can change the time for checking the Cache memory.

- **Always**

The cache is always checked whenever URL is loaded or navigated.

- **Start only**

The cache is only checked when the WAP is started.

- **Off**

The cache is never checked.

Security certifications [Menu 8-7]

A list of the available certificates is shown.

Reset profiles [Menu 8-8]

You can reset all the current settings of profiles to the factory default.

If you are on line, you can see the following menus.

Home

This is the same as [Menu 8-1].

Reload

This reloads the current page.

Bookmarks

This is the same as [Menu 8-2].

Save as bookmarks

Save the current URL as a bookmark. You can also edit the bookmark title.

Go to URL

Same as [Menu 8-5].

Go to e-mail server

Connect to the E-mail server that you configured.

Set as e-mail server

Save the current URL as an E-mail server.

Save image

Save the browsed image.

To be able to data or fax service, you need the communicate software such as a data or a fax program. Before using these functions, you need to connect your phone to a computer or make sure that your phone is in connection with a compatible device.

Sending Data or Fax Calls

1. Connect your computer to the phone.
2. After starting the communicate software, make a call and transmit a data or fax.
3. After the data or fax transmission, you can end the call by just ending of the communicate software, pressing [End].

Receiving Data or Fax Calls

If you have separate numbers for voice, data and fax calls, your phone recognizes the type of call.

Receiving Data or Fax Calls – Separate numbers (Multi-numbers)

To use a data or a fax service, the display shows which type of call you are receiving.

To receive a data or fax call.

1. Connect your computer to the phone.
2. After starting the communicate software, accept a call and receive a data or fax (if it is not answered automatically).
3. After the data or fax reception, you can end the call by just ending of the communicate software, pressing [End].

Receiving Data or Fax Calls—Single number

If you have a SIM card that does not support separate voice, data and fax numbers, the phone does not recognize the type of incoming call.

To use a data or a fax service, make sure that you want to receive a data or fax call mode. You first have to set the phone to one of these options in the call mode (Settings → Call Setting → Next Incoming) sub menu.

To receive a data or fax call.

1. Press [Menu] in standby mode.
2. Select the call type you want (Voice, Data or Fax) and press [Select].
3. Connect your computer to the phone.
4. After starting the communicate software, accept a call and receive a data or fax (if it is not answered automatically).
5. After the data or fax reception, you can end the call by just ending of the communicate software, pressing [End].

Once you have set your phone for a specific incoming call, it remains set until you change it.

● PC Sync

PC Sync is a program for data exchange PC & Phone by data cable. Therefore, if you want to use this function, you have to buy accessory kit. About more detail for using guide refers to PC Sync Help file on the PC Sync CD.

During a call, the following menus will be displayed, not in a standby mode.

1 During a call

1-1 Putting a Call on Hold

You can place a call on hold or retrieve by just pressing the [Send] key. When a call is made or answered, press the [Send] key to place it on hold. When a call is held, press the [Send] key to make it active.

1-2 Making a Second Call

You can get a dial number from phonebook to make a second call. Press [Names] key then select **Search**. To save the dial number into phonebook during call, press [Names] key then select **Add new**.

1-3 Swapping Between Two Calls

To switch between two calls, select the [Options] key, then select Swap or just press [Send] key.

You can make one of two calls focused by pressing up/down arrow key. If you want to end one of two calls, make the call you want to end focused, then press [End] key when the call you want to end is focused.

1-4 Answering an Incoming Call

To answer an incoming call, simply press the [Send] key.

The handset is also able to warn you of an incoming call while you are already in a call. A tone sounds in the earpiece, and the display will show that a second call is waiting.

If Call Waiting is on, you can put the first call on hold and answer the second, by pressing [Send] or by selecting the [Answer] key.

You can end the current call and answer the waiting call by selecting the [Menu] key, then **End & Answer**.

1-5 Rejecting an Incoming Call

You can reject an incoming call without answering by simply pressing the [End] key.

When in a call you can reject an incoming call (1st call) by pressing the [Menu] key and selecting **Multiparty/End and Answer** or by pressing [End] key.

1-6 Controlling the volume during a call

You can control the volume during a call by pressing [Options] key and selecting **Volume** followed by  or .

1-7 Muting the Microphone

You can mute the microphone during a call by pressing the [Options] key then selecting **Mute**. The handset can be unmuted by pressing the [Unmute].

When the handset is muted, the caller cannot hear you, but you can still hear them.

1-8 Switching DTMF Tones on During a Call

To turn DTMF tones on during a call, for example, to allow your handset to make use of an automated switchboard, select the [Options] key, then **DTMF On**. DTMF tones can be turned off the same way.

1-9 Calling up the messages or SIM Tool Kit

The Messages and SIM Tool kit main menu options can be reached from the in-call menu by selecting the [Options] key, then **Messages or SIM Tool Kit** (Screen name depends on the network operator's SIM). SIM Tool kit menu is shown only when SIM in the handset supports SIM Tool kit service.

2 Multiparty or Conference Calls

The multiparty or conference service provides you with the ability to have a simultaneous conversation with more than one caller, if your network service provider supports this feature.

A multiparty call can only be set up when you have one active call and one call on hold, both calls having been answered. Once a multiparty call is set up, calls may be added, disconnected or separated (that is, removed from the multiparty call but still connected to you) by the person who set up the multiparty call. These options are all available from the in-call menu and are listed in Section.

The maximum callers in a multiparty call is five. Once started, you are in control of the multiparty call, and only you can add calls to the multiparty call.

2-1 Making a Second Call

You can make a second call while you are already in a call. To do this, enter the second number and press [Send]. When you get second call the first call is automatically put on hold. You can swap between calls by selecting the [Options] key then **Swap**.

2-2 Setting up a Multiparty Call

You can connect a call on hold to the currently active call to form a multiparty call by selecting the [Options] key then **Multiparty/Join all**.

2-3 Putting the Multiparty Call on Hold

To put a multiparty call on hold, select the [Options] key then **Multiparty/Hold all**.



2-4 De-activate the Multiparty Call on Hold

To de-activate a multiparty call on hold, select the [Options] key then **Multiparty/Join all**.

2-5 Adding Calls to the Multiparty Call

To join an active call to the held multiparty call, select the [Options] key then **Multiparty/Join all**.

2-6 Displaying Callers in a Multiparty Call

To scroll through the numbers of the callers who make up a multiparty call on the handset screen, press  and  keys.

2-7 Putting a Member of a Multiparty Call on Hold

To place one selected caller (whose number is currently displayed on-screen) of a multiparty call on hold, select the [Options] key then **Multiparty/Exclude**.

2-8 A Private Call in a Multiparty Call

To have a private call with one caller of a multiparty call, display the number of the caller you wish to talk to on the screen, then select the [Options] key and **Multiparty/Private** to put all the other callers on hold.

2-9 Ending a Multiparty Call

The currently displayed caller of a multiparty call can be disconnected by pressing the [End] key. To end a multiparty call, press the [Options] key then select **Multiparty/End** multiparty.

Selecting the [Options] key then **Multiparty/End all**, will end all the active and held calls.

2-10 Explicit Call Transfer (ECT)

If you have one caller on hold and another active call, you may connect one call party to another call party and then leave the call. This is done by selecting the **Multiparty/Transfer** option from the in-call menu.

When using this unit, basic safety precautions as below should be always followed.

- Do not touch the adapter with wet hands.
- Do not disassemble this unit. (Take it to a qualified service technician when repair work is required.).
- Away from electrical appliance such as a TV, radio or personal computer.
- The unit should be situated from heat sources such as radiators or cookers.
- Do not drop.
- Do not subject this unit to mechanical vibration or shock.
- The coating of the phone may be damaged if covered with wrap or vinyl wrapper.
- Use dry cloth to clean the exterior of the unit. (Do not use solvent such as benzene, thinner or alcohol.)
- Do not subject this unit to excessive smoke or dust.
- Do not keep the phone next to credit cards or transport tickets; it can be affected the information on the magnetic strips.
- Do not tap the screen with a sharp object; otherwise, it may damage the phone.
- Do not expose the phone to liquid or moisture.
- Use the accessories like an earphone cautiously. Do not touch the antenna unnecessarily.

■ Caring for the Battery

- You do not need to completely discharge the battery before recharging. Unlike other battery systems, there is no memory effect that could compromise the battery's performance.
- Use only LG batteries and chargers. LG chargers are designed to maximize the battery life.
- Do not disassemble or short-circuit the battery pack.
- Keep the metal contacts of the battery pack clean.
- Replace the battery when it no longer provides acceptable performance. The battery pack may be recharged hundreds of times until it needs replacing.
- Recharge the battery if it has not been used for a long time to maximize usability.
- Do not expose the battery charger to direct sunlight or use it in high humidity, such as the bathroom.
- Do not leave the battery in hot or cold places, this may deteriorate the battery performance.

General

Product Name : G5300

System : GSM 900/DCS 1800

Ambient Temperatures

Max : +55°C

Min : -10°C

Declaration of Conformity



LG Electronics

This model complies with the essential requirements of Article 3 of the R&TTE 1999/5/EC Directive, if used for its intended use.

1. Health (Article 3.1.a of the R&TTE Directive)
2. Safety (Article 3.1.a of the R&TTE Directive)
3. Electromagnetic compatibility (Article 3.1.b of the R&TTE Directive)
4. Efficient use of the radio frequency spectrum (Article 3.2 of the R&TTE Directive)

I hereby declare under our sole responsibility that the product mentioned above to which this declaration relates complies with the above mentioned articles of the directive.

If available, write the contact person(s)

Mr. Jin Seog, Kim
LG Amsterdam Branch Office
Capronilaan 6, 1119 NR Schiphol-rijik,
The Netherlands
(Tel.) +31-20-655 7774

Mr. Ji Jong, Jeon
LG Electronics Inc. GSM Division
Emerald BD, 1042 Hgye-Dong, Dongan-Gu
Anyang-city, Kyuonki-Do
431-080, Korea

CE 0700