

시방회차: 1

날짜: 2003년 7월 1일

시방번호: 03MOC07986

P/No: 3828W5A3060

담당자: 김홍철

변경 내용: 모델명추가-앞표지, 2P, 4P, 5P, 9P, 13P, 14P, 20P

(이후 나머지 4개국에도 동일적용: 9P이후)



# Instruction Manual



MS-197H • MS-207H • MS-192A • MS-202A • MS-202T  
MS-202U • MS-202W • MS-202Y • MS-202YS • MS-1922G  
MS-2022E • MS-2323L • MB-382W • MB-392AA • MB-392W  
MB-3822G • MB-3922E • MB-402T • MB-4323L • MG-562W  
MG-562Y • MG-562YS • MH-602Y • MH-602YS • MH-6323L

# Oven Parts/Части на фурната/Componentele cuptorului/

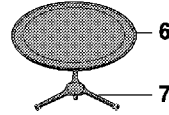
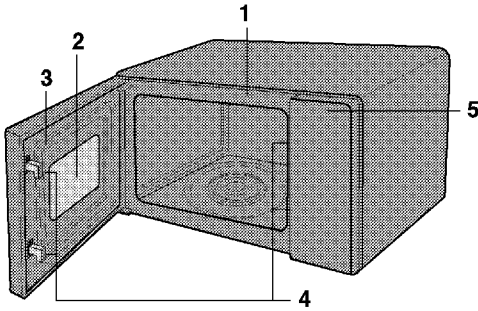

MB-382W  
 MB-392AA  
 MB-392W  
 MB-3822G  
 MB-3922E  
 MB-402T  
 MB-4323L  
 MG-562W  
 MG-562Y  
 MG-562YS  
 MH-602Y  
 MH-602YS  
 MH-6323L



MS-2323L  
 MB-4323L  
 MG-562W  
 MG-562Y  
 MG-562YS

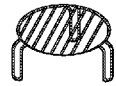

8

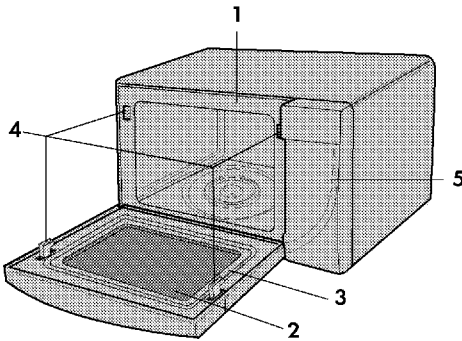

## Delovi pećnice/Dijelovi pećnice

- (GB)**
1. Front plate
  2. Viewing window
  3. Door seal
  4. Safety lock system
  5. Control panel
  6. Glass tray
  7. Roller rest
  8. Grill rack

- (BG)**
1. Преден панел
  2. Прозорец за наблюдение
  3. Уплътнител на вратата
  4. Предпазна заключваща система
  5. Командно табло
  6. Стъклена поставка
  7. Въртяща се подложка
  8. Скара за грил

- (RO)**
1. Panoul frontal
  2. Fereastra de vizualizare
  3. Dispozitiv etanșare ușă
  4. Sistem de blocare pentru siguranță
  5. Panou de control
  6. Tăviță de sticlă
  7. Suport rolă
  8. Grătar

- (CA)**
1. Prednji pladanj
  2. Prozorčić
  3. Hermetički zatvarač vrata
  4. Sigurnosni sistem zatvaranja
  5. Kontrolna ploča
  6. Stakleni pladanj
  7. Uporište valjka
  8. Rešetka za roštilj

- (SB)**
1. prednja ploča
  2. ekran za gledanje
  3. diht na vratima
  4. sigurnosni sistem
  5. kontrolni panel
  6. staklena tacna
  7. rotirajuće postolje
  8. rešetka za roštilj

# Control Panel/Командно табло/Panoul de control/

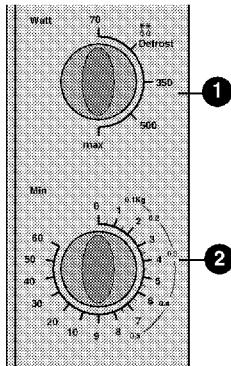

MS-197H/MS-207H

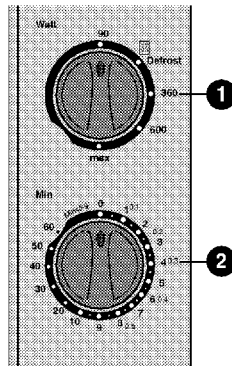

MS-192A/MS-202A

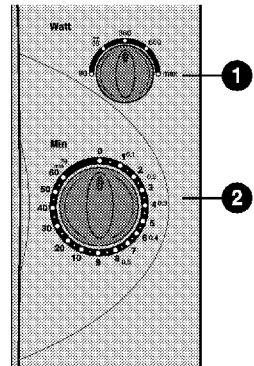

MS-202T

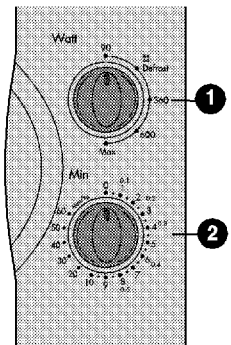

MS-202U

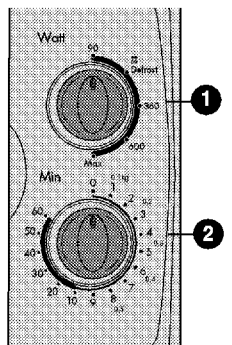

MS-202W

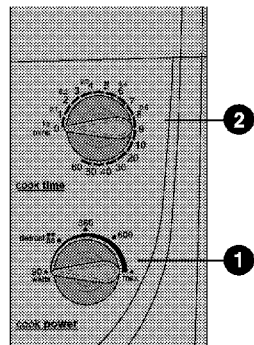

MS-202Y/MS-202YS

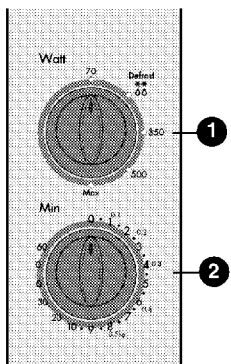

MS-1922G

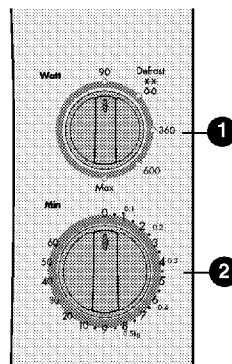

MS-2022E

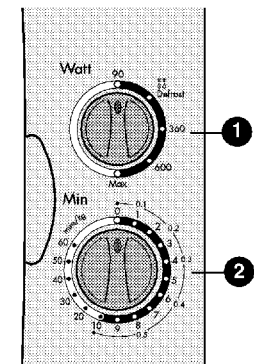

MS-2323L

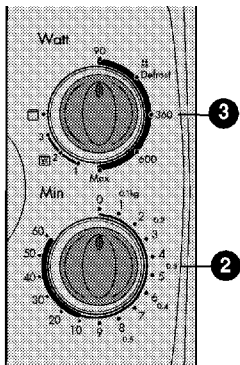

MB-382W/MB-392W

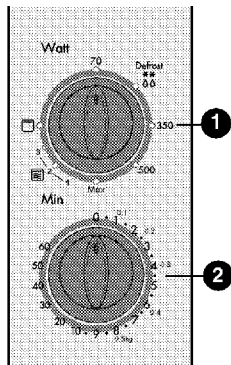

MB-3822G

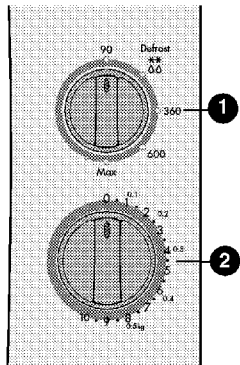

MB-3922E

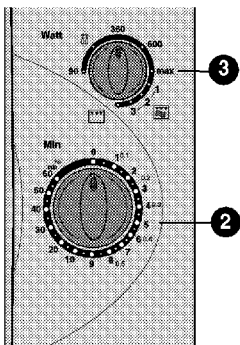

MB-402T

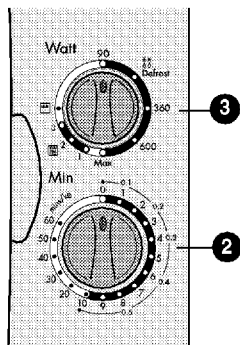

MB-4323L/MH-6323L

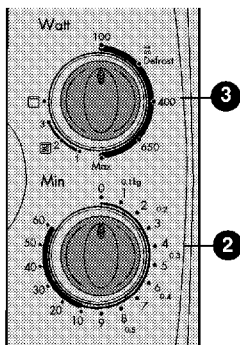

MG-562W

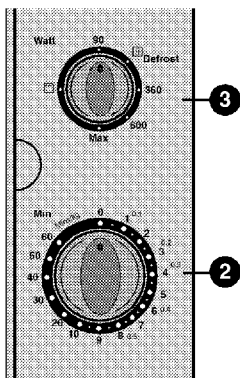

MB-392AA

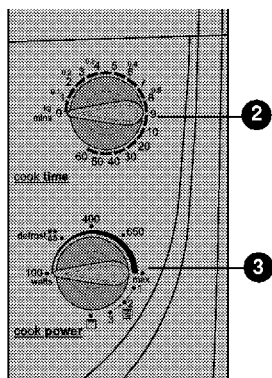

MG-562Y/MG-562YS

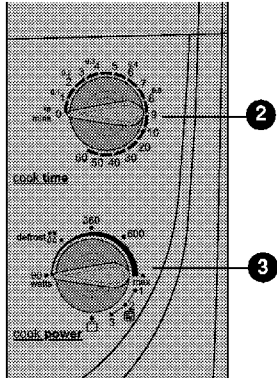

MH-602Y/MH-602YS

## Kontrolna ploča/Kontrolni panel



- 1 Power selector**  
Allows selection of desired power.
- 2 Timer**  
permits selection of the desired cooking time.
- 3 Function & Power selector**



- 1 Ключ за избор на мощност**  
Позволява избор на желана мощност
- 2 Таймер**  
Позволява избор на желано време на готвене.
- 3 Ключ за избор на режим и мощност**



- 1 Selector de putere**  
Permite selectarea puterii dorite.
- 2 Timer**  
Permite selectarea timpului de preparare dorit.
- 3 Selector funcție & putere**



- 1 Birač jačine**  
Omogućuje biranje željene jačine
- 2 Mjerač vremena**  
Omogućuje biranje željenog vremena kuhanja
- 3 Birač funkcija i jačine**



- 1 Selektor snage**  
Omogućava da odaberemo željenu snagu.
- 2 Sat**  
Omogućava da odaberemo željeno vreme kuvanja.
- 3 Selektor funkcija i snage**

**GB**

**P8**

**MICROWAVE OVEN OWNER'S MANUAL**

Please read this owner's manual thoroughly before operating.

**BG**

**P22**

**РЪКОВОДСТВО ЗА ПОТРЕБИТЕЛЯ НА МИКРОВЪЛНОВА ФУРНА**

Моля прочетете внимателно това ръководство преди работа.

**RO**

**P36**

**MANUAL DE UTILIZARE PENTRU CUPTOR CU MICROUND**

Citiți cu atenție acest manual de utilizare înainte de operare.

**CA**

**P50**

**PRIRUČNIK ZA MIKROVALNU PEĆNICU**

Molimo vas da pažljivo pročitate ovaj priručnik pre upotrebe.

**SB**

**P64**

**PRIRUČNIK ZA MIKROTALASNU PEĆNICU**

Molimo vas da pažljivo pročitate ovaj priručnik pre upotrebe.





## PRECAUTIONS TO AVOID POSSIBLE EXPOSURE TO EXCESSIVE MICROWAVE ENERGY

The oven cannot be operated with the door open due to the safety interlocks built in the door mechanism which switch off cooking functions when the door is opened. Operating the oven with the door open could result in harmful exposure to microwave energy. It is important not to tamper with the door mechanism.

Do not place any object between the oven front face and the door or allow soil or cleaner residue to accumulate on sealing surfaces.

Do not operate the oven if it is damaged. It is particularly important that the oven door closes properly and that there is no damage to the (1) door (bent), (2) hinges and latches (broken or loosened), (3) door seals and sealing surfaces.

The oven should not be adjusted or repaired by anyone except qualified service personnel.

GB

## WARNING

When heating liquids, e.g. soups, sauces and beverages in your microwave oven, delayed eruptive boiling can occur without evidence of bubbling. This could result in a sudden boil over of the hot liquid. To prevent this possibility the following steps should be taken:

1. Avoid using straight-sided containers with narrow necks.
2. Do not overheat.
3. Stir the liquid before placing the container in the oven and again halfway through the heating time.
4. After heating, allow to stand in the oven for a short time. Stir or shake the contents (especially feeding bottles and baby foods) and carefully check the temperature before use.

## Installation

1. Remove all packing materials and accessories.
2. Place the oven on a level surface a minimum of 85cm above the floor with at least 30cm above and 10cm rear space to allow adequate ventilation. The side of the oven should be kept clear so there is air flow for ventilation. The front of the oven should be at least 8cm from the edge of the surface to prevent tipping.

An exhaust outlet is located on top or side of the oven. Blocking the outlet can damage the oven.

3. Plug your oven into a standard voltage household outlet. Ensure that the electrical circuit is at least 10 amps (13 amps for models MB-392W • MB-382W • MB-3822G • MB-3922E • MB-402T • MB-4323L • MG-562W • MG-562Y • MG-562YS • MH-602Y • MH-602YS • MH-6323L) and that the oven is the only appliance on the circuit.

**NOTE:** • This appliance should not be used for commercial catering purposes.

## WARNING: THIS APPLIANCE MUST BE EARTHED

The wires in the mains lead are coloured in accordance with the following code:

Blue - Neutral  
Brown - Live  
Green and Yellow - Earth

If the power cord is damaged, it must be replaced by the manufacturer or its service agent or a similarly qualified person in order to avoid hazard.

## Precautions

- Do not operate the oven when empty. It is best to leave a glass of water in the oven when not in use. The water will safely absorb all microwave energy if the oven is accidentally started.
  - Do not dry clothes in the microwave oven. They may become carbonized or burned if heated too long.
  - Do not cook food wrapped in paper towels, unless your cook book contains instructions for the food you are cooking.
  - Do not use the oven for drying kitchen towels or paper products. They may burn.
  - Do not use wooden containers. They may heat up and char.
  - Do not use recycled paper products since they may contain impurities which may cause sparks and/or fires when used in cooking.
  - Allow the turntable to cool before cleaning.
  - Small amounts of food require shorter cooking or heating time. If normal times are allowed they may overheat and burn.
- Before cooking, pierce the skin of fruit and vegetables.
  - Do not cook eggs in their shell. Pressure will build up inside the egg which will burst.
  - Do not attempt deep fat frying in your oven.
  - Remove the plastic wrapping from food before cooking or defrosting. Note though that in some cases food should be covered with plastic film, for heating or cooking, as detailed in microwave cook books.
  - If smoke is observed, switch off or disconnect the oven from the power supply and keep the oven door closed in order to stifle any flames.
  - When food is heated or cooked in disposable containers of plastic, paper or other combustible materials, check the oven frequently due to the possibility of ignition.

- **WARNING** : Liquids or other foods must not be heated in sealed containers since they are liable to explode.
- **WARNING** : Only allow children to use the oven without supervision when adequate instructions have been given so that the child is able to use the oven in a safe way and understands the hazards of improper use.
- **WARNING** : If the oven door and door seal are damaged, the oven must not be operated until it has been repaired by a qualified service technician.
- **WARNING** : Do not attempt to tamper with, or make any adjustments or repairs to the door, control panel, safety interlock switches or any other part of the oven. It is hazardous for anyone to carry out any service or repair operation which involves the removal of any cover which gives protection against exposure to microwave energy. Repair should only be undertaken by a qualified service technician.

# Cooking Utensils

## COOKING UTENSILS

Utensils should be checked to ensure that they are suitable for use in the microwave oven. The following chart summarises the proper use of cooking utensils in your oven.

Cooking utensils	Microwave	Grill
Heat resistant glass, glass ceramic	yes	yes
Ceramic, china	yes (Do not use china with gold or silver trim.)	yes
Metal cookware	no	yes
Non-heat resistant glass	no	no
Microwave plastic	yes	no
Plastic wrap	yes	no
Paper (cup, plates, towels)	yes	no
Straw, wicker and wood	no	no

GB

### Microwave

- Most glass, glass ceramic, and heat resistant glassware utensils are excellent. Those with metal trim should not be used in a microwave oven.
- Paper napkins, towels, plates, cups, cartons, and cardboard can be used in the microwave oven. Do not use recycled paper products since they may contain impurities which may cause sparks and/or fires when used in cooking.  
(Consult your cookbook for correct use of these products.)
- Plastic dishes, cups, freezer bags, and plastic wraps may be used in the microwave oven. Follow the manufacturer's instructions or the information given in the cookbook when using plastics in the microwave oven.
- Metal utensils and utensils with metallic trim should not be used in the microwave oven. For more information on the proper use of metal in your oven, please read the introduction section in the cookbook. If the use of aluminum foil, skewers, or utensils containing metal in the oven is specified in the recipe, allow at least 2.5cm clearance between the metal object and the interior oven wall. If arcing (sparks) occurs, remove immediately.

### Note:

Consult your cookbook, individual recipes, and charts for correct use of cooking containers, products, and other useful information.

### Grill

- Heat resistant glassware, ceramic and metal cookware can be used.
- Paper napkins, towels, and plastics should not be used.

### Notes:

- Care should be taken when removing utensils or the glass turntable, as they may become hot during cooking.
- Only use a thermometer that is designed or recommended for use in the microwave oven.
- Ensure the turntable is in place when you operate the oven.

## Other Helpful Instructions

**For best results and more enjoyable cooking, please read these comments thoroughly.**

### For Best Results:

1. When determining the time for a particular food, begin by using minimum time and checking condition occasionally. It is easy to overcook food because microwaves cook very quickly.
2. Small quantities of food, or foods with low water content may dry out and become hard if cooked too long.

### Defrosting Frozen Foods:

1. Foods that have been frozen can be placed directly in the oven for thawing. (Be certain to remove any metallic ties or wraps.)
2. Defrost according to the Defrosting Tips found in this Manual.
3. For areas of the food thawing faster than others, cover with small pieces of aluminium foil. This helps slow down or stop the defrosting process.
4. Some foods should not be completely thawed before cooking. For example, fish cooks so quickly that it is sometimes better to begin cooking while still slightly frozen.

5. It may be necessary to increase or decrease the cooking time in some recipes, depending on the starting temperature of the foods.

### NOTE:

Air from the vent may become warm during cooking.

### Browning:

There are a few foods which are not cooked long enough in the microwave oven to brown and may need additional colour.

Coatings such as paprika, and browning agents such as Worcestershire sauce may be used on chops, meat patties or chicken pieces.

Roasts, poultry or ham, cooked for 10-15 minutes or longer, will brown without extra additives.

## Cleaning and Care

### BE SURE THE OVEN IS TURNED OFF BEFORE CLEANING.

Keep the oven interior surfaces clean and dry. As a general rule clean after each use.

### INTERIOR WALLS

Remove any crumbs and food remains between the door and oven using a damp cloth. This area has to be particularly well cleaned to ensure the door will close properly. Remove any grease splashes with a soapy cloth then rinse and dry. Do not use abrasives which may scratch and damage the painted surface of the oven.

NEVER POUR WATER INTO THE OVEN

### ROLLER REST

The roller rest should be removed and cleaned in hot soapy water at least once a week to prevent grease restricting the rotation of the wheels.

### DOOR

The door and door seals should be kept clean at all times. Use only warm, soapy water to rinse then dry thoroughly.

**DO NOT USE ABRASIVE MATERIALS, SUCH AS CLEANING POWDERS OR STEEL AND PLASTIC PADS.**

Metal parts will be easier to maintain if wiped frequently with a damp cloth.

### EXTERIOR

Clean with mild soap and warm water, rinse and dry with a soft cloth. Do not use abrasive materials. Do not spill water in the vents. If the power lead becomes soiled wipe it with a damp cloth.

# Operating Procedure

## MICROWAVE COOKING

### See page 3.

1. Open the oven door, place the food on the turntable in the oven, and close the oven door.
2. Set the power selector (1, 3) to the desired power level. There are five power levels from 70/90/100 Watts to max. The power selector can be set to any one of these positions.

MG-562W • MG-562Y MG-562YS (Watt)	MS-197H • MS-207H MS-1922G • MB-3822G (Watt)
<ul style="list-style-type: none"> <li>• max</li> <li>• 650</li> <li>• 400</li> <li>• ☼☼ defrost</li> <li>• 100</li> </ul>	<ul style="list-style-type: none"> <li>• max</li> <li>• 500</li> <li>• 350</li> <li>• ☼☼ defrost</li> <li>• 70</li> </ul>

MS-202A • MS-202T • MS-202U • MS-202W • MS-202Y MS-192A • MS-202YS • MS-2022E • MS-2323L • MB-392W MB-3922E • MB-402T • MB-4323L • MH-602Y MH-602YS • MH-6323L • MB-382W • MB-392AA (Watt)
<ul style="list-style-type: none"> <li>• max</li> <li>• 600</li> <li>• 360</li> <li>• ☼☼ defrost</li> <li>• 90</li> </ul>

3. Set the timer (2) to the desired cooking time. The turntable begins to rotate and cooking starts. At the end of cooking time the bell will ring, and the lamp is turned off.

### Note:

- Each number on the scale represents one minute. To ensure accurate timing, it is advisable to turn the timer knob slightly past the desired cooking time and then back to the proposed setting.
- Press the door opener to check the cooking condition during oven operation. Opening the door during cooking automatically turns off the oven and stops the timer. If cooking is to continue, close the door - the oven will turn on and the timer will resume counting.
- The turntable may rotate in either direction.

## WEIGHT DEFROST COOKING

### See page 3.

Defrosting frozen food is one of the benefits of a microwave oven. Defrosting using a microwave oven is much faster than in the refrigerator and safer than at room temperature, as it does not promote the growth of harmful bacteria.

It is important to remember that defrosting takes longer than normal cooking. Check the food, turning it over at least once during defrosting.

1. Turn the power select knob (1, 3) to set the defrosting mode. (☼☼)
2. Turn the timer knob (2) clockwise to set the weight (kg) of food.

**NOTE:** The oven starts working as soon as the timer knob is turned. Each number on the scale represents one **kg**.

GB

# Operating Procedure

MB-392W/MB-382W/MB-392AA/MB-3822G/  
MB-3922E/MB-402T/MB-4323L/MG-562W/MG-562Y/  
MG-562YS/MH-602Y/MH-602YS/MH-6323L

MB-392W/MB-382W/MB-3822G/MB-3922E/  
MB-402T/MB-4323L/MG-562W/MG-562Y/  
MG-562YS/MH-602Y/MH-602YS/MH-6323L

## GRILL COOKING

See page 3.

1. Open the oven door, place the food on the rack in the oven, and close the oven door.
2. For models MB-392W • MB-382W • MB-392AA • MB-3822G • MB-3922E • MB-402T • MB-4323L • MG-562W • MG-562Y • MG-562YS • MH-602Y • MH-602YS • MH-6323L turn the function & power selector (3) to grill mode (☐/☐☐).
3. Set the timer (2) to the desired cooking time. The turntable begins to rotate, cooking starts, and the lamp is turned on. At the end of the cooking time you will hear the bell ring and the lamp is turned off.

- Refer to the note under MICROWAVE COOKING if you want to check the cooking condition.
- Don't touch the viewing window during grill operation, because the temperature of the glass may rise up to 100°C.
- Prevent children from touching the front screen!
- When the grill is operated for the first time after purchasing the oven, some smoke may be observed. This will soon disappear.

### Note:

- Use of the grill rack is preferable, as time and performance of cooking will vary when turntable is used alone.
- This model is fitted with a GRILL, so preheating is not necessary.

## COMBINATION COOKING



See page 3.

The above models have a combination cooking mode which allows you to cook food with **grill** (☐/☐☐) and **microwave** (☐☐) at the same time. The time it takes to cook food using this mode is generally shorter than using the two features separately.

1. Open the oven door, place the food on the turntable or rack in the oven and close the oven door.
2. Turn the function selector (3) to COMBI mode (☐☐ + ☐/☐☐) (☐☐/☐☐) and power selector (4) to the desired power level.
3. Set the timer (2) to the desired cooking time. The turntable begins to rotate and cooking starts. At the end of cooking time you will hear the bell ring, and the lamp is turned off.

The **heater** grills the surface of the food while **microwave** cooking reaches inside.

**CAUTION:** After use, be sure to return the **TIMER** to 0 or the oven will continue to operate.

Be careful when removing your food the container will be hot!

## Heating or Reheating Guide

To heat or reheat successfully in the microwave, it is important to follow several guidelines. Measure the amount of food in order to determine the time needed to reheat. Arrange the food in a circular pattern for best results. Room temperature food will heat faster than refrigerated food. Canned foods should be taken out of the can and placed in a microwavable container. The food will be heated more evenly if covered with a microwavable lid or vented plastic wrap. Remove cover carefully to prevent steam burns. Use the following chart as a guide for reheating cooked food.

Item	Cook time (at HIGH)	Special Instructions
Sliced meat 3 slices (0.5cm thick)	1½~2½ minutes	Place sliced meat on microwavable plate. Cover with plastic wrap and vent. • Note: Gravy or sauce helps to keep meat juicy.
Chicken pieces 1 breast 1 leg and thigh	2~3½ minutes 1½~2½ minutes	Place chicken pieces on microwavable plate. Cover with plastic wrap and vent.
Fish fillet (170-230g)	1~2½ minutes	Place fish on microwavable plate. Cover with plastic wrap and vent.
Lasagne 1 serving (300g)	4½~7 minutes	Place lasagne on microwavable plate. Cover with plastic wrap and vent.
Casserole 1 cup 4 cups	1½~3½ minutes 5~7½ minutes	COOK covered in microwavable casserole dish. Stir once halfway through cooking.
Casserole cream or cheese 1 cup 4 cups	1½~3 minutes 4~6½ minutes	COOK covered in microwavable casserole dish. Stir once halfway through cooking.
Sloppy Joe or Barbecued beef 1 sandwich (½ cup meat filling) without bun	1~3 minutes	Reheat filling and bun separately. Cook filling covered in microwavable casserole dish. Stir once. Heat bun as directed in chart below.
Mashed potatoes 1 cup 4 cups	2~3½ minutes 6~8½ minutes	COOK covered in microwavable casserole dish. Stir once halfway through cooking.
Baked beans 1 cup	2~3½ minutes	COOK covered in microwavable casserole dish. Stir once halfway through cooking.
Ravioli or pasta in sauce 1 cup 4 cups	3~4½ minutes 8~11½ minutes	COOK covered in microwavable casserole dish. Stir once halfway through cooking.
Rice 1 cup 4 cups	1½~2 minutes 4~6 minutes	COOK covered in microwavable casserole dish. Stir once halfway through cooking.
Sandwich roll or bun 1 roll	20~35 seconds	Wrap in paper towel and place on glass tray.
Vegetables 1 cup 4 cups	1½~3 minutes 4~6 minutes	COOK covered in microwavable casserole dish. Stir once halfway through cooking.
Soup 1 serving (8 oz.)	2~3 minutes	COOK covered in microwavable casserole dish. Stir once halfway through cooking.



# Fresh Vegetable Chart

Vegetable	Amount	Cook time (at HIGH)	Instructions	Standing Time
Artichokes (230g each)	2 medium 4 medium	5~8 11~13	Trim. Add 2 tsp water and 2 tsp juice. Cover.	2-3 minutes
Asparagus, Fresh, Spears	450g	3~7	Add ½ cup water. Cover.	2-3 minutes
Green Beans	450g	8~12	Add ½ cup water in 1.5 litre casserole dish. Stir halfway through cooking.	2-3 minutes
Beets, Fresh	450g	13~18	Add ½ cup water in 1.5 litre covered casserole dish. Rearrange halfway through cooking.	2-3 minutes
Broccoli, Fresh, Spears	450g	5~9	Place broccoli in baking dish. Add ½ cup water.	2-3 minutes
Cabbage, Fresh, Chopped	450g	6~8	Add ½ cup water in 1.5 litre covered casserole dish. Stir halfway through cooking.	2-3 minutes
Carrots, Fresh, Sliced	200g	3~6	Add ½ cup water in 1 litre covered casserole dish. Stir halfway through cooking.	2-3 minutes
Cauliflower, Fresh, Whole	450g	8~10	Trim. Add ½ cup water in 1 litre covered casserole dish. Stir halfway through cooking.	2-3 minutes
Fresh, Flowerettes	2 cups	3~6	Slice. Add ½ cup water in 1.5 litre covered casserole dish. Stir halfway through cooking.	2-3 minutes
Celery, Fresh, Sliced	4 cups	8~10		
Corn, Fresh	2 ears	5~9	Husk. Add 2 tbsp water in 1.5 litre baking dish. Cover.	2-3 minutes
Mushrooms, Fresh, Sliced	230g	2~3	Place mushrooms in 1.5 litre covered casserole dish. Stir halfway through cooking.	2-3 minutes
Parsnips, Fresh, Sliced	450g	4~8	Add ½ cup water in 1.5 litre covered casserole dish. Stir halfway through cooking.	2-3 minutes
Peas, Green, Fresh	4 cups	7~10	Add ½ cup water in 1.5 litre covered casserole dish. Stir halfway through cooking.	2-3 minutes
Sweet Potatoes Whole Baking (170~230g each)	2 medium 4 medium	5~10 7~13	Pierce potatoes several times with fork. Place on 2 paper towels. Turn over halfway through cooking.	2-3 minutes 2-3 minutes
White potatoes, Whole Baking (170~230g each)	2 potatoes 4 potatoes	6~8 10~15	Pierce potatoes several times with fork. Place on 2 paper towels. Turn over halfway through cooking.	2-3 minutes 2-3 minutes
Spinach, Fresh, Leaf	450g	5~8	Add ½ cup water in 2 litre covered casserole dish.	2-3 minutes
Courgette, Fresh, Sliced	450g	5~8	Add ½ cup water in 1.5 litre covered casserole dish. Stir halfway through cooking.	2-3 minutes
Courgette, Fresh, Whole	450g	7~10	Pierce. Place on 2 paper towels. Turn courgette over and rearrange halfway through cooking.	2-3 minutes

## Defrosting Tips

### Defrosting meats tips & techniques

- You can defrost meats in their original wrapping as long as no metal is present. If necessary, shield small areas of meat or poultry with flat pieces of aluminium foil. This will prevent thin areas becoming warm during defrosting. Ensure the foil does not touch the oven walls.
- Food to be defrosted should be in a suitable microwave safe container and placed uncovered on the glass turntable.
- Defrost meats only as long as necessary. Separate items like minced meat, chops, sausages and bacon as soon as possible. Remove defrosted portions and continue to defrost remaining pieces. It is essential that food is checked during DEFROSTING as different foods vary in their defrosting speed.
- Whole pieces of meat are ready for standing time as soon as a fork can be pushed into the center of the meat using moderate pressure. The center will still be icy. Allow to stand until completely thawed.
- Defrost meat on defrost mode.

GB

Food	Weight	Defrosting time (minutes)	Standing time (minutes)	Remark
<b>BEEF</b>				
Frankfurter	450g	4-5	5-10	Turn over after half the time.
Minced beef	500g	7-9	5-10	Turn over after two thirds of the time, remove thawed portion.
Steak, sirloin	450g	5-7	5-10	Turn over after half the time. Separate.
Roast, loin(boneless)	1000g	10-15	10-15	Turn over after half the time. Shield as needed.
Patties	4ea (114g)	5-8	5-10	Turn over after half the time.
<b>PORK</b>				
Mince	500g	7-9	5-10	Turn over after two thirds of the time, remove thawed portion.
Chops	450g	5-6	5-10	Separate and turn over once.
Roast, loin(boneless)	1000g	10-15	10-15	Turn over after half the time. Shield as needed.
<b>POULTRY</b>				
Whole Chicken	1000g	17-23	10-15	Separate and rearrange once. Shield as needed.
Breasts (with bone)	450g	5-7	5-10	Separate and rearrange once.
Drumsticks	450g	8-9	5-10	Separate and rearrange once.
Thighs	450g	8-9	5-10	Separate and rearrange once.
Wings	450g	6-8	5-10	Separate and rearrange once.
<b>FISH &amp; SEAFOOD</b>				
Whole fish	450g	6-8	5-10	Turn over after half the time. Shield as needed.
Fish filelts	500g	7-9	5-10	Separate and rearrange once.
Shrimp	250g	4-6	5-10	Separate and rearrange once.

# Grill Cooking Chart

## Directions for grilling meat on grill

- Trim excess fat from meat. Cut fat, making sure you do not cut into the lean. (This will stop the fat curling.)
- Arrange on the rack. Brush with melted butter or oil.
- Halfway through, turn the meat over.

Item	Weight	Approx. Cooking time (in minutes)	Hints
Beefburgers	50g x 2 100g x 2	13-16 19-23	Baste with oil or melted butter. Thin items should be placed on the grill rack. Thick items can be placed on to a drip tray. Turn food over after half the cooking time.
Beefsteaks (2.5cm (1") thick)			
Rare	230g x 2	18-20	
Medium	230g x 2	22-24	
Well	230g x 2	26-28	
Pork chops (2.5cm (1") thick)	230g x 2	27-32	
Lamb chops (2.5cm (1") thick)	230g x 2	25-32	
Sausages	230g	13-16	Turn frequently.

## Directions for grilling fish and seafood

Place fish and seafood on the rack. Whole fish should be scored diagonally on both sides before grilling. Brush fish and seafood with melted butter, margarine or oil before and during cooking. This helps stop the fish drying out. Grill for times recommended in the chart. Whole fish and fish steaks should be carefully turned over halfway through grilling time. If desired thick fillets can also be turned halfway.

Item	Weight	Approx. Cooking time (in minutes)	Hints
Fish fillets			Brush with melted butter and turn over halfway through cooking.
1cm (½") thick	230g	17-21	
1.5cm (¾") thick	230g	20-24	
Fish steaks			
2.5cm (1") thick	230g	24-28	
Whole fish	225-350g each 450g	16-20 24-28	Allow extra time for thick and oily fish.
Scallops	450g	16-20	Baste well during cooking.
Prawns uncooked	450g	16-20	

## Questions and Answers

- Q. What's wrong when the oven light will not glow?
- A. ■ Light bulb has blown.  
■ Door is not closed.
- Q. Why is steam coming out of the air exhaust vent and/or why is water dripping from the bottom of the door?
- A. Steam is normally produced during cooking operations. The microwave has been made to vent this steam out of the side vent, occasionally this steam condenses on the door and water then drips out at the bottom of the door. This is quite normal and safe.
- Q. Does microwave energy pass through the viewing screen in the door?
- A. No. The metal screen reflects the energy to the oven cavity. The holes, or ports are made to allow light to pass; they do not let microwave energy through.
- Q. Will the microwave oven be damaged if it operates while empty?
- A. Yes. Never run it empty.
- Q. Why do eggs sometimes pop?
- A. When baking or poaching eggs, the yolk may pop due to steam build-up inside the yolk membrane. To prevent this, simply pierce the yolk with a toothpick before cooking. Never cook eggs without piercing their shells.
- Q. Why is standing time recommended after the cooking operation has been completed?
- A. Standing time is very important. With microwave cooking, the heat is in the food, not in the oven.

Many foods build up enough internal heat to allow the cooking process to continue, even after the food is removed from the oven. Standing time for joints of meat, large vegetables and cakes is to allow the inside to cook completely, without overcooking the outside.

- Q. Why does my oven not always cook as fast as the microwave cooking guide says?
- A. Check your cooking guide again, to make sure you've followed directions exactly; and to see what might cause variations in cooking time. Cooking guide times and heat settings are suggestions, to help prevent over-cooking . . . the most common problem in getting used to a microwave oven. Variations in the size, shape and weights and dimensions could require longer cooking time. Use your own judgement along with the cooking guide suggestions to check whether the food has been properly cooked just as you would do with a conventional cooker.
- Q. Why do sparks and crackling (arcing) occur in the oven?
- A. There may be several reasons why sparks and crackling (arcing) within cavity happens.
- You are using dishes with metal parts or trim (silver or gold).
  - You have left a fork or other metal utensil in the oven.
  - You are using a large amount of metal foil.
  - You are using a metal twist-tie.

# Technical Specifications

GB

	<b>MS-197H/MS-207H</b>	<b>MS-1922G</b>
Power Input	230 V AC, 50 Hz	230 V AC, 50 Hz
Output (IEC 60705 RATING STANDARD)	700 Watts	700 Watts
Microwave Frequency	2,450 MHz	2,450 MHz
Outside Dimensions (W x H x D mm)	483 x 285 x 355	455 x 285 x 313
Power Consumption	1,000 Watts	1,100 Watts

	<b>MS-202A/MS-202U/ MS-202T/MS-192A</b>	<b>MS-202W MS-2022E</b>
Power Input	230 V AC, 50 Hz	230 V AC, 50 Hz
Output (IEC 60705 RATING STANDARD)	800 Watts	800 Watts
Microwave Frequency	2,450 MHz	2,450 MHz
Outside Dimensions (W x H x D mm)	483 x 285 x 355	455 x 281 x 325
Power Consumption	1,200 Watts	1,200 Watts

	<b>MS-202Y/202YS</b>	<b>MS-2323L</b>
Power Input	230 V AC, 50 Hz	230 V AC, 50 Hz
Output (IEC 60705 RATING STANDARD)	800 Watts	800 Watts
Microwave Frequency	2,450 MHz	2,450 MHz
Outside Dimensions (W x H x D mm)	485 x 280 x 375	483 x 285 x 400
Power Consumption	1,200 Watts	1,200 Watts

	<b>MG-562W</b>	<b>MG-562Y/MG-562YS</b>
Power Input	230 V AC, 50 Hz	230 V AC, 50 Hz
Output (IEC 60705 RATING STANDARD)	900 Watts	800 Watts
Microwave Frequency	2,450 MHz	2,450 MHz
Outside Dimensions (W x H x D mm)	512 x 307 x 420	512 x 307 x 420
Power Consumption		
Microwave	1,300 Watts	1,300 Watts
Grill	1,250 Watts	1,250 Watts
Combination	2,500 Watts	2,500 Watts

	<b>MH-602Y/MH-602YS</b>	<b>MB-3922E</b>
Power Input	230 V AC, 50 Hz	230 V AC, 50 Hz
Output (IEC 60705 RATING STANDARD)	800 Watts	800 Watts
Microwave Frequency	2,450 MHz	2,450 MHz
Outside Dimensions (W x H x D mm)	485 x 280 x 375	455 x 281 x 325
Power Consumption		
Microwave	1,200 Watts	1,200 Watts
Grill	1,100 Watts	1,000 Watts
Combination	2,250 Watts	2,150 Watts

# Technical Specifications

GB

	<b>MB-392W/MB-382W</b>
Power Input	230 V AC, 50 Hz
Output (IEC 60705 RATING STANDARD)	800 Watts
Microwave Frequency	2,450 MHz
Outside Dimensions (W x H x D mm)	455 x 285 x 325
Power Consumption	
Microwave	1,200 Watts
Grill	1,100 Watts
Combination	2,250 Watts

	<b>MB-392AA</b>
Power Input	230 V AC, 50 Hz
Output (IEC 60705 RATING STANDARD)	800 Watts
Microwave Frequency	2,450 MHz
Outside Dimensions (W x H x D mm)	483 x 285 x 355
Power Consumption	
Microwave	1,200 Watts
Grill	1,100 Watts

	<b>MB-3822G</b>	<b>MB-402T</b>
Power Input	230 V AC, 50 Hz	230 V AC, 50 Hz
Output (IEC 60705 RATING STANDARD)	700 Watts	800 Watts
Microwave Frequency	2,450 MHz	2,450 MHz
Outside Dimensions (W x H x D mm)	455 x 281 x 313	483 x 285 x 355
Power Consumption		
Microwave	1,100 Watts	1,200 Watts
Grill	1,000 Watts	1,100 Watts
Combination	2,050 Watts	2,250 Watts

	<b>MB-4323L/MH-6323L</b>
Power Input	230 V AC, 50 Hz
Output (IEC 60705 RATING STANDARD)	800 Watts
Microwave Frequency	2,450 MHz
Outside Dimensions (W x H x D mm)	483 x 285 x 400
Power Consumption	
Microwave	1,200 Watts
Grill	1,000 Watts
Combination	2,150 Watts

- Dimensions shown are approximate.
- Because we continually strive to improve our products we may change specifications without prior notice.

