



Washing Machine

OWNER'S MANUAL

**MODEL : WP-1300QP/WP-1310QP
WP-1500Q(S)P/WP-1510Q(S)P**

Please read this manual carefully before operating your set.
Retain it for future reference.
Record model number and serial number of the set.
See the label attached on the back cover and quote this
information to your dealer when you require service.
This washing machine is designed and manufactured for
household use only.



CONTENTS

SAFETY MEASURE 3~4

PARTS IDENTIFICATION 4~5

INSTALLATION 6~7

PREPARATIONS BEFORE WASHING 8

HOW TO WASH 9

HOW TO RINSE 10~11

HOW TO SPIN 11

AFTER FINISHING 12

REFERENCE 12

CARE AND MAINTENANCE 13~14

TROUBLESHOOTING GUIDE 14

SPECIFICATIONS 15

- Manufacturer is not responsible for accidents caused by the user as a result of not following the user's guide.

! CAUTION

<p>In Operation</p> <ul style="list-style-type: none"> • Do not insert the hand inside the spin dryer basket while the machine is in operation. (Do not let children climb on the machine or climb into the tub injury may occur.) 	<p>Installation Area</p> <ul style="list-style-type: none"> • Avoid area exposed to snow, rain, or where humidity is high. It may cause electric shock.
<p>Switch Area</p> <ul style="list-style-type: none"> • Avoid watering on the switch area. It may cause electric shock or fire. 	<p>Spin Motor</p> <ul style="list-style-type: none"> • After continuous using spinning program 3 times, please stop spinning more than 1 hour. Otherwise the spin motor could be damaged or fired.
<p>Volatile Material</p> <ul style="list-style-type: none"> • Do not use volatile material such as Benzene, Gasoline, bug killer. Do not leave strong alkaline substance such as bleach inside the tub. Damage on plastic surface and rubber parts may occur. 	<p>Heat</p> <ul style="list-style-type: none"> • Avoid electric heater, candle light, cigarette light, bug smoker, etc. near the machine. It may ignite or deform plastic part.
<p>Electric Outlet</p> <ul style="list-style-type: none"> • Avoid connecting several electric devices to single outlet. It may cause fire. 	<p>Hard objects</p> <ul style="list-style-type: none"> • Remove pins, buckles and removable hard objects in the wash load to avoid damaging the tub before your washing
<p>Power Cord</p> <ul style="list-style-type: none"> • If the power supply cord is damaged, it must only be replaced by the manufacture or its service agent or a similarly qualified person in order to avoid a hazard. 	

! CAUTION

Hot water

- Avoid using hot water over 50°C. It may deform plastic parts or cause malfunction.



Installation

- Install the washing machine on a horizontal support. Otherwise, it may cause vibration and noise.

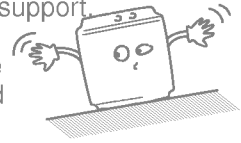

Power Cord

- Do not treat the power supply cord with your wet hand.

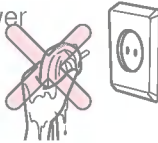

- Plug out the power supply cord, When cleaning or not using the washing machine for a long time.

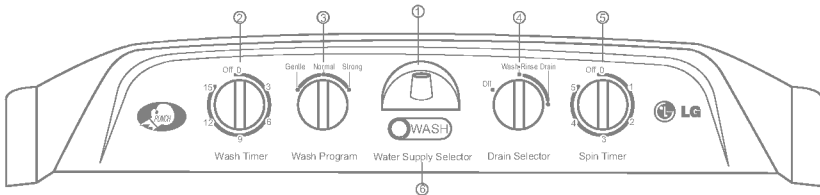
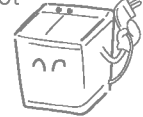

1. Water Supply Inlet

Connect here with the inlet hose from the water faucet to feed water to the tub.

2. Wash Timer

Select the desired time for washing or rinsing.

3. Wash Program

Set the selector to "GENTLE", "NORMAL", "STRONG" according to kinds and quantity of the laundry.

4. Drain Selector

Select "WASH-RINSE" for washing and rinsing and "DRAIN" to drain the water out of the tub, and "OFF" to turn off the drain pump.

5. Spin Timer

Select the desired time for spinning. The max. limit is 5 min. Don't rotate the knob more than prescribed limit.

6. Water Supply Selector



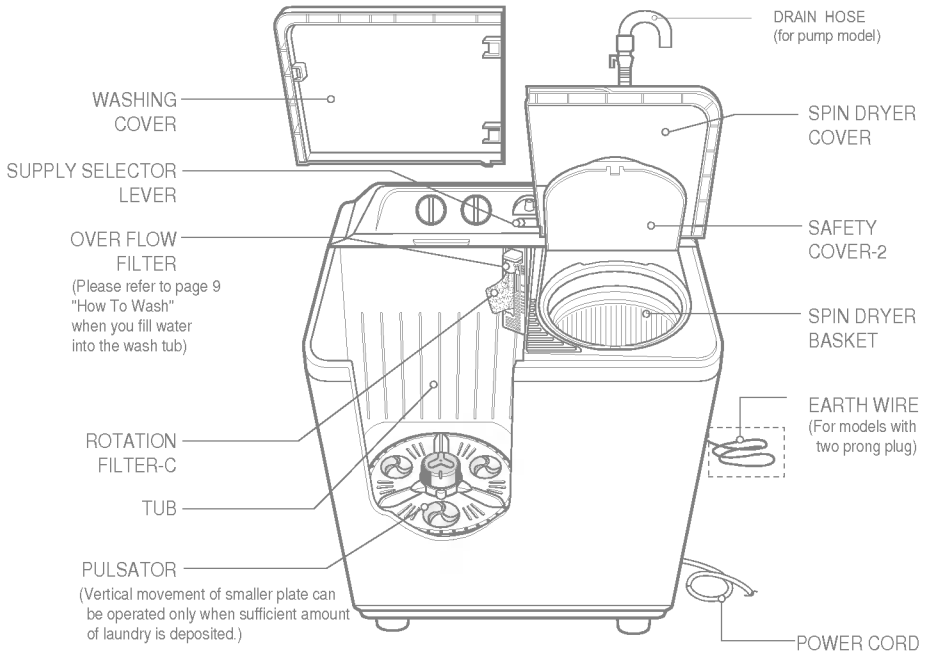

Select "WASH" to supply water for washing and rinsing and "SPIN" for spin shower rinse.

※ Buzzer(Option : Inside)

It is electrically operated to facilitate you to know the completion of washing cycle.

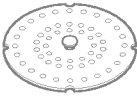

Accessories

<p>Safety Cover</p> 	<p>Drain Hose Asm</p> 	<p>Wheel Asm × 4</p>  <p>Wheel Shaft × 4</p> 	 <p>Adjustable Leg × 2</p>
---------------------------------------------------------------------------------------------------------	-----------------------------------------------------------------------------------------------------------	---------------------------------------------------------------------------------------------------------------------------------------------------------------------------------------------------------------------	---------------------------------------------------------------------------------------------------------------

Installation area

- Select flat and firm floor.
- Incorrect installation may cause severe noise and break down.
- Maintain more than 10cm between the side of drain hose and the wall.
- A carpet must not obstruct the ventilation openings.

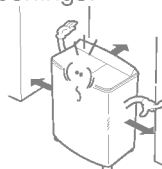

Leveling the machine (Option)

- Lift the front of the washing machine and twist the Adjustable Leg until the washing machine is placed evenly.
- If the Adjustable Leg is too short, use the Level Adjusting Plates as shown.

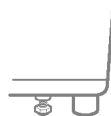

Connecting the drain hose

- Connect the drain hose to the outlet of the plunger valve located at the back side of the washing machine.
- Push the clamp toward the body of the washing machine as shown in the figure.

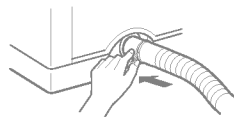
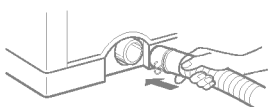

Voltage Change (only for dual voltage)

This washer is assembled for 220V, but can be changed from 220V to 110V(or 127V). Check your electrical source and follow the diagram below to convert voltage.

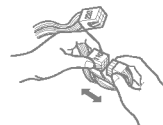
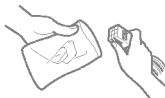
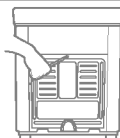

Connecting the earth wire

- Install the earth wire to prevent short-circuit due to leaking current and electric shock.
- It is attached at the back of the washer.
- Connect it to the metal water pipe. If the water pipe is made of plastic, it does not have the earth effect.
- Never connect the earth wire to the gas pipe, lightning arrester, telephone connector, etc.

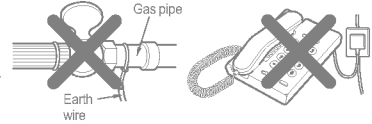

※ WARNING-THE APPLIANCE WITH TWO-PRONGED PLUG MUST BE GROUNDED.

Other earthing method

- After connect the earth wire to the earth copper plate, bury it at least 75cm deep under the wet ground.

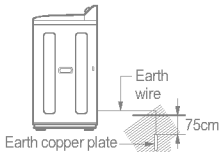

- Connect the earth wire to the earthing only outlet.

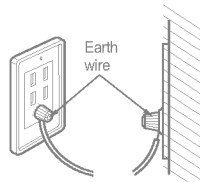

- When installing it in an area where earthing is not possible, purchase a short-circuit breaker (15mA at operation, 7.5mA at idle) and connect it to the outlet.

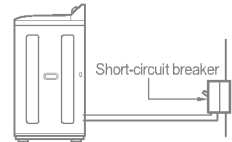

Connecting the power plug

- Insert the power plug into the outlet.
- Before connecting the power plug, check if the voltage setting of the washer matches the outlet voltage.
- If AC outlet with ground terminal is used, grounding is not needed. If not, never forget earthing (earthing method above).
- The appliance must be positioned so that the plug is accessible.

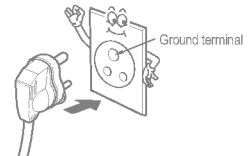

Preparation

- Connect the water supply hose to the water supply inlet.

- Set the supply selector lever to "WASH" for washing and rinsing, to "SPIN" for interim spin rinse.
 - Note: The water selector lever should not be placed near the center (as shown in Fig ④) otherwise water flows to the wash and spin tub simultaneously.)

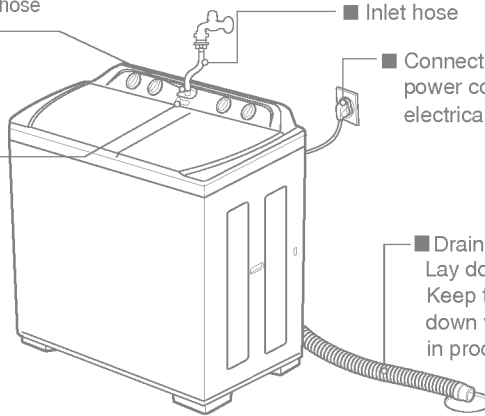

- Inlet hose

- Connect the power cord to the electrical outlet.

- Drain hose
Lay down the drain hose. Keep the drain hose flipped down while washing is in process

Before washing

- 1 Check the washing instructions labels on the clothing to be washing



- 2 Remove any objects from the pockets of the clothing. Object left in the pockets may damage the clothing or washing machine (especially cause clogging of the drain hose).

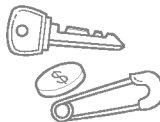

- 3 After separating an oiled or dyed laundry, wash.

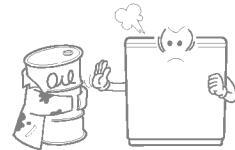

Note : For better wash of lots of laundry, Putting more heavily-soiled laundry first is recommended.

HOW TO WASH

1 Set the drain selector to "OFF" position.



2 Set the water selector to "WASH"



3 Open water supply and fill water till water level mark "H". That is because clothes can absorb adequate amount of water and water will not short.



4 Put the appropriate amount of detergent and the laundry into the wash tub. And add water to the desired water level which you want.



- Refer to TABLE 2 in REFERENCE on page 12.

5 Select the wash program to "GENTLE", "NORMAL", or "STRONG" according to the kinds and quantity of the laundry



- Refer to TABLE 2 in REFERENCE on page 12

6 Set the desired wash time.

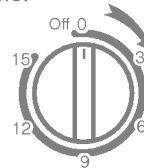

Wash Timer

- Refer to TABLE 2 in REFERENCE on page 12 for information on how to select the appropriate washing time.

7 When washing is finished, locate the drain selector to "DRAIN" position and drain the water out.



8 Spinning in the spin dryer basket.

- Move the laundry into the spin dryer basket.
- Put the laundry down lightly.
- Place the safety cover horizontally on the laundry.
- Set the desired spin time with the spin timer.



Economic water supply rinse

- Interim spin rinse prior to regular rinsing helps removing sudsy water from the laundry and improve rinsing efficiency. Also is helpful to water saving.

- 1** After washing.
- Move the laundry into the spin dryer basket.
 - Place the safety cover horizontally on the laundry.



- 2** Set the water selector to "SPIN"



- 3** Supply the water to flow appropriately.
- 4** Stop water supply, close the safety cover-2 and spin dryer cover



- 5** Set the desired spin time with the spin timer



- 6** After interim spin rinse, move the laundry into the wash tub for rinsing.



- 7** Set the drain selector to "WASH · RINSE" position and feed appropriate water quantity to the wash tub.

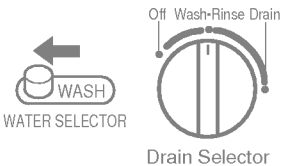

- 8** Set the rinse time with the wash timer

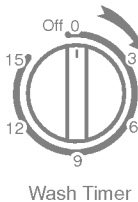



- 9** After rinsing, Move the laundry into the spin dryer basket and set the spin time with the spin timer.



- 10** Move the laundry into the wash tub and repeat step 7 to 9 for more rinsing.

Continuous water supply rinse

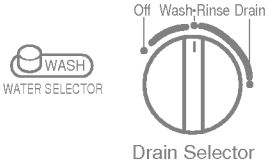
- This overflowing rinse is helpful to improve rinsing efficiency and remove the lint.

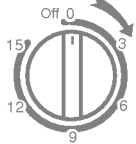
<p>1 Set the drain selector to "WASH • RINSE" position.</p>  <p>WATER SELECTOR</p> <p>Drain Selector</p>	<p>2 Put the laundry into the wash tub and supply the water.</p> 	<p>3 Set the rinse time with the wash timer and feed water continuously during the rinsing.</p>  <p>Wash Timer</p>
--------------------------------------------------------------------------------------------------------------------------------------------------------------------------------------------------	-----------------------------------------------------------------------------------------------------------------------------------------------------------	------------------------------------------------------------------------------------------------------------------------------------------------------------------------------------------------------------

- Put the laundry evenly into the spin dryer basket.
- Put the laundry down lightly.
- Place the safety cover horizontally over the laundry.
- Close the spin dryer cover.
- Set the spin timer according to the following table.

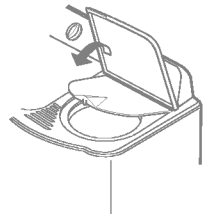
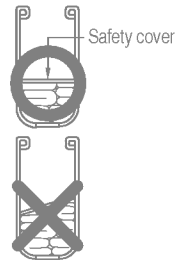

Type of clothing	Spin time
Thin fabrics (synthetic fabrics, mixed fabrics)	1 minute
Sweaters (synthetic fabrics)	1~3 minutes
Cotton underwear	3~5 minutes
Sheets, towels	5 minutes

- If the spin dryer basket is off-balance and vibrates excessively, stop the spinning, rearrange the clothes evenly, and then resume spinning.
- If spinning fail to stop within 15 seconds after the spin dryer cover is opened, the brake is out of order. Immediately stop using the machine and request repair service.

AFTER FINISHING

1. Remove the laundry from the spin dryer basket and close the spin dryer cover,
2. If there is water in the wash tub, set the drain selector to "DRAIN" in order to drain it out, and then put it back to "OFF"
3. Disconnect the power cord from the electrical outlet.
4. Clean the washing machine. (Refer to CARE AND MAINTENANCE on page 13~14.)
5. Ensure without fail the Drain Selector is thrned to "OFF" position after using the machine.

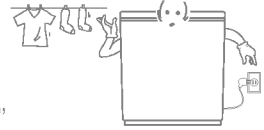

REFERENCE

TABLE 1. weight guide for clothes

Type of clothing	Type of fabric	Weight per piece
Under shirt	Cotton	150 g (53oz)
Handkerchief	Cotton	50 g (1.8oz)
Bath towel	Cotton	300 g (10.6oz)
Shirt	Mixed fabric	200 g (7.1oz)
Socks (1 pair)	Mixed fabric	50 g (1.8oz)
Pajama (shirt and pants)	Cotton	500 g (17.6oz)
Winter undershirt	Cotton	600 g (21.2oz)
Workclothes	Mixed fabric	800 g (28.2oz)
Blouse	Mixed fabric	200 g (7.1oz)

TABLE 2. GUIDE FOR WASHING

Type of fabric	Wash selector	Wash time	Amount of laundry	Water level	Amount of water	Amount of detergent
Synthetics, Silk, Woolen, Knits	GENTLE	2~5 min.	0.5~5.4 kg (1.1~11.9lb)	S	54 l	54 g(1.9 oz)
			5.4~6.5 kg (11.9~14.3lb)	L	65 l	65 g(2.3 oz)
			6.5~7.5 kg (14.3~16.5lb)	M	76 l	76 g(2.7 oz)
			7.5 kg~ (16.5lb~)	H	88 l	88 g(3.1 oz)
Cotton, Linen	NORMAL	5~10 min.	0.5~5.4 kg (1.1~11.9lb)	S	54 l	54 g(1.9 oz)
			5.4~6.5 kg (11.9~14.3lb)	L	65 l	65 g(2.3 oz)
			6.5~7.5 kg (14.3~16.5lb)	M	76 l	76 g(2.7 oz)
			7.5 kg~ (16.5lb~)	H	88 l	88 g(3.1 oz)
Very soiled cotton and linen	STRONG	10~15 min.	0.5~5.4 kg (1.1~11.9lb)	S	54 l	54 g(1.9 oz)
			5.4~6.5 kg (11.9~14.3lb)	L	65 l	65 g(2.3 oz)
			6.5~7.5 kg (14.3~16.5lb)	M	76 l	76 g(2.7 oz)
			7.5 kg~ (16.5lb~)	H	88 l	88 g(3.1 oz)

- Note :**
- Amount of laundry is a weight of dry laundry.
 - Detergent is a general synthetic detergent.
 - For better wash of lots of laundry, Using about 300mg of detergent is recommended. But if too much foam is made, decrease the amount of detergent.

- Be sure to disconnect the power cord from the electric outlet before starting care and maintenance.

Washing machine

- If the washing machine itself becomes dirty.
- The washing machine can be cleaned with a mild liquid detergent. Never use abrasive cleanser or chemicals such as benzene or thinner to clean the washing machine, because these materials will damage both the painted surfaces and the plastic parts.

Pulsator

- If a button or some other object gets caught in the pulsator.
1. Take out the pulsator cap with "-" type driver.
 2. Use a screwdriver to loosen the screw in the center of the pulsator, and lift the pulsator straight up in order to remove the button or other object.
 3. Replace the pulsator and tighten the screw.
 4. Replace the pulsator cap.

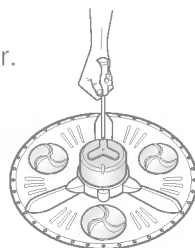

Overflow filter & Rotation filter-C

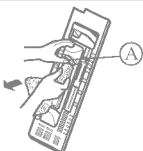
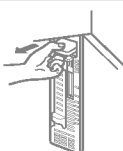
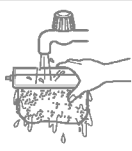
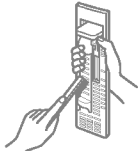
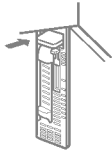
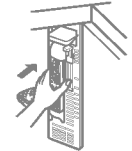
<p>1</p>  <ul style="list-style-type: none"> • Lift up the area A of the over flow filter. • Take out the rotation filter-C by pulling in direction shown. 	<p>2</p>  <ul style="list-style-type: none"> • Pull the overflow filter forward from the wash tub in the direction of the arrow. 	<p>3</p>  <ul style="list-style-type: none"> • Turn the net over and rinse in water
<p>4</p>  <ul style="list-style-type: none"> • Use a brush or your hand to remove all of the lints which has adhered to the overflow filter. 	<p>5</p>  <ul style="list-style-type: none"> • Insert the over flow filter back into the wash tub. 	<p>6</p>  <ul style="list-style-type: none"> • Insert the rotation filter-C back into the overflow filter.

- If only rotation filter-C need washing, proceed the process 1 → 3 → 6 on the upper figure.

Spin dryer basket

- If clothing becomes trapped between the spin dryer basket and the spin tub.
 1. Take hold of the front of the safety cover-1.
 2. Pull the tub by the other hand.
 3. Pull the safety cover-1 upward.
 4. Remove the article of clothing.
 5. Close the safety cover-1, pressing down on it so that it fits securely into the spin tub.
 6. Tighten the screw at the left corner in the safety cover-1.

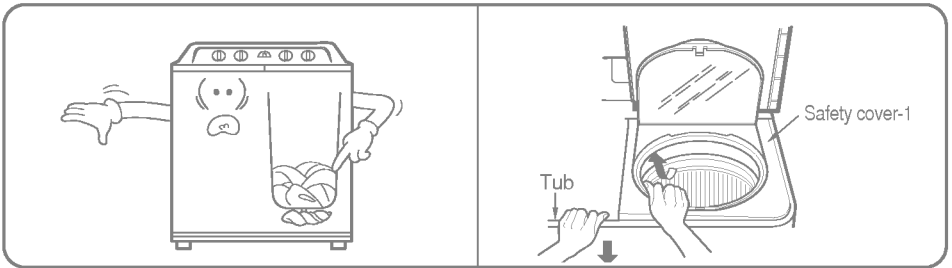

Before Requesting Service

Type of clothing	Checking point
Motor does not operate,	<ul style="list-style-type: none"> • Is the power cord firmly plugged in? • Is the timer turned to a suitable point except "OFF"?
Spin dryer basket does not operate.	<ul style="list-style-type: none"> • Is there any cloth dropped between the basket and tub? • Is the spin dryer cover closed? • Is the laundry gathered to one side of the spin dryer basket?
No draining	<ul style="list-style-type: none"> • Is the lint stuck to the plunger valve? • Is the end of the drain hose guide located at an exceed height? • Is the drain pump operated?

SPECIFICATIONS

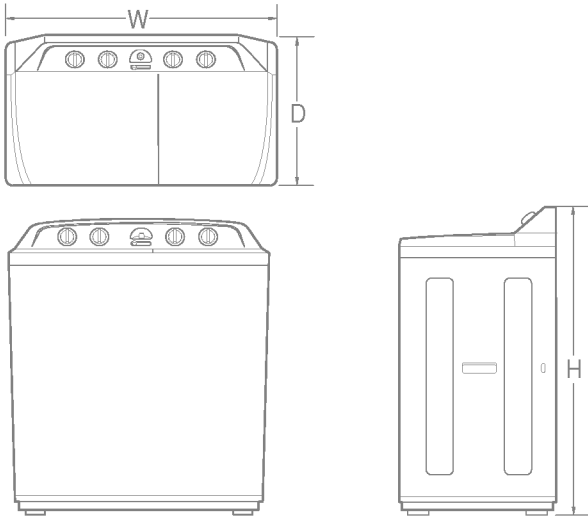

Power source	On SPECIFICATION LABEL
Water level	H : 88l, M : 76l, L : 65l, S : 54l
Water Pressure	Less than 100kPa (1kgf/cm ²)
Dimensions	895 × 530 × 1022mm. (W × D × H)
Weight (Net)	39.5 kg

- How to read the manufactured month and year from the label stuck on the back of the product.

EX) 2 1 2 T W 0 0 0 1

Serial No.

Product code

Month : December

Year (The last digit to year) : 2002

- Main service parts list : Refer to below listed parts name when you need service call.

Part name	Remark
- WASH MOTOR	105W
- SPIN MOTOR	105W
- S.D. BASKET	PLASTIC (STAINLESS for model WP-1510Q(S)P)
- CYCLE TIMER ASM	
- CAPACITOR	
- GEAR CASE ASM	

