



website <http://www.lgservice.com>
e-mail <http://www.lgservice.com> support.html

LG

Window-Type Air Conditioner

OWNER'S MANUAL

MODELS: LWC182PLAB0, LWC182PLMM0
LWH182PLAB0, LWH182PLMM0
LWC242PLAB0, LWC242PLMM0

Please read through this manual. It contains valuable information about your air conditioner. This manual may help save time and money by explaining proper air conditioner maintenance and preventing improper use.

Pay close attention to precautions in order to prevent potential hazards and damage from misuse or improper installation. LG is not responsible for any damages caused by misuse of the air conditioner.

TABLE OF CONTENTS



For Your Records

Write the model and serial numbers here:

Model # _____

Serial # _____

You can find them on a label on the side of each unit.

Dealer's Name _____

Date Purchased _____

Read This Manual

Inside you will find many helpful hints on how to use and maintain your air conditioner properly. Just a little preventive care on your part can save you a great deal of time and money over the life of your air conditioner.

You'll find many answers to common problems in the chart of troubleshooting tips. If you review our chart of **Troubleshooting Tips** first, you may not need to call for service at all.



CAUTION

- Contact the authorized service technician for repair or maintenance of this unit.
- Contact the installer for installation of this unit.
- The air conditioner is not intended for use by young children or invalids without supervision.
- Young children should be supervised to ensure that they do not play with the air conditioner.

To prevent injury and property damage, follow these instructions. Incorrect operation due to ignoring instructions will cause harm or damage, the seriousness of which is indicated by the following symbols.



WARNING This symbol shows the possibility of death or serious injury.



CAUTION This symbol indicates the possibility of injury or damage to property.



Never Do This



Always Do This

■ The following items are classified by these symbols.

WARNING



• Otherwise, it will cause electric shock or fire due to heat generation or electric shock.



• It will cause electric shock or fire due to heat generation.



• It will cause electric shock or fire.
• If the supply cord is damaged, it must be replaced by the manufacturer or its service agent or a similarly qualified person in order to avoid a hazard. (Y attachment)



• It will cause electric shock or fire due to heat generation.



• It will cause electric shock.



• No grounding may cause electric shock (See Installation Manual).



• It will cause failure of machine or electric shock.



• No installation may cause fire and electric shock accident.



• It may cause fire and electric shock accident.



• It may cause fire and electric shock.



• It may cause electric shock.



• It may cause fire.



• It may cause fire and electric shock.



• It may cause an explosion or fire.



WARNING

Do not breathe before operating air conditioner when gas goes out.

- It may cause explosion, fire, and burn.

Do not disassemble or modify products.

- It may cause failure and electric shock.



CAUTION

Do not touch the metal parts of the unit when the fan is running.

- They are sharp and may cause injury.

Do not clean the unit with water.

- Water may enter the unit and degrade the insulation. It may cause an electric shock.

Do not ventilate well when used in a room with animals.

- An oxygen shortage may occur.

When cleaning the unit, first make sure the power is turned off.

- Since the fan rotates at high speed during operation, it may cause injury.

Do not put a pet or house plant where it will be blown by the fan.

- This could injure the pet or plant.

Do not use appliance or special plug, such as animal, vegetable, or property.

- It may cause damage of animals or vegetables or loss of property.

Do not operate in storm or heavy rain.

- Operation with windows opened may cause wetting of indoor and soaking of household furniture.

Do not pull the plug by the head.

- It may cause electric shock and damage.

Do not turn off the main power.

- It may cause failure of product or fire.

Do not place obstacles in front of the air outlet.

- It may cause failure of appliance or accident.

Do not use an installation console of the unit as a table.

- If leaving appliance damaged, there is concern of damage due to the falling of product.

Do not insert the filters.

- Operation without filters will cause failure.

Do not use strong detergent.

- Appearance may be deteriorated due to change of product color or scratching of its surface.

Do not place heavy object on the top of the unit.

- There is danger of fire or electric shock.

Do not drink water drained from the unit.

- It contains containments and will make you sick.

Do not let water enter the product. Turn off the power switch of the main board.

Do not direct airflow at room occupants only.

- This could damage your health.

- 
- Contact an installation specialist for installation.
 - Plug in the power plug properly.
 - Do not share the same outlet with other appliances
 - Do not use an extension cord.
 - Do not start/stop operation by plugging/unplugging the power cord.
 - If cord/plug is damaged, replace only with an authorized part.

- 
- Being exposed to direct airflow for an extended period of time could be hazardous to your health. Do not expose occupants, pets, or plants to direct airflow for extended periods of time.
 - Due to the possibility of oxygen deficiency, ventilate the room when used together with stoves or other heating devices.
 - Do not use this air conditioner for non-specified special purposes (e.g. preserving precision devices, food, pets, plants, and art objects). Usage in such a manner could harm such property.

- 
- Do not touch the metal parts of the unit when removing the filter. Injuries can occur when handling sharp metal edges.
 - Do not use water to clean inside the air conditioner. Exposure to water can destroy the insulation, leading to possible electric shock.
 - When cleaning the unit, first make sure that the power and breaker are turned off. The fan rotates at a very high speed during operation. There is a possibility of injury if the unit's power is accidentally triggered on while cleaning inner parts of the unit.



For repair and maintenance, contact your authorized service dealer.



The remote control and control panel will look like one of the following pictures.

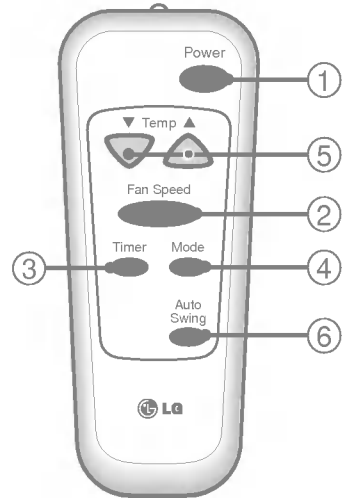
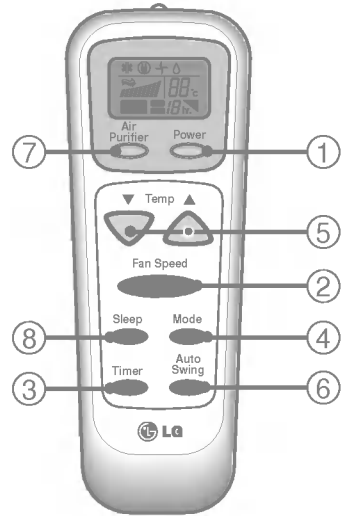
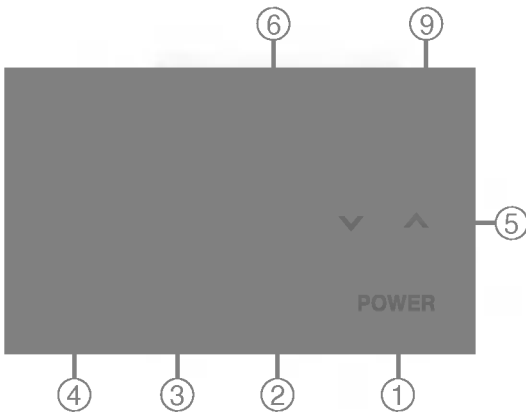
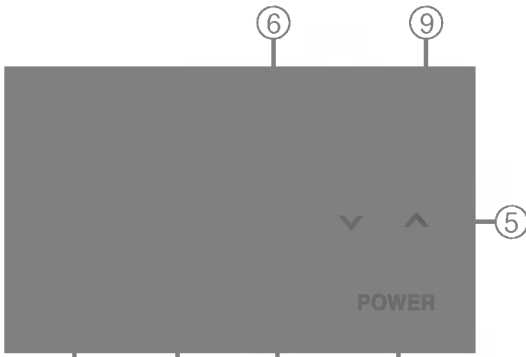
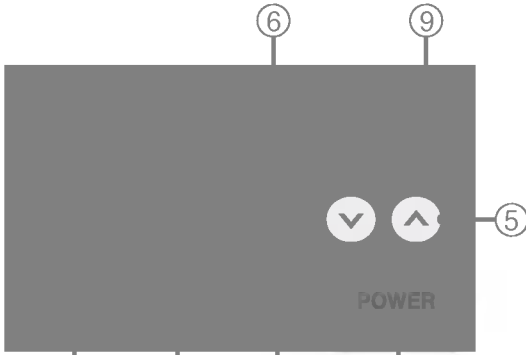

● POWER

Operation starts when this button is pressed and stops when you press the button again.

● FAN SPEED SELECTOR

For increased power while cooling, select a higher fan speed.

3 steps: High → Low → Med

● ON/OFF TIMER

The timer can be set to start and stop the unit in hourly increments (up to 12 hours).

● OPERATION MODE SELECTOR

Select cooling mode to cool the room.

Select energy saver mode for energy saving operation.

Select fan mode for basic ventilating fan operation.

Select dry mode for dry operation.

Select heFat mode for heating operation.

* Defrost mode is made automatically when the frost settles on the heat exchanger of the outside.

● TEMPERATURE CONTROL

The thermostat monitors room temperature to maintain the desired temperature.

The thermostat can be set between 16°C~30°C.

The unit takes an average of 30 minutes to adjust the room temperature by 1°C.

● AUTO SWING

This button can automatically control the air flow direction.

● AIR PURIFIER

• Press the Air Purifier button. Operation will start when the button is pressed and stop when the button is pressed again.

• Set the fan speed again with the remote control. You can select the fan speed in three steps-high, low or medium.

Each time the button is pressed, the fan speed mode is shifted.

• If you press the only Air Purifier button, only air purifying operates without cooling.

Then, fan speed is low.

You can select the fan speed in three steps; high, low, or medium.

Each time the fan speed button is pressed, the fan speed mode is shifted.

● SLEEP MODE

• Press the sleep mode button to set the time you want the unit to turn off automatically.

• Every time you push this button, the remaining time will be set as follows. (1Hour → 2Hours → 3Hours → 4Hours → 5Hours → 6Hours → 7Hours → 0Hours → 1Hour → 2Hours → ...)

● REMOTE CONTROL SENSOR

In failure of electric power, the unit runs as previous setting operation.

- Push out the cover on the back of the remote control with your thumb
- Pay attention to polarity and insert two new AAA 1.5V batteries.
- Reattach the cover.



NOTE: Do not use rechargeable batteries. Make sure that both batteries are new.

- In order to prevent discharge, remove the batteries from the remote control if the air conditioner is not going to be used for an extended period of time
- Keep the remote control away from extremely hot or humid places.

To maintain optimal operation of the remote control, the remote sensor should not be exposed to direct sunlight.

- The remote control can be mounted on a wall using the mountable holder.

The controls will look like one of the following.

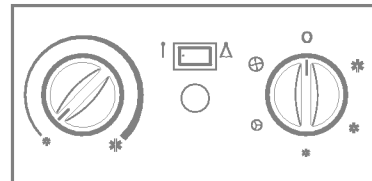
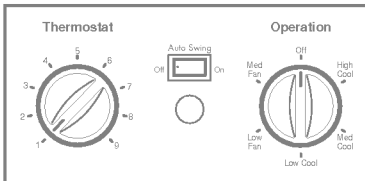
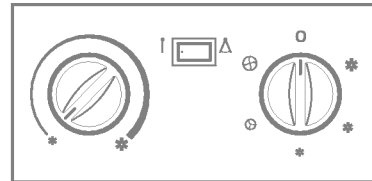
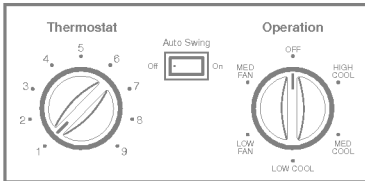
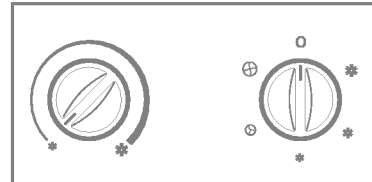
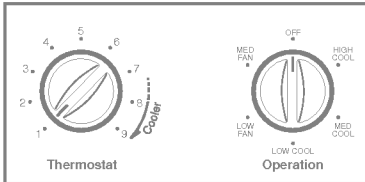
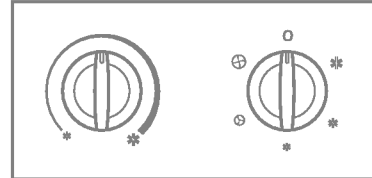
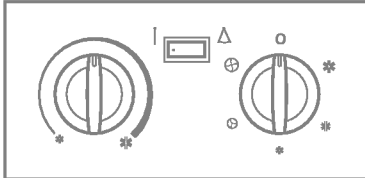
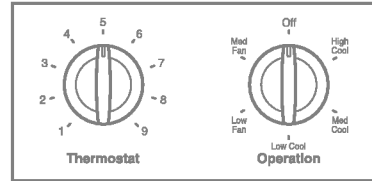
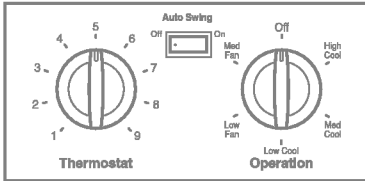
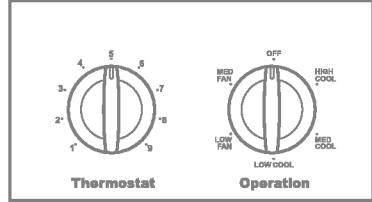
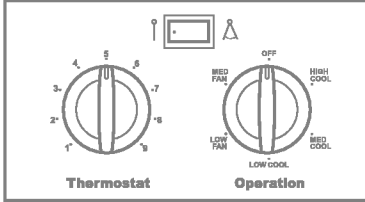

■ OPERATION

High Cool (❄️), **Med Cool** (❄️) and

Low Cool (❄️) provide cooling with different fan speeds. **Med Fan** (⌚) or **Low Fan** (⌚) provides air circulation and filtering without cooling. **Off** (⓪) turns the air conditioner off.

***NOTE:** If you move the switch from a cool setting to off or to a fan setting, wait at least 3 minutes before switching back to a cool setting.*

Cooling Descriptions

For Normal Cooling- Select **High Cool** or **Med Cool** with the **Operation** knob at the midpoint of **Thermostat** knob.

For Maximum Cooling- Select **High Cool** with the **Operation** knob at the highest number available on your **Thermostat** knob.

For Quieter & Nighttime Cooling- Select **Low Cool** with the **Operation knob** at the midpoint of **Thermostat** knob.

■ THERMOSTAT

The **THERMOSTAT** is used to maintain the room temperature. The compressor will cycle on and off to keep the room at the same level of comfort. When you turn the knob to a higher number(the right side) and the indoor air will become cooler.

The **5** or **6** position (the middle position of arc) is a normal setting for average conditions.

■ AUTO SWING

Auto swing switch controls the horizontal air direction by air swing system (not on all models).

ON (⚡) : Auto swing is operated.

OFF (⚡) : Auto swing is not operated.



CAUTION

When the air conditioner has been performed its cooling operation and is turned off or set to the fan position, wait at least 3 minutes before resetting to the cooling operation again.

The controls will look like one of the following.

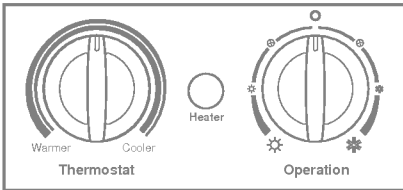
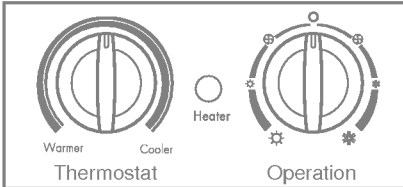
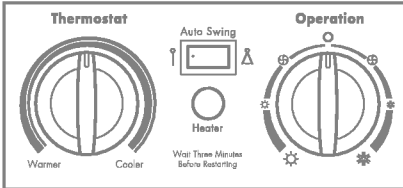
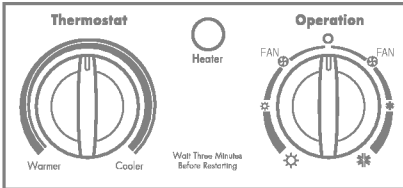
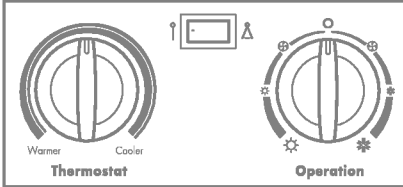

■ AUTO SWING (for some models)

ON (): Air swing is operated while OPERATION knob is set to the COOL or HEAT position.

OFF (): Stops the operation of air swing.

■ THERMOSTAT

Turn the thermostat control to the desired setting. The control position is a normal setting for average conditions. You can change this setting, if necessary, in accordance with your temperature preference.

The thermostat automatically controls cooling or heating, but the fan runs continuously whenever the air conditioner is in operation. If the room is too warm, turn the thermostat control clockwise. If the room is too cool, turn the thermostat control counterclockwise.

■ HEATER () LAMP

When the unit sets heating operation condition, the green lamp is lighted.

When the frost settles on the heat exchanger of the outside, defrosting is made automatically and the green lamp is turned off.

The unit may give a "hiss" and the fan motor stops for 1 to 10 minutes.

This should not be regarded as a problem.

After defrosting, the heating operation begins again.

■ OPERATION

OFF (): Turns the air conditioner off.

LOW FAN (): Permits the low fan speed operation without cooling (heating).

LOW COOL (): Permits cooling with the low fan speed operation.

HIGH COOL (): Permits cooling with the high fan speed operation.

LOW HEAT (): Permits heating with the low fan speed operation.

HIGH HEAT (): Permits heating with the high fan speed operation.

CAUTION

When the air conditioner has been performed its cooling operation and is turned off or set to the fan position, wait at least 3 minutes before resetting to the cooling operation again.

For maximum cooling efficiency, CLOSE the vent. This will allow internal air circulation.
OPEN the vent to discharge stale air.

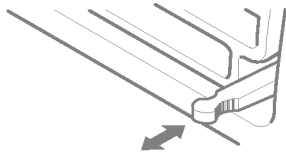

CLOSE ■ VENT ■ OPEN

NOTE : Before using the ventilation feature, position the vent lever straight by pulling Part A out and snapping it into place.

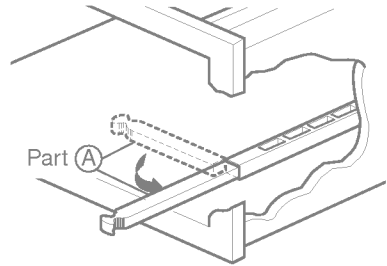

Airflow can be adjusted by changing the direction of the air conditioner's louvers. This can also increase the cooling efficiency of the air conditioner.

• **Adjusting Horizontal Air Flow Direction**

Control the horizontal air direction by air swing system.

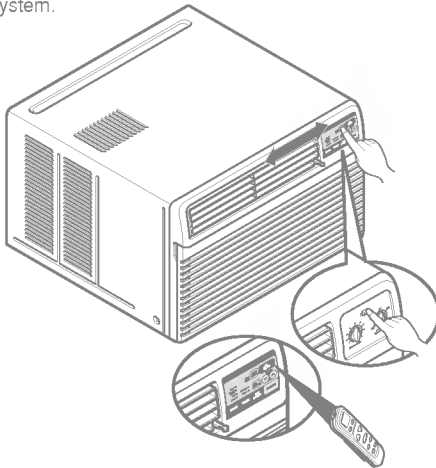

Adjusting horizontal air flow

• **Adjusting Vertical Air Flow Direction**

Adjusting the horizontal vane up and down will change vertical airflow. The vane can be adjusted by nudging the back or up and down of the vane.

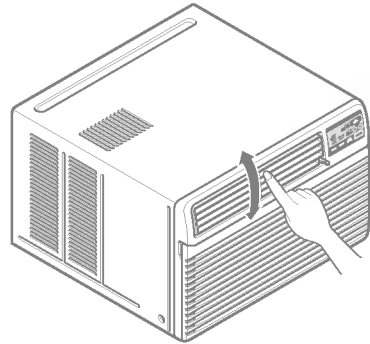

Adjusting vertical air flow

• **Recommended orientation of louvers**

Adjust louvers to face upwards when cooling to maximize cooling efficiency.

Turn the power off and unplug the power plug before cleaning the air conditioner.

The air filter behind the inlet grille should be checked and cleaned at least once every 2 weeks (or as necessary) to maintain optimal performance of the air conditioner.

How to remove the air filter

- The grille may be opened from the top for easy maintenance after installation.
- Open the inlet grille by pulling off the exposed door on the top of the unit (based on installation).
- Pull the tab slightly to release the filter. Pull the filter in the same direction as the opening.
- Clean the filter with warm, soapy water. The water should be below 40°C.
- Rinse off and gently shake off excess water from the filter. Let it dry before replacing it.

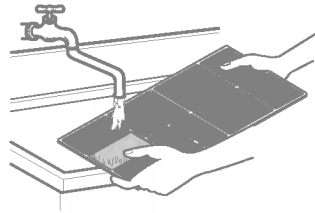
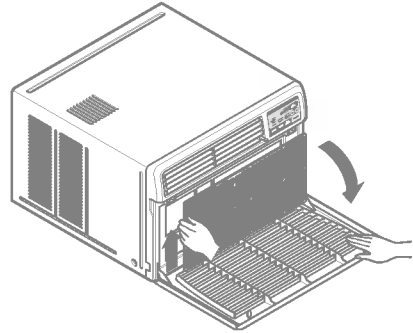

The base pan may overflow due to high humidity. To drain the excess water, remove the drain cap from the back of the unit and secure the drainpipe.

When pressing the drainpipe into place, apply force in the direction away from the fins to avoid injuring yourself.

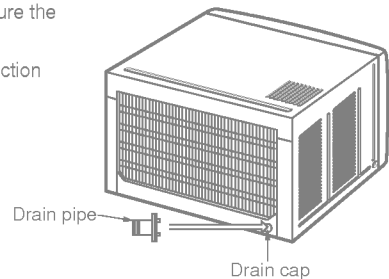

The Air Purifying filter behind the air filter should be checked and cleaned once every 3 months or more often if necessary.

- After removing the Air Purifying Filter, pull slightly forward to remove the Air Purifying filter.
- Soak the Air Purifying Filter in water mixed with a mild detergent for 20~30 minutes.
- Dry the Air Purifying Filter in the shade for a day. (The moisture must be removed completely on this part.)
- Note the cuts of electric discharge lines.
- Re-install the Air Purifying Filter to the original position.

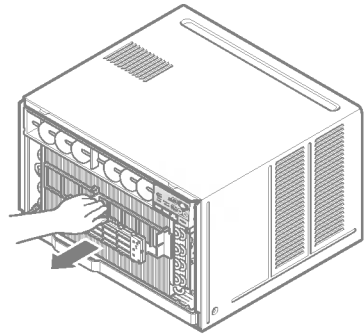

Don't touch this Air Purifying Filter within 10 seconds after opening the inlet grille; it may cause an electric shock.

The air conditioner employs a proper drain method whereby the condensed water (moisture removed from the air) is drained to the outside.

In very humid weather, (and for reverse cycle models in the reverse mode) excessive condensate water removed from the air may cause some water to collect. To remove this excess water you can install the drain pan as detailed below.

- Take the drain pan which is located in the air discharge.
- Remove the hole rubber from the base-pan (for some models).
- Install the drain pan to the right corner of the cabinet with 4 (or 2) screws.
- Connect the drain hose of 3/5" inside diameter to the outlet located at the bottom of the drain pan. You can purchase the drain hose or tubing locally to satisfy your particular needs. (Drain hose is not supplied).

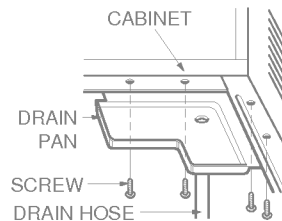



CAUTION

This appliance should be installed in accordance with national wiring regulations. This guide acts as a guide to help to explain product features.

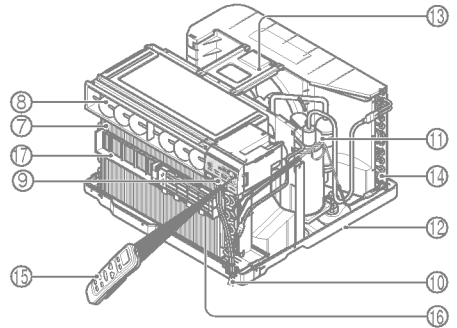
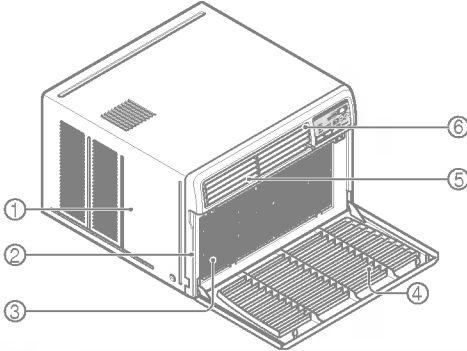

1. CABINET
2. FRONT GRILLE
3. AIR FILTER
4. AIR INTAKE (INLET GRILLE)
5. AIR DISCHARGE
6. VERTICAL AIR DEFLECTOR (HORIZONTAL LOUVER)
7. EVAPORATOR
8. HORIZONTAL AIR DEFLECTOR (VERTICAL LOUVER)

9. CONTROL PANEL
10. POWER CORD
11. COMPRESSOR
12. BASE PAN
13. BRACE
14. CONDENSER
15. REMOTE CONTROLLER
16. AIR PURIFYING FILTER (Optional)
17. CASE, FILTER (Optional)

You can choose between two methods below according to your window stool shape and preference.

- Fasten the stopper using 2 screw holes, and lead out the power cord through slit "A".

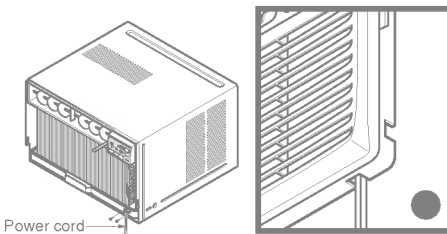

- Fasten the stopper using left screw hole, and rotate properly to lead the power cord out through slit "B".

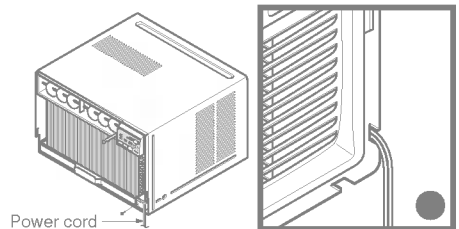

- Attach the front grille to the cabinet by inserting the tabs on the grille into the tabs on the front of the cabinet. Push the grille in until it snaps into place. (See Fig.1)

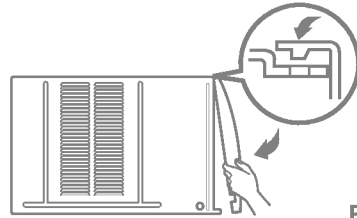

Fig. 1

- Lift the inlet grille and secure it with a screw through the front grille. (See Fig. 2)

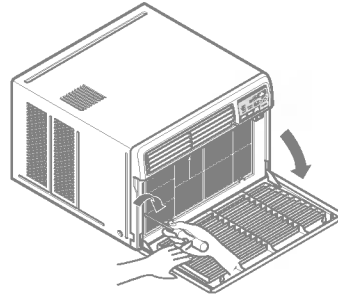

Fig. 2

How to Connect a Drain Hose

A drain hole is provided at the rear of the air conditioner unit.

Select a drain method according to the following.

- Remove the hole rubber from the base-pan. (for some models)
- Connect a drain hose to the drain pipe as shown in Fig. 3.
- Or connect a pipe elbow to the drain pipe, then connect a drain hose to the pipe elbow as shown in Fig. 4.

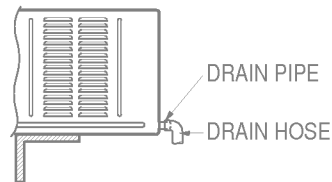

Fig. 3

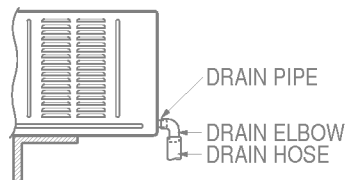
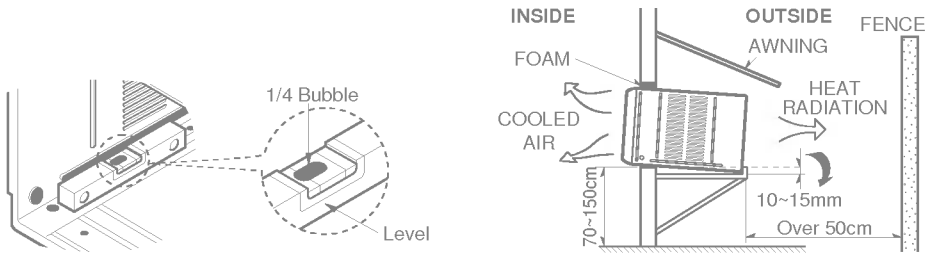

Fig. 4



- To avoid vibration and noise, make sure the unit is installed securely and firmly.
- Install the unit where the sunlight does not shine directly on the unit.
If the unit receives direct sunlight, build an awning to shade the cabinet.
- There should be no obstacle, like a fence, within 50cm which might restrict heat radiation from the condenser.
- To prevent reducing performance, install the unit so that louvers of the cabinet are not blocked.
- Install the unit a little obliquely outward not to avoid leaking the condensed water into the room (10~15mm or 1/4 bubble with level).
- Install the unit with its bottom portion 70~150cm above the floor level.
- Stuff the foam between the top of the unit and the wall to prevent air and insects from getting into the room.
- The power cord must be connected to an independent circuit. The green wire must be grounded.
- Connect the drain tube to the base pan hole in the rear side if you need to drain (consult a dealer.)
Plastic hose or equivalent may be connected to the drain tube.

Before calling for service, please review the following list of common problems and solutions.

The air conditioner is operating normally when:

- You hear a pinging noise. This is caused by water being picked up by the condenser on rainy days or in highly humid conditions. This feature is designed to help remove moisture in the air and improve cooling efficiency.
- You hear the thermostat click. This is caused by the compressor cycle starting and stopping.
- You see water dripping from the rear of the unit. Water may be collected in the base pan in highly humid conditions or on rainy days. This water overflows and drips from the rear of the unit.
- You hear the fan running while the compressor is silent. This is a normal operational feature.

The air conditioner may be operating abnormally when:

<p>The air conditioner does not operate at all</p>	<ul style="list-style-type: none"> ■ The air conditioner is unplugged or not plugged in completely ■ The fuse is blown/circuit breaker is triggered ■ Power failure. 	<ul style="list-style-type: none"> • Make sure the plug is completely plugged into the outlet • Check the fuse/circuit breaker box and replace the fuse or reset the breaker • In the event of a power failure, set the power control to OFF. When the power is restored, wait 3 minutes to restart the air conditioner to prevent the compressor from overloading
<p>Air conditioner does not cool</p>	<ul style="list-style-type: none"> ■ Air flow is restricted ■ The THERMOSTAT may not be set cool enough ■ The air filter is dirty. ■ The air conditioner was just turned on. ■ Cold air is escaping. ■ Cooling coils are iced up 	<ul style="list-style-type: none"> • Make sure there are no curtains, blinds, furniture or other obstacles in front of the air conditioner • Turn the knob to a higher setting. The highest setting provides maximum cooling • Clean the filter at least every 2 weeks. Refer to the "Care and Maintenance" section (p.9) of the manual. • After the air conditioner is turned on, you need to give the air conditioner some time to cool the room. • Check for open furnace floor registers and cold air returns. • CLOSE the air conditioner vent • See Ice appears on the air conditioner below
<p>Ice appears on the air conditioner.</p>	<ul style="list-style-type: none"> ■ The cooling coils are iced over. 	<ul style="list-style-type: none"> • Ice may block the air flow and obstruct the air conditioner from properly cooling the room. Set the fan at MED or HIGH while setting the thermostat at 1 or 2 until the ice melts.

MODEL	LWC182PLAB0	LWC182PLMM0	LWH182PLAB0	LWH182PLMM0	LWC242PLAB0	LWC242PLMM0
CAPACITY (BTU/h)	18,000	18,000	18,000	18,000	24,000	24,000
VOLTAGE (V)	220	220	220	220	220	220
FREQUENCY (Hz)	60	60	60	60	60	60
CURRENT (A)	8.8	8.8	9.0	9.0	11.5	11.5
POWER (W)	1,890	1,890	1,930	1,930	2,440	2,440
DIMENSIONS (W x H x D) (mm)	660 x 428 x 675					

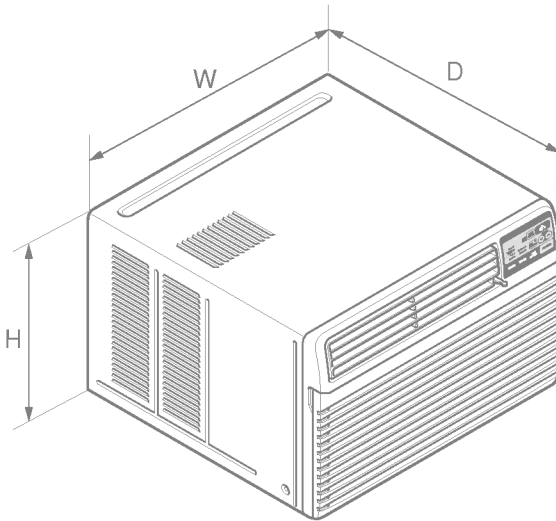

Details of LG serial No.

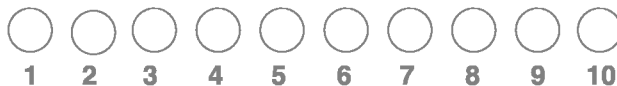

Code	Detail	Code of Model	Meaning
1	Year	0~9 (Digit)	The last digit of year ex) 1997 → 7, 2000 → 0
2,3	Month	01~12 (Digit)	Month ex) March → 03, August → 08
4	Nation	A~Z (Alphabet)	Where manufactured ex) K → Korea, C → China
5	Product	A~Z (Alphabet)	ex) A → Airconditioner
6~10	Serial No.	0~9 (Digit)	Production Quantity

H. G. IBRAHIM SHAKER COMPANY, LTD.
SERVICE CENTER

- * JEDDAH → P. O. BOX 50, JEDDAH 21411 KINGDOM OF SAUDI ARABIA
TEL NO. : 6422952 / 6425527
- * RIYADH → P. O. BOX 15, RIYADH 11411 KINGDOM OF SAUDI ARABIA
TEL NO. : 4020570
- * AL-KHOBAR → P. O. BOX 78, AL-KHOBAR 31952 KINGDOM OF SAUDI ARABIA
TEL NO. : 8943714

