



Room Air Conditioner OWNER'S MANUAL

- Please read carefully and thoroughly this manual before operating this unit.
- Contact the authorized SVC man for repair or maintenance of this unit.
- Contact the installer for installation of this unit.
- The appliance is not intended for use by young children or infirm persons without supervision.
- Young children should be supervised to ensure that they do not play with the appliance.

Prior to installation, the air-conditioning unit must be submitted for approval by the utility service which provides electricity (EN 61000-3 Noise)

Safety precautions

To prevent injury and property damage, follow these instructions.

 Incorrect operation due to ignoring instructions will cause harm or damage, the seriousness of which is indicated by the following symbols.

WARNING

This symbol shows the possibility of death or serious injury.

CAUTION

This symbol indicates the possibility of injury or damage to property.

■ The following items are classified by these symbols.

	Never Do This
	Always Do This

WARNING

• Otherwise, it will cause electric shock or fire due to heat generation or electric shock.

• It will cause electric shock or fire due to heat generation.

• It will cause electric shock or fire.
• In the supply cord is damaged, it must be replaced by the manufacturer or its service agent or a similarly qualified person in order to avoid a hazard. (Y Attachment)

• It will cause electric shock or fire due to heat generation.

• It may cause electric shock.

• This could damage your health.

• No grounding may cause electric shock.

• It may cause failure of machine or electric shock.

• No installation may cause fire and electric shock accident.

• It may cause fire and electric shock accident.

• It may cause fire and electric shock.

• It may cause electric shock.

• It may cause fire.

• It may cause fire and electric shock.

• It may cause an explosion or fire.

WARNING



- It may cause explosion, fire and, burn.



- It may cause failure and electric shock.

CAUTION



- They are sharp and may cause injury.



- Water may enter the unit and degrade the insulation. It may cause an electric shock.



- An oxygen shortage may occur.



- Since the fan rotates at high speed during operation, it may cause injury.



- This could injure the pet or plant.



- It may cause damage of animals or vegetables or loss of property.



- Operation with windows opened may cause wetting of indoor and soaking of household furniture.



- It may cause electric shock and damage.



- It may cause failure of product or fire.



- It may cause failure of appliance or accident.



- If leaving appliance damaged, there is concern of damage due to the falling of product.



- Operation without filters may cause failure.



- Appearance may be deteriorated due to change of product color or scratching of its surface.



- There is danger of fire or electric shock.



- It contains contaminants and will make you sick.



Preparation before operation

How to Insert the Batteries

- 1 Remove the battery cover by pulling it according to the arrow direction.
- 2 Insert new batteries making sure that the (+) and (-) of battery are installed correctly.
- 3 Reattach the cover by sliding it back into position.

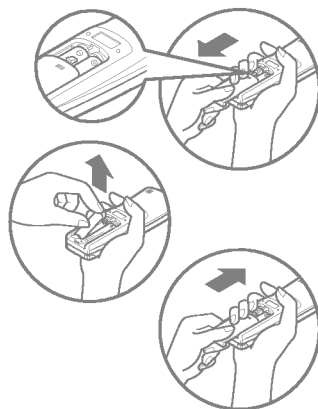

NOTES:

- Use 2 AAA(1.5volt) batteries. Do not use rechargeable batteries.

Storage and Tips For Using the Remote Control

- The remote control may be stored by mounting it on a wall.
- To operate the room air conditioner, aim the remote control at the signal receptor.

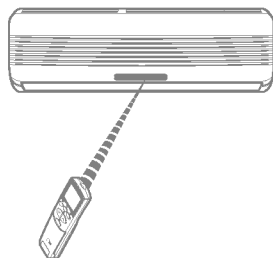
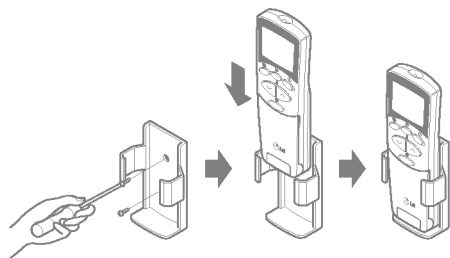

Signal Receptor

Receives the signals from the remote control.(Signal receiving sound: two short beeps or one long beep.)

Operation Indication Lamps

- ⓘ On/Off : Lights up during the system operation.
- ☆ Sleep Mode : Lights up during Sleep Mode Auto operation.
- ⌚ Timer : Lights up during Timer operation.
- ❄️ Defrost Mode : Lights up during Defrost Mode or Hot Start operation (Heat pump model only)
- OUT DOOR OPERATION : Lights up during outdoor unit operation. (Cooling model only)
- ☾ Plasma : The function illustrates its dynamic mode by using a multiple lighting system.

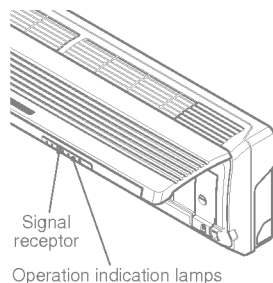

Signal receptor
Operation indication lamps

About the remote control on the system

The remote control transmits the signals to the system.



Features of the Remote Control- Door Opened

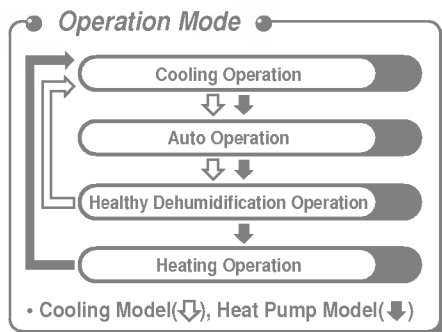
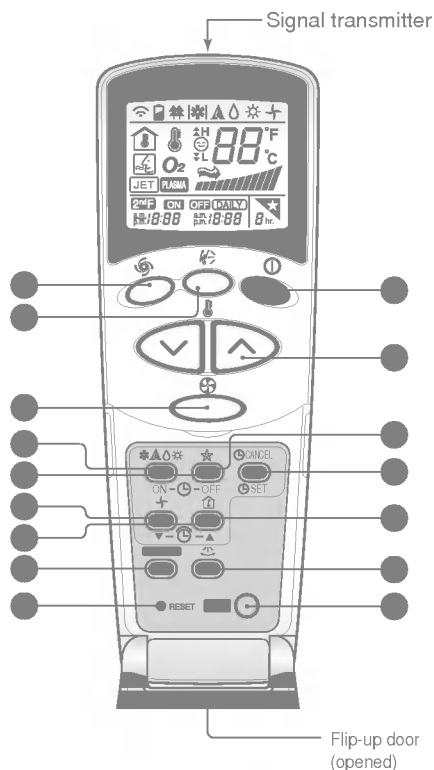

- **START/STOP BUTTON**
Operation starts when this button is pressed and stops when the button is pressed again.
- **OPERATION MODE SELECTION BUTTON**
Used to select the operation mode.
- **ROOM TEMPERATURE SETTING BUTTONS**
Used to select the room temperature.
- **INDOOR FAN SPEED SELECTOR**
Used to select fan speed in four steps low, medium, high and CHAOS.
- **JET COOL**
Used to start or stop the speed cooling. (Speed cooling operates super high fan speed in cooling mode.)
- **CHAOS SWING BUTTON**
Used to stop or start lower movement and set the desired up/down airflow direction.
- **ON/OFF TIMER BUTTONS**
Used to set the time of starting and stopping operation. (See page 13)
- **TIME SETTING BUTTONS**
Used to adjust the time. (See page 13)
- **TIMER SET/CANCEL BUTTON**
Used to set the timer when the desired time is obtained and to cancel the Timer operation. (See page 13)
- **SLEEP MODE AUTO BUTTON**
Used to set Sleep Mode Auto operation. (See page 13)
- **AIR CIRCULATION BUTTON**
Used to circulate the room air without cooling or heating. (See page 14)
- **ROOM TEMPERATURE CHECKING BUTTON**
Used to check the room temperature.
- **PLASMA(OPTIONAL)**
Used to start or stop the plasma-purification function. (See page 11)
- **HORIZONTAL AIRFLOW DIRECTION CONTROL BUTTON (NOT ON ALL MODELS)**
Used to set the desired horizontal airflow direction. (See page 14)
- **RESET BUTTON**
Used prior to resetting time or after replacing batteries.
- **2nd F Button**
Used prior to using modes printed in blue at the bottom of buttons. (See page 12)



How to use the Operation Mode Selection button

Cooling Operation

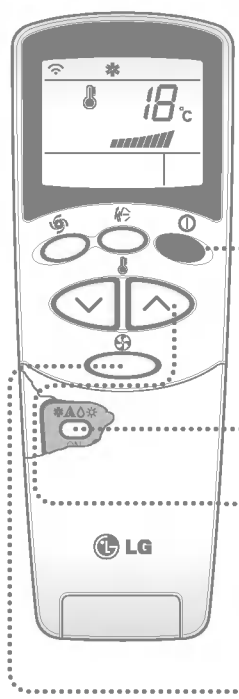

1 Press the Start/Stop button. The unit will respond with a beep.

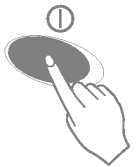

2 Open the door on the remote control. To select **Cooling Operation**, press the Operation Mode Selection button. Each time the button is pressed, the operation mode is shifted in the direction of the arrow.

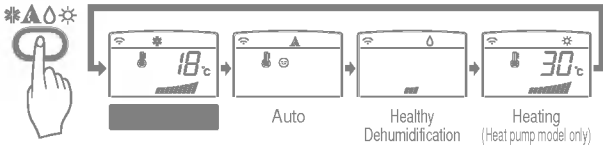

3 Close the door on the remote control. Set the temperature lower than the room temperature. The temperature can be set within a range of 18°C~30°C in 1°C increments.

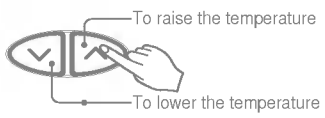

4 Set the fan speed again with the door of the remote control still closed. You can select the fan speed in four steps—low, medium, high and CHAOS. Each time the button is pressed, the fan speed mode is shifted.



Natural wind by the CHAOS logic

- For more fresh feeling than other fan speed, press the Indoor Fan Speed Selector and set to CHAOS mode. In this mode, the wind blows like natural breeze by automatically changing fan speed according to the CHAOS logic.



Auto Operation

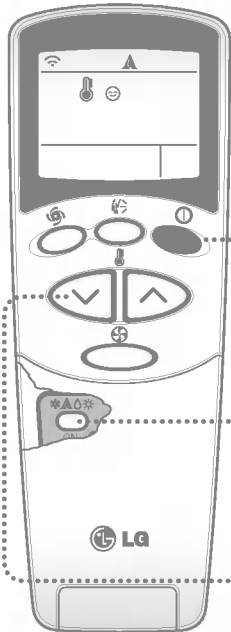

- 1 Press the Start/Stop button.
The unit will respond with a beep.



- 2 Open the door on the remote control. To select **Auto Operation**, press the Operation Mode Selection button. Each time the button is pressed, the operation mode is shifted in the direction of the arrow.

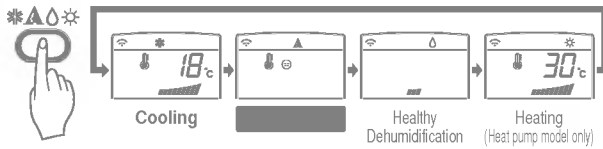

- 3 The temperature and fan speed are automatically set by the electronic controls based on the actual room temperature. If you want to change the set temperature, press the Room Temperature Setting buttons. The cooler or warmer you feel, the more times (up to two times) you should press the button. The set temperature will be changed automatically.

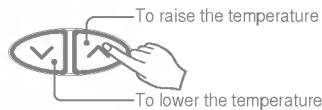

During Auto Operation:

- You cannot switch the indoor fan speed. It has already been set by the Fuzzy rule.
- If the system is not operating as desired, manually switch to another mode. The system will not automatically switch from the cooling mode to the heating mode, or from heating mode to cooling mode, it must be done by manually resetting.
- During Auto Operation, pressing the chaos swing button makes the horizontal louvers swing up and down automatically. If you want to stop auto-swing, press the chaos swing button again.



Healthy Dehumidification Operation

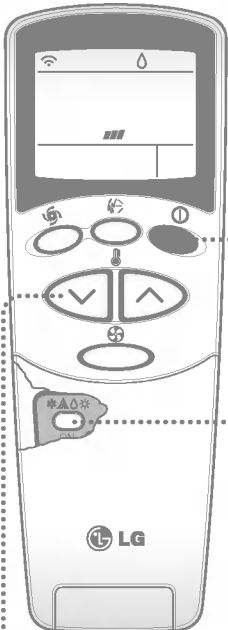

- 1 Press the Start/Stop button.
The unit will respond with a beep.



- 2 Open the door on the remote control. To select **Healthy Dehumidification Operation**, press the Operation Mode Selection button.
Each time the button is pressed, the operation mode is shifted in the direction of the arrow.

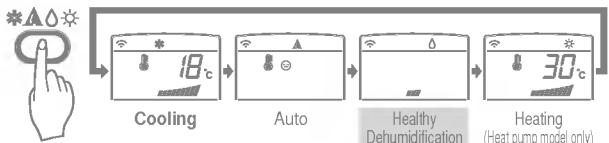

- 3 Set the fan speed again with the door of the remote control still closed. You can select the fan speed in four steps—low, medium, high, or CHAOS. Each time the button is pressed, the fan speed mode is shifted.



Natural wind by the CHAOS logic

- For more fresh feeling than other fan speed, press the Indoor Fan Speed Selector and set to CHAOS mode. In this mode, the wind blows like natural breeze by automatically changing fan speed according to the CHAOS logic.

During Healthy Dehumidification Operation:

- If you select the dehumidification mode on the operation selection button, the A/C starts to run the dehumidification function. It automatically sets the room temp. and airflow volume to the best condition for dehumidification, based on the sensed current room temp.

In this case, however, the setting temp. is not displayed in the remote control and you are not able to control the room temp. either.

- During the healthy dehumidification function, the airflow volume is automatically set according to the optimization algorithm responding to the current room temp. status which makes the room condition healthy and comfortable even in the high humidity season.



Heating Operation(Heat pump model only)

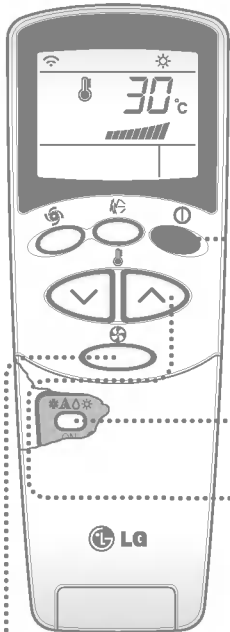

- 1 Press the Start/Stop button.
The unit will respond with a beep.



- 2 Open the door on the remote control. To select **Heating Operation**, press the Operation Mode Selection button. Each time the button is pressed, the operation mode is shifted in the direction of the arrow.

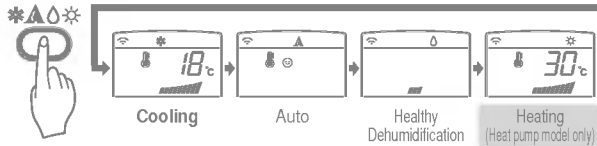

- 3 Close the door on the remote control. Set the temperature higher than the room temperature. The temperature can be set within a range of 16°C~30°C in 1°C increments.

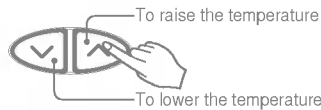

- 4 Set the fan speed again with the door of the remote control still closed. You can select the fan speed in four steps—low, medium, high and CHAOS. Each time the button is pressed, the fan speed mode is shifted.



Natural wind by the CHAOS logic

- For more fresh feeling than other fan speed, press the Indoor Fan Speed Selector and set to CHAOS mode. In this mode, the wind blows like natural breeze by automatically changing fan speed according to the CHAOS logic.



Jet Cool Operation

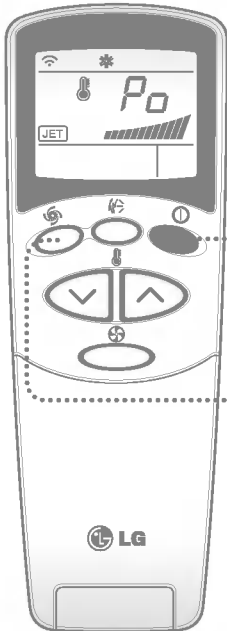

- 1 Press the Start/Stop button.
The unit will respond with a beep.

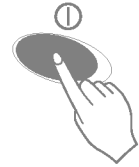

- 2 Press the **Jet Cool** button to operate the speed cooling mode and the unit will operate in super high fan speed on cooling mode for 30 minutes.



- 3 To cancel the **Jet Cool** mode, press the **Jet Cool** button or the fan speed button or the room temperature setting button again and the unit will operate in high fan speed on cooling mode.

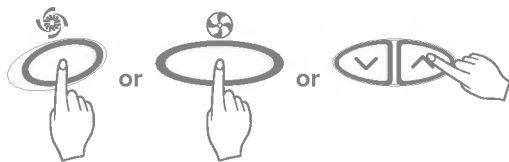

NOTE:

- During the JET COOL function at any moment, the A/C starts to blow the cool air at extremely high speed for 30 minutes setting the room temp. automatically to 18 °C. It is especially used to cool the room temp. in the shortest time in a hot summer.
In heat pump mode or neuro fuzzy mode, however, the JET COOL function is not available.
- In order to return to the normal cooling mode from the JET COOL mode, you just press either the operation mode selection button, airflow volume selection or temp. setting button or the JET COOL button again.



PLASMA Purification Operation(Optional)

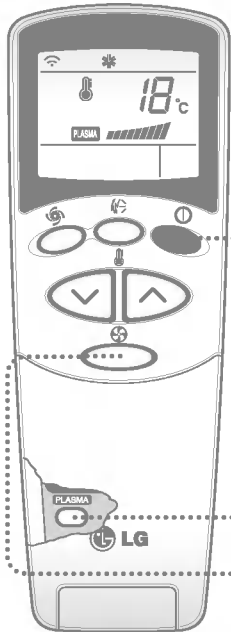

- 1 Press the Start/Stop button.
The unit will respond with a beep.



- 2 Open the door on the remote control.
Press the PLASMA air purifying operation ON/OFF button.
Operation will start when the button is pressed and stop when the button is pressed again.





- 3 Set the fan speed again with door of the remote control closed. You can select the fan speed in four steps-low, medium, high or CHAOS.
Each time the button is pressed, the fan speed mode is shifted.

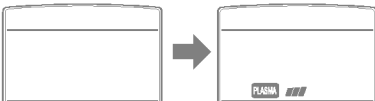

* Air purifying operation (PLASMA) can be with cooling, Heating or any other operations.

PLASMA Air Purifying Operation only



If you press the only PLASMA button, only PLASMA air purifying operates.
Then, fan speed is low. You can select the fan speed in four steps-low, medium, high or CHAOS.
Each time the button () is pressed, the fan speed mode is shifted.

2ndF 2nd F Operation

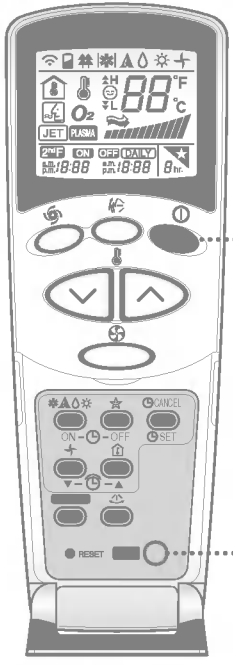

1 Press the Start/Stop button. The unit will respond with a beep.



2 Open the door of the remote control and press the 2nd Function button to operate functions printed in blue at bottom of buttons. (Check the indication of 2nd function on remote control display.)
These buttons operate the timer setting as follows:

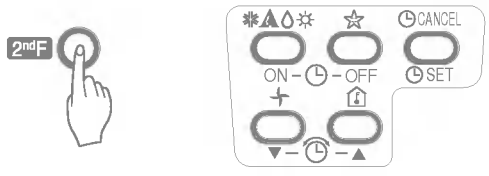

3 2nd function goes off in a short time automatically or when the button is pressed again.

For more details, refer to functions next page.

Additional features

★ Sleep Mode

- Press the Sleep Mode Auto button to set the time you want the unit to turn off automatically.
- The Timer is programmed in one-hour increments by pressing the Sleep Mode Auto button 1 to 7 times. The sleep mode is available for 1 to 7 times. To alter the time period in steps of 1 hour, press the Sleep Mode Button while aiming at air conditioner.
- Make sure the Sleep Mode Auto LED lights up.



To cancel the Sleep Mode, press the sleep Mode Auto button several times until the star (★) disappears from the operation display.

Note: The Sleep Mode will be operated at slow fan speed (cooling) or medium fan speed (heat pump only) for quiet sleeping.

IN COOLING MODE OR HEALTHY DEHUMIDIFICATION MODE:

The temperature will automatically rise by 1°C over the next 30 minutes and by 2°C in 1 hour for comfortable sleeping.

🕒 Setting the Time

- Time can be set only when you have pressed the Reset button. If you have just replaced the batteries, the Reset button should be pressed to reset the time.
- Press the Start/Stop button.
- Press 2nd F button and check if 2nd F icon is on.



- Press the Time Setting buttons until the desired time is set.



- Press the Timer SET button.



Note: Check the indicator for A.M. and P.M.

🕒 Delay Start/Pre-Set Stop

- Make sure the time is set correctly on the remote control display.
- Press 2nd F button.
- Press the ON/OFF Timer buttons to turn Timer on or off.
- Press the Time Setting buttons until the desired time is set.



- To set the selected time, press the Timer SET button while aiming the remote control at the signal receptor.



To cancel the timer setting

Check if 2nd F icon is off. Press the Timer Cancel button while aiming remote control at the signal receptor. (The timer lamp on the air conditioner and the display will go out.)



NOTE: Select one of the following four types of operation.

with the unit running



Delay OFF Timer



Delay ON Timer



Delay OFF and ON Timer



Delay ON and OFF Timer



Vertical Airflow Direction Control

The up/down airflow (Vertical Airflow) can be adjusted by using the remote control.

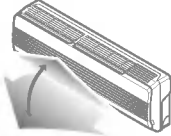

- Press the Start/Stop button to start the unit.
- Press Chaos Swing button and the louvers will swing up and down. Press the Chaos Swing button again to set the vertical louver at the desired airflow direction.



Note:

- If you press the CHAOS swing button, the horizontal airflow direction is changed automatically based on the CHAOS algorithm to distribute the air in the room evenly and at the same time to make the human body feel most comfortable, as if enjoying a natural breeze.
- Always use the remote control to adjust the up/down airflow direction. Manually moving the vertical airflow direction louver by hand, could damage the air conditioner.
- When the unit is shut off, the up/down airflow direction louver will close the air outlet vent of the system.

To adjust left/right(Horizontal Airflow) direction

- Caution :** Ensure that the unit is turned off before adjusting the horizontal airflow direction control. Carefully open vertical louver to allow access to the horizontal airflow direction.
- Adjust the left/right airflow direction by hand.

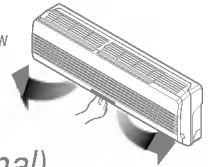

Horizontal Airflow Direction Control (Optional)

The left/right(Horizontal Airflow) can be adjusted by using the remote control. Press the Start/Stop button to start the unit.

Open the door on the remote control. Press the Airflow Direction Start/Stop button and the louvers will swing left and right. Press the Horizontal Airflow Direction Control Button again to set the horizontal louver at the desired airflow direction.

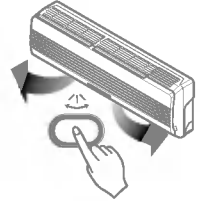

Air Circulation Mode

Circulates the room air without cooling or heating.

- Press the Start/Stop button. the unit will respond with a beep.
- Open the door on the remote control. Press the Air Circulation button. Close the door on the remote control. Now each time that you press the Indoor Fan Speed Selector, the fan speed is shifted from low to CHAOS and back to low again.

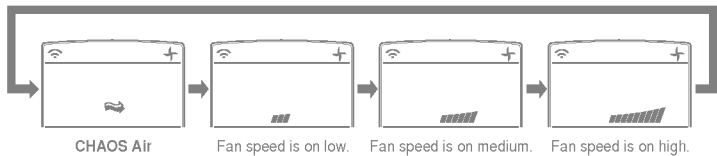

Note:

- **CHAOS Air** economizes power consumption and prevents overcooling. The fan speed is automatically changed from high to low or vice versa, depending on the ambient temperature.



Forced Operation

Operation procedures when the remote control can't be used.
The operation will be started if the power button is pressed.
If you want to stop operation, re-press the button.

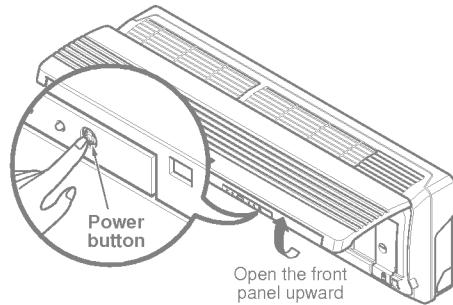

	Cooling Model	Heat pump Model		
		Room Temp. $\geq 24^{\circ}\text{C}$	$21^{\circ}\text{C} \leq$ Room Temp. $< 24^{\circ}\text{C}$	Room Temp. $< 21^{\circ}\text{C}$
Operating mode	Cooling	Cooling	Healthy Dehumidification	Heating
Indoor FAN Speed	High	High	High	High
Setting Temperature	22°C	22°C	23°C	24°C

Test operation

During the TEST OPERATION, the unit operates in cooling mode at high speed fan, regardless of room temperature and resets in 18 minutes.

During test operation, if remote controller signal is received, the unit operates as remote controller sets. If you want to use this operation, open the front panel upward and Press the power button let it be pressed for about 3 seconds.

If you want to stop the operation, re-press the button.

Auto restart

In case the power comes on again after a power failure, Auto Restarting Operation is the function to operate procedures automatically to the previous operating conditions.

So there is no need of activating this function by pressing any key or button.

In the initial mode, the fan operates at a low speed and the compressor starts 2.5~3 minutes later.

As the compressor starts, the fan speed also resumes its previous setting mode.

Helpful information

Fan speed and cooling capacity.

The cooling capacity indicated in the specification is the value when the fan speed is set to high, and the capacity will be lower at low or medium fan speed.

High fan speed is recommended when you wish to cool the room quickly.

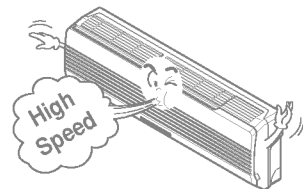



Telephone Control Operation(Optional)

Calling from outside, you can start the air conditioner to keep the room comfortable.
Even though you went out with the air conditioner on, you can turn it off using the phone outside.

TURN ON



- 1 Dial the number which is connected with the air conditioner.
 - 2 After ringing 5 times.
 - 3 You can hear the "Beep" sound (if the air conditioner is off), then press "0" "0" "7" "8" accordingly.
-
- 2 OGM guide is provided after signal sound rings four times and then "Beep"(sounds from telephone itself) sounds so that outside recording can be done.
 - 3 Slowly press password "0" "0" "7" and "8" in order.
- 4 With the sound "Beep, Beep" the air conditioner starts on.
 - 5 Hang up the phone.

TURN OFF



- 1 Dial the number which is connected with the air conditioner.
 - 2 After ringing 5 times.
 - 3 You can hear the "Beep Beep" sound (if the air conditioner is on), then press "0" "0" "7" "9" accordingly.
-
- 2 OGM guide is provided after signal sound rings four times and then "Beep"(sounds from telephone itself) sounds so that outside recording can be done.
 - 3 Slowly press password "0" "0" "7" and "9" in order.
- 4 With the sound "Beep---" the air conditioner is turned off.
 - 5 Hang up the phone.

Note:

- This product works after telephone rings 5 times.
- If internal user picks up the phone before 5 rings, Telephone control function does not work.
- If user doesn't push the telephone button 25 seconds after beep, Telephone control function doesn't work.

- The numbers of response bell should be adjusted to four times if pressing "Out-of-office" button or taking other action for automatic response.

- The recording time of OGM (Outgoing Message) should be less than approximately 15 seconds.

- If it is connected to key phone, it cannot be worked.

Care and maintenance of the air conditioner

CAUTION: Before performing any maintenance, turn off the main power to the system.

Indoor Unit

Grille, Case, and Remote Control

- Turn the system off before cleaning. To clean, wipe with a soft, dry cloth. Do not use bleach or abrasives.

NOTE:

Supply power must be disconnected before cleaning the indoor unit.

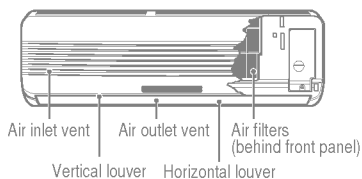

AIR FILTERS

The air filters behind the front grille should be checked and cleaned once in every 2 weeks or more often if necessary.

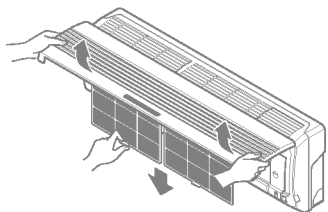

PLASMA FILTER, DEODORIZER FILTER(OPTIONAL)

The PLASMA filter behind the air filters should be checked and cleaned once in every 3 months or more often if necessary.

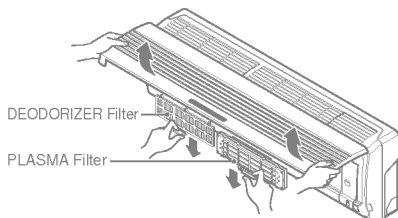

Don't touch this PLASMA Filter within 10 seconds after opening the inlet grille, it may cause an electric shock.

- Never use any of the followings:
 - Water hotter than 40 °C
Could cause deformation and/or discoloration.
 - Volatile substances
Could damage the surfaces of the air conditioner.



- Lift the front access panel and pull the filter tab slightly forward to remove the filter.
- Clean the filter with a vacuum cleaner or warm, soapy water.
 - If dirt is conspicuous, wash with a solution of detergent in lukewarm water.
 - If hot water (40 °C or more) is used, it may be deformed.
- After washing with water, dry well in the shade.
- Re-install the air filter.
- After removing the air filters, pull slightly forward to remove the PLASMA filter.
- Dip the PLASMA filter into the water mixed with neutral detergent, for 20~30 minutes.
- Dry the PLASMA filter in the shade for a day (Especially, the humidity must be removed perfectly on this parts).
- Note the cuts of electric discharge lines.
- Re-install the PLASMA filter to the original position.
- After removing the air filters, pull slightly forward to remove the DEODORIZER filter.
- Dry in the sunlight for two hours.
- Re-install the DEODORIZER filter to the original position.

Replacement of Purifying Filter(Optional)

- Recommended use period : About 2 years

- Open front panel and remove air filters.

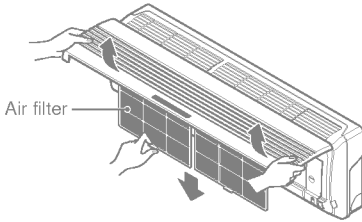

- Remove air purifying filters.

- Insert new air purifying filters.

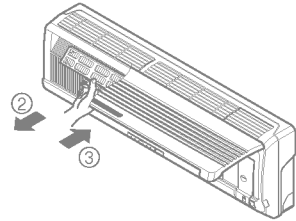

- Reinsert air filters and close front panel.

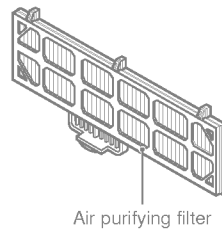
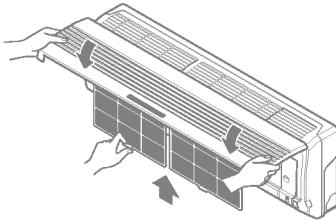

Outdoor Unit

The heat exchanger coils and panel vents of the outdoor unit should be checked regularly. If clogged with dirt or soot, the heat exchanger and panel vents may be professionally steam cleaned.

NOTE:

Dirty or dogged coils will reduce the operating efficiency of the system and cause higher operating costs

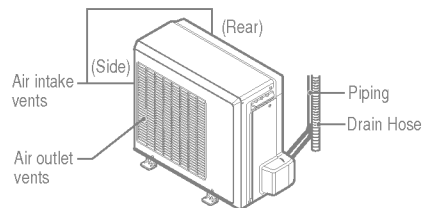
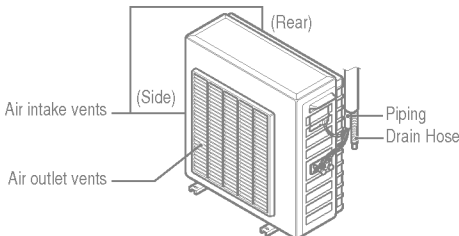
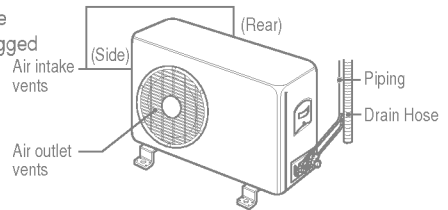

When the air conditioner is not going to be used for a long time.

1 Operate the air conditioner on Air circulation mode (Refer to page 14) for 2 to 3 hours.

- This will dry out the internal mechanisms.

2 Turn off the circuit breaker, and disconnect the plug.



CAUTION

Turn off the circuit breaker when the air conditioner is not going to be used for a long time.

Dirt may collect and may cause a fire.

3 Remove the batteries from the remote control.

1 Clean the air filter and install it in the indoor unit.
(Refer to page 17 for cleaning filters.)

2 Check that the air inlet and outlet of the indoor/outdoor unit are not blocked.

Operation Tips

This is not good for the health and wastes electricity.

Do not let direct sunshine enter the room when the air conditioner is in operation.

Adjust the vertical and horizontal airflow direction to ensure a uniform temperature in the room.

Avoid opening doors and windows as much as possible to keep the cool air in the room.

Blockages in the air filter reduces the airflow and lowers the cooling and dehumidifying effects. Clean at least once in every two weeks.

Since windows are kept closed, it is a good idea to open them and ventilate the room now and then.

Before you call for service...



Troubleshooting Tips! Save time and money!

Check the following points before requesting repairs or service.... If the fault persists, please contact your dealer or service center.

Case	Explanation	See page
The air conditioner does not operate.	• Have you made a mistake in timer operation?	13
	• Has the fuse blown or has the circuit breaker been tripped?	-
The room has a peculiar odor.	• Check that this is not a damp smell exuded by the walls, carpet, furniture, or cloth items in the room.	-
It seems that condensation is leaking from the air conditioner.	• Condensation occurs when the airflow from the air conditioner cools the warm room air.	-
Air conditioner does not operate for about 3 minutes when restarted.	• This is the protector of the mechanism. • Wait about three minutes and operation will begin.	-
Does not cool or heat effectively.	• Is the air filter dirty? See air filter cleaning instructions.	17
	• Has the temperature been set incorrectly?	6, 9
	• Are the indoor unit's air inlet or outlet vents obstructed?	-
The air conditioner operation is noisy.	• For a noise that sounds like water flowing. -This is the sound of freon flowing inside the air conditioner unit. • For a noise that sounds like the compressed air releasing into atmosphere. -This is the sound of the dehumidifying water being processed inside the air conditioning unit.	-
Remote control display is faint, or no display at all.	• Are the batteries depleted? • Are the batteries inserted in the opposite (+) and (-) directions?	4
Crack sound is heard.	• This sound is generated by the expansion/constriction of the front panel, etc. due to changes of temperature.	-