



MINI HI-FI AUDIO SYSTEM

OWNER'S MANUAL

**MODELS : FFH-2120A/AX/L/S/AD
FE-2120E
FFH-3130A/AX/L/S/AD
FE-3130E**

Please read this manual carefully before operating your unit.
Retain it for future reference.

Designs and specifications are subject to change
without notice for improvement.



3 **SAFETY INFORMATION**

4 **GETTING STARTED**

4 Controls and Connections

4 Front Panel

5 Rear Panel

6 Display

7 Remote Control

8 Remote Control Operation

8 Batteries

8 Using the Remote Control

9 Connections

9 Digital Outputs

9 Loudspeakers

10 Headphones

10 Antenna

10 Setting the Clock

11 Basic Operation

11 Auto Function Select System

11 Volume Adjustment

11 Tone Adjustments

11 Boost

11 EQ (Equalization)

11 Mute

11 Display Mode

11 Demo Mode

11 FM Stereo/ANR (AM Noise Reduction)

11 VMAx

12 **ENJOYING YOUR SYSTEM**

12 Listening to the Radio

12 Automatic Tuning

12 Manual Tuning

12 Programming Preset Stations

12 RDS (Radio Data System) Reception

13 Playing CDs

13 Basic Operation

13 Stopping Play

13 Pause

13 Skipping Discs

13 Direct Disc Access

13 Removing Discs

13 Changing Discs During Play

13 Important Notes

13 Searching Within a Track

13 Reverse Search

13 Forward Search

13 Track Skipping

13 Time Display

14 Repeating Tracks

14 Random Play

14 Programmed Play

14 Reviewing the Contents of the Play List

14 Clearing the Programmed Play List

14 Adding Tracks to a Previously Programmed Play List

14 Making Changes to the Play List

15 Using External (Auxiliary) Sources

15 Playing Tapes

15 Playback

15 Tape Counter

16 Recording Tapes

16 CD Sync Recording

16 Recording From Tape to Tape (Dubbing)

17 **ADVANCED FEATURES**

17 Dual Alarms and Timer Recording

17 Alarm and Timer Setting

17 To Cancel or Check the Timer

17 Alarm and Timer Notes

17 Setting the Sleep Timer

18 **TROUBLESHOOTING**

19 **SPECIFICATIONS**

Please read this manual carefully before operating your system, and retain it for future reference.

read first! Important Safety Precautions!

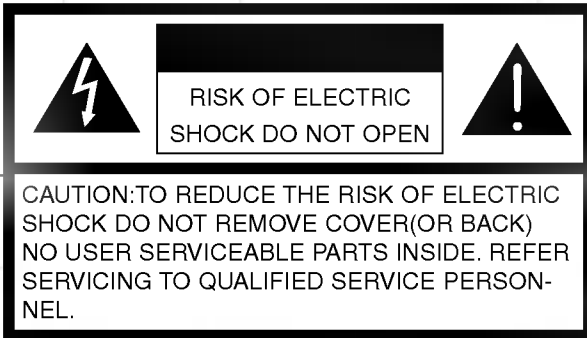

Explanation Graphical Symbols:



The lightning flash with arrowhead symbol, within an equilateral triangle is intended to alert the user to the presence of uninsulated dangerous voltage within the product's enclosure that may be of sufficient magnitude to constitute a risk of electric shock to persons.



The exclamation point within an equilateral triangle is intended to alert the user to the presence of important operating and maintenance (servicing) instructions in the literature accompanying the appliance.

WARNING

TO REDUCE THE RISK OF FIRE OF ELECTRIC SHOCK, DO NOT EXPOSE THIS APPLIANCE TO RAIN OR MOISTURE.

To avoid electrical shock, do not open the cabinet, Refer servicing to qualified personnel only.

The apparatus shall not be exposed to dripping or splashing and that no objects filled with liquids, such as vases, shall be placed on the apparatus.

Warning:

Do not install this equipment in a confined space such as a book case or similar unit.

CAUTION

Use of controls or adjustments or performance of procedures other than those specified herein may result in hazardous radiation exposure.

Laser component in this product is capable of emitting radiation exceeding the limit for Class 1.

CAUTION: INVISIBLE LASER RADIATION WHEN OPEN AND INTERLOCKS DEFEATED. AVOID EXPOSURE TO BEAM.

VARNING: OSYNLIG LASERSTRÅLNING NÄR DENNA DEL ÄR ÖPPNAD STRÅLEN ÄR FARLIG.

Attention: Quand l'appareil est ouvert, ne pas s'exposer aux radiations invisibles du faisceau laser.

This label is located on the interior.

CLASS 1	LASER PRODUCT
KLASSE 1	LASER PRODUKT
LUOKAN 1	LASER LAITE
KLASS 1	LASER APPARAT
CLASSE 1	PRODUIT LASER

This Compact Disc player is classified as a CLASS 1 LASER product.

The CLASS 1 LASER PRODUCT label is located on the exterior.

This product is manufactured to comply with the radio interference requirements of EEC DIRECTIVE 89/336/EEC, 93/68/EEC and 73/23/EEC.

GETTING STARTED

Controls and Connections

Front Panel

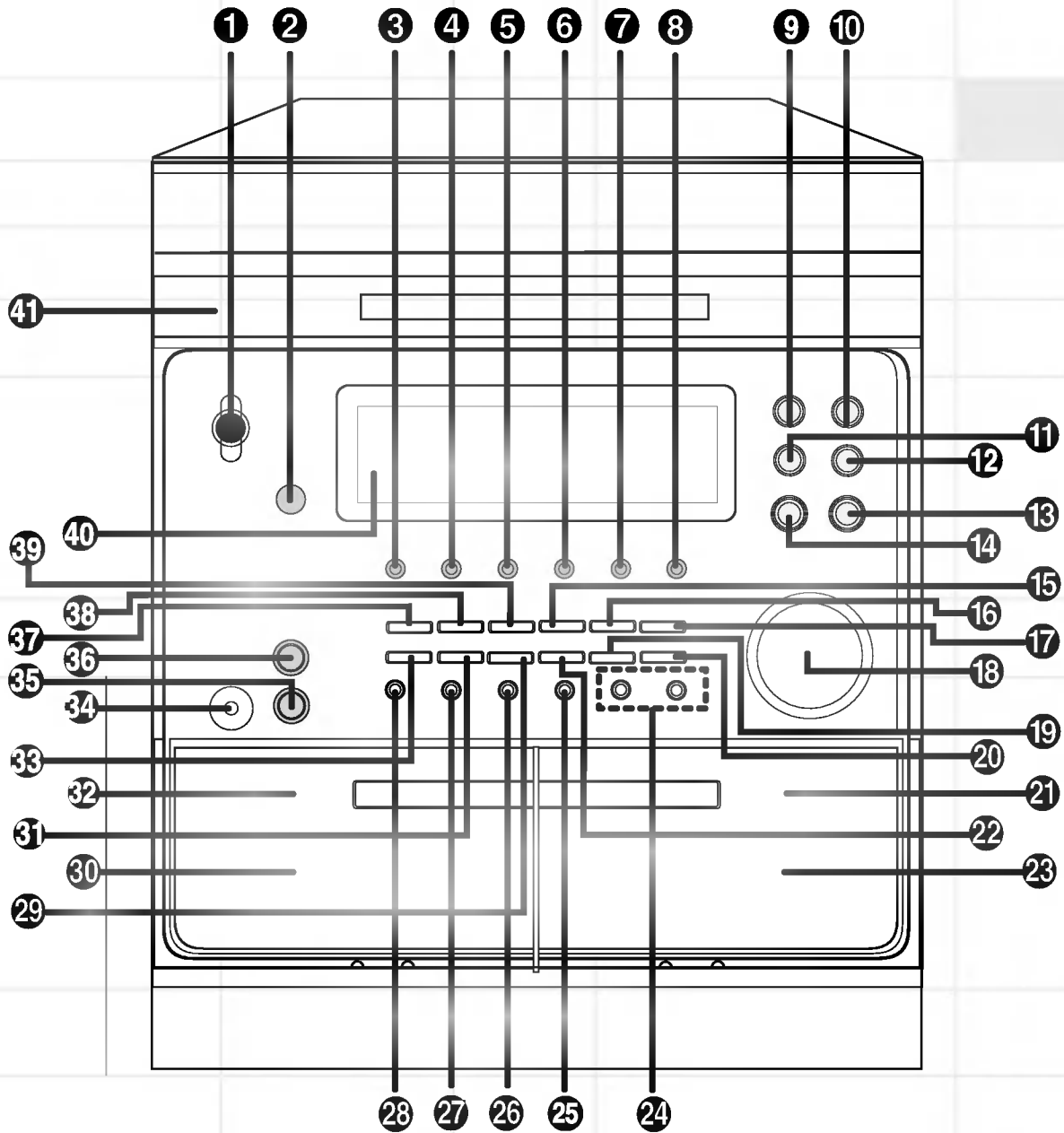

- ❶ Power button
- ❷ Remote Sensor
- ❸ Set button
- ❹ CD Sync (CD Synchro Dubbing) button
- ❺ Disc 1 button: Disc Direct Play button
- ❻ Disc 2 button: Disc Direct Play button
- ❼ Disc 3 button: Disc Direct Play button

- ❽ Disc Skip button
- ❾ Tuner/Band (AM/FM) button
- ❿ Tape A/B Select button
- ⓫ Aux button
- CD Function button
- ⓬ CD Tray Open/Close button
- ⓭ \blacklozenge VMAx button

- ⓮ Time button
- ⓯ FM Stereo/ANR (AM Noise Reduction) button
- ⓰ Clock button
- ⓱ Volume knob
- ⓲ Alarm 1 button
- ⓳ Alarm 2 button

GETTING STARTED

Controls and Connections

- 21 Tape Deck B Eject
- 22 CD Pause button
- 23 Tape Deck B (Rec/Play) Door
- 24 TUNING ▼/▲(AM/FM),
Fast Forward/Rewind (Tape),
Skip/Search (CD) button
- 25 PRESET ▷/Forward Play (Tape)/
Play (CD) button
- 26 PRESET ◁
Reverse Play (Tape) button

- 27 Stop/Reset
(Tape, CD, Tuner Presets) button
- 28 Record/Pause (Tape) button
- 29 Counter Reset button
- 30 Tape Deck A (Play) Door
- HIGH Speed (Tape to Tape)
Dubbing button
- Tape Deck A Eject
- Normal Speed (Tape to Tape)
Dubbing button

- Headphones jack
- Boost button
- EQ Select button
- CD/Tuner Program button
- Play Mode/Demo button
- Random button
- Display
- CD Tray

Rear Panel

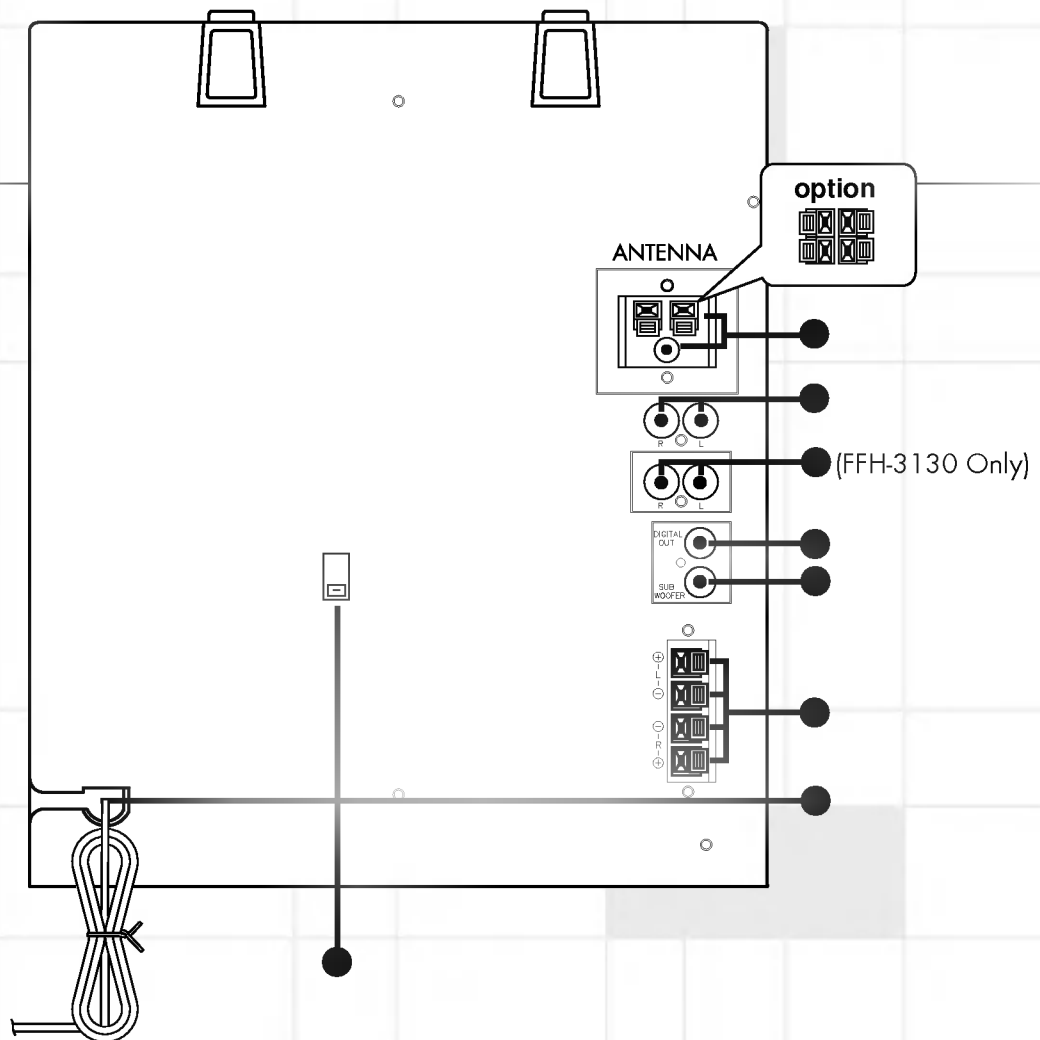

- Antenna terminals
- Aux 2 Input jacks
- Tweeter/Midrange Speaker Output
jacks (Model FFH-3130 only)

- Coaxial Digital Output jack
- Subwoofer Output jack
- Speaker Terminals (Model FFH-2120)/
Speaker Woofer Section terminals
(Model FFH-3130)

- Power Cord
- Voltage Selector
(Optional)

GETTING STARTED

Controls and Connections

Display

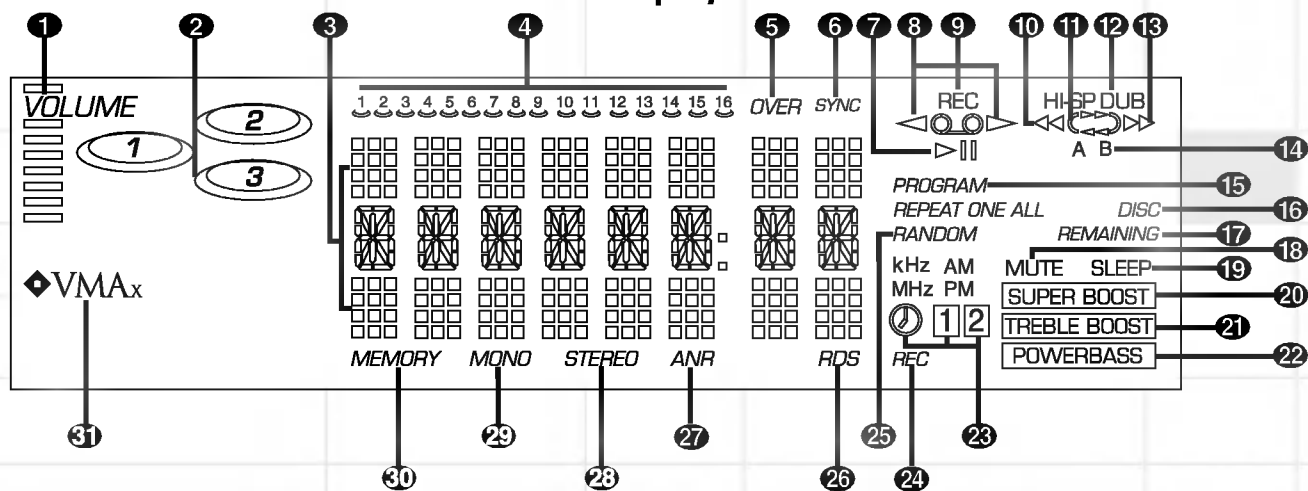

- 1 Volume Level
- 2 Disc Number indicators
- 3 Information Display for Level, Function, Clock, Frequency, Tape Counter, CD Time, Programmed Play List
- 4 CD Track Numbers Remaining
- 5 CD Play Over indicator
- 6 CD Sync Recording indicator
- 7 CD Play/Pause indicator
- 8 Tape Direction indicators
- 9 Record indicator

- 10 Rewind indicator
- 11 Play Mode indicators (Used only for Deck B)
- 12 Hi-Speed Dubbing indicator
- 13 Fast Forward indicator
- 14 Tape A/B indicator
- 15 CD Program indicator
- 16 CD Repeat indicators
- 17 CD Remaining Time indicator
- 18 Mute indicator
- 19 Sleep indicator
- 20 Super Boost indicator

- 21 Treble Boost indicator
- 22 PowerBass™ indicator
- 23 Alarm 1/2 indicator
- 24 Timer Recording indicator
- 25 CD Random Play indicator
- 26 RDS indicator-optional
- 27 ANR (AM Noise Reduction) indicator
- FM Stereo indicator
- FM Mono indicator
- Memory indicator
- VMAx® indicator

GETTING STARTED

Controls and Connections

Remote Control

- 1** Power button
- 2** Mute button
- 3** Tuner/Band button
- 4** Tuner Preset ▼/▲ buttons
- 5** Aux 1/2 button

Tape Functions

- 6** Stop button ■
- 7** Forward Play button ▶
- 8** Record/Record Pause button ● ||
- 9** Fast Forward button ▶▶
- 10** Tape A button
- 11** Tape B button
- 12** Reverse Play button ◀
- 13** Rewind button ◀◀

CD/Tuner Functions

- 14** Sleep button
- 15** Repeat button
- 16** Play/Pause button ▶||
- 17** Reverse Skip or Search (CD)/
Tune Down button ◀◀◀◀
- 18** Stop/Clear button ■
- 19** Forward Skip or Search (CD)/
Tune Up button ▶▶▶▶
- 20** Program (CD) button
- 21** Disc Skip button (CD)

- 22** Display Mode button
- 23** VMAx button
- 24** EQ Select button
- 25** Boost Select button
- 26** Volume Control ▲/▼ buttons

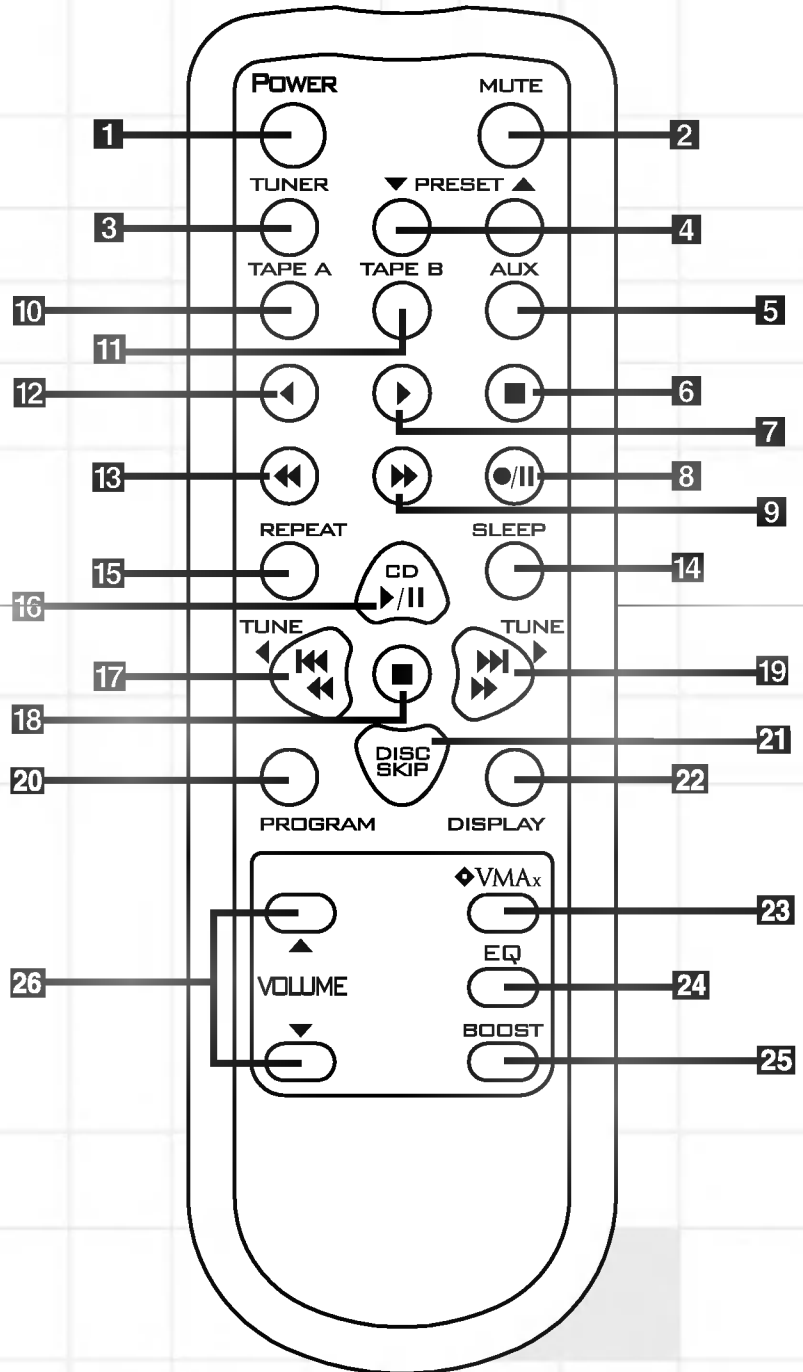

GETTING STARTED

Remote Control Operation

Batteries

Before using the remote control for the first time, insert two AAA (UM-4, IEC R03)-type high-quality batteries, as shown in the diagrams below. Be sure to observe correct battery polarity (+ and -), as installing the batteries incorrectly may damage the remote. Do not use different types of batteries together, and do not mix old ones with new ones.

Open the battery cover

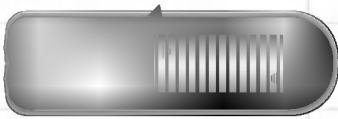

Insert two AAA batteries

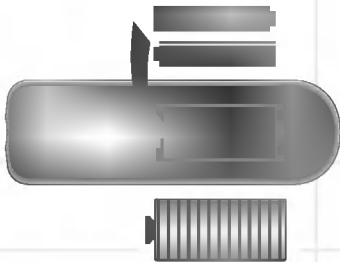

- When you are not going to use your System for an extended period of time, such as when you go on vacation, remove the batteries to prevent possible electrolyte leakage.
- After a period of time, when the remote control fails to operate accurately at maximum distance from the unit (23 feet, or 7 meters), replace the dead batteries with new ones.

Using the Remote Control

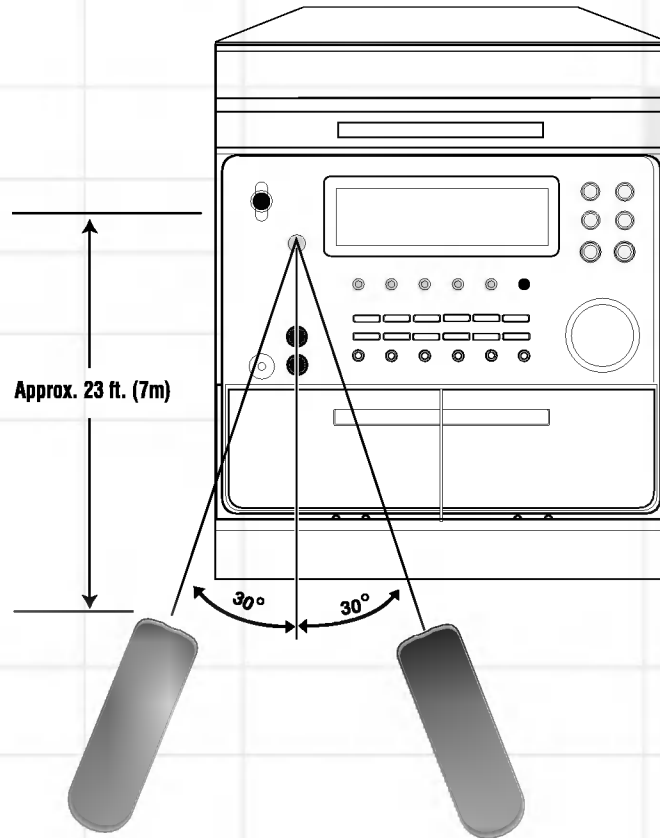

Control Range

The remote control device is designed for a maximum range of 23 feet (7 meters).

NOTE:

Strong light or obstacles between the remote control device and the main unit may interfere with the operation of the remote control.

GETTING STARTED

Connections

Digital Outputs

A rear panel **Coaxial** ● **Digital Output** are provided. The rear Coaxial Output should be used for more permanent hookups, such as a CD recorder, MD recorder, high-end computer sound card with digital inputs or MP3 encoder. Coaxial cables are not supplied with this product and, if not included with the connecting unit, should be purchased separately.

Loudspeakers

Be sure to turn **Power** 1 1 off before connecting the loudspeakers.

In these instructions, the "right speaker" and "left speaker" refer to the speakers as viewed from the listening position.

Speakers and electronics have corresponding (+) and (-) terminals. LG has used red to denote the (+) terminal and speaker wire, and black for the (-) terminal and speaker wire. It is important to connect both speakers identically: (+) on the speaker to (+) on the main unit, and (-) on the speaker to (-) on the main unit. Wiring "out of phase" results in thin sound, weak bass and a poor stereo image.

(FFH-2120)

Insert the bare end of the red (+) wire of the right speaker into the red (+) terminal on the main unit that is marked R ●. Insert the bare end of the black (-) wire of the right speaker into the black (-) terminal on the main unit that is marked R ●. Follow the same procedure to connect the wires from the left speaker to the terminals on the main unit that are marked L ●.

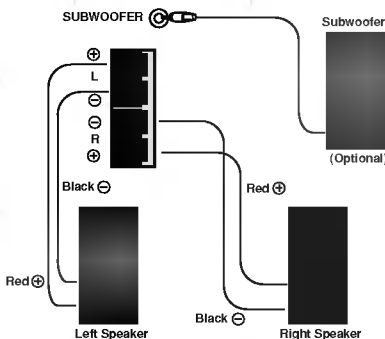

Figure 1

(FFH-3130)

In order to provide superior definition and clarity, the FE-3130E speakers use a different method of connection for the tweeter and midrange sections. For proper performance, be sure to connect all three wires from each speaker as described below:

Insert the yellow RCA-type plug from the right speaker into the yellow jack on the back of the main unit that is marked R ● (Speaker Connector 1 in Figure 3).

Note: Never insert the yellow plugs into any equipment other than the main unit or you may cause damage to the speakers that is not covered by your warranty.

Never insert any plugs other than the yellow plugs attached to loudspeakers into the yellow jacks on the main unit ● or you will cause damage that is not covered by your warranty.

Insert the bare end of the red (+) wire of the right speaker into the red (+) terminal on the main unit that is marked R ●. Insert the bare end of the black (-) wire of the right speaker into the black (-) terminal on the main unit that is marked R ●. Follow the same procedure to connect the wires on the left speaker to the jack and terminals on the back of the main unit that are marked L ● ●.

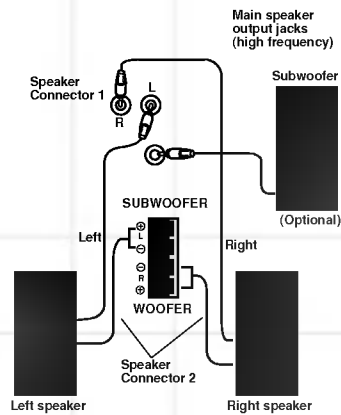

Figure 2

Using Your System With an External Powered Subwoofer

The FFH-2120 and FFH-3130 both feature a **Subwoofer Output** jack ● that can be used with any unit powered subwoofer recommended by your unit dealer. The addition of a powered subwoofer dramatically extends and improves your system's bass response, and is highly recommended either at the time of initial purchase or as a future upgrade. Using a single RCA cable (not included), connect the subwoofer output to the L or R input of the powered subwoofer (the use of a Y-cable is not necessary but is OK). Set the main unit to a normal listening level, and adjust the level, frequency and phase controls on the powered subwoofer as directed in the subwoofer's owner's manual.

GETTING STARTED

Connections (cont.) Headphones

Connecting a headphone ● automatically disables the loudspeakers in order to provide a private listening session.

Antenna

Important

FM Antenna Connection

Unless radio signals are very weak, no external antenna is necessary. Simply connect the supplied FM indoor antenna wire to the terminal marked FM on the back of the unit ●.

AM Antenna Connection

Connect the supplied AM loop antenna to the terminal marked AM on the back of the unit ●.

For the models for other countries figure (1), (2).
For the European and U.K. model figure (3), (4).

(1) 2 BAND(FM/AM) AREA

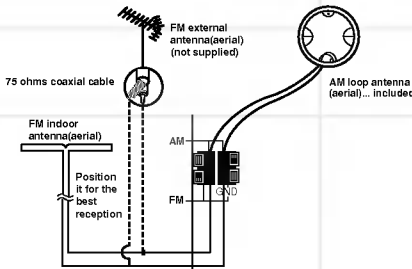

(2) 3 BAND(FM/MW/SW) AREA

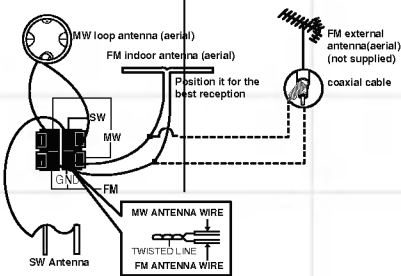

(3) 3 BAND(FM/MW/LW) AREA

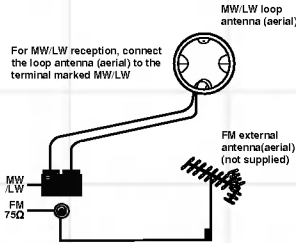

(4) 2 BAND(FM/AM(MW)) AREA

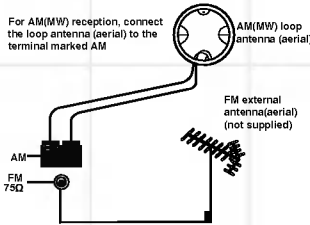

Setting the Clock

Setting the clock will be demonstrated with the example of 9:25 AM.

Although unit will retain the clock setting when you power it down into the Standby mode, the setting will be lost if the unit is unplugged or the electrical power is interrupted for more than 10 seconds. In that event, the clock setting will be erased, and the unit will display a blinking " — : — ".

When setting the time, remember that midnight is at 12:00 AM and noon is at 12:00 PM.

1. Press the **Clock** button ⑰. (If the clock was previously set, press and hold the Clock button for more than 1.5 seconds.)

"12:00 AM" will blink in the **Display** ●, to indicate civilian 12-hour time. Press the **Presets** > ⑳ or **Presets** < ㉑ button to display a blinking "0:00", which denotes 24-hour military time.



2. Choose between the 24-hour display or 12-hour display by pressing the **Presets** > ㉑ or the **Presets** < ㉑ buttons.

3. Press the **SET** button ③ to store this setting and proceed to the next step.



4. Set the hour by pressing the **Presets** > ㉑ or the **Presets** < ㉑ buttons.

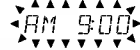

5. Press the **SET** button ③.



6. Set the minute by pressing the **Presets** > ㉑ or the **Presets** < ㉑ buttons.



7. Press the **SET** button ③, and the clock will resume normal operation.

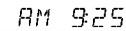

GETTING STARTED

Basic Operation

Auto Function Select System

This system allows you to automatically switch sources by selecting a function associated with the new source in a single step, without having to press an input or source select button. That is, if, for example, the radio is playing and you wish to switch to playing a CD, you need only press the **Disc 1** button **5**, and the unit will automatically switch to CD mode, where the various function buttons will affect the CD changer rather than the tuner. (You can open the disc tray to change discs without affecting the tuner operation.) This applies for the following sources and functions:

- Using the remote control
Tuner: **Preset** ▲/▼ buttons **4**
CD: **Play/Pause** ►|| button **16**
Tape: **Forward** ◀ and **Reverse** ▶ **Play** buttons **7**/**12**
- On the unit
CD: **Disc Direct Play** buttons (DISC 1, 2, 3) **6**/**6**/**7**

Volume Adjustment

Turn the **Volume** knob **13** clockwise to increase the sound level, or counterclockwise to decrease it. If you turn the volume up above the maximum level, the volume level flashes in the display. This is a warning to lower the volume in order to prevent possible damage to your loudspeakers. You may also adjust the volume by pressing the **Volume Up or Down** buttons **26** on the remote control.

Sound can be deceiving. Over time your hearing "comfort level" adapts to higher volumes of sound. What sounds "normal" can actually be loud and harmful to your hearing. Guard against this by choosing a safe level BEFORE your hearing adapts.

To Establish a Safe Level:

- Start your volume control at a low setting.
- Slowly increase the sound until you can hear it comfortably, clearly and without distortion.

Once You Have Established a Comfortable Sound Level:

- Do not exceed that level.

Taking a moment to do this now will help to prevent hearing damage or loss in the future. After all, we want you listening for a lifetime.

Tone Adjustments

Boost

Each time the **Boost** button **1** is pressed, the tone changes as follows:

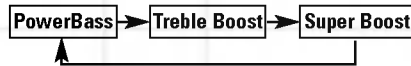

- **PowerBass**: Reinforces low frequencies
- **Treble Boost**: Reinforces high frequencies
- **Super Boost**: Reinforces both bass and treble

EQ (Equalization)

Press the **EQ** button **2** once to display the current sound mode.

Press the **EQ** button **2** repeatedly until the desired sound mode is displayed.

- **POP**: Optimized for Top 40, R & B, Soul and Country music
- **ROCK**: Optimized for Hard Rock and Heavy Metal music
- **FLAT**: No additional equalization
- **JAZZ**: Optimized for jazz music
- **CLASSIC**: Optimized for orchestral music

Mute

(On Remote Control)

Press the **Mute** button **2** to mute your unit. The Mute function silences the unit, which is convenient for answering the telephone, etc. The **Mute** indicator **13** will appear on the display. Press the **Mute** button **2** a second time to resume normal play.

Display Mode

(On Remote Control)

For your visual enjoyment, your system offers a spectrum lighting display that "dances" in time to the music. You can select different displays by repeatedly pressing the **Display Mode** button **22**, or you may turn the lighting display off.

Demo Mode

With the unit plugged in but turned off, press the **Play Mode/Demo** button **1** for a continuous visual display of the system's features. Press it again to return to a display of the current time.

FM Stereo/ANR (AM Noise Reduction)

When the FM radio signal is too weak to be received in Stereo mode without interference, press the **FM Stereo/ANR** button **16** to switch to Mono mode for improved reception. When recording AM radio transmissions, press this button to reduce unwanted noise.

VMaX®

VMaX is proprietary technology that creates an ambient, simulated surround-sound stage from a stereo signal or Dolby® Pro Logic®-encoded material using only two loudspeakers. It can be used with music and movies to create a more enveloping sound. Press the **VMaX** button on either the main unit **14** or the remote **23** to activate or deactivate the VMaX mode. The VMaX indicator on the display **1** will be lit when VMaX is active. In order to maximize the effect, the listener should be approximately 3m in front of the imaginary line between the two speakers, facing the speakers. The speakers should be facing the same direction, and should be placed even with each other. If used in a video application, the speakers should be to the right and the left of the screen, following all the other guidelines above. Please note that speakers are not shielded, and if placed too close to the screen may cause interference and degradation of the picture.

Speaker Placement

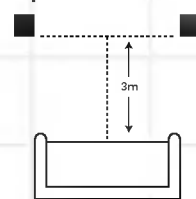

Speaker Placement in a Video Application

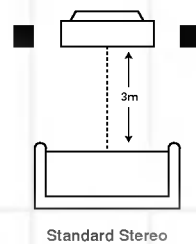

Standard Stereo



VMaX Virtual Surround

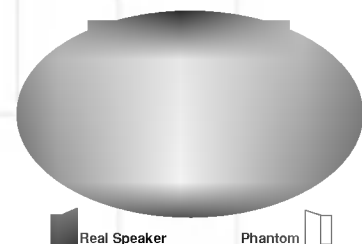

ENJOYING YOUR SYSTEM

Listening to the Radio

Automatic Tuning

1. Turn on the **Power** **1** **1**.
2. Press the **Tuner/Band** button **9** **3** repeatedly to choose either AM or FM (or SW, LW : optional) radio.
3. Press and hold the **TUNING** **▼/▲** (Tune **▼**/Tune **▲**) button **2** **1** **7** **1** **9** for more than 0.5 seconds. The unit will scan and automatically tune in a station of acceptable broadcast strength.

Manual Tuning

1. Turn on the **Power** **1** **1**.
2. Press the **Tuner/Band** button **9** **3** repeatedly to choose either AM or FM (or SW, LW : optional) radio.
3. Press the **TUNING** **▼/▲** (Tune **▲**/Tune **▼**) button **2** **1** **7** **1** **9** briefly and repeatedly, until the desired station is tuned.

Programming Preset Stations

To Clear All Presets From Memory:

1. While in Tuner mode (that is, the tuner was selected by pressing the **Tuner/Band** button **9** **3**), press and hold the **CD/Tuner Program** button **2** **0** for more than 1.5 seconds so that **RESET** flashes in the display. The **Memory** indicator **●** will appear in the display.
2. While **RESET** is flashing in the display, press the **Stop/Reset** button **2** **1** **8**.

Entering a Station Preset Into Memory:

1. Press the **Tuner/Band** button **9** **3** to select either the AM or FM band.
2. Press the **Tune** **▼/Tune** **▲** buttons **2** **1** **7** **1** **9** to tune in the desired station.
3. To store the station at the next available Preset number, press the **CD/Tuner Program** button **2** **0** TWICE. The first press causes the preset number to flash **3**, and the **Memory** indicator **●** to appear in the display. The second press stores the station to that preset number.
4. Alternatively, to store the station at a particular preset number of your choice, press the **CD/Tuner Program** button **2** **0** ONCE, so that the next available preset number flashes in the display. Press the **Preset** **▲/▼** buttons **2** **5** **2** **6** **4** to choose a preset number, then press the **CD/Tuner Program** button **2** **0** again, while the preset number is flashing, to store the station at that preset.

Tuning in Preset Stations:

Press and hold the **Preset** **▲/▼** buttons **2** **5** **2** **6** **4** until the desired preset number appears, or press the buttons repeatedly.

RDS (Radio Data System) Reception - OPTIONAL

What is RDS?

RDS (Radio Data System) is a system gradually being introduced on FM in many countries, whereby an inaudible stream of data is transmitted in addition to the normal radio signal. The data appears as text in the front panel **Information Display** **3**. This data can contain various types of information, including station identification, traffic and weather information and a list of alternative frequencies for the radio station being received.

1. Press the **Tuner/Band** button **9** **3** to select FM. RDS is not available on the AM band.
2. Tune in the desired station as described above.
3. When an RDS transmission is received, the display shows the station name and the **RDS** indicator **2** **6** lights.
4. To return to a display of the station frequency, press the **SET** button **3**.

Notes:

- RDS is only available for FM Reception.
- The station name is displayed automatically when an RDS station is received. However, if the signal is not strong enough, it may be possible to receive the audio signal without any RDS data.
- When an RDS station is first tuned in, the station name or other RDS information may be garbled for a few seconds while unit processes the signal. This is normal, and the correct information will appear automatically within a few seconds.

ENJOYING YOUR SYSTEM

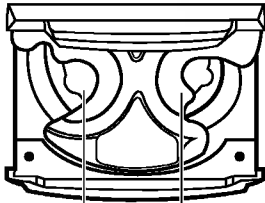

Playing CDs

Your system will play discs displaying the Compact Disc Digital Audio logo . It will also play properly finalized CD-R discs. The unit is not able to play CD-RW, DVD, Video CD, computer data discs, or any other type of disc except CD or CD-R, as noted above.



Tray for Disc 1 Tray for Disc 2

Basic Operation

1. Press the **CD Function** button .
2. Press the **CD Open/Close** button  to open the disc compartment.
3. Load up to three discs with the label side up. Each tray is numbered 1, 2 or 3 going counterclockwise around the carousel:



Playing one or two discs

Place discs on trays 1 and 2.

Playing three discs



After placing two discs, press the **Disc Skip** button  to rotate the carousel. Place the next disc in tray 3.

To load a 3-in. (8cm) disc, put it in the inner depression of the tray. Never place more than one disc at a time in any of the three tray positions.

4. Press the **CD Open/Close** button  to close the disc compartment.
5. Press the **Play** (or **▶▶▶** on remote control) button  to start play.

Play begins with the disc located on the left-hand side of the carousel just before closing the disc compartment, and proceeds counterclockwise around the carousel (in number order). All discs are played once only.

During playback, empty trays are skipped, and the unit proceeds counterclockwise to the next tray. The numbered indicator of any skipped tray will go out in the display .



The total number of audio tracks available on the disc being played will be displayed at the top of the display . As each track finishes playing, its corresponding number will go out. When a disc has more than 16 tracks, the "OVER" indicator  will light, and the track number will appear only in the **Information Display** .

Stopping Play

Press the **Stop/Reset** button .



Pause

Press the **CD Pause**  button .



To resume play, press the **CD Pause**  button  again, or press the **Play** button .

Skipping Discs



During play or in the Stop mode, press the **Disc Skip** button  to proceed to the next disc in order.

If the **Disc Skip** button  is pressed while a disc is playing, this unit will skip to the next disc and start playing it. However, if the **Disc Skip** button  is pressed while the unit is stopped, it will rotate the disc tray to the next disc, but it will NOT start playing.

Direct Disc Access

Press one of the **Disc Direct (Disc 1, 2 or 3)** buttons    to start playing the disc in that tray. After it plays through that disc, unit will continue to the next disc in order.

Removing Discs

Press the **CD Open/Close** button  to open the disc compartment. You can remove two discs at a time. To remove the disc in the back tray, press the **Disc Skip** button  to rotate the disc carousel.

Changing Discs During Play

The unit allows you to exchange two of the discs in the carousel while the third disc is playing. Simply open the disc compartment during play by pressing the **CD Open/Close** button , and remove or insert discs as described above. The disc located on the left side will be the next disc to be played after you close the disc compartment. This operation is not available during programmed play.

Important Notes

Do not tilt or move the unit with discs loaded. This may dislodge the discs. Usage under these conditions may damage the discs or the unit.

- Do not place more than one compact disc in one disc tray at the same time.
- If, during CD play, the video image of a nearby television is distorted, or if static is heard from a nearby radio, move this unit further away from the affected device.



Searching Within a Track

You can search for a particular point in a track during play by monitoring the high-speed cueing sound, or by observing the CD counter in the display .



Reverse Search



Press and hold the **Reverse Search**  button  and release it at the desired point.

Forward Search

Press and hold the **Forward Search**  button  and release it at the desired point.

Track Skipping



To return to the beginning of the current track, tap the **Reverse Search**  button  once.

To skip track(s) backward one by one, tap the **Reverse Search**  button  repeatedly.

To skip track(s) forward one by one, tap the **Forward Search**  button  repeatedly.

REMEMBER – TAP the button  to CHANGE tracks; but PRESS and HOLD the  button  to search WITHIN a track.

Time Display

Press the **Time** button  to show the time remaining on the current disc . Press it again to return to a display of the time elapsed .

ENJOYING YOUR SYSTEM

Playing CDs

Basic Operation (cont.) Repeating Tracks

The Repeat function is only available using the remote control, and cannot be accessed from the front panel buttons.

Once Repeat play has been selected, the player will continue to repeat the selection until you cancel it by pressing the **Repeat** button **15** once, so that the **Repeat** indicator **16** in the display goes out.

Repeat play may be selected either during play or in the Stop mode. If a programmed play list is playing, you may select either one track to repeat, or all discs to repeat the entire play list.

Repeat One Track

Press the **Repeat** button **15** ONCE to display **Repeat One** **16**, and press the **Play** (or **▶▶** on remote control) button **25/16** to start play.

Repeat One Disc

Press the **Repeat** button **15** TWICE to display **Repeat One Disc** **16**, and press the **Play** (or **▶▶** on remote control) button **25/16** to start play.

Repeat All Tracks on All Discs

Press the **Repeat** button **15** THREE times to display **Repeat All Disc** **16**, and press the **Play** (or **▶▶** on remote control) button **25/16** to start play.

Repeat Only Selected Tracks

Program the desired tracks as described in the next section, and press the **Repeat** button **15** while in Programming mode to display **Repeat One** or **Repeat All Disc** **16**.

If you program a play list during Repeat Play of an entire disc, the display will change to **Repeat All Disc** **16**.

Random Play

Press the **Random** button **25** before or during play, and the unit will play the tracks on the selected disc in random order. The **Random** indicator **25** will light in the display. To return to normal play, press the **Random** button **25** again.

If you tap the **Forward Search** button **24/19**, the unit will randomly select a new track. If you tap the **Reverse Search** button **24/17** once, it will go to the beginning of the current track. Tap the **Reverse Search** button **24/17** again, and the unit will randomly select a new track.

Programmed Play

You may program a play list of up to 20 tracks anywhere on up to 3 discs.

1. While in Stop mode, press the **CD/Tuner Program** button **20**.
2. Press one of the **Disc Selector** buttons **5/6/7** or the **Disc Skip** button **8/21** to select a disc. If the correct disc is already in position, then press the **CD Skip/Search** **1/2/3/4** buttons once to select the disc so that it appears in the display **3**.
3. Use the **CD Skip/Search** **1/2/3/4** or **▶▶▶▶** **24/19** buttons to select the desired track. For example, to select Track 6, press the **CD Skip/Search** **1/2/3/4** or **▶▶▶▶** **24/19** buttons repeatedly until track number "06" is displayed **3**.
4. Press the **CD/Tuner Program** button **20** to store the track in the play list.
5. Repeat Steps 2 through 4 to program up to 20 tracks into your play list. If you previously selected the correct disc, you do not need to repeat Step 2 in order to program additional tracks into your play list.
6. Press the **Play** **25/16** button (or **▶▶** on remote control) to start play.
7. If you stop play in the middle of the play list so that the program does not appear in the display, the play list will remain stored in memory, but the next press of the **Play** button **25/16** will cause the entire current disc to play. To resume playing the programmed play list, press the **CD/Tuner Program** button **20**, which will bring the program back to the display **3/15**.
8. If you program several tracks on the same disc out of order, e.g., Track 8 before Track 7, JBL Soundgear will play the tracks back in the programmed order, even though the **Track Number Display** **4** lists the programmed tracks in numbered order.
9. The **Disc Skip** **8/21** button does not operate during programmed play.
10. Random play cannot be selected while a programmed play list is playing.

Reviewing the Contents of the Play List

While in Stop mode, press the **CD/Tuner Program** button **20** to display the disc number, track number, and program number. Continue to press the **CD/Tuner Program** button **20** to step through the entire play list.

Clearing the Programmed Play List

There are three different ways to clear a previously programmed play list:

- While in Stop mode, press the **CD/Tuner Program** button **20**, and then press the **Stop/Reset** button **27/18**.
- Turn off the **Power** **1/1**.
- Press the **CD Open/Close** button **13**.

Adding Tracks to a Previously Programmed Play List

1. Press the **CD/Tuner Program** button **20** repeatedly to step through the play list until "00" is displayed as the track number **3**.
2. Select the desired track on the desired disc by pressing the **Disc Direct** buttons **5/6/7** or **Disc Skip** button **8/21** as necessary, and then by pressing the **CD Skip/Search** **1/2/3/4** or **▶▶▶▶** **24/19** buttons to proceed to the correct track.
3. Press the **CD/Tuner Program** button **20**.

Making Changes to the Play List

1. Press the **CD/Tuner Program** button **20** repeatedly until the disc and track number of the selected step is displayed **3**. This track will be replaced in the play list by the new track you are about to program.
2. Select the desired track on the desired disc by pressing the **Disc Direct** buttons **5/6/7** or **Disc Skip** button **8/21** as necessary, and then by pressing the **CD Skip/Search** **1/2/3/4** or **▶▶▶▶** **24/19** buttons to proceed to the correct track.
3. Press the **CD/Tuner Program** button **20**.

It is not possible to delete a single step from the programmed play list.

ENJOYING YOUR SYSTEM

Using External (Auxiliary) Sources

1. Switch on the auxiliary device (TV, VCR or MP3 player) connected to the rear **AUX** jack.
2. press **Aux** button **15**.
3. See the Recording section on page 16 for information on tape recording from an auxiliary source.

Playing Tapes

Playback

This system can only use normal bias tapes. It is equipped with two cassette decks, "A" and "B". Deck A is used only for playback, and will stop at the end of each side of the tape. Deck B may be used for either playback or recording, and includes an auto reverse capability which can be controlled with the **Play Mode** button **11**.

1. Switch the unit on **11**.
2. Open either cassette deck A or B by pressing gently on the door at the **Eject** position **21** **11**. Insert the cassette with the tape side to the bottom and the side that you wish to hear facing the front. Gently push the door to close it.
3. Press the **Tape A/B** button **10** **10** **11**. If necessary, press the button again to select the other deck. This unit will display which deck has been selected **3** **14**. The unit will not select a deck that does not have a tape loaded.
4. Auto reverse (for Deck B only): Press the **Play Mode** button **11** repeatedly to select:
 - One side **22** : Unit plays the side that is facing the listener and stops automatically at the end of that side.
 - All sides **23** : Unit plays the front and reverse sides and stops automatically at the end of the tape.
 - Endless loop **24** : Unit plays both sides of tape six times in succession.The unit will display the current Play mode **11**.
5. Press the **Play** button **25** **7** to begin playback. Press the **Reverse Play** button **26** **12** to play the reverse side of the tape. The direction of the tape will be indicated in the display **8**.

6. In either the Stop or Play mode, press the **Fast Forward** **27** **9** button to fast forward to the desired point, or to the end of the side. The **Fast Forward** indicator **13** will light in the display.

To rewind, in either the Stop or Play mode, press the **Rewind** **14** **24** **13** button. The **Rewind** indicator **10** will light in the display.

7. To end playback, press the **Stop/Reset** button **27** **6**.

Alternatively, the unit will stop automatically at the end of the tape.

Tape Counter

The **Tape Counter** **3** will appear in the Information Display when in Tape mode.

During Play or Fast Forward, the **Tape Counter** **3** increases and, during rewind, the tape counter decreases.

While in Stop mode or while playing, press the **Counter Reset** button **29** to reset the counter to zero. This can be convenient for locating the point at which you wish to begin a recording session. Note, however, that the unit will automatically rewind the tape to its beginning and it will not stop when the counter reaches zero.

ENJOYING YOUR SYSTEM

Recording From a CD, Radio or Externally Connected Equipment

Recordings can only be made using Deck B. Only normal bias tapes should be used.

1. Power the unit on **11**, and insert a blank tape into Deck B. Use the **Fast Forward 249** or **Rewind 2413** buttons to proceed to the point where you wish the recording to start. Make sure to proceed past the tape leader to avoid missing the beginning of the source signal.
2. Press the **Play Mode** **●** button repeatedly to select recording on one side only **↔** or to record on both sides in auto reverse mode **↔↔**. We do not recommend that you use the endless loop mode **↔↔**, as it may result in rerecording over desired material that was recorded earlier in the session.
3. Select the source input: **Tuner, CD, AUX 92711635**.
4. Press the **Rec/Pause** button **288** to place the unit in the Recording Ready mode. The **Record** indicator **9** will flash.
5. Press the **Play** button **257** to begin recording onto the front side of the tape. The direction of the tape will be indicated in the display **8**.
6. The recording may be interrupted to skip over undesired material by pressing the **Rec/Pause** button **288**. To resume recording, press either the **Rec/Pause** button **288**, or the **Play** button **257**.
7. To end the recording session (but not the input), press the **Stop/Reset** button **276**. Alternatively, the unit will stop recording automatically when it reaches the end of the tape.

Recording Tapes

CD Sync Recording

The CD Sync recording function dubs a complete CD or programmed tracks automatically onto a cassette.

1. Select the **CD Function** **●**.
2. Open the CD compartment with the **CD Open/Close** button **18**, insert discs and close the CD compartment again.
3. If desired, program a play list of selected tracks (see Programmed Play section on p. 14).

If you wish to record only one track, use the **Forward** or **Reverse Search** buttons **241719** to select that track.

4. Insert a blank tape into Deck B. Use the **Fast Forward 249** or **Rewind 2413** buttons to proceed to the point where you wish the recording to start. Make sure you have enough blank tape available to fully record the CD or programmed play list.
5. Press the **Play Mode** **●** button repeatedly to select recording on one side only **↔** or to record on both sides in auto reverse mode **↔↔**. We do not recommend that you use the endless loop mode **↔↔**, as it may result in rerecording over desired material that was recorded earlier in the session.

If unit is unable to finish recording a track on the first side of the tape, it will record that track completely on the reverse side.

6. Press the **CD Sync** button **4** to begin recording. The unit will play the tape in Mute mode for 7 seconds in order to skip the tape leader; then the CD player will begin playing and the unit will begin recording.

The system will not allow you to select a different input without stopping the recording session.

Recording From Tape to Tape (Dubbing)

This system will only dub recorded materials from Deck A to Deck B, since only Deck B is capable of recording. Use only normal bias tape in this system.

1. Insert a previously recorded cassette in Deck A with the side you wish to copy facing toward you. Insert a blank cassette in Deck B with the side you wish to record on facing toward you.
2. Press the **Tape A/B** button **101011** to select the tape function, and press it repeatedly to select each deck so that you can rewind each tape to the beginning using the **Rewind** button **2413**.
3. Press the **Normal Dub** button **●** to automatically start dubbing at normal (regular playback) speed. Alternatively, press the **High Dub** **●** button to automatically start dubbing at twice normal playback speed. The quality of the recording may be better if Normal Speed dubbing is used rather than High Speed Dubbing. When dubbing at high speed, turn down the **Volume** **1826** to prevent possible damage to the loudspeakers by the high-pitched playback of the source tape.
4. During dubbing, the **Pause** button **288** will have no effect. You cannot change the speed of the dub during a dub. Although the **Volume** control **1826** will affect the level of playback, it will have no effect on the recording level, which is not adjustable.
5. Press the **Stop/Reset** button **276** to end the dubbing session. Alternatively, the unit will stop automatically at the end of the tape.

ADVANCED FEATURES

Dual Alarms and Timer Recording

Alarm and Timer Setting

Your system offers a flexible dual alarm and timer capability, which allows you to program the system to either play or record two different sources at two different times, for as long a duration as you choose.

1. Make sure the current time displayed **3** is correct by pressing the **Clock** button **9**; see the Setting the Clock section of this manual on p. 10 to set the clock correctly. If you plan on selecting the Tuner, make sure that the desired station has been programmed as a preset (see Programming Preset Stations section on p. 12).
2. Press the **Alarm 1** **19** or **Alarm 2** **20** button to enter the timer setting mode. (If the timer was previously set, press and hold the button for more than 1.5 seconds.) The Alarm/Timer clockface indicator will appear in the display **23** and the available source selections – TUNER, CD, TAPE – will flash in the display in turn.
 3. (a) If you want to select the **Tuner**, press the **SET** button **3** while TUNER appears in the display window **3**. “Play” and “Rec” will flash in turn.
 - (b) Press the **SET** button **3** to select either Play or Rec.
 - **Play:** Tuner plays only
 - **Rec:** Tuner plays and is recorded by Deck B. Make sure that a blank cassette is loaded in Deck B and rewound to its beginning or desired starting point.
 - (c) Press the **Preset** **26/25/4** or **26/25/4** button to select a desired radio station. If no Preset stations have been programmed into memory, JBL Soundgear will default to the last tuned station.
 - (d) Press the **SET** button **3** to enter the selected preset number.
 4. If you wish to select a CD or Tape, press the **SET** button **3** while CD or TAPE appears in the display window **3**.

If you have selected CD, or Tape A, “PLAY” and “REC” will flash alternately in the display **3**. Press the **SET** button **3** to select either PLAY or REC. If you choose to make a recording, make sure that a blank cassette is loaded in Deck B and rewound to its beginning or desired starting point.
 5. Set the hour by pressing the **Preset** **26/25/4** or **26/25/4** buttons.
 6. Press the **SET** button **3** to enter the hour the alarm will turn the selected source on. The minutes will flash **3**.
 7. Set the minutes by pressing the **Preset** **26/25/4** or **26/25/4** buttons.

8. Press the **SET** button **3** to enter the minutes. “OFF” will flash in the display **3**, and the menu will now guide you through setting the time the system will turn off.
9. Program the time to turn off in the same way as the time to turn on, by using the **Preset** **26/25/4** or **26/25/4** buttons to select the hour or minute, and the **SET** button **3** to enter the setting.
10. Set the volume level by pressing the **Preset** **26/25/4** or **26/25/4** buttons.
11. Press the **SET** button **3** to enter the selected volume level. The clockface and the Alarm number (1 or 2) will remain lit in the display **23**, and the alarm will be set and armed.
12. When you turn the power off **11**, the unit will automatically turn itself on at the programmed time and play and/or record the selected source for as long as it has been programmed to play.

To Cancel or Check the Timer:

Each time the **Alarm 1** **19** or **Alarm 2** **20** button is pressed you can arm or disarm that alarm. If the alarm was previously set, press the button **19/20** twice to display the alarm settings. Press it once to disarm the alarm, but retain any settings in memory. When the alarm is armed, the clockface and alarm number (1 or 2) indicators will light in the display **23** as will the REC indicator **24** if applicable. When the alarm is disarmed, the indicators will go out.

Alarm and Timer Notes

1. The **Alarm** indicator **23** will flash when the unit is playing in Alarm mode. Press the **Alarm** button **19/20** to defeat the alarm, which will not shut the unit off.
2. When CD or Tape is selected for playback, if no disc is in the disc drawer or no cassette tape is in the cassette deck, the Tuner function will turn on instead.
3. When CD is selected for playback, **Repeat All Disc** will be selected automatically.
4. When TAPE is selected for playback, if both cassette decks have cassette tapes; the cassette tape in Deck B will play first.
5. If the unit is turned on manually, it will not shut off automatically at the programmed turn-off time.
6. If both Alarm 1 and Alarm 2 are set, and their times do not overlap – that is, the earlier alarm is programmed to turn off before the later alarm will turn on – then both alarms will turn the unit on and off as programmed.

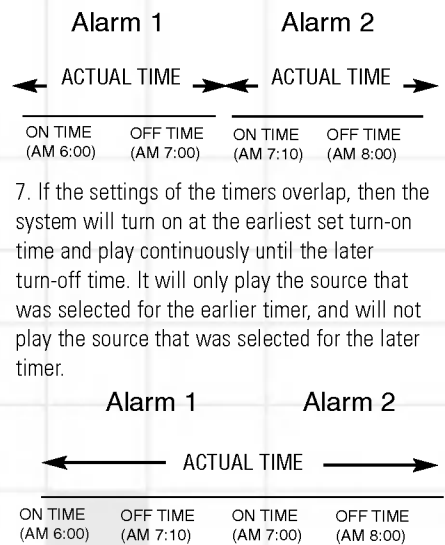

Setting the Sleep Timer

(Available only using the remote control)
When the sleep timer is used, the power is automatically turned off after the specified time has elapsed.

1. To specify the time until the power is turned off, press the **Sleep** button **14**. “SLEEP 90” will appear in the display **3** for about 5 seconds. This means that the unit will turn off automatically after 90 minutes. Each time the **Sleep** button **14** is pressed while the SLEEP display appears, the time interval before the unit will turn off is reduced by 10 minutes (e.g., 80...70...). Select the desired time interval before turn-off.
2. To check the remaining time until the power is turned off, while the sleep function is active, press the **Sleep** button **14** briefly. The time remaining until turn-off is displayed for about 5 seconds.

Note: If you press the **Sleep** button **14** while the sleep time is displayed, the SLEEP timer will reduce the time until turn-off.
3. To cancel the sleep timer, press the **Sleep** button **14** repeatedly until “10” appears, and then press the SLEEP button once again while “10” is displayed.

TROUBLESHOOTING

If there is no sound from either of the speakers:

- Check that the unit is plugged into an active electrical outlet.
- Check that the unit is turned on, and that a source is selected and playing. If Tape or CD was selected, make sure that a cassette or disc has been inserted.
- Check that the Mute function has not been selected and, if it has, turn it off using the remote control.
- Adjust the Volume Control **13**.
- Check all wires and connections between the main unit and the speakers (see page 9). Make sure all wires are connected, and that none of the speaker wires are frayed, cut or punctured.
- If an external (auxiliary) source was selected, make sure that the external unit is either plugged into an active electrical outlet or powered by fully charged batteries. Make sure that the external unit is turned on and playing. Make sure that all wires between the main unit and external unit are connected correctly, and that none of the wires are frayed, cut or punctured.

If there is no sound coming from one speaker:

- Check all wires and connections between the main unit and the speakers (see page 9). Make sure all wires are connected and that none of the speaker wires are frayed, cut or punctured.

If the system plays at low volumes but shuts off as volume is increased:

- Check all wires and connections between the main unit and the speakers (see page 9). Make sure all wires are connected, and that none of the speaker wires are frayed, cut or punctured.

If there is low (or no) bass output:

- Make sure the connections to the left and right speaker inputs **14** have the correct polarity (+ and -).
- Consider experimenting with the **Boost** function **15** by selecting either PowerBass or Super Boost.
- Consider adding a powered subwoofer to your system.

If there is low (or no) treble output:

- Check all wires and connections between the main unit and the speakers (see page 9). Make sure all wires are connected, and that none of the speaker wires are frayed, cut or punctured.
- For Model FFH-3130, make sure the yellow plug is connected to the correct **Tweeter/Midrange** jack **16** on the rear panel
- Consider experimenting with the **Boost** function **15** by selecting Treble Boost or Super Boost.

- As a preventive measure to avoid damaging your speakers, make sure never to exceed the maximum volume when playing your system.

If the unit does not respond to remote control commands:

- Make sure the batteries are not weak, and replace them if necessary.
- Make sure the remote sensor in the front panel of the main unit is not blocked.
- Make sure the remote is no further than 23 feet (7 meters) away from the main unit, and that it is aimed at the sensor head-on and not at too much of an angle (no more than 30 degrees from the center line).
- Turn off any fluorescent light in the vicinity of the main unit.

If the tuner (radio) buzzes or does not play properly:

- Make sure you have tuned in to a frequency that is in use in your area.
- Check the antenna connection, and adjust the placement of the antenna wires for best reception.

If RDS (Radio Data System) information does not appear in the display:

- Make sure you have selected the FM band, as RDS is not available on AM.
- When the station's signal is weak, the audio signal may come through without the RDS signal.
- For the first few seconds, the RDS data will be garbled until the unit fully processes the signal.

When attempting to delete a single preset station, all presets are erased:

It is not possible to delete a single Preset station, although it can be changed to a different station (see page 12).

When attempting to delete a single track from a programmed CD play list, the entire play list was erased:

It is not possible to delete a single track from a play list, although the track can be replaced by a different track (see page 14).

If no sound is heard when tape is playing:

- Make sure tape is not blank.

If tape does not record:

- Make sure record protection tabs have not been removed from cassette. If they have, you may cover the protection holes with adhesive tape.
- Make sure a source is playing.
- If dubbing, make sure the tapes are in the correct decks – the source in Deck A, and the blank in Deck B.
- Make sure you are not attempting to record onto a tape in Deck A, as that deck is for playback only.

If tapes sound distorted:

- Make sure to use only normal bias tapes in the unit.
- Make sure tape heads are clean and demagnetized.

If a tape recording tapes over material recorded earlier in the same session:

- Make sure you have selected either One side or All sides, but not Endless loop, using the **Play Mode** function **17**.

If a tape rewinds past zero:

The unit detects the beginning of the tape rather than the counter number and this behavior is normal.

If Deck A does not auto-reverse:

Deck A is not equipped with this feature, and will always stop at the end of each side.

If CD does not play:

- Make sure drawer contains disc to play.
- Make sure disc is not upside down in tray.
- Make sure disc is of type CD or CD-R only.

If CD skips or stutters during play:

- Make sure disc is not damaged.
- Make sure main unit is set securely on a stable surface, free from vibrations.

If the unit did not turn on at the programmed alarm time:

- Check programmed time – was AM or PM selected correctly? Was 24-hour or 12-hour time display selected as desired?
- Make sure the unit was not left turned on.

If the unit did not turn on and make a recording at the programmed alarm time:

- Make sure time was programmed correctly.
- Make sure a blank tape was inserted in Deck B and rewind.

SPECIFICATIONS

System	FFH-2120	FFH-3130
Output Power	100 Watts total 65W + 65W (1% THD, 50Hz – 20kHz)	130 Watts total (bi-amplified) 30W + 30W (1% THD, 200Hz – 20kHz) 60W + 60W (1% THD, 50Hz – 20kHz)
Sound Pressure Level	107dB	108dB
Frequency Response	45Hz ~ 20kHz	40Hz ~ 20kHz
Signal-to-Noise Ratio (Aux Input)	80dB	80dB
Dimensions (W x H x D)		
Main Unit	273mm x 327mm x 343mm (10-3/4" x 12-7/8" x 13-1/2")	273mm x 327mm x 343mm (10-3/4" x 12-7/8" x 13-1/2")
Speakers (each)	219mm x 333mm x 248mm (8-5/8" x 13-1/8" x 9-3/4")	219mm x 374mm x 248mm (8-5/8" x 14-3/4" x 9-3/4")
Net Weight		
Main Unit	8.73kg (19.2 lb)	10.1kg (22.2 lb)
Speakers (each)	4.91kg (10.8 lb)	5.23kg (11.5 lb)
Shipping Weight (system, accessories, packing)	21.5kg (47.3 lb)	23.64kg (52 lb)
Speaker System		
Type	Ported 2-way	Ported 3-way bi-amplified
Woofer	6-1/2"(165mm) PolyPlas™ with rubber surround	6-1/2"(165mm) PolyPlas with rubber surround
Midrange	N/A	3" PolyPlas with rubber surround
Tweeter	13mm(1/2") Titanium-laminate dome with EOS™ waveguide	13mm(1/2") Titanium-laminate dome with EOS™ waveguide
Impedance	6Ω	6Ω
Max Input power(MAIN)	130W	60W
Max Input power(Super Woofer)		120W
CD		
Frequency Response	40Hz ~ 20kHz (+0,-2dB)	40Hz ~ 20kHz (+0,-2dB)
Signal-to-Noise Ratio	70dB	70dB
Tuner		
FM		
Tuning Range	87.5MHz ~ 108MHz	87.5MHz ~ 108MHz
Intermediate Frequency	10.7MHz	10.7MHz
Signal-to-Noise Ratio (Mono/Stereo, 98MHz)	61/58dB	61/58dB
Frequency Response	60Hz ~ 10000Hz	60Hz ~ 10000Hz
AM(MW)		
Tuning Range	522kHz ~ 1611kHz, 530kHz ~ 1720kHz or 530kHz ~ 1610kHz	522kHz ~ 1611kHz, 530kHz ~ 1720kHz or 530kHz ~ 1610kHz
Intermediate Frequency	450kHz	450kHz
Frequency Response	100Hz ~ 2000Hz	100Hz ~ 2000Hz
SW(optional)		
Tuning Range	5.8MHz ~ 18MHz	5.8MHz ~ 18MHz
Intermediate Frequency	450kHz	450kHz
LW(optional)		
Tuning Range	153kHz ~ 281kHz	153kHz ~ 281kHz
Intermediate Frequency	450kHz	450kHz
Cassette Deck		
FF, REW Time (C-60)	120 sec.	120 sec.
Frequency Response	125Hz ~ 8000Hz (±3dB)	125Hz ~ 8000Hz (±3dB)
Signal-to-Noise Ratio	43dB	43dB
Channel Separation	50dB	50dB

NOTE: All features and specifications are subject to change without notice.



P/N:3828R-A041W