

# DLP PROJECTOR

## USER'S GUIDE

Thank you for purchasing the DLP Projector.

**Please read this user's guide to ensure correct use of the device.** Save this user's guide for future reference.

## OUTLINE

This DLP Projector can display various computer signals and NTSC/PAL/SECAM video signals.

## FEATURES

---

- 1. High Brightness**
- 2. High Resolution**
- 3. Compact Size, Feather Weight for Portability**
- 4. Durable Magnesium Alloy Body**
- 5. RGB input Terminal**
- 6. One Touch Auto-Adjustment Function**
- 7. Easy Keystone Adjustment**

## **Copyright**

Copyright © 2003. All rights reserved. No part of this publication may be reproduced, transmitted, transcribed, stored in a retrieval system or translated into any language or computer language, in any form or by any means, electronic, mechanical, magnetic, optical, chemical, manual or otherwise, without the prior written permission of the company.

## **Disclaimer**

The company makes no representations or warranties, either expressed or implied, with respect to the contents hereof and specifically disclaims any warranties, merchantability or fitness for any particular purpose. Furthermore, the company reserves the right to revise this publication and to make changes from time to time in the contents hereof without obligation of the company to notify any person of such revision or changes.

# Table of Contents

<b>Introduction</b> .....	<b>1</b>
Safety Instructions .....	1
FCC Statement .....	2
EEC STATEMENT .....	2
Shipping Contents .....	3
Optional Accessories .....	3
Projector Description .....	4
Projector .....	4
External Control Panel .....	5
Adjuster .....	6
Projector Features .....	6
Remote Control Description .....	7
Installing or Replacing Batteries .....	9
<b>Installation</b> .....	<b>10</b>
Display Size .....	10
Connecting to Various Equipment .....	11
<b>Operation</b> .....	<b>12</b>
Start Up .....	12
Digital Keystone Correction .....	13
Auto Adjustment .....	13
Source Selection .....	14
Menu System .....	14
1. VIDEO Menu .....	15
2. POSITION Menu .....	16
3. SPECIAL Menu .....	17
4. TRACKING Menu .....	18
Shutdown .....	19
<b>Maintenance</b> .....	<b>20</b>
Lamp Information .....	20
Use and Replacement of the Lamp .....	20
Lamp Replacement .....	20
Operative Information .....	21
<b>Troubleshooting</b> .....	<b>22</b>
Common Problems & Solutions .....	22
Status Messages .....	22

---

<b>Specifications</b>	<b>.23</b>
Projector Specifications	23
Timing Chart	24
<b>Dimensions</b>	<b>.25</b>

# INTRODUCTION

---



## Caution

**TO PREVENT SHOCK, DO NOT OPEN THE CABINET. NO USER –SERVICEABLE PARTS INSIDE. REFER SERVICING TO QUALIFIED SERVICE PERSONNEL. PLEASE READ THIS USER’S GUIDE BEFORE YOU OPERATE YOUR PROJECTOR. SAVE THIS USER’S GUIDE FOR FUTURE REFERENCE .**

---

## Safety Instructions

1. Read this user’s guide before you operate your projector and save it for future reference.
2. The lamp becomes extremely hot during operation. Allow the projector to cool for approximately 45 minutes prior to removing the lamp assembly for replacement. Do not operate lamps beyond the rated lamp life. Excessive operation of lamps beyond the rated life could cause them to explode on rare occasions.
3. Never replace the lamp assembly or any electronic components unless the projector is unplugged.
4. To reduce the risk of electric shock, do not disassemble this appliance. Take it to a qualified technician when service or repair is required. Incorrect reassembly can cause electric shock when the appliance is subsequently used.
5. Do not place this product on an unstable cart, stand, or table. The product may fall, sustaining serious damage.
6. Do not touch the top cover when the projector is under operation.
7. The projector must be packaged into a carry bag while moving to another place for operation.

---

## Caution

- Always open the lens shutter when the projector lamp is on.
  - Do not look straight at the projector lens during operation. The intense light beam may damage your eyes.
  - In some countries, the line voltage is NOT stable. This projector is designed to operate safely within a bandwidth of 100 to 240 volts, but could fail if power cuts or surges of  $\pm 10$  volts occur. In these high-risk areas, it is recommended that a power stabilizer unit be used in conjunction with this projector.
  - Do not place this projector on the top of cloth or carpet.
  - Do not touch the ventilation grill when the projector is under operation.
- 

**Save this user's guide:** The information contained in this manual will assist you in operating and maintaining your personal projector.

## FCC Statement

**CLASS B:** This equipment generates, uses and can radiate radio frequency energy and, if not installed and used in accordance with the instructions, may cause harmful interference to radio communications. However, there is no guarantee that interference will not occur in a particular installation. If this equipment does cause harmful interference to radio or television reception, which can be determined by turning the equipment off and on, the user is encouraged to try to correct the interference by one or more of the following measures:

- Reorient or relocate the receiving antenna.
- Increase the distance between the equipment and receiver.
- Connect the equipment into an outlet on a circuit different from that to which the receiver is connected.
- Consult the dealer or an experienced radio/TV technician for help.

## EEC STATEMENT

This machine was tested against the 89/336/EEC (European Economic Community) for EMC (Electro Magnetic Compatibility) and fulfills these requirements.

# Shipping Contents

The Projector is shipped with the cables required for connection to standard PC or laptop computers. Carefully unpack and verify that you have all the items shown below. If any of these items are missing, please contact personnel at the place of purchase.

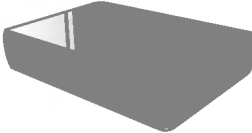

Projector



User's Guide



Quick Start Guide



Remote Control



3-2 Converter



Batteries



Deluxe Soft Carry Case

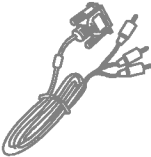

HDTV Cable (YPbPr)

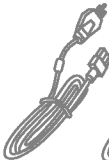

S.A. & India



220V



240V



110V

Power Cord



VGA Cable



USB Cable



Video Cable

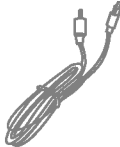

S-Video Cable

## Optional Accessories

- 1. 150W lamp module
- 2. Macintosh adapter

# Projector Description

## Projector

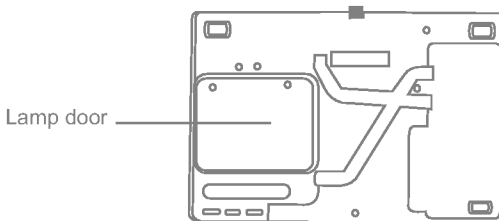
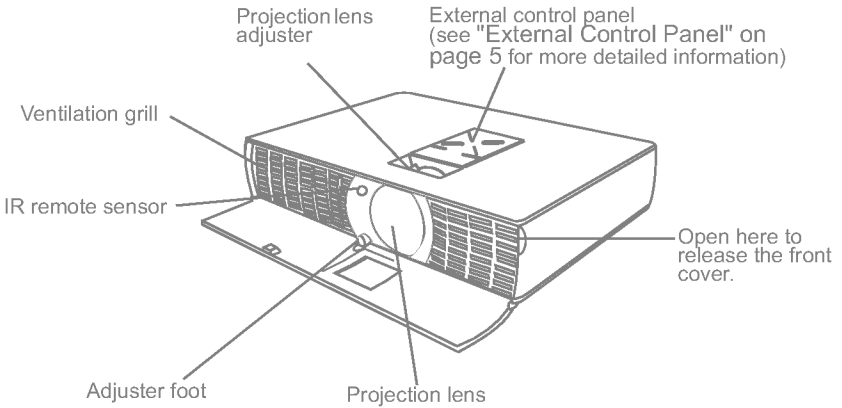
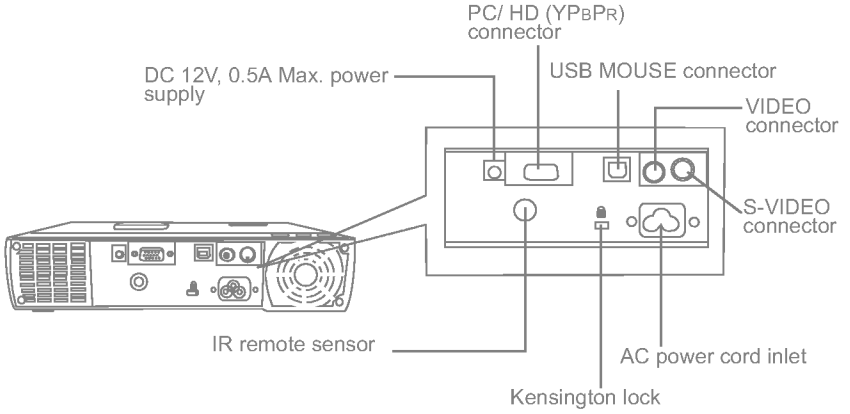



## External Control Panel

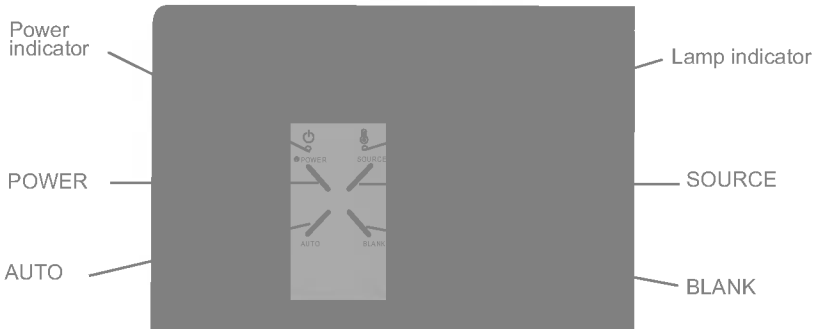

### Power indicator

The indicator shows green for a normal state. When the projector is operated improperly, it shows green or orange toggle. See "Operative Information" on page 21 for more detailed information.

### POWER

Press the **POWER** key to turn the projector on or off.

### AUTO

Automatically determines the best picture settings for current received signals. (PC Mode Only)

### Lamp Indicator

The Lamp Indicator will light up when the lamp needs service, cooling or replacement. See "Lamp Information" on page 20 for more detailed information.

### SOURCE

Selects signal sources from among PC, Video, S-Video and YPBPR.

### BLANK

Selects to display an entirely blue, black, green or LG logo screen.

## Adjuster

The projector is equipped with 1 quick-release adjuster foot. Push the button to adjust its tilt angle.

1. Lift the projector up and press the adjuster button to release the adjuster.
2. The adjuster will drop into position and be locked.

**Note: The adjuster can only bear the weight of the projector itself . Please do not place any additional weight burden on it.**

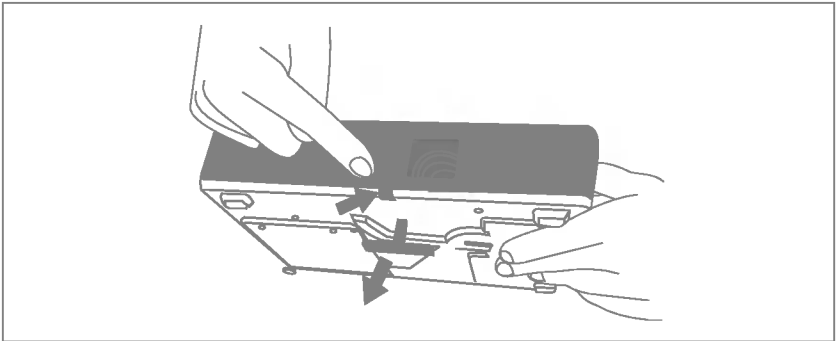

## Projector Features

The projector integrates high-performance optical engine projection and a user-friendly design to deliver high reliability and ease of use.

The projector offers the following features:

- Small and light for portability.
- Full-function remote control with laser pointer/ remote mouse function.
- High quality manual zoom lens.
- One-key auto-adjustment to display the best picture quality in PC mode.
- Easy digital keystone correction through hot keys to correct distorted images.
- High resolution.
- Ultra-high brightness projection lamp.
- Ability to display 16.7 million colors.
- On-screen menus in 8 languages: English, French, German, Italian, Spanish, Korean, Simplified Chinese, and Traditional Chinese.
- Powerful AV function to provide high quality AV picture.
- HDTV compatibility (YPbPr).
- Durable magnesium alloy body.

**Note: The brightness of the projected image will vary depending on the ambient lighting conditions and contrast/brightness settings.**

## Remote Control Description

The remote control sensors are located in the front/ back of the projector.

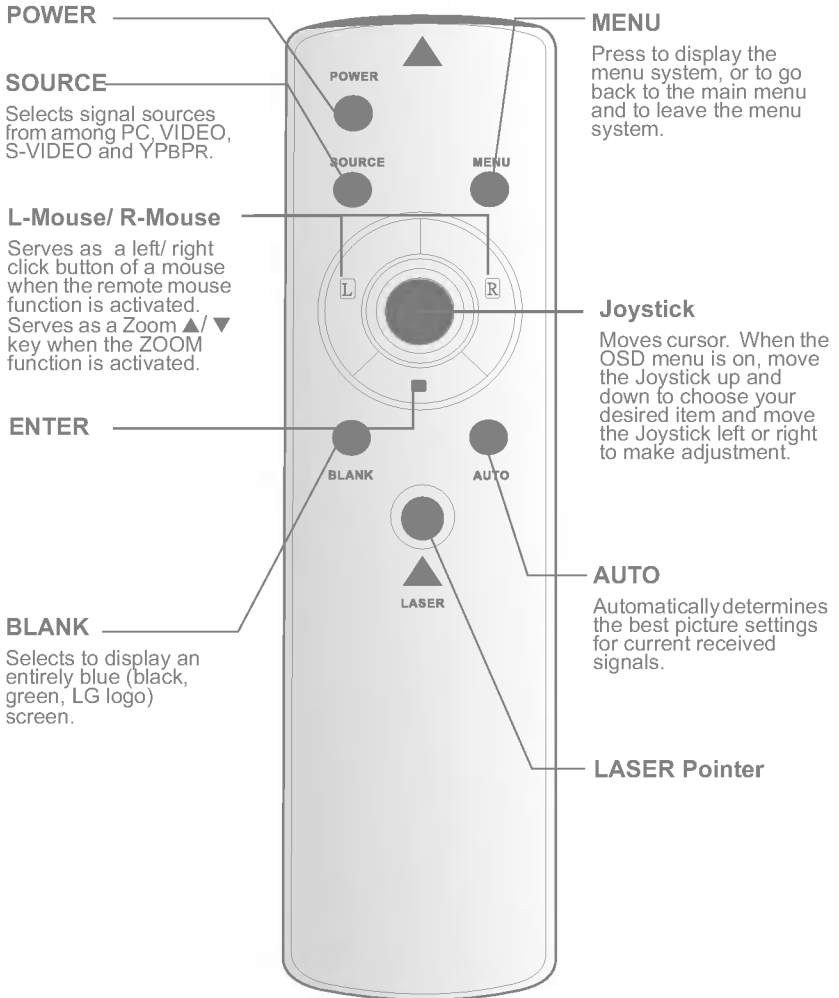

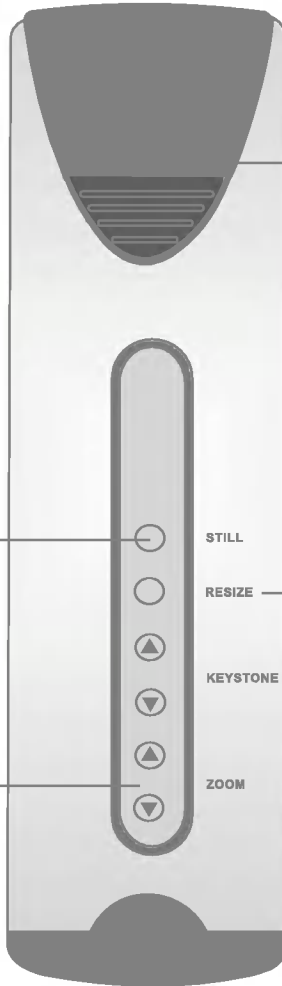

### MOUSE DRAG

When the remote control works as a mouse, choose your desired item and press **MOUSE DRAG**. Drag it to wherever you want on the projection image and press **MOUSE LEFT** to release the item.

### STILL

Makes the projection image still.

STILL

RESIZE

### RESIZE

Scales the original input resolution.

KEystone

### KEystone ▲ ▼

Refer to "Digital Keystone Correction" on page 13.

### ZOOM

By pressing "ZOOM" button, zoom rectangular displays in the center, but to activate it, customer should press "ENTER" button and then it can be adjusted by Joystick.

ZOOM

## Installing or Replacing Batteries (“AA” type)

- Press and open the battery compartment lid in the direction.

- Install batteries as indicated by the diagram inside the compartment.

- Position the lid over the compartment and snap it back into place.

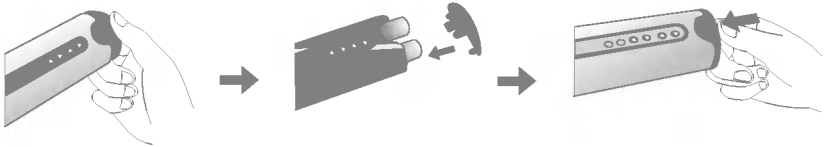

---

### **Caution**

**Avoid excessive heat and humidity. There may be danger of an explosion if batteries are incorrectly replaced. Replace only with the same or equivalent type recommended by the manufacturer. Dispose of used batteries according to the manufacturer's instructions.**

---

# INSTALLATION

## Display Size

Place the projector at the required distance from the screen according to the desired picture size (see the table below). The effective display size is from 26 to 178 inches diagonally for RD-JT31 and from 33 to 228 inches diagonally for RD-JT30.

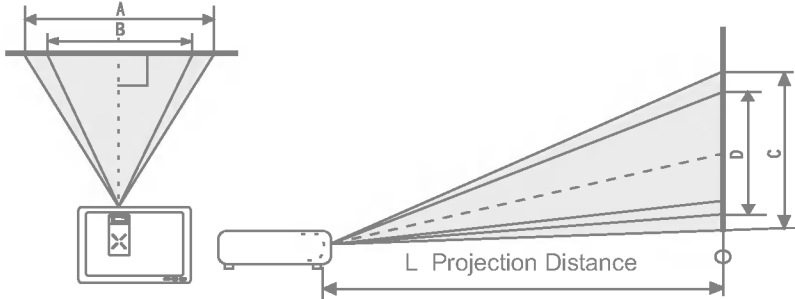

- RD-JT31 display size chart

Display Size (Max.)			L. Projection Distance (cm)	Display Size (Min.)		
Diagonal (in)	A. Width (cm)	C. Height (cm)		Diagonal (in)	B. Width (cm)	D. Height (cm)
33.4	67.9	50.9	150	25.7	52.2	39.2
44.5	90.5	67.9	200	34.3	69.6	52.2
66.8	135.7	101.8	300	51.4	104.4	78.3
89.1	181.0	135.7	400	68.5	139.2	104.4
111.3	226.2	169.7	500	85.6	174.0	130.5
133.6	271.5	203.6	600	102.8	208.8	156.6
155.9	316.7	237.5	700	119.9	243.6	182.7
178.1	362.0	271.5	800	137.0	278.4	208.8

- RD-JT30 display size chart

Display Size (Max.)			L. Projection Distance (cm)	Display Size (Min.)		
Diagonal (in)	A. Width (cm)	C. Height (cm)		Diagonal (in)	B. Width (cm)	D. Height (cm)
42.8	86.9	65.2	150	32.9	66.8	50.1
57.0	115.8	86.9	200	43.8	89.1	66.8
85.5	173.7	130.3	300	65.8	133.6	100.2
114.0	231.6	173.7	400	87.7	178.2	133.6
142.5	289.6	217.2	500	109.6	222.7	167.1
171.0	347.5	260.6	600	131.5	267.3	200.5
199.5	405.4	304.0	700	153.5	311.8	233.9
228.0	463.3	347.5	800	175.4	356.4	267.3

## Connecting to Various Equipment

### HDTV description

The projector is capable of displaying various High Definition TV display modes. Some of these sources are:

- Digital-VHS (D-VHS) player
- DVD player
- Satellite Dish HDTV receiver
- DTV tuners

Most of these sources will provide an analog component video output, a standard VGA output, or a YPBPR (default) format.

The projector is capable of accepting HDTV data through a YPBPR connector. Use a HDTV cable that came with your projector to display HDTV images.

The following standards are supported in the HDTV function:

- 480i
- 480p
- 720p
- 1080i

Please refer to "Menu System" on page 14 for information on the HDTV (YPBPR) OSD selections.

### Connecting to Various Equipment

It only takes a few seconds to connect your projector to your desktop or notebook computer, VCR, or other systems. However, a Mac adapter (an optional accessory) is needed for connection to Macintosh computers.

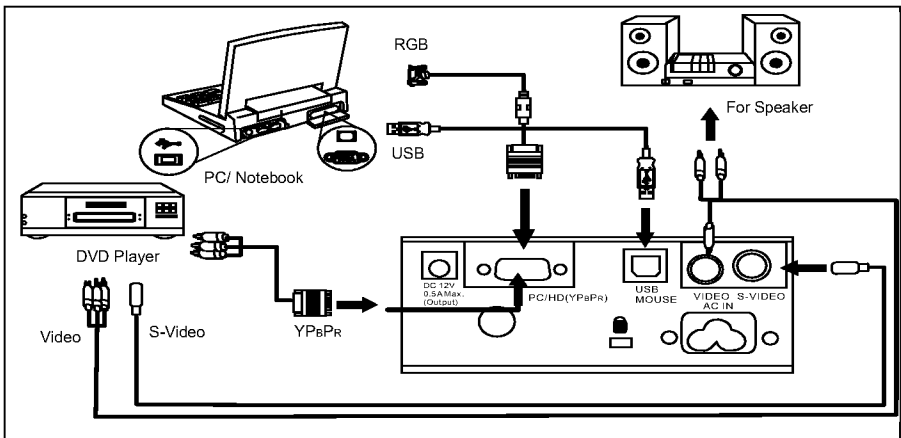

# OPERATION

## Start Up

1. Plug the power cord into a wall socket. Open the front Door to Power ON.

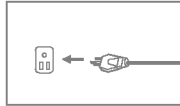

(110V)

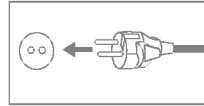

(220V)

2. When plugging-in, the ORANGE Led light. Press the Power button to turn on the projector. Then, the fan will start to operate while the ORANGE Led is blinking. After 15 seconds, LG logo will display and pictures will be on after the next 15 seconds. (Green Led on)

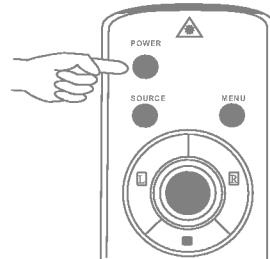
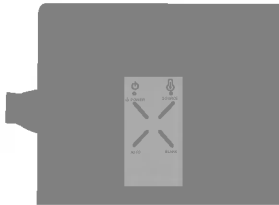

3. Switch on all connected equipment.



## Digital Keystone Correction

Keystoning refers to the situation where the projected image is noticeably wider at either the top or bottom. To correct this, press KEYSTONE ▲/ ▼ (hot key) on the remote control, and then adjust the sliding bar labeled Keystone, as needed. Press ▲ to correct keystoning at the top of the image. Press ▼ to correct keystoning at the bottom of the image.

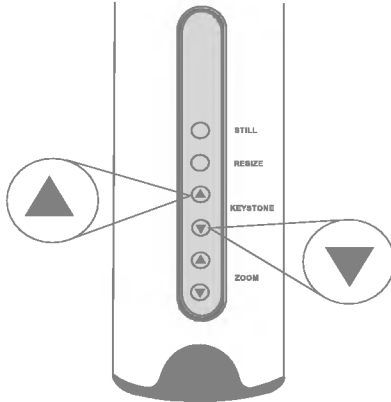

## Auto Adjustment

In some cases, you may need to optimize the picture quality. To do this, press the AUTO key on the control panel of the projector or on the remote control. The built-in Intelligent Auto Adjustment function will re-adjust settings to provide the best picture quality.

*\*This function is available only in PC mode.*

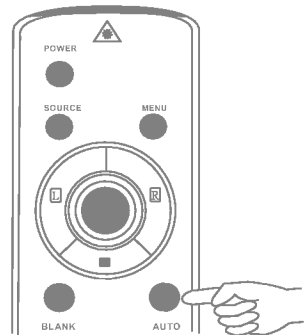
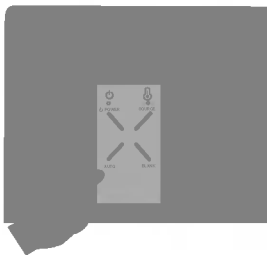

## Source Selection

When several input sources are available, press the SOURCE key to make a selection from the control panel of the projector or the remote control.



## Menu System

Press **Menu** for the main menu, and then press Joystick to select a sub-menu. Press **ENTER** again to select items in the sub-menu.

	Main Menu		POSITION		TRACKING
	<b>YPbPr Video S-Video</b>	Contrast Brightness Color Tint Reset	Keystone Zoom Resize	Language Flip Horizontal Flip Vertical Blank Image Lamp Time	
	<b>PC (RGB)</b>	Contrast Brightness Color R Color G Color B Reset	Horizontal Vertical Keystone Zoom Resize	Language Flip Horizontal Flip Vertical Blank Image Lamp Time	Auto Tracking Clock Phase

## 1. VIDEO Menu

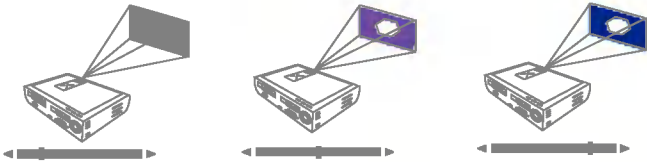
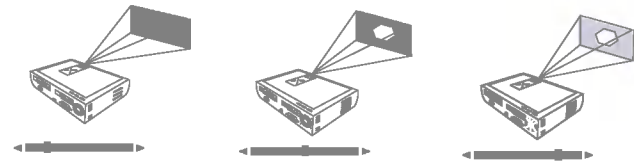
<p><b>Contrast</b></p>	<p>Adjusts the degree of difference between dark and light in the image.</p> 
<p><b>Brightness</b></p>	<p>Adjusts the brightness of the image.</p> 
<p><b>Color</b></p>	<p>Increases or decreases the color range of the image.  <i>*This function is not available when the input mode is PC.</i></p>
<p><b>Tint</b></p>	<p>Adjusts the image to make it appear more red or green.  <i>*This function is not available when the input mode is PC or PAL signal.</i></p>
<p><b>Color R</b>  <b>Color G</b>  <b>Color B</b></p>	<p>Increases or decreases the color temperature (R, G, B) of the image.  <i>*This function is only available when the input mode is PC.</i></p>
<p><b>Reset</b></p>	<p>Returns all settings to the factory preset values.</p>

## 2. POSITION Menu

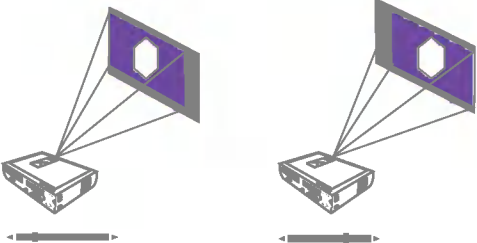
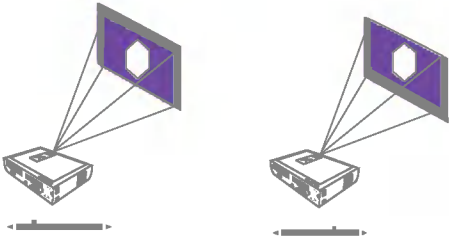
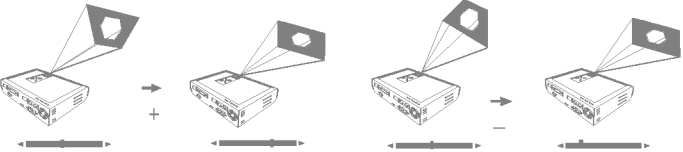
<p><b>Horizontal</b></p>	<p>Adjusts the horizontal position of the projected image.</p> 
<p><b>Vertical</b></p>	<p>Adjusts the vertical position of the projected image.</p> 
<p><b>Keystone</b></p>	<p>Corrects any keystone of the image.</p> 
<p><b>Zoom</b></p>	<p>Activates Zoom function.</p>
<p><b>Resize</b></p>	<p>When in YPbPr, Video and S-Video modes, users have two options for the image ratio: 4:3 and 16:9.          When in PC mode, users have two options for the image ratio: Scaled and Original.          JT30(XGA) operates in SVGA and VGA modes and JT31(SVGA) operates only in VGA mode.</p>

### 3. SPECIAL Menu

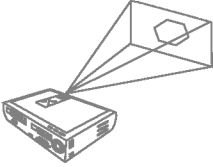
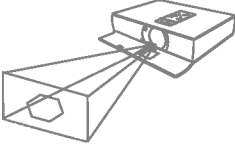
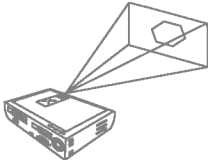
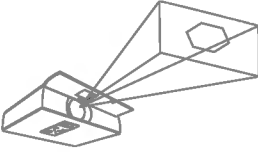
<b>Source</b>	It's the same function with the SOURCE button on the remote control.	
<b>Language</b>	Language sets the language for the OSD control menus. Use the Joystick to select the desired language from among English, French, German, Italian, Spanish, Korean, Simplified Chinese and Traditional Chinese.	
<b>Flip Horizontal</b>	<p>Default</p> 	<p>Projects images when the projector is 180 degrees horizontally rotated.</p> 
<b>Flip Vertical</b>	<p>Default</p> 	<p>Projects images when the projector is 180 degrees vertically rotated.</p> 
<b>Blank Image</b>	Chooses blank image from among blue, black, green and LG logo.	
<b>Lamp Time</b>	Shows lamp usage time.	

## 4. TRACKING Menu

This sub-menu only works in PC mode.

TRACKING Menu	
<b>Auto Tracking</b>	It's the same function with the AUTO button on the remote control.
<b>Clock</b>	Adjusts to fit in the desired image size.
<b>Phase</b>	Adjusts to avoid the occurrence of flicker. 

## Shutdown

1. Press **POWER** and a warning message will appear. To turn off the projector, press **POWER** again.

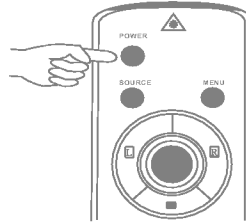

Are You Sure To Power Off?

2. To cool down the projector, the fan will continue to run for approximately 90 seconds, during which the LED will flash.  
*\* After the projector is turned off, there is a 90-second cooling period before the projector can be re-started.*
3. Disconnect the power cord from the wall socket.

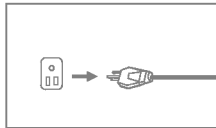

(110V)

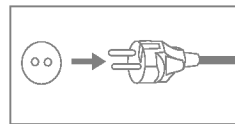

(220V)

---

### Caution

- Please do not unplug the power cord before **POWER** is shut down or during the two-minute cooling process.
  - If the projector is not properly shut down, to protect the lamp, the system will detect this and cool the lamp for 90 seconds automatically before turning on again.
-

# MAINTENANCE

## Lamp Information

### Use and Replacement of the Lamp

The lamp life is 1500 hours. When the Power Indicator lights up red and the Lamp Indicator lights up orange or a message appears suggesting the time of lamp replacement, please install a new lamp or consult your dealer. An old lamp could cause a malfunction in the projector and in rare instances may even explode.

### Lamp Replacement

Please check with LG service center for the information of lamp replacement.

---

#### **Caution**

#### **HIGH VOLTAGE/ HIGH TEMPERATURE/ HIGH PRESS**

**WHEN REPLACING THE LAMP, TURN OFF THE PROJECTOR AND PULL OUT THE CORD FROM THE RECEPTACLE BEFORE REPLACING THE LAMP.**

**WAIT UNTIL THE LAMP BECOMES COOL (MINIMUM 45 MINUTES).**

**TOUCHING THE LAMP WHEN IT IS HOT MAY CAUSE A BURN ON YOUR HAND.**

**HIGH-PRESSURE LAMP WHEN HOT MAY EXPLODE IF IMPROPERLY HANDLED.**

**To reduce the risk of injuries to fingers and damage to internal components, use caution when removing lamp glass that has shattered into sharp pieces.**

**To reduce the risk of injuries to fingers and/or compromising image quality by touching the lens, do not touch the empty lamp compartment when the lamp is removed.**

**This lamp contains mercury. Consult your local hazardous waste regulations to dispose of this lamp in a proper manner.**

---



## Operative Information

When the two LED light up, they are warning you of the following possible problems:

State	LEDs Display		Description
	Operation LED	Status LED	
Normal	Green	No color	Projector runs as Normal State. Lamp Time < 1400 hours Temperature < 72°C
Lamp On Error	Orange	Orange	Check whether the Lamp is lit or not.
Lamp Time over Error	Orange	Orange Toggle	1400 hours < Lamp Time < 1500 hours
	Red	Orange	Lamp Time > 1500 hours Please change the lamp to keep good performance.
Temperature error	Orange	Red Toggle	72°C < Temperature < 74°C
	Red	Red	Temperature > 74°C The lamp temperature is very high! Please turn off the projector.
Front cover closed	Green	Red	Check whether the Front cover is closed.
Fan On Error	Orange Toggle	Red	Check whether Fan is operated normally or not.
Lamp Case Open	Green	Orange	Check whether Lamp case is open.

# TROUBLESHOOTING

## Common Problems & Solutions

PROBLEMS	TRY THESE SOLUTIONS
<b>NO POWER</b>	<ul style="list-style-type: none"><li>• Make sure the power cord is inserted snugged into the AC adapter socket.</li><li>• Make sure the power cord is inserted snugged into the power outlet.</li><li>• Wait 90 seconds after the projector is turned off before turning the projector back on.</li><li>• Check whether Front Cover is closed.</li></ul>
<b>NO PICTURE</b>	<ul style="list-style-type: none"><li>• Check for the proper input source.</li><li>• Ensure all cables are connected properly.</li><li>• Adjust the brightness and contrast.</li></ul>
<b>TRAPEZOID IMAGE ON THE SCREEN</b>	<ul style="list-style-type: none"><li>• Reposition the unit to improve its angle on the screen.</li><li>• Use the <b>Keystone</b> correction key on the remote control unit.</li></ul>
<b>POOR COLOR</b>	<ul style="list-style-type: none"><li>• Select the correct video system.</li><li>• Adjust brightness, contrast, or saturation.</li></ul>
<b>BLURRED IMAGE</b>	<ul style="list-style-type: none"><li>• Press <b>Auto</b> on the control panel of the projector or the remote control unit to get better picture quality.</li><li>• Adjust the focus.</li><li>• Reposition the unit to improve its projection angle.</li><li>• Ensure the distance between the unit and screen is within the adjustment range of the lens.</li></ul>
<b>REMOTE CONTROL DOES NOT WORK</b>	<ul style="list-style-type: none"><li>• Replace the batteries with new ones.</li><li>• Make sure there is no obstacle between the remote control and the projector.</li><li>• Make sure nothing is blocking the front and rear receivers.</li></ul>

## Status Messages

On-Screen Messages	Description
<b>No Signal</b>	Projector is searching for input.
<b>Out of Range</b>	Input signal frequency exceeds the projector's range.
<b>Replace the Lamp</b>	The lamp has been in operation for over 1500 hours. The warning message will display on screen. Repalce the lamp when the warning message displays or the projector may not be turned on.

# SPECIFICATIONS

## Projector Specifications

### Technical Specifications

**Note: All specifications are subject to change without notice.**

#### General

Product name	Personal Projector
Model name	RD-JT30      1024X768 XGA RD-JT31      800X600 SVGA

#### Optical

Display system	1-CHIP DMD
Lens F/Number	F/2.4
Lamp	150W NSH lamp

#### Electrical

Power supply	AC100 ~ 240V, 3A, 50/60 Hz (Automatic)
Power consumption	250 W (Max)

#### Mechanical

Dimensions	248 mm (W) x 59 mm (H) x 170 mm (D)
Operating temperature range	5°C ~ 35°C
Weight	3 lbs (1.7 Kg)

#### Input terminal

Computer input	
RGB input (HDTV: YPBPR)	D-sub 15-pin (female)
Video signal input	
S-VIDEO	Mini DIN 4-pin port x1
VIDEO	RCA jack x1

#### Output

USB mouse connector	A/B series x1
---------------------	---------------

## Timing Chart

Resolution	H Sync (kHz)	V Sync (Hz)	Remark
640x350	31.5	70.1	
640x400	37.9	85.1	VESA
720x400	31.5	70.0	
720x400	37.9	85.1	VESA
640x480	31.5	60.0	VESA
640x480	35.0	66.7	Macintosh
640x480	37.9	72.8	VESA
640x480	43.3	85.0	VESA
800x600	35.2	56.3	VESA
800x600	37.9	60.3	VESA
800x600	48.1	72.2	VESA
800x600	46.9	75.0	VESA
800x600	53.7	85.1	VESA
832x624	49.7	74.5	Macintosh
1024x768	48.4	60.0	VESA
1024x768	56.5	70.1	VESA
1024x768	60.0	75.0	VESA
1024x768	68.7	85.0	VESA
1280x1024	64.0	60.0	VESA

# DIMENSIONS

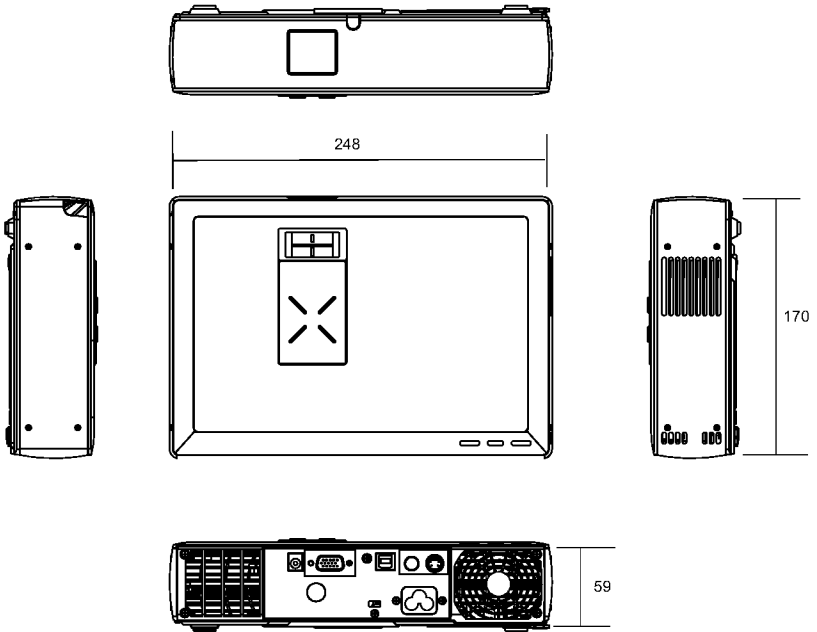

Unit: mm