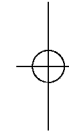
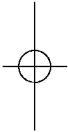

TABLE OF CONTENTS

Description of parts and controls	1
Setting up and test run	4
Cleaning and Maintenance	6
Lamp Replacement	7
Repositioning the door hinge	8



This new refrigerator was manufactured with great care and according to latest techniques.

We are confident that you will be fully satisfied with its performance and dependability.

Before you start using your refrigerator, please read this booklet carefully. It contains valuable hints about proper operation that will ensure trouble free use of the refrigerator for years to come.

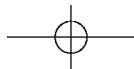

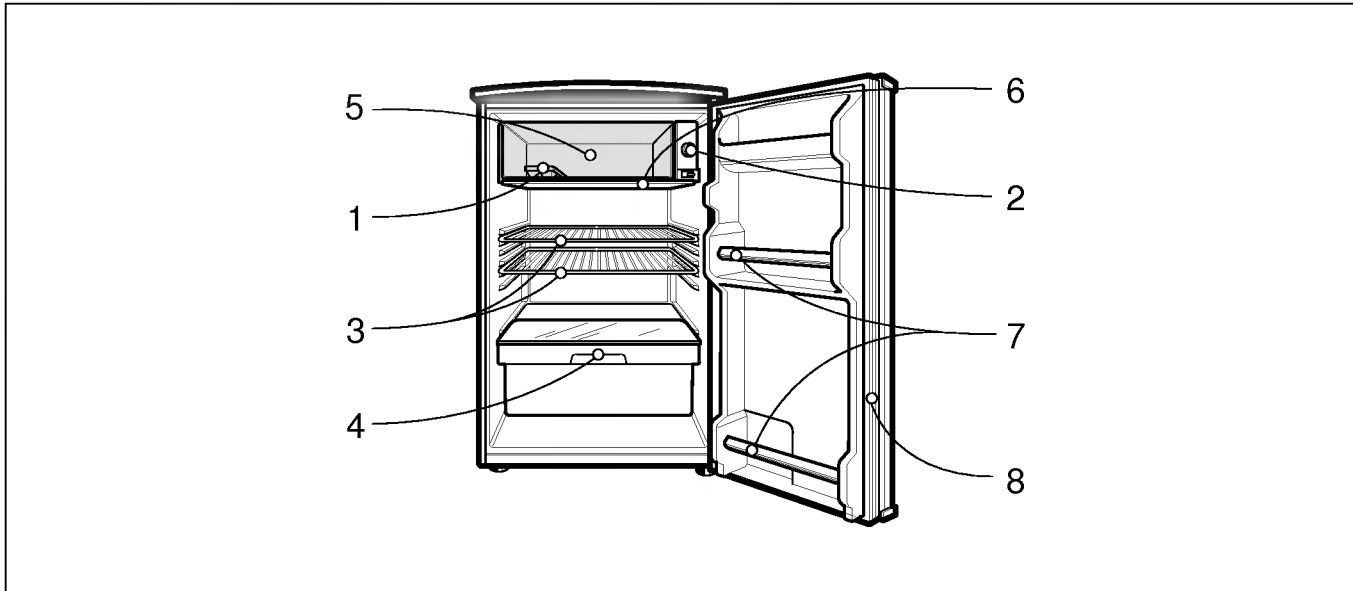
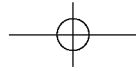

1. Ice cube tray

Ice cubes are easy to remove from the tray.

2. Thermostat dial

Regulates the operation of the motor and controls the temperature inside the refrigerator.

3. Shelves

Crisper & Glass lid For fruits and vegetables.

5. Evaporator

The heart of the refrigerator. It evaporates the refrigerant fluid and thereby absorbs heat from the surrounding. Made of pure aluminum

6. Drip Tray

Bottle rack for bottles, cans or jars.

Keeps the refrigerator virtually air-tight all along the edge, but is nevertheless easy to open.

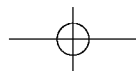

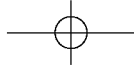

HOW TO MAKE AND REMOVE ICECUBES

To make ice cubes, fill the ice cube trays with water to slightly below the rim and place it on the evaporator. If fast cubes are required, set the control to the maximum cooling position. (Be sure to reset the control to the desired position after cubes have been produced.)

Ice cube tray is flexible. Twist tray to remove ice cubes. If the ice cube tray is frozen hard to the evaporator surface, run a little water or lukewarm water. To easily remove the ice cubes, run water on the trays before twisting.

Note:

Do not use any sharp or metallic instruments to remove ice, frost or ice cube trays from the evaporator plate. A punctured evaporator will cause serious problems and void the warranty.

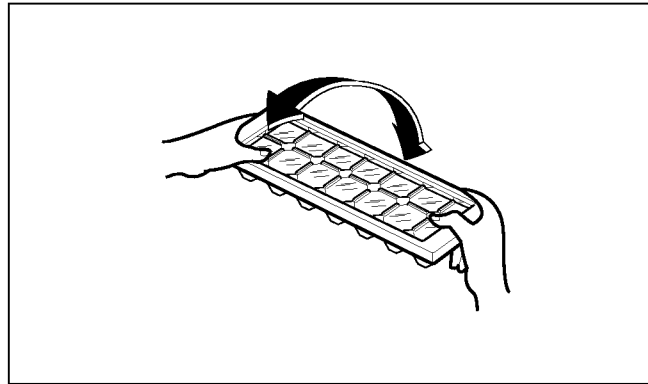

DESCRIPTION OF PARTS AND CONTROLS

3

WHEN AND HOW TO DEFROST:

For the most efficient operation of the refrigerator with the minimum electric consumption, defrost the freezer whenever the layer of ice/frost on the walls of the evaporator reaches a quarter of an inch thick.

Dial-setting defrosting

To defrost, turn the control to **0** (see fig.). Remove frozen or perishable foods and keep the drip tray in place. Defrosting usually takes a few hours, depending on the outside temperature.

To defrost quickly, remove all foods from the refrigerator and leave door open. Never use a knife or other metal instrument to remove ice from the evaporator, because this might damage the sensitive aggregate.

After defrosting, remove drip tray and dispose of water. Turn thermostat dial to desired position and refrigeration starts.

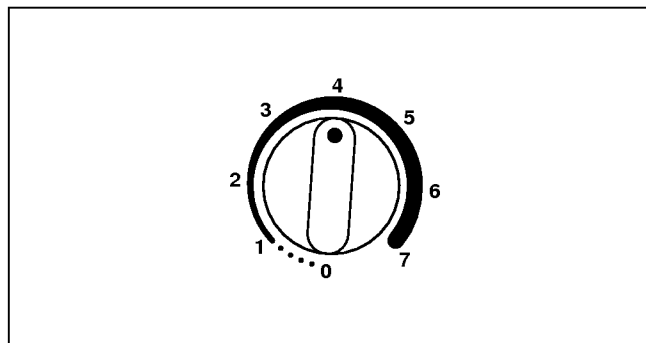

SETTING UP AND TEST RUN

4

WHERE TO PLACE YOUR REFRIGERATOR

- Select a place with strong, level floor.
- Set up the refrigerator 5 inches away from the wall.
- Since heat escapes from each side of the refrigerator, do not place it too close to the wall, or its performance will be affected (fig. 1).
- Avoid direct sunlight and heat.
Light will discolor the enamel finish. When placed in direct sunlight, close to a stove or other source of heat, the refrigerator will consume more electricity (fig. 2).
- Avoid moisture.
When placed near a sink or water faucet, the evaporator will frost faster because of the greater humidity. Defrosting will be necessary more frequently.

- Do not use an extension cord.
If possible, connect the refrigerator to its own individual appliance circuit; then other appliances or a heavy load of household lights will not cause an overload that might interrupt the electrical current. Also, a loose connection might result from doubling up with another appliance in the outlet.

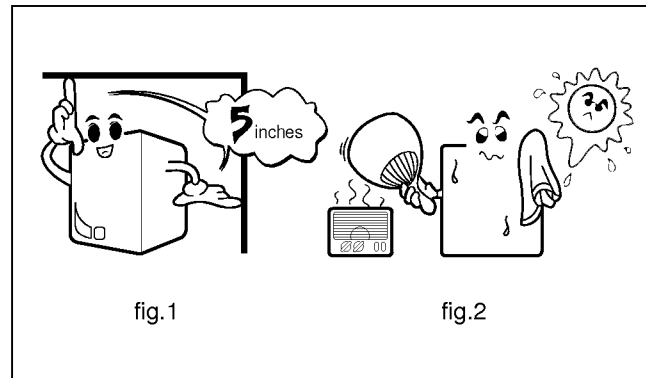
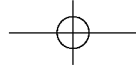

fig.1

fig.2



SETTING UP AND TEST RUN

5

TEST RUN

- Clean the refrigerator thoroughly:
Wipe the outside with a soft cloth, the inside with a wet, lukewarm cloth.
- Connect to receptacle for proper AC voltage:
Keep the door open and turn thermostat dial to **0**.
- Set the thermostat dial on **6** or **7**:
Close the door and let motor run for 15 - 20 minutes. Then open the door. The evaporator should show some traces of frost. If the motor runs smoothly with just a soft hum, operation is satisfactory.
- If test run is not satisfactory:
Check your electricity voltage. Insufficient or unstable voltage affects the performance of the refrigerator. If source of trouble cannot be located, please contact your dealer immediately.

Temperature control

You can control the inside temperature of the refrigerator by turning the thermostat dial. Smaller numbers mean less cooling power, higher numbers greater cooling power. To make ice cubes in a hurry or to keep icecream frozen in the freezer compartment, set dial to **6** or **7**. The dial does not have to be set exactly on the numbers. The thermostat does not operate in stages, but continuously.

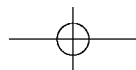
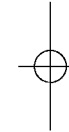
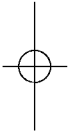

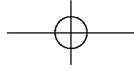

The refrigeration does not require any maintenance, because the motor is completely sealed and self-lubricating. To clean the inside of the refrigerator, use a soft cloth with water, mild soap suds, or a mild detergent. Wash ice cube trays, drip tray, and shelf in a mild solution of detergent and dry with a soft towel. Stain on the outside can also be removed with a soft towel or a mild detergent.

Note Never use brushes, gasoline, acids, chemical thinner, turpentine, or benzene for cleaning any part of the refrigerator. Boiling water or benzene is especially harmful for plastic and rubber.

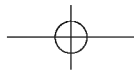
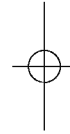
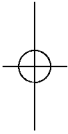
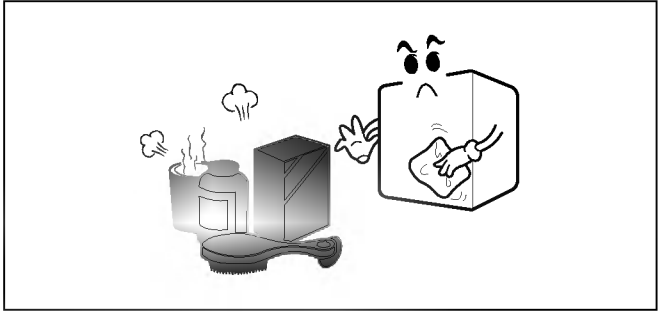

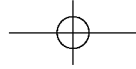

LAMP REPLACEMENT

7

1. Unplug the power cord from the outlet.
2. Remove refrigerator shelves.
3. Remove the lamp by turning it counterclockwise as shown in the figure at right.
4. Assemble in reverse order of disassembly.
Replacement bulb must be the same specification as original.

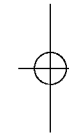
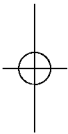
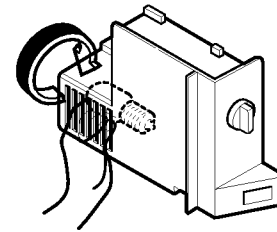

IMPORTANT WARNINGS

7

ACCESSIBILITY OF SUPPLY PLUG

The refrigerator-freezer should be so positioned that the supply plug is accessible for quick disconnection when accident happens.

SUPPLY CORD REPLACEMENT

If the supply cord is damaged, it must be replaced by the manufacturer or its service agent or a similarly qualified person in order to avoid a hazard.

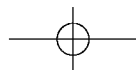

REPOSITIONING THE DOOR HINGE

8

Your Freezer is designed with a reversible door so that it may open from either left or right. It is best to reposition the door hinge as necessary at the outset since it is inconvenient to do so later.

To change the door hinge please refer to the diagram below and proceed as follows:—

1. Remove all loose fittings from inside the appliance.
2. Carefully lay the appliance on its back on the original packing (You will need assistance to achieve this). Take care not to damage the pipework by keeping it clear of the floor.
3. Unscrew and remove the Adjustable Foot (A).
4. Remove the Lower Hinge (D) by unscrewing the 2xBolts (B).
5. Remove the Leg (H) by unscrewing the bolt fixing it (C).
6. Gently pull the door downwards to remove it.
7. Before refitting the door, swap the Hinge Cap (F) by prising it from its current location and repositioning it on the other side of the door. Care should be taken not to damage the adjacent surfaces when removing the Hinge Cap.
8. Unscrew the Upper Hinge pin (G) and screw it into the opposite side hole in the top of the cabinet.
9. Now secure the Lower Hinge (D) to the cabinet using the 2xBolts (B).
10. Replace the Adjustable Foot (A), setting it at approximately 20mm.
11. Carefully stand the appliance up, (you will need assistance to do this), and position it in its permanent location.
12. Check that the door opens and closes easily. Ensure that the door seal does not bind on the hinge side creating gaps which would allow air into the interior. Adjust the hinges if necessary.

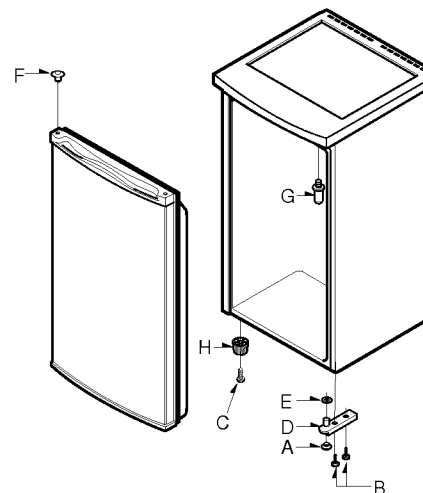

This appliance should be stood on a firm, level floor with sufficient space for free airflow around it. (At least 10mm all round and, subject to location, 20mm beneath the worksurface). Avoid positions close to walls or corners. There must be sufficient room for free ventilation particularly at the back. The unit should be located away from direct heat sources, such as cookers, radiators and direct sunlight. If the unit is positioned where the temperature is too low, condensation will form on the outside of the cabinet. Normal room temperature is recommended.

Avoid locations which may be affected by draughts or dampness as this will impair the efficiency of the product.

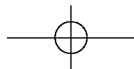

Warranty Certificate

For offer a 24-month warranty for this apparatus

During the 24-month warranty period, we will repair your apparatus at no cost to you or make available spare parts to your dealer free, if this apparatus fails due to manufacturing or material defects. Further claims are excluded. We are not liable for damages due to acts of providence or damages occurring during transport. The buyer assumes shipping and packaging costs. **Your warranty conditions on the rear also apply!**

Type of apparatus : _____

Serial number :

Name of buyer : _____

Purchase date : _____

Dealer's stamp and signature

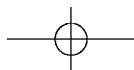
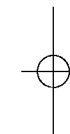
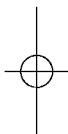

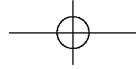

Warranty conditions for refrigerator

1. The warranty period begins on the purchase date and is valid for 24 months. Begin of warranty period is proven if, the buyer submits purchase receipt together with the warranty card, filled in and signed by the seller. The serial number of the product must agree with the number entered onto the warranty card.
2. During the warranty period, we will correct any defects at no cost to you, if it can be proven that these are attributed to manufacturing or material defects.
3. Damages due to incorrect handling, non-compliance with instructions for use and normal wear are not covered by this warranty. Also, the warranty does not cover wear parts or easily broken parts (for example, viewing glass, light bulbs). The buyer is responsible for any damages during transport as well as shipping and packaging costs.
4. We decide whether to make repairs, exchange or replace parts. Exchanged or replaced parts are our property. The original warranty period is not prolonged if a refrigerator is repaired or certain parts are replaced.
5. The warranty is nullified if any person intervenes in the apparatus that are not authorised by LG Electronics, if the apparatus is used for commercial purposes.
6. Always keep the original packaging, so that if the apparatus requires servicing, it can be transported without damaging it.
7. If a repair is covered by this warranty, always contact your dealer or an authorised service centre.
8. Further claims are excluded. If parts of these provisions are invalid, they apply in the sense of the wording. The validity of the other provisions is not effected.

